



EUROPEAN COMMISSION

Integrated Pollution Prevention and Control

Reference Document on Best Available
Techniques for the

Surface Treatment of Metals and Plastics

August 2006

This document is one of a series of foreseen documents as below (at the time of writing, not all documents have been drafted):

Reference Document on Best Available Techniques . . .	Code
Large Combustion Plants	LCP
Mineral Oil and Gas Refineries	REF
Production of Iron and Steel	I&S
Ferrous Metals Processing Industry	FMP
Non Ferrous Metals Industries	NFM
Smitheries and Foundries Industry	SF
<i>Surface Treatment of Metals and Plastics</i>	<i>STM</i>
Cement and Lime Manufacturing Industries	CL
Glass Manufacturing Industry	GLS
Ceramic Manufacturing Industry	CER
Large Volume Organic Chemical Industry	LVOC
Manufacture of Organic Fine Chemicals	OFC
Production of Polymers	POL
Chlor – Alkali Manufacturing Industry	CAK
Large Volume Inorganic Chemicals - Ammonia, Acids and Fertilisers Industries	LVIC-AAF
Large Volume Inorganic Chemicals - Solid and Others industry	LVIC-S
Production of Speciality Inorganic Chemicals	SIC
Common Waste Water and Waste Gas Treatment/Management Systems in the Chemical Sector	CWW
Waste Treatments Industries	WT
Waste Incineration	WI
Management of Tailings and Waste-Rock in Mining Activities	MTWR
Pulp and Paper Industry	PP
Textiles Industry	TXT
Tanning of Hides and Skins	TAN
Slaughterhouses and Animals By-products Industries	SA
Food, Drink and Milk Industries	FDM
Intensive Rearing of Poultry and Pigs	ILF
Surface Treatment Using Organic Solvents	STS
Industrial Cooling Systems	CV
Emissions from Storage	ESB
Reference Document . . .	
General Principles of Monitoring	MON
Economics and Cross-Media Effects	ECM
Energy Efficiency Techniques	ENE

EXECUTIVE SUMMARY

The BAT (Best Available Techniques) Reference Document (BREF) entitled ‘Surface Treatment of Metals and Plastics (STM)’ reflects an information exchange carried out under Article 16(2) of Council Directive 96/61/EC (IPPC Directive). This executive summary describes the main findings, a summary of the principal BAT conclusions and the associated consumption and emission levels. It should be read in conjunction with the preface, which explains this document’s objectives; how it is intended to be used and legal terms. It can be read and understood as a standalone document but, as a summary, it does not present all the complexities of this full document. It is therefore not intended as a substitute for this full document as a tool in BAT decision making.

Scope of this document

The scope of this document is based on Section 2.6 of Annex 1 of the IPPC Directive 96/61/EC: *‘Installations for the surface treatment of metals and plastics using an electrolytic or chemical process where the volume of the treatment vats exceeds 30 m³’*. The interpretation of ‘where the volume of the treatment vats exceeds 30 m³’ is important in deciding whether a specific installation requires an IPPC permit. The introduction to Annex I of the Directive is crucial: *‘Where one operator carries out several activities falling under the same subheading in the same installation or on the same site, the capacities of such activities are added together’*. Many installations operate a mixture of small and large production lines, and a mixture of electrolytic and chemical processes, as well as associated activities. This means that all processes within the scope, irrespective of the scale on which they are carried out, were considered in the information exchange.

In practical terms, the electrolytic and chemical processes currently used are water-based. Directly associated activities are also described. The document does not deal with:

- hardening (with the exception of hydrogen de-embrittlement)
- other physical surface treatments such as vapour deposition of metals
- hot-dip galvanising and the bulk pickling of iron and steels: these are discussed in the BREF for the ferrous metals processing industry
- surface treatment processes that are discussed the BREF for surface treatment using solvents, although solvent degreasing is referred to in this document as a degreasing option
- electropainting (electrophoretic painting), which is also discussed in the STS BREF.

Surface treatment of metals and plastics (STM)

Metals and plastics are treated to change their surface properties for: decoration and reflectivity, improved hardness and wear resistance, corrosion prevention and as a base to improve adhesion of other treatments such as painting or photosensitive coatings for printing. Plastics, which are cheaply available and easily moulded or formed, retain their own properties such as insulation and flexibility while the surface can be given the properties of metals. Printed circuit boards (PCBs) are a special case where intricate electronic circuits are manufactured using metals on the surface of plastics.

STM does not in itself form a distinct vertical sector as it provides a service to a wide range of other industries. PCBs might be considered products but are widely used in manufacturing, for example, computers, mobile phones, white goods, vehicles, etc.

The market structure is approximately: automotive 22 %, construction 9 %, food and drink containers 8 %, electrical industry 7 %, electronics 7 %, steel semis (components for other assemblies) 7 %, industrial equipment 5 %, aerospace 5 %, others 30 %. The range of components treated varies from screws, nuts and bolts, jewellery and spectacle frames, components for automotive and other industries to steel rolls up to 32 tonnes and over 2 metres wide for pressing automotive bodies, food and drink containers, etc. The transport of workpieces or substrates varies according to their size, shape and finish specification required: jigs (or racks) for single or small numbers of workpieces and high quality, barrels (drums) for many workpieces with lower quality and continuous substrates (ranging from wires to large steel coils) are processed on a continuous basis. PCBs have particularly complex production sequences. All activities are carried out using jig equipment, therefore the activities are described and discussed for jig plants, with supporting sections describing specific issues for barrel, coil and PBC processing.

While no overall figures exist for production, in 2000 the large scale steel coil throughput was about 10.5 million tonnes and about 640000 tonnes of architectural components were anodised. Another measure of the industry size and importance is that each car contains over 4000 surface treated components, including body panels, while an Airbus aircraft contains over two million.

About 18000 installations (IPPC and non-IPPC) exist in EU-15, although the loss of engineering manufacturing, largely to Asia, has reduced the industry by over 30 % in recent years. More than 55 % are specialist sub-contractors ('jobbing shops') while the remainder provide surface treatment within another installation, usually an SME. A few large installations are owned by major companies although the vast majority are SMEs, typically employing between 10 and 80 people. Process lines are normally modular and assembled from a series of tanks. However, large installations are typically specialist and capital intensive.

Key environmental issues

The STM industry plays a major role in extending the life of metals, such as in automotive bodies and construction materials. It is also used in equipment that increases safety or reduces consumption of other raw materials (e.g. plating of aerospace and automotive braking and suspension systems, plating precision fuel injectors for automotive engines to reduce fuel consumption, plating materials for cans to preserve food, etc.). The main environmental impacts relate to energy and water consumption, the consumption of raw materials, emissions to surface and groundwaters, solid and liquid wastes and the site condition on cessation of activities.

As the processes covered by this document are predominantly water-based, the consumption of water and its management are central themes, as it also affects the usage of raw materials and their loss to the environment. Both in-process and end-of-pipe techniques affect the quantity and quality of waste waters, as well as the type and quantity of solid and liquid wastes produced. Although practice and infrastructure in the industry has improved, it is still responsible for a number of environmental accidents and the risk of unplanned releases and their impacts is seen to be high.

Electricity is consumed in electrochemical reactions and to operate plant equipment. Other fuels are predominantly used for heating process vats and work space, and for drying.

The key emissions of concern to water are metals which are used as soluble salts. Depending on the process, emissions may contain cyanides (although decreasingly), as well as surfactants which may have low biodegradability and accumulative effects, e.g. NPE and PFOS. Effluent treatment of cyanides with hypochlorite may result in the production of AOX. Complexing agents (including cyanides and EDTA) can interfere with the removal of metals in waste water treatment or remobilise metals in the aquatic environment. Other ions, e.g. chlorides, sulphates, phosphates, nitrates and anions containing boron may be significant at a local level.

The STM industry is not a major source of emissions to air, but some emissions which may be locally important are NO_x, HCl, HF and acid particulates from pickling operations, hexavalent chromium mist released from hexavalent chromium plating, and ammonia from copper etching in PCB manufacture and electroless plating. Dust, as a combination of abrasives and abraded substrate, is generated by the mechanical preparation of components. Solvents are used in some degreasing operations.

Applied processes and techniques

All but a few simple activities require some pretreatment (e.g. degreasing), followed by at least one core activity (e.g. electroplating, anodising or chemical processing) and finally drying. All processes have been developed for components hung on racks or jigs; some processes are also carried out on components in rotating barrels, and a few are carried out on reels or large coils of substrate. PCBs have complex manufacturing sequences that may comprise over 60 operations. Additional information is given for barrel, coil and PCB activities.

Consumptions and emissions

The best data would relate to production throughput based on surface (m²) treated, but little is available on this basis. Most data are for emission concentrations for specific plants, or ranges for sectors or regions/countries. Apart from some cooling systems, the major use of water is in rinsing. Energy (fossil fuel and electricity) is used for heating processes and drying. Electricity is also used for cooling in some cases, as well as driving electrochemical processes, pumps and process equipment, supplementary vat heating, work space heating and lighting. For raw materials, the usage of metals is significant (although not globally, for example, only 4 % of the nickel marketed in Europe is used in surface treatment). Acids and alkalis are also used in bulk quantities, while other materials such as surfactants are often supplied in proprietary mixes.

Emissions are primarily to water, and about 300000 tonnes of hazardous waste is produced per year (an average of 16 tonnes per installation), mainly as sludge from waste water treatment or spent process solutions. There are some emissions to air of local significance, including noise.

Techniques to consider in the determination of BAT

Important issues for the implementation of IPPC in this sector are: effective management systems (including the prevention of environmental accidents and minimisation of their consequences, especially for soils, groundwater and site decommissioning), efficient raw material, energy and water usage, the substitution by less harmful substances, as well as minimisation, recovery and recycling of wastes and waste waters.

The issues above are addressed by a variety of process-integrated and end-of-pipe techniques. Over 200 techniques for pollution prevention and control are presented in this document, under the following 18 thematic headings:

1. Environmental management tools: Environmental management systems are essential for minimising the environmental impact of industrial activities in general, with some measures that are specifically important to STM, including site decommissioning. Other tools include minimising reworking to reduce environmental impacts, benchmarking consumptions, optimisation of process lines (most easily achieved with software) and process control.

2. Installation design, construction and operation: A number of general measures can be applied to prevent and control unplanned releases, and these prevent the contamination of soil and groundwater.

3. *General operational issues:* Techniques to protect the materials to be treated reduce the amount of processing required and the consequent consumptions and emissions. The correct presentation of workpieces to the process liquid reduces drag-out of chemicals from process solutions, and agitation of the solutions ensures consistent solution concentration at the surface, as well as removing heat from the surface of aluminium in anodising.

4. *Utility inputs and their management:* There are techniques to optimise electricity consumption and to optimise the amount of energy and/or water used in cooling. Other fuels are primarily used for heating solutions, using direct or indirect systems, and heat losses can be controlled.

5. and 6. *Drag-out reduction and control:* Rinsing techniques and drag-out recovery: The main source of contamination in the sector is raw materials being dragged out of process solutions by the workpieces, and into rinse-waters. The retention of materials in the processes, as well as using rinsing techniques to recover the drag-out, are crucial in reducing raw material and water consumption, as well as reducing the waterborne emissions and amounts of wastes.

7. *Other ways to optimise raw material usage:* As well as the drag-out issue (above), poor process control can lead to overdosing which increases material consumption and losses to waste waters.

8. *Electrode techniques:* In some electrolytic processes, the metal anode operates at a higher efficiency than deposition, leading to metal build-up and increased losses, which in turn increase waste and quality problems.

9. *Substitution:* The IPPC Directive requires the consideration of using less hazardous substances. Various substitution options for chemicals and processes are discussed.

10. *Process solution maintenance:* Contaminants build up in solutions by drag-in or by breakdown of raw materials, etc. Techniques are discussed to remove these contaminants which will improve finished product quality and reduce reworking for rejects, as well as saving raw materials.

11. *Process metals recovery:* These techniques are often used in conjunction with drag-out controls to recover metals.

12: *Post-treatment activities:* These include drying and de-embrittlement, although no data have been provided.

13: *Continuous coil – large scale steel coil:* These are specific techniques which apply to the large scale treatment of steel coils and are in addition to techniques in other sections which are applicable. They may also be applicable to other coil or reel-to-reel activities

14: *Printed circuit boards:* These techniques are specific to PCB manufacture, although the general discussion of techniques applies to PCB production.

15: *Air emission abatement:* Some activities have emissions to air that require controlling to meet local environmental quality standards. In-process techniques are discussed, as well as extraction and treatment.

16: *Waste water emission abatement:* Waste water and the loss of raw materials can be reduced, but very rarely to zero discharge. Additional waste water treatment techniques will depend on the chemical species present, including metal cations, anions, oils and grease, and complexing agents.

17: *Waste management:* The minimisation of waste is dealt with by drag-out control and solution maintenance techniques. The main waste streams are sludges from waste water treatment, spent solutions and wastes from process maintenance. Internal techniques can aid the use of third party recycling techniques (although these are outside the scope of this document).

18: Noise management: Good practice and/or engineered techniques can reduce noise impacts.

BAT for the surface treatment of metals and plastics

The BAT chapter (Chapter 5) identifies those techniques that are considered to be BAT in a general sense, based mainly on the information in Chapter 4, taking into account the Article 2(11) definition of best available techniques and the considerations listed in Annex IV of the Directive. The BAT chapter does not set or propose emission limit values but suggests consumption and emission values that are associated with the use of a selection of BAT.

The following paragraphs summarise the key BAT conclusions relating to the most relevant environmental issues. Although the industry is complex in size and range of activities, the same generic BAT apply to all, and other BAT are given that apply to specific processes. The BAT elements will need to be adapted to the specific installation type.

Generic BAT

It is BAT to implement and adhere to environmental and other management systems. These include benchmarking consumptions and emissions (over time against internal and external data), optimising processes and minimising reworking. BAT is to protect the environment, particularly soil and groundwaters, by using simple risk management to design, construct and operate an installation, together with techniques described in this document and in the BAT reference document on emissions from storage when storing and using process chemicals and raw materials. These BAT aid site decommissioning by reducing unplanned emissions to the environment, recording the history of usage of priority and hazardous chemicals and dealing promptly with potential contamination.

BAT is to minimise electrical losses in the supply system as well as to reduce heat losses from heated processes. For cooling, it is BAT to minimise water usage by using evaporation and/or closed loop systems, and to design and operate systems to prevent the formation and transmission of legionella.

It is BAT to minimise material losses by retaining raw materials in process vats and at the same time minimise water use by controlling the drag-in and drag-out of process solutions, as well as rinsing stages. This can be achieved by jiggling and barrelling workpieces to enable rapid draining, preventing overdosing of process solutions and using eco rinse tanks and multiple rinsing with countercurrent flows, especially with the return of rinse-water to the process vat. These techniques can be enhanced by using techniques to recover materials from the rinsing stages. The reference value for water usage using a combination of these techniques is 3 - 20 litres/m² of substrate surface/rinse stage and limiting factors for these techniques are described. Some material efficiency values associated with these retention and recovery techniques are given for a sample of installations.

In some cases, the rinse flow for a specific process in a line can be reduced until the materials loop is closed: this is BAT for precious metals, hexavalent chromium and cadmium. This is not 'zero discharge', which applies to a whole process line or installation: this can be achieved in specific cases but is not generally BAT.

Other BAT techniques to aid recycling and recovery are to identify potential waste streams for segregation and treatment, to re-use materials such as aluminium hydroxide suspension externally, and to recover externally certain acids and metals.

Executive Summary

BAT includes prevention, separation of the waste water flow types, maximising internal recycling (by treating according to the use requirements) and applying adequate treatment for each final flow. This includes techniques such as chemical treatment, oil separation, sedimentation and/or filtration. Before using new types or new sources of process chemical solutions, it is BAT to test for any possible impact on the waste water treatment system and resolve potential problems.

The following values are achieved for a sample of STM installations each using several BAT. They should be interpreted with the assistance of the comments in Chapters 3 and 4, and the guidance of the reference document on the general principles of monitoring:

Emission levels associated with some plants using a range of BAT*				
All values are mg/l	Jig, barrel, small scale coil and other processes other than large scale steel coil		Large scale steel coil coating	
	Discharges to public sewer (PS) or surface water (SW)	Additional determinands only applicable for surface water (SW) discharges	Tin or ECCS	Zn or Zn-Ni
Ag	0.1 – 0.5			
Al		1 – 10		
Cd	0.10 – 0.2			
CN free	0.01 – 0.2			
CrVI	0.1 – 0.2		0.001 – 0.2	
Cr total	0.1 – 2.0		0.03 – 1.0	
Cu	0.2 – 2.0			
F		10 – 20		
Fe		0.1 – 5	2 – 10	
Ni	0.2 – 2.0			
Phosphate as P		0.5 – 10		
Pb	0.05 – 0.5			
Sn	0.2 – 2.0		0.03 – 1.0	
Zn	0.2 – 2.0		0.02 – 0.2	0.2 – 2.2
COD		100 – 500	120 – 200	
Total Hydrocarbons		1 – 5		
VOX		0.1 – 0.5		
Suspended Solids		5 – 30	4 – 40 (surface waters only)	

*These values are for daily composites unfiltered prior to analysis and taken after treatment and before any kind of dilution, such as by cooling water, other process waters or receiving waters

Air emissions may affect local environmental quality and it is then BAT to prevent fugitive emissions from some processes by extraction and treatment. These techniques are described, with associated reference values for a sample of installations.

It is BAT to control noise by good practice techniques, e.g. closing bay doors, minimising deliveries and adjusting delivery times, or if necessary, by specific engineered solutions.

Specific BAT

It is a general BAT to use less hazardous substances. It is BAT to substitute for EDTA by biodegradable alternatives or to use alternative techniques. Where EDTA has to be used, it is BAT to minimise its loss and treat any remaining in waste waters. For PFOS, it is BAT to minimise its use by controlling additions, minimising fumes to be controlled by techniques including floating surface insulation sections: however, occupational health may be an important factor. It can be phased out in anodising and there are alternative processes to hexavalent chromium and alkali cyanide-free zinc plating.

It is not possible to replace cyanide in all applications, but cyanide degreasing is not BAT. The BAT substitutes for zinc cyanide are acid or alkali cyanide free zinc, and for cyanide copper, acid or pyrophosphate options, with some exceptions.

Hexavalent chromium cannot be replaced in hard chromium plating. BAT for decorative plating is trivalent chromium or alternative processes such as tin-cobalt, however, at an installation level there may be specification reasons such as wear resistance or colour that require hexavalent chromium processing. Where hexavalent chromium plating is used, it is BAT to reduce air emissions by techniques including covering the solution or vat and achieving closed loop for hexavalent chromium, and in new or rebuilt lines in certain situations, by enclosing the line. It is not currently possible to formulate a BAT for chromium passivation, although it is BAT to replace hexavalent chromium systems in phospho-chromium finishes with non-hexavalent chromium systems.

For degreasing, it is BAT to liaise with customers to minimise the grease or oil applied, and/or to remove excess oil by physical techniques. It is BAT to replace solvent degreasing by other techniques, usually water-based, except where these techniques can damage the substrate. In aqueous degreasing systems, it is BAT to reduce the amount of chemicals and energy used by using long-life systems with solution maintenance or regeneration.

It is BAT to increase process solution life, as well as preserving quality, by monitoring and maintaining solutions within established limits by using techniques described in Chapter 4.

For pickling on a large scale, it is BAT to extend the life of the acid by techniques including electrolysis. The acids may also be recovered externally.

There are specific BAT for anodising, including recovering the heat from sealing baths in certain circumstances. It is also BAT to recover caustic etch where there is high consumption, there are no interfering additives and the surface can meet specifications. It is not BAT to close rinse-water cycles using deionised water, because of the cross-media impacts of the regenerations.

For large scale continuous steel coil, in addition to the other relevant BAT, it is BAT to:

- use real time process controls to optimise processes
- replace worn motors by energy efficient motors
- use squeeze rollers to prevent process solution drag-in and drag-out
- switch the polarity of the electrodes at regular intervals in electrolytic degreasing and electrolytic pickling
- minimise oil use by using covered electrostatic oilers
- optimise the anode-cathode gap for electrolytic processes
- optimise conductor roll performance by polishing
- use edge polishers to remove metal build-up on the edge of the strip
- use edge masks to prevent excess metal build-up, and to prevent overthrow when plating one side only.

For PCBs, in addition to the other relevant BAT, it is BAT to:

- use squeeze rollers to prevent process solution drag-out and drag-in
- use low environmental impact techniques for inner layer bonding steps
- for dry resist: reduce drag-out, optimise the concentration and spraying of the developer and separate the developed resist from the waste water
- for etching: optimise the etchant chemical concentrations regularly, and for ammonia etching, regenerate the etching solution and recover the copper.

Emerging techniques

Some new techniques for the minimisation of environmental impacts are under development or in limited use and are considered emerging techniques. Five of these are discussed in Chapter 6: integrating the surface treatments into the manufacturing production has been successfully demonstrated in three situations but has failed to be fully implemented for various reasons. A trivalent chromium substitute process for hard chrome plating using a modified pulse current is well developed and has started pre-production verification in three typical applications. Equipment costs will be higher, but will be offset by reduced power, chemical and other costs. Substitutes for hexavalent chromium in passivation coatings are being developed to meet the requirements of two Directives. Aluminium and aluminium-alloy plating from organic electrolytes has successfully been demonstrated, but requires explosive and inflammable solvents. For PCBs, high density interconnects can use less material and imaging can be improved, with reduced chemical use, by using lasers.

Concluding remarks

The document is based on over 160 sources of information, with key information from both industry (mainly from operators rather than suppliers) and Member States. Details of data problems are given: primarily a lack of consistent quantitative information. The consumptions and emissions data given are predominantly for groups of techniques, rather than individual ones. This has resulted in some BAT being general, or no conclusions being reached, where specific conclusions would be helpful to the industry and regulators.

There was a good general level of consensus on the conclusions and no split views were recorded.

The information exchange and its result, i.e. this document, present an important step forward in achieving the integrated prevention and control of pollution from the surface treatment of metals and plastics. Further work could continue the process by providing:

- up to date information on the use of PFOS and its alternatives, as well as substitute techniques for hexavalent chromium passivation
- more quantitative data for achieved environmental benefits, cross-media effects and economics, particularly for heating, cooling, drying and water use/re-use
- further information on the emerging techniques identified in Chapter 6
- software for process optimisation for a variety of processes and in a choice of languages.

Other important recommendations beyond the scope of this BREF but arising from the information exchange are:

- the development of strategic environmental goals for the industry as a whole
- a list of industry research priorities
- organising ‘club’ or co-operative activities, in particular to deliver some of this further work
- using a ‘club’ approach to develop third party recovery for certain wastes (particularly metals and pickling acids) where in-process techniques are not available
- development of the ‘infinitely recyclable’ concept for metals and metal finishing to advise producers and consumers
- development and promotion of performance-based standards to increase acceptance of new techniques with better environmental performance.

The information exchange has also exposed some areas that would benefit from R&D projects such as:

- extension of bath life and/or metal recovery for electroless plating. These baths have very limited life and are a major source of waste metals
- techniques to measure surface area of workpieces quickly and cheaply would assist the industry in controlling more readily its processes, costs, and in turn, consumptions and emissions. The techniques should include relating surface area to other throughout measures such as metal consumption or tonnage of substrate throughput
- options for further use of modulated current techniques and equipment. This technique can overcome some of the problems of traditional steady voltage electroplating
- improved materials efficiency of some identified processes.

The EC is launching and supporting, through its RTD programmes, a series of projects dealing with clean technologies, emerging effluent treatment and recycling technologies and management strategies. Potentially these projects could provide a useful contribution to future BREF reviews. Readers are therefore invited to inform the EIPPCB of any research results which are relevant to the scope of this document (see also the preface of this document).

PREFACE

1. Status of this document

Unless otherwise stated, references to “the Directive” in this document means the Council Directive 96/61/EC on integrated pollution prevention and control. As the Directive applies without prejudice to Community provisions on health and safety at the workplace, so does this document.

This document forms part of a series presenting the results of an exchange of information between EU Member States and industries concerned on best available technique (BAT), associated monitoring, and developments in them. It is published by the European Commission pursuant to Article 16(2) of the Directive, and must therefore be taken into account in accordance with Annex IV of the Directive when determining “best available techniques”.

2. Relevant legal obligations of the IPPC Directive and the definition of BAT

In order to help the reader understand the legal context in which this document has been drafted, some of the most relevant provisions of the IPPC Directive, including the definition of the term “best available techniques”, are described in this preface. This description is inevitably incomplete and is given for information only. It has no legal value and does not in any way alter or prejudice the actual provisions of the Directive.

The purpose of the Directive is to achieve integrated prevention and control of pollution arising from the activities listed in its Annex I, leading to a high level of protection of the environment as a whole. The legal basis of the Directive relates to environmental protection. Its implementation should also take account of other Community objectives such as the competitiveness of the Community’s industry thereby contributing to sustainable development.

More specifically, it provides for a permitting system for certain categories of industrial installations requiring both operators and regulators to take an integrated, overall look at the polluting and consuming potential of the installation. The overall aim of such an integrated approach must be to improve the management and control of industrial processes so as to ensure a high level of protection for the environment as a whole. Central to this approach is the general principle given in Article 3 that operators should take all appropriate preventative measures against pollution, in particular through the application of best available techniques enabling them to improve their environmental performance.

The term “best available techniques” is defined in Article 2(11) of the Directive as “the most effective and advanced stage in the development of activities and their methods of operation which indicate the practical suitability of particular techniques for providing in principle the basis for emission limit values designed to prevent and, where that is not practicable, generally to reduce emissions and the impact on the environment as a whole.” Article 2(11) goes on to clarify further this definition as follows:

“techniques” includes both the technology used and the way in which the installation is designed, built, maintained, operated and decommissioned;

“available” techniques are those developed on a scale which allows implementation in the relevant industrial sector, under economically and technically viable conditions, taking into consideration the costs and advantages, whether or not the techniques are used or produced inside the Member State in question, as long as they are reasonably accessible to the operator;

“best” means most effective in achieving a high general level of protection of the environment as a whole.

Furthermore, Annex IV of the Directive contains a list of “considerations to be taken into account generally or in specific cases when determining best available techniques bearing in mind the likely costs and benefits of a measure and the principles of precaution and prevention”. These considerations include the information published by the Commission pursuant to Article 16(2).

Competent authorities responsible for issuing permits are required to take account of the general principles set out in Article 3 when determining the conditions of the permit. These conditions must include emission limit values, supplemented or replaced where appropriate by equivalent parameters or technical measures. According to Article 9(4) of the Directive, these emission limit values, equivalent parameters and technical measures must, without prejudice to compliance with environmental quality standards, be based on the best available techniques, without prescribing the use of any technique or specific technology, but taking into account the technical characteristics of the installation concerned, its geographical location and the local environmental conditions. In all circumstances, the conditions of the permit must include provisions on the minimisation of long-distance or transboundary pollution and must ensure a high level of protection for the environment as a whole.

Member States have the obligation, according to Article 11 of the Directive, to ensure that competent authorities follow or are informed of developments in best available techniques.

3. Objective of this Document

Article 16(2) of the Directive requires the Commission to organise “an exchange of information between Member States and the industries concerned on best available techniques, associated monitoring and developments in them”, and to publish the results of the exchange.

The purpose of the information exchange is given in recital 25 of the Directive, which states that “the development and exchange of information at Community level about best available techniques will help to redress the technological imbalances in the Community, will promote the worldwide dissemination of limit values and techniques used in the Community and will help the Member States in the efficient implementation of this Directive.”

The Commission (Environment DG) established an information exchange forum (IEF) to assist the work under Article 16(2) and a number of technical working groups have been established under the umbrella of the IEF. Both the IEF and the technical working groups include representation from Member States and industry as required in Article 16(2).

The aim of this series of documents is to reflect accurately the exchange of information which has taken place as required by Article 16(2) and to provide reference information for the permitting authority to take into account when determining permit conditions. By providing relevant information concerning best available techniques, these documents should act as valuable tools to drive environmental performance.

4. Information Sources

This document represents a summary of information collected from a number of sources, including in particular the expertise of the groups established to assist the Commission in its work, and verified by the Commission services. All contributions are gratefully acknowledged.

5. How to understand and use this document

The information provided in this document is intended to be used as an input to the determination of BAT in specific cases. When determining BAT and setting BAT-based permit conditions, account should always be taken of the overall goal to achieve a high level of protection for the environment as a whole.

The rest of this section describes the type of information that is provided in each section of this document.

Chapters 1 and 2 provide general information on the industrial sector concerned and on the industrial processes used within the sector. Chapter 3 provides data and information concerning current consumption and emission levels reflecting the situation in existing installations at the time of writing.

Chapter 4 describes in more detail the emission reduction and other techniques that are considered to be most relevant for determining BAT and BAT-based permit conditions. This information includes the consumption and emission levels considered achievable by using the technique, some idea of the costs and the cross-media issues associated with the technique, and the extent to which the technique is applicable to the range of installations requiring IPPC permits, for example new, existing, large or small installations. Techniques that are generally seen as obsolete are not included.

Chapter 5 presents the techniques and the consumption and emission levels that are considered to be compatible with BAT in a general sense. The purpose is thus to provide general indications regarding the consumption and emission levels that can be considered as an appropriate reference point to assist in the determination of BAT-based permit conditions or for the establishment of general binding rules under Article 9(8). It should be stressed, however, that this document does not propose emission limit values. The determination of appropriate permit conditions will involve taking account of local, site-specific factors such as the technical characteristics of the installation concerned, its geographical location and the local environmental conditions. In the case of existing installations, the economic and technical viability of upgrading them also needs to be taken into account. Even the single objective of ensuring a high level of protection for the environment as a whole will often involve making trade-off judgements between different types of environmental impact, and these judgements will often be influenced by local considerations.

Although an attempt is made to address some of these issues, it is not possible for them to be considered fully in this document. The techniques and levels presented in Chapter 5 will therefore not necessarily be appropriate for all installations. On the other hand, the obligation to ensure a high level of environmental protection including the minimisation of long distance or transboundary pollution implies that permit conditions cannot be set on the basis of purely local considerations. It is therefore of the utmost importance that the information contained in this document is fully taken into account by permitting authorities.

Since the best available techniques change over time, this document will be reviewed and updated as appropriate. All comments and suggestions should be made to the European IPPC Bureau at the Institute for Prospective Technological Studies at the following address:

Edificio Expo, c/Inca Garcilaso, s/n, E-41092 Sevilla, Spain
Telephone: +34 95 4488 284
Fax: +34 95 4488 426
e-mail: jrc-ipts-eippcb@ec.europa.eu
Internet: <http://eippcb.jrc.es>

Best Available Techniques Reference Document on the Surface Treatment of Metals and Plastics

EXECUTIVE SUMMARY	I
PREFACE	XI
SCOPE	XXXIII
1 GENERAL INFORMATION ON THE SURFACE TREATMENT OF METALS AND PLASTICS	1
1.1 Industries using surface treatments	2
1.2 Industry structure and economic background.....	4
1.2.1 Type and size of installations.....	4
1.2.2 Equipment lifetime.....	5
1.2.3 Technical characteristics of installations.....	5
1.2.4 Market structure	5
1.2.4.1 Competition.....	5
1.2.4.2 Extent of the market	6
1.2.4.3 Market substitutes	6
1.2.5 Summary of general economic situation.....	7
1.3 Specific industry activities	7
1.3.1 Anodising of aluminium architectural panels and profiles.....	7
1.3.2 Large scale continuous coating of steel.....	9
1.3.3 Coil and sheet anodising for lithographic (offset) printing plates.....	12
1.3.4 Continuous coil processing of aluminium.....	12
1.3.5 Printed circuit boards	12
1.4 Key environmental issues.....	14
1.4.1 Overall	14
1.4.2 Water.....	14
1.4.3 Energy.....	15
1.4.4 Substances of concern.....	16
1.4.4.1 Metals.....	18
1.4.4.2 Cyanides.....	19
1.4.4.3 Hypochlorite, chlorine and AOX	19
1.4.4.4 Surfactants.....	19
1.4.4.5 Complexing agents.....	19
1.4.4.6 Acids and alkalis	19
1.4.4.7 Other ions.....	20
1.4.4.8 Solvents.....	20
1.4.4.9 Dusts	20
1.4.4.10 Wastes	20
1.4.5 Other emissions.....	20
1.4.5.1 Noise	20
1.4.5.2 Odour	21
2 APPLIED PROCESSES AND TECHNIQUES	23
2.1 Delivery and storage – workpieces and consumable raw materials	27
2.1.1 Incoming workpiece and/or substrates to be treated	27
2.1.2 Consumable raw materials	28
2.2 Handling techniques for processing and loading for processing.....	29
2.3 Workpiece or substrate pretreatment.....	31
2.3.1 Mechanical pretreatment.....	31
2.3.1.1 Linishing and polishing.....	31
2.3.1.2 Abrasive blasting.....	32
2.3.1.3 Deburring and/or tumbling.....	32
2.3.2 Electrolytic and chemical polishing.....	32
2.3.2.1 Electropolishing	33
2.3.2.2 Electropolishing with electric discharge (also known as plasma-electrolytic polishing)	33
2.3.2.3 Electrolytic and chemical polishing processes for aluminium	34
2.3.3 Solvent degreasing.....	34

2.3.4	Aqueous cleaning	35
2.3.5	Other cleaning techniques	36
2.3.5.1	Air knives	36
2.3.5.2	Centrifuges.....	36
2.3.5.3	Dry ice	36
2.3.5.4	Hand wiping	36
2.3.6	Pickling, descaling and desmutting	37
2.3.7	Etching and descaling of aluminium	38
2.3.8	Electrolytically assisted pickling, activation and degreasing.....	38
2.3.9	Metal stripping.....	39
2.3.10	Pretreatment of plastics (etching)	39
2.3.10.1	Conditioning of plastics	39
2.3.10.2	Etching or pickling of plastic.....	40
2.4	Drag-out and rinsing	40
2.5	Core activities	41
2.5.1	Copper and copper alloy plating.....	41
2.5.1.1	Cyanide copper	42
2.5.1.2	Acid copper.....	42
2.5.1.3	Pyrophosphate copper.....	43
2.5.1.4	Brass	43
2.5.1.5	Bronze.....	43
2.5.2	Nickel electroplating.....	44
2.5.2.1	Watts-type nickel solutions.....	45
2.5.2.2	Nickel sulphamate-based solutions.....	46
2.5.2.3	Nickel chloride-based solutions.....	47
2.5.2.4	Nickel sulphate-based solutions.....	47
2.5.2.5	Other nickel plating solutions	47
2.5.2.6	Nickel alloy plating solutions	47
2.5.3	Chromium plating.....	48
2.5.3.1	Bright chromium plating (hexavalent chromium electrolytes)	49
2.5.3.2	Bright chromium plating (trivalent chromium electrolytes)	49
2.5.3.3	Black chromium plating	49
2.5.3.4	Hard chromium plating.....	50
2.5.4	Zinc and zinc alloy plating	50
2.5.4.1	Alkaline cyanide zinc	51
2.5.4.2	Alkaline cyanide-free zinc	51
2.5.4.3	Acid zinc.....	52
2.5.4.4	Zinc alloy plating.....	52
2.5.5	Cadmium plating	53
2.5.6	Tin and alloy plating.....	54
2.5.7	Precious metal plating	54
2.5.7.1	Silver.....	55
2.5.7.2	Gold	55
2.5.7.3	Palladium and alloys.....	56
2.5.7.4	Rhodium	56
2.5.7.5	Platinum.....	57
2.5.8	Autocatalytic plating (catalytic chemically reduced coatings)	57
2.5.8.1	Autocatalytic nickel on metals.....	58
2.5.8.2	Autocatalytic nickel coating for plastics.....	59
2.5.8.3	Autocatalytic copper on metals and plastics	59
2.5.9	Immersion or displacement coatings – non-catalytic chemically reduced coatings	60
2.5.10	Electropainting or electrocoating.....	61
2.5.11	Lacquering.....	62
2.5.12	Oiling	62
2.5.13	Anodising	62
2.5.13.1	Sulphuric acid anodising of aluminium	64
2.5.13.2	Chromic acid anodising of aluminium.....	65
2.5.13.3	Anodising of magnesium, titanium, tantalum and niobium	66
2.5.13.4	Phosphoric acid anodising	66
2.5.14	Colour anodising on aluminium	66
2.5.14.1	Immersion colouring.....	67
2.5.14.2	Electrolytic colouring	67
2.5.14.3	Interference colouring.....	67

2.5.14.4	Integral colouring	67
2.5.15	Sealing following anodising	67
2.5.15.1	Hot sealing	68
2.5.15.2	Cold sealing.....	68
2.5.16	Phosphating layer conversion coatings	68
2.5.16.1	Alkali phosphating	69
2.5.16.2	Zinc phosphating.....	70
2.5.16.3	Manganese phosphating	71
2.5.17	Chromium conversion coatings.....	71
2.5.17.1	Chromium (VI) conversion coatings	72
2.5.17.2	Chromium (VI) conversion coatings on electroplated zinc layers	72
2.5.17.3	Chromium (VI) conversion coatings on copper, brass and bronze.....	72
2.5.17.4	Chromium (VI) conversion coatings on aluminium.....	72
2.5.17.5	Chromium (VI) conversion coatings on magnesium and its alloys.....	73
2.5.17.6	Trivalent chromium (Cr(III)) conversion coatings on aluminium and electroplated zinc	73
2.5.17.7	Topcoatings for chromate conversion coatings.....	74
2.5.18	Metal colouring.....	74
2.5.19	Bright dipping	75
2.5.20	Chemical blacking – oxide coatings.....	75
2.5.21	Brightening	76
2.5.22	Etching – Alkaline etching of aluminium	76
2.5.23	Chemical milling.....	77
2.6	After treatment activities.....	78
2.6.1	Drying using hot water.....	78
2.6.2	Drying using hot air	78
2.6.3	Drying using air knives.....	78
2.6.4	Heat treatment for hydrogen de-embrittlement	79
2.7	Common techniques for water and waste water treatment, process solution maintenance and materials recovery	79
2.7.1	Filtration.....	79
2.7.2	Absorption techniques.....	79
2.7.3	Crystallisation	80
2.7.4	Atmospheric evaporation	80
2.7.5	Vacuum evaporation	80
2.7.6	Electrolysis – plating out.....	80
2.7.7	Electrolysis – oxidation.....	81
2.7.8	Ion exchange – resin	81
2.7.9	Electrodeionisation.....	81
2.7.10	Acid (resin) sorption	81
2.7.11	Ion exchange – liquid/liquid.....	81
2.7.12	Membrane filtration	81
2.7.13	Reverse osmosis.....	82
2.7.14	Diffusion dialysis	82
2.7.15	Membrane electrolysis	82
2.7.16	Electrodialysis.....	82
2.8	Barrel processing.....	82
2.8.1	Workpiece preparation.....	82
2.8.2	Core activities	82
2.8.3	Drying for barrelled components	83
2.9	Continuous coil – large scale steel	83
2.9.1	Entry equipment.....	84
2.9.2	Rinsing and drag-out.....	84
2.9.3	Pretreatment	84
2.9.3.1	Degreasing and cleaning	84
2.9.3.2	Pickling	85
2.9.4	Coating activities – electroplating.....	85
2.9.5	Coating activities – oiling	89
2.9.6	Layer conversion activities	89
2.9.7	After treatment activities.....	89
2.9.7.1	Drying	89
2.9.7.2	Unloading - exit looper	89
2.9.8	Continuous electrolytic zinc or zinc nickel plating activities.....	90

2.9.8.1	Entry equipment	90
2.9.8.2	Degreasing	90
2.9.8.3	Drying.....	92
2.9.8.4	Entry looper and tension leveller	92
2.9.8.5	Electrolytic degreasing	93
2.9.8.6	Pickling.....	94
2.9.8.7	Electroplating.....	95
2.9.8.8	Strip polisher.....	96
2.9.8.9	Phosphating	97
2.9.8.10	Full chromating and chromate rinsing	97
2.9.8.11	Oiling	98
2.9.8.12	Exit looper	98
2.9.9	Continuous electrolytic tin plating activities	98
2.9.9.1	Degreasing and cleaning.....	99
2.9.9.2	Pickling.....	100
2.9.9.3	Tin plating.....	101
2.9.9.4	Drag-out.....	102
2.9.9.5	Differential marking	102
2.9.9.6	Reflow – tin brightening.....	102
2.9.9.7	Passivation treatments	103
2.9.9.8	Oiling.....	104
2.9.10	Continuous electrolytic chromium plating activities (electrolytic chromium coating of steel – ECCS)	105
2.9.10.1	Degreasing and cleaning.....	105
2.9.10.2	Pickling.....	107
2.9.10.3	Chromium plating.....	107
2.9.10.4	Drag-out and rinsing.....	108
2.9.10.5	Oiling.....	108
2.9.11	Continuous electrolytic lead coating of steel	108
2.10	Sheet processing for aluminium lithography plates	108
2.10.1	Surface graining.....	109
2.10.2	Anodic oxidation (anodising)	109
2.10.3	Post-treatment.....	109
2.10.4	Coating and further processing.....	109
2.11	Printed circuit board manufacturing	110
2.11.1	Preparatory operations	114
2.11.1.1	Design of board	114
2.11.1.2	Generation of phototools (photo lab).....	114
2.11.1.3	Screen printing.....	114
2.11.2	Production steps.....	115
2.11.2.1	Mechanical and chemical preparation	115
2.11.2.2	Drilling	116
2.11.2.3	Generation of the primary image	116
2.11.2.4	Plating through holes (pth, through hole plating)	120
2.11.2.5	Electroplating of conductive pattern.....	122
2.11.2.6	Inner layer bonding adhesion.....	124
2.11.2.7	Lamination.....	124
2.11.2.8	Resist stripping	125
2.11.2.9	Etching.....	127
2.11.2.10	Tin stripping	128
2.11.2.11	Application of solder mask.....	129
2.11.3	Additional surface finishing activities	131
2.11.3.1	Solder application	131
2.11.3.2	Nickel gold and/or tin	132
2.11.3.3	Organic passivation	132
2.11.3.4	Other activities – Stripping (de-metallising) racks and plating baskets.....	132
2.12	Utility inputs	132
2.12.1	Energy	132
2.12.1.1	Electricity.....	133
2.12.1.2	Fossil fuels and process heating.....	133
2.12.1.3	Cooling of process solutions.....	134
2.12.1.4	Other energy requirements within the installation.....	134
2.12.2	Water	134

2.13	Abatement of potential releases to the environment	135
2.13.1	Waste water.....	135
2.13.1.1	Treatment techniques	137
2.13.1.2	Organic materials	137
2.13.1.3	Acids and alkalis	138
2.13.1.4	Particulate material.....	139
2.13.1.5	Metals – soluble anions.....	139
2.13.1.6	Reduction of oxidation state of metal ions.....	139
2.13.1.7	Precipitation of metallic floc.....	139
2.13.1.8	Complexing (sequestering, chelating) agents.....	141
2.13.1.9	Nitrogenous materials	141
2.13.1.10	Cyanides.....	142
2.13.1.11	Sulphide	142
2.13.1.12	Fluorides.....	142
2.13.1.13	Phosphated compounds.....	142
2.13.1.14	Other salts	142
2.13.1.15	Final cleaning of effluent (polishing).....	143
2.13.2	Wastes.....	143
2.13.2.1	Sludge dewatering.....	143
2.13.2.2	Sludge drying	143
2.13.2.3	Liquid wastes	143
2.13.2.4	Other solid wastes	143
2.13.2.5	Sludge stabilisation	144
2.13.2.6	Valorisation of wastes.....	144
2.13.3	Waste gases and other airborne emissions	144
2.13.3.1	Emission sources and types.....	144
2.13.3.2	Measures for reducing emissions	145
2.13.3.3	Extraction systems	145
2.13.3.4	Waste gas treatments.....	145
2.13.4	Noise.....	146
3	CURRENT CONSUMPTION AND EMISSION LEVELS FOR THE SURFACE	
	TREATMENT OF METALS AND PLASTICS	147
3.1	Introduction – utilities and input materials.....	147
3.2	Consumptions and emissions – utilities	148
3.2.1	Energy.....	148
3.2.2	Water.....	148
3.2.3	Consumptions and emissions – materials.....	149
3.2.3.1	Pretreatment – degreasing.....	149
3.2.3.2	Pickling	150
3.2.3.3	Rinsing	151
3.2.3.4	Core surface treatments.....	151
3.3	Overall emissions.....	154
3.3.1	Waste water.....	154
3.3.1.1	Conclusions for waste water emissions.....	161
3.3.2	Waste	164
3.3.3	Air emissions	165
3.3.3.1	Conclusions for emissions to air	174
3.3.4	Noise	178
3.4	Consumptions and emissions and for other activities	179
3.4.1	Continuous electrolytic tin coating of steel and continuous electrolytic chromium coating of steel (ECCS).....	179
3.4.2	Continuous electrolytic zinc and zinc-nickel coating of steel	181
3.4.3	Printed circuit board manufacturing.....	182
3.4.3.1	Water consumption in PCB production.....	182
3.4.3.2	Raw materials and auxiliary products used and their potential disposal.....	182
3.4.3.3	Waste water from PCB production	186
3.4.3.4	Waste from PCB production	186
3.4.3.5	Air emissions from PCB production	187
4	TECHNIQUES TO CONSIDER IN THE DETERMINATION OF BAT.....	189
4.1	Management techniques.....	190
4.1.1	Environmental management tools.....	190
4.1.1.1	Specific EMS issues for surface treatment activities.....	198

4.1.2	Reduction in reworking by process specification and quality control	199
4.1.3	Benchmarking.....	201
4.1.3.1	Benchmarking water consumption	203
4.1.4	Process line optimisation	205
4.1.5	Real time process control	206
4.2	Installation design, construction and operation.....	207
4.2.1	Pollution prevention from unplanned releases – planning, design, construction and other systems	207
4.2.1.1	Oil tight trays.....	209
4.2.2	Storage of chemicals.....	210
4.2.3	Process line type and construction.....	211
4.3	General operational issues	212
4.3.1	Protection of workpieces and substrates - before and after treatment	212
4.3.1.1	Shortening storage time	212
4.3.1.2	Storage and transport conditions.....	213
4.3.1.3	Packaging.....	213
4.3.1.4	Corrosion prevention coating with oil or grease.....	214
4.3.2	Minimisation and optimisation of coatings from previous mechanical treatments - oil and grease	215
4.3.3	Jigging	216
4.3.4	Agitation of process solutions	216
4.3.5	Maintenance – plant and equipment	217
4.4	Utility inputs and their management.....	217
4.4.1	Electricity	218
4.4.1.1	Incoming high voltage supplies and large current demands	218
4.4.1.2	DC supply	219
4.4.1.3	Energy efficient equipment.....	220
4.4.1.4	Optimising process electrical efficiency.....	220
4.4.2	Heating of process solutions.....	221
4.4.3	Reducing heating losses from process solutions.....	221
4.4.4	Cooling of process solutions.....	223
4.4.4.1	Water cooling systems.....	223
4.4.4.2	Evaporation.....	224
4.4.5	Water	225
4.4.5.1	Water supply, treatment and recycling/re-use.....	225
4.4.5.2	Control of water usage.....	226
4.4.5.3	Rinsing stages using recycled water	228
4.5	Drag-in reduction.....	229
4.6	Drag-out reduction.....	229
4.6.1	Preliminary remarks	229
4.6.2	Use of compatible chemicals.....	230
4.6.3	Reduction of drag-out – jig (rack) processing	230
4.6.4	Reduction of drag-out barrel processing.....	232
4.6.5	Properties of process solutions – effect on drag-out	235
4.6.6	Transition from drag-out draining to rinsing	236
4.7	Rinsing techniques and drag-out recovery.....	236
4.7.1	Introduction	236
4.7.2	Evaporation as a requirement for drag-out recovery	238
4.7.3	Benchmarking for rinsing.....	239
4.7.4	Eco rinse or pre-dipping.....	239
4.7.5	Spray rinsing.....	240
4.7.6	Manual or semi-automatic lines.....	241
4.7.7	Chemical rinses	242
4.7.8	Regeneration and re-use/recycling of rinsing water	243
4.7.8.1	Regeneration by ion exchange.....	243
4.7.8.2	Regeneration by reverse osmosis.....	244
4.7.9	Single rinsing techniques.....	244
4.7.10	Multiple rinse techniques.....	245
4.7.10.1	Multiple stage counterflow rinse	248
4.7.10.2	Multiple static rinse	249
4.7.10.3	Dual static rinse followed by final flow rinse with recirculated water	251
4.7.10.4	Multi-cascade rinsing with limited process line space.....	252
4.7.11	Increasing drag-out recovery rate and closing the loop.....	253

4.7.11.1	Addition of an eco rinse tank	256
4.7.11.2	Evaporation using surplus internal energy	256
4.7.11.3	Evaporation using additional energy with an evaporator	258
4.7.11.4	Electrodialysis	260
4.7.11.5	Reverse osmosis – closed loop electroplating	261
4.7.11.6	Electrolytic chromium plating - closed loop electroplating	264
4.7.12	Combining techniques and installation-wide approaches	265
4.7.13	Zero discharge	267
4.8	Other techniques to optimise raw material usage	267
4.8.1	Control of concentration of process chemicals	267
4.8.2	Different electrode yields	269
4.8.3	Switching the polarisation of the electrodes in the electrolytic processes	270
4.9	Substitution – choice of raw materials and processes	271
4.9.1	Substitution for EDTA and other strong complexing agents (chelating agents)	272
4.9.2	Substitution for, and reduction of, toxic surfactants (NPE and PFOS)	273
4.9.3	Substitution for cyanide – overview	274
4.9.4	Zinc electroplating	275
4.9.4.1	Alkaline cyanide zinc	275
4.9.4.2	Alkaline cyanide-free zinc	275
4.9.4.3	Acid zinc	276
4.9.4.4	Zinc alloys	277
4.9.5	Other cyanide - based solutions	278
4.9.6	Substitution for, and minimisation of, hexavalent chromium	278
4.9.7	Minimisation of release of hexavalent chromium from treated surfaces	279
4.9.8	Chromium electroplating techniques	280
4.9.8.1	Hexavalent chromium plating	280
4.9.8.2	‘Cold chromium’ – hexavalent process	281
4.9.8.3	Trivalent chromium chloride-based electroplating process	282
4.9.8.4	Trivalent chromium sulphate electroplating process	284
4.9.9	Chromium free processes – other coating processes	285
4.9.10	Chromium conversion coatings	287
4.9.10.1	Hexavalent chromium	288
4.9.10.2	Trivalent chromium conversion processes	288
4.9.10.3	Chromium-free conversion processes	289
4.9.11	Chromic acid anodising	290
4.9.12	Phosphochromating (phosphating with chromium)	290
4.9.13	Substitution for mechanical polishing and buffing	290
4.9.14	Substitution and choices for degreasing	291
4.9.14.1	Mechanical pre-cleaning - centrifuging	291
4.9.14.2	Solvent degreasing	291
4.9.14.3	Chemical aqueous (soak) degreasing	292
4.9.14.4	Weak emulsion degreasing	293
4.9.14.5	Biological degreasing	295
4.9.14.6	Dry ice	295
4.9.14.7	Ultrasonic cleaning	295
4.9.14.8	Electrolytic cleaning with pH control	297
4.9.14.9	High performance degreasing systems	297
4.9.15	Other degreasing techniques	298
4.9.16	Substitution by alternative processes	298
4.10	Common techniques for treating waters and aqueous solutions: feed-water, rinses, waste water treatment, process solutions, and materials recovery	300
4.11	Process solution maintenance	305
4.11.1	Filtration of process solutions	308
4.11.2	Electrodialysis	309
4.11.3	Retardation (acid resin sorbtion)	309
4.11.3.1	Retardation regeneration of sulphuric acid anodising solution	310
4.11.4	Crystallisation of carbonates and metal sulphates	311
4.11.5	Anodising caustic etch recovery	313
4.11.6	Activated carbon treatment	314
4.11.7	Ion exchange purification of metallic contamination	314
4.11.8	Electrolysis – purification of process solutions	316
4.11.9	Electrolysis – removal of surplus metal from process solutions	316
4.11.10	Electrolysis – reoxidation of breakdown products	317

4.11.11	Membrane electrolysis for chromium solution maintenance.....	317
4.11.12	Cleaning and regeneration of phosphate solutions	319
4.11.13	Maintenance of degreasing solutions.....	320
4.11.13.1	Cascade (multiple) use of degreasing solutions.....	320
4.11.13.2	Simple methods	321
4.11.13.3	Static separator for degreasing baths	321
4.11.13.4	Biological degreasing regeneration	322
4.11.13.5	Centrifuging of degreasing baths.....	325
4.11.13.6	Membrane filtration of emulsifying degreasers (micro- or ultrafiltration)	326
4.11.13.7	Multistage maintenance of degreasing solutions	328
4.11.13.8	Maintenance of electrolytic degreasing processes.....	328
4.11.14	Pickling.....	328
4.11.14.1	Measures for decreasing pickling acid consumption	329
4.11.14.2	Extension of the service life of pickling solutions by diffusion dialysis.....	330
4.11.14.3	Recovery of copper from pickling baths.....	333
4.12	Recovery of process metals	333
4.12.1	Electrolytic recovery.....	333
4.12.2	Ion exchange – recovery of precious metals from rinses.....	336
4.12.3	Chromating.....	337
4.12.4	Precipitation.....	337
4.13	Post-treatment activities – techniques relevant to the determination of BAT.....	337
4.13.1	Drying.....	337
4.13.2	De-embrittlement.....	338
4.14	Continuous coil – large scale steel coil.....	338
4.14.1	Using digital process control	338
4.14.2	Oil tight trays	339
4.14.3	Energy efficiency.....	339
4.14.3.1	Energy efficient motors	339
4.14.3.2	Raising the conductivity of the electrolyte	340
4.14.4	Water efficiency	340
4.14.4.1	Re-cycling of quench waters.....	340
4.14.4.2	Use of cascade rinse systems	340
4.14.5	Squeeze rolls.....	341
4.14.6	Electrolytic strip cleaning.....	341
4.14.7	Use of ultrafiltration systems to regenerate degreasing solution	341
4.14.8	Cascade (multiple) use of degreasing solutions.....	341
4.14.9	Control of the acid bath in the pickling section	341
4.14.10	Control and management of electrolyte consumption	342
4.14.11	Switching the polarisation of the electrodes in the electrolytic processes	342
4.14.12	Optimisation of the anode-cathode gap	343
4.14.13	Polishing the conductor roll.....	343
4.14.14	Using edge polishers.....	344
4.14.15	Using edge masks	344
4.14.16	Minimise use of oil by covered electrostatic oilers	345
4.14.17	Maintenance of process solutions.....	345
4.14.17.1	Cleaning and recirculation of degreasing baths	345
4.14.17.2	Continuous filtering and re-use of the zinc bath.....	346
4.14.17.3	Continuous removal of iron and re-use of the zinc bath	346
4.14.17.4	Cleaning and regeneration of the phosphate bath	347
4.14.17.5	Cleaning and regeneration of the chromate bath	347
4.14.18	Control of emissions to air.....	348
4.14.18.1	Collection and scrubbing.....	348
4.14.18.2	Covered treatment baths	348
4.14.19	Waste water treatment processes.....	349
4.14.20	Recovery of residual metals from tanks	349
4.15	Printed circuit board processing	349
4.15.1	Manufacture of inner layers.....	350
4.15.2	Rinsing between steps	350
4.15.3	Electroless (autocatalytic) plating.....	350
4.15.4	Electroplating PCBs	351
4.15.5	Development of dry resist by sodium carbonate.....	351
4.15.6	Etching.....	352

4.15.7	Recycling of alkali etchants online with copper recovery (liquid-liquid ion-exchange)	353
4.15.8	Resist stripping	355
4.15.9	Stripping of etch (tin) resist	355
4.15.10	Disposal of solutions	356
4.15.11	Solvent emissions from the application of solder mask	357
4.16	Waste water emission abatement techniques	357
4.16.1	Identification of problem flows	358
4.16.2	Elimination and/or separation of the individual pollutants at the point of generation	358
4.16.3	Separation of oils and greases (hydrocarbons) from waste water	360
4.16.4	Cyanide oxidation	360
4.16.5	Nitrite treatment	361
4.16.6	Chromate treatment	362
4.16.7	Flocculation and precipitation of metals	363
4.16.7.1	Hydroxide precipitation	363
4.16.7.2	Sulphide precipitation	364
4.16.7.3	Other flocculating agents	365
4.16.8	Complexing agents	365
4.16.9	Precipitation of anions	366
4.16.9.1	Fluoride precipitation	366
4.16.9.2	Phosphate precipitation	367
4.16.9.3	Sulphate precipitation	367
4.16.10	Final treatment prior to discharge	368
4.16.10.1	Sedimentation	369
4.16.10.2	Flotation	370
4.16.10.3	Filtration	371
4.16.11	Combining techniques	371
4.16.12	Zero discharge techniques	371
4.16.12.1	Thermal procedures	372
4.16.12.1.1	Vacuum evaporators with vapour compression	372
4.16.12.1.2	Infrared evaporators	373
4.16.12.2	Membrane technologies with physico-chemical processes	374
4.16.12.2.1	Treatment using ultrafiltration	374
4.16.12.2.2	Treatment using combination of ultrafiltration and reverse osmosis	375
4.16.13	Monitoring, final control and discharging of waste waters	377
4.17	Waste management techniques	378
4.17.1	Generation and management of waste	378
4.17.2	Waste minimisation and avoidance	379
4.17.3	Re-use and recycling of waste	379
4.17.4	In-house electrolytic recovery	381
4.18	Air emission abatement techniques	381
4.18.1	Additives	381
4.18.2	Air extraction, lids and treatment techniques	382
4.18.3	Reduction of the volume of extracted air	384
4.18.4	Treatment of extracted air	387
4.18.5	Air extraction control techniques	387
4.18.6	Energy recovery from extracted air	387
4.19	Noise management	388
5	BEST AVAILABLE TECHNIQUES	389
5.1	Generic BAT	391
5.1.1	Management techniques	391
5.1.1.1	Environmental management	391
5.1.1.2	Housekeeping and maintenance	392
5.1.1.3	Minimising the effects of reworking	392
5.1.1.4	Benchmarking the installation	393
5.1.1.5	Process line optimisation and control	393
5.1.2	Installation design, construction and operation	393
5.1.2.1	Storage of chemicals and workpieces/substrates	394
5.1.3	Agitation of process solutions	395
5.1.4	Utility inputs – energy and water	395
5.1.4.1	Electricity – high voltage and large current demands	395
5.1.4.2	Heating	396

5.1.4.3	Reduction of heating losses	396
5.1.4.4	Cooling	396
5.1.5	Waste minimisation of water and materials.....	397
5.1.5.1	Water minimisation in-process	397
5.1.5.2	Drag-in reduction.....	397
5.1.5.3	Drag-out reduction.....	397
5.1.5.3.1	Reduction of viscosity	398
5.1.5.4	Rinsing.....	398
5.1.6	Materials recovery and waste management	399
5.1.6.1	Prevention and reduction	400
5.1.6.2	Re-use	400
5.1.6.3	Materials recovery and closing the loop	400
5.1.6.4	Recycling and recovery	402
5.1.6.5	Other techniques to optimise raw material usage	402
5.1.7	General process solution maintenance.....	402
5.1.8	Waste water emissions.....	403
5.1.8.1	Minimisation of flows and materials to be treated.....	403
5.1.8.2	Testing, identification and separation of problematic flows	403
5.1.8.3	Discharging waste water	403
5.1.8.4	Zero discharge techniques	405
5.1.9	Waste	405
5.1.10	Air emissions	405
5.1.11	Noise.....	408
5.1.12	Groundwater protection and site decommissioning.....	408
5.2	BAT for specific processes.....	408
5.2.1	Jigging	408
5.2.2	Jig lines – drag-out reduction	409
5.2.3	Barrel lines – drag-out reduction	409
5.2.4	Manual lines	410
5.2.5	Substitution for, and/or control of, hazardous substances	410
5.2.5.1	EDTA	410
5.2.5.2	PFOS (perfluorooctane sulphonate).....	411
5.2.5.3	Cyanide.....	411
5.2.5.4	Zinc cyanide	411
5.2.5.5	Copper cyanide.....	411
5.2.5.6	Cadmium	412
5.2.5.7	Hexavalent chromium.....	412
5.2.5.7.1	Decorative chromium plating	412
5.2.5.7.2	Hexavalent chromium plating.....	413
5.2.5.7.3	Chromium conversion (passivation) coatings	413
5.2.5.7.4	Phospho-chromate finishes	413
5.2.6	Substitution for polishing and buffing.....	413
5.2.7	Substitution and choices for degreasing	413
5.2.7.1	Cyanide degreasing.....	414
5.2.7.2	Solvent degreasing.....	414
5.2.7.3	Aqueous degreasing.....	414
5.2.7.4	High performance degreasing	414
5.2.8	Maintenance of degreasing solutions.....	414
5.2.9	Pickling and other strong acid solutions – techniques for extending the life of solutions and recovery	414
5.2.10	Recovery of hexavalent chromating solutions.....	415
5.2.11	Anodising	415
5.2.12	Continuous coil – large scale steel coil.....	415
5.2.13	Printed circuit boards (PCBs).....	416
6	EMERGING TECHNIQUES FOR THE SURFACE TREATMENT OF METALS AND PLASTICS	417
6.1	Process-integrated automated plating	417
6.2	Substitution by trivalent chromium plating for hexavalent chromium in hard chromium applications using modified pulse current	418
6.3	Substitution by chromium (III) conversion coatings for chromium (VI) conversion layers.....	420
6.4	Aluminium and aluminium alloy plating from organic electrolytes	421
6.5	Printed circuit boards.....	422

6.5.1	Laser direct imaging.....	422
6.5.2	High density interconnects (HDI).....	422
6.5.3	Embedded passives.....	423
7	CONCLUDING REMARKS.....	425
7.1	Timing of the work.....	425
7.2	Sources of information.....	425
7.3	Degree of Consensus reached.....	426
7.4	Recommendations for future work.....	426
7.5	Suggested topics for future R&D projects.....	429
	REFERENCES.....	431
	GLOSSARY.....	439
8	ANNEXES.....	453
8.1	Metals and compounds in relevant legislation and agreements.....	453
8.2	PFOS (perfluorooctane sulphonate) in the surface treatment of metals and plastics.....	455
8.3	Examples of regulatory emission limit values.....	456
8.3.1	Regulations applicable to surface treatment activities in France.....	458
8.4	Monitoring.....	461
8.4.1	General issues for monitoring in the surface treatment of metals and plastics.....	461
8.4.1.1	Organic carbon.....	461
8.4.1.2	Air monitoring.....	461
8.4.2	Self monitoring of aqueous effluents from the surface treatment of metals and plastics.....	461
8.5	Reference plants in Germany.....	466
8.5.1	Reference plant A.....	466
8.5.2	Reference plant C.....	474
8.5.3	Reference Plant D.....	478
8.5.4	Reference Plant E.....	482
8.5.5	Reference Plant F.....	488
8.5.6	Reference Plant G.....	494
8.5.7	Reference plant H.....	500
8.5.8	Reference plant K.....	506
8.5.9	Reference Plant L.....	512
8.6	Chromium usage for typical small decorative plating lines.....	519
8.7	Ion exchange – general description of techniques.....	520
8.8	Ultrasonic cleaning – example plants.....	524
8.9	Example plant for the reduction of the volume of extracted air.....	525
8.10	Table of comments on the use of hexavalent and trivalent chromium.....	527
8.11	Example of plant optimisation calculations.....	531
8.12	Example calculation of the cost benefit of reducing NO _x emissions from aluminium brightening.....	541
8.13	Waste water minimisation and waste water-free electroplating in Germany.....	543

List of figures

Figure 1.1: Total production of coatings for aluminium	7
Figure 1.2: Total European aluminium surface finishing of architectural profiles.....	8
Figure 1.3: Leading anodising countries in Europe.....	8
Figure 1.4: Steel for packaging (tin plate and ECCS) production in EU-15 (in kt)	9
Figure 1.5: Main consuming industries for tin plate and ECCS outputs	10
Figure 1.6: Production of continuous electrolytic zinc/zinc-nickel in EU-15 (in kt)	11
Figure 1.7: Production of continuous zinc and zinc-nickel coating steel in EU-15 (in kt).....	11
Figure 1.8: World market for PCBs 1999 – 2002 per regions, value in million USD.....	12
Figure 1.9: Number of PCB manufacturers in Europe by turnover.....	13
Figure 1.10: Industry sectors served by European PCB production in 2002.....	13
Figure 2.1: A simplified process line workflow diagram.....	23
Figure 2.2: Example of a jobbing shop layout	24
Figure 2.3: Common route in Chapter 2 for workpieces and substrates and the activity descriptions	25
Figure 2.4: Automotive body undergoing spray pre-treatment	28
Figure 2.5: Jig or rack plating: unloading finished components	30
Figure 2.6: Linishing	31
Figure 2.7: Section through a jig plating process line for PCB production.....	41
Figure 2.8: Example of mirror processing line.....	61
Figure 2.9: Example of decorative anodising process options	63
Figure 2.10: Typical anodising plant layout.....	65
Figure 2.11: Outline of typical coil coating process.....	84
Figure 2.12: Vertical cell.....	87
Figure 2.13: Radial cell.....	87
Figure 2.14: Horizontal cell	88
Figure 2.15: Schematic of an electrolytic zinc coating line layout.....	90
Figure 2.16: Spray degreasing and brushing	91
Figure 2.17: Spray rinsing	92
Figure 2.18: Electrolytic degreasing	93
Figure 2.19: Pickling section.....	95
Figure 2.20: Schematic of a tin coating line layout.....	99
Figure 2.21: Schematic of a cleaner section.....	100
Figure 2.22: Schematic of a pickler section	100
Figure 2.23: Schematic of a plating tank – vertical cell	101
Figure 2.24: Schematic of flow-melt section	103
Figure 2.25: Schematic of passivation treatment	104
Figure 2.26: Chrome coating line layout.....	105
Figure 2.27: Typical arrangement of ECCS line	106
Figure 2.28: Examples of printed circuit board construction	111
Figure 2.29: Flow diagram of typical printed circuit board production process sequence.....	113
Figure 2.30: Application of dry resist	118
Figure 2.31: Exposure of resist	118
Figure 2.32: Development of resist	119
Figure 2.33: Copper electroplating.....	122
Figure 2.34: Tin electroplating.....	123
Figure 2.35: Schematic of a multilayer board	125
Figure 2.36: Stripping of dry film	126
Figure 2.37: Etching.....	127
Figure 2.38: Stripping of tin resist.....	129
Figure 2.39: Coating with solder mask	130
Figure 2.40: Curtain application by and curing of solder mask	130
Figure 2.41 Hot air levelling	131
Figure 2.42: Flow diagram for a typical waste water treatment plant	137
Figure 2.43: Example of waste water treatment plant using ion exchange	139
Figure 2.44: Variation of solubility of dissolved metal with pH.....	140
Figure 3.1: Continuous mass stream overview of tin plate and ECCS.....	179
Figure 3.2: Continuous coating mass stream overview for zinc and zinc-nickel	181
Figure 4.1: Definition of rinse stage.....	204
Figure 4.2 Encapsulated integrated chromium plating line.....	211
Figure 4.3: Example of locking flow valve.....	227

Figure 4.4: Drop of chemical concentration in process solution due to drag-in of rinse-water and drag-out of process solution without replenishing	237
Figure 4.5: Drag-out recovery through eco rinse	239
Figure 4.6 Manual spray rinsing	240
Figure 4.7: Multi-level rinsing technology (cascade technology).....	246
Figure 4.8: Recovery of drag-out with a triple counter flow rinse.....	248
Figure 4.9: Specific water consumption 'w' of triple and quadruple counterflow rinses	249
Figure 4.10: Recovery of drag-out with triple static rinse	250
Figure 4.11: Specific water consumption in litre per litre of drag-out W_1 triple static vs. W_2 triple counter flow rinse	250
Figure 4.12: Dual static rinse followed by single flow rinse with recirculated water, continuously purified in ion exchangers (IEX).....	251
Figure 4.13: Increase of chemical concentration C_1 and C_2 related to number of rinsed barrels.....	252
Figure 4.14: External cascade system: Single spray compartment with external cascade and concentrate recycling	253
Figure 4.15: Rinse-water and chemical recovery through concentration.....	254
Figure 4.16: Specific water evaporation from process solutions, with fume extraction at the process tank	257
Figure 4.17: Schematic diagram of the evaporator	259
Figure 4.18: Operational principle of the electrical dialysis	260
Figure 4.19: Reverse osmosis plant	261
Figure 4.20: Removal of metal lost in rinsing prior to ion exchange.....	266
Figure 4.21: Weak emulsion degreasing system with holding tank for cleaning.....	294
Figure 4.22: Filtration of process solutions	308
Figure 4.23: Retardation process	309
Figure 4.24: Operating principle of cold crystallisation	312
Figure 4.25: Chromic acid electrolyte regeneration by ion exchange.....	315
Figure 4.26: Electrolytic removal of surplus and contaminating metals.....	316
Figure 4.27: Biological aqueous degreasing process	323
Figure 4.28: Bypass microfiltration for extending the service lifetime extension of a degreasing solution	326
Figure 4.29: Regeneration of pickling solutions by dialysis.....	331
Figure 4.30: Optimised cell using fluidised bed technology.....	334
Figure 4.31: Recycling of alkali etchant in printed circuit board manufacture.....	354
Figure 4.32: Treatment using a combination of ultrafiltration and reverse osmosis.....	376
Figure 4.33: Jig line with lids on vats and air extraction	382
Figure 4.34: Example of fume extraction on top of treatment tank	384
Figure 4.35: Single-sided extraction ($W < 0.5$ m)	385
Figure 4.36: Double-sided extraction ($W > 0.5$ m).....	385
Figure 4.37: Lid protecting free surface area, fixed to and moved with the flight bar.....	385
Figure 4.38: Lid protecting free surface area above extraction hood, movable by the transporter	386
Figure 8.1: Plant A process flow diagram	467
Figure 8.2: Plant A nickel inputs	473
Figure 8.3: Plant A nickel outputs	473
Figure 8.4: Plant C process flow diagram.....	475
Figure 8.5: Plant C waste water treatment plant flow diagram.....	477
Figure 8.6: Plant D process flow diagram	480
Figure 8.7: Plant D waste water treatment flow diagram.....	481
Figure 8.8: Plant E process flow diagram.....	483
Figure 8.9: Plant E waste water treatment plant flow diagram	485
Figure 8.10: Plant E zinc emissions.....	487
Figure 8.11: Plant F process flow diagram	489
Figure 8.12: Plant F waste water treatment flow diagram	492
Figure 8.13: Plant G process flow diagram	495
Figure 8.14: Plant G waste water treatment plant flow diagram.....	498
Figure 8.15: Plant H process flow diagram	501
Figure 8.16: Plant H waste water treatment plant flow diagram.....	504
Figure 8.17: Plant K process flow diagram	508
Figure 8.18: Plant K six step cascade rinse.....	510
Figure 8.19: Plant K waste water treatment plant flow diagram.....	511
Figure 8.20: Plant L process flow diagram.....	513
Figure 8.21: Plant L waste water treatment plant flow diagram	517
Figure 8.22: UK industry average plant schematic.....	531

Figure 8.23: Industry optimised ‘good practice’ plant, SE2000.....	531
Figure 8.24: Summary of improvements made from average (benchmark) plant to good practice	532
Figure 8.25: Page showing where standard factors are entered for calculation.....	533
Figure 8.26: Page setting drag-out rates.....	533
Figure 8.27: Alkaline cleaning station	534
Figure 8.28: Pickling station	535
Figure 8.29: Post-pickle rinsing; comparison of operation and costs for average and good practice plants and payback period.....	536
Figure 8.30: Electrocleaning station.....	537
Figure 8.31: Plating station and rinses	538
Figure 8.32: Chiller requirements of plating station.....	539
Figure 8.33: After passivation rinsing.....	540

List of tables

Table 1.1: Examples of key treatments and their uses	3
Table 1.2: Production tonnages for the year 2000 for both tin plate and ECCS by country in EU-15	9
Table 1.3: Number of continuous lines producing both tin plate and ECCS in EU-15	10
Table 1.4: Key substances of concern across the sector and media potentially affected	17
Table 2.1: Zinc and zinc alloy layer thickness as a function of industry application.....	88
Table 2.2: Gaps between anode and steel strip for different electrolytic cell types	89
Table 2.3: Comparison of resist layer types for primary imaging	117
Table 2.4: Comparison of desmearing processes.....	121
Table 3.1: Energy losses at the surface of hot process solutions in watts/m ²	148
Table 3.2: Specific consumption of degreasing chemicals	150
Table 3.3: Specific consumption of pickling agent.....	150
Table 3.4 Metal losses from pickling and related processes.....	150
Table 3.5: Metal losses from coating processes.....	151
Table 3.6: Specific consumption of electrolyte	151
Table 3.7 Efficiency benchmarks for different zinc plating installations	152
Table 3.8 Phosphating efficiencies and losses in the automotive industry	152
Table 3.9: Process efficiencies with respect to input materials.....	153
Table 3.10: Data sources and types for waste water discharges	154
Table 3.11: ACEA emission values for phosphating plants	155
Table 3.12: CETS Netherlands (VOM) Flow and load data for a contract plater.....	156
Table 3.13: Finnish phosphate emission values.....	156
Table 3.14: Heavy metal loads from electroplating installations to municipal sewerage systems.....	157
Table 3.15: German reference plants in Annex 8.5: percentage of input metals discharged in waste water	157
Table 3.16: Summary data from German surface treatment waste water samples	158
Table 3.17: Summary data for waste water samples for a Netherlands factory	159
Table 3.18: Summary of Swedish waste water data from nine installations.....	160
Table 3.19: UK data for emission values to waste water from 30 IPPC permit applications	161
Table 3.20: Summary data for emission ranges to water including values associated with potential BAT	163
Table 3.21: Solutions and activities which may require prevention of fugitive emissions.....	166
Table 3.22: Data sources and types for air emissions	167
Table 3.23: Emissions to air from alkali zinc barrel and copper-nickel barrel lines, Austria	167
Table 3.24: Emission to air CETS Netherlands	168
Table 3.25: Emissions to air from trivalent chromium plating	169
Table 3.26: Air emission values for examples of pickling and chromium plating plants in Germany	172
Table 3.27: Air emission values for examples of activities for the surface treatment of metals in Sweden	173
Table 3.28: Summary data for emission ranges to air from some installations	177
Table 3.29: Typical input and consumption levels for continuous steel coating by electrolytic tin or ECCS	180
Table 3.30: Typical emission values for continuous steel coating by electrolytic tin or ECCS	180
Table 3.31 Typical consumption and emission levels for continuous steel coating by zinc and zinc nickel	182
Table 3.32: Printed circuit boards: summary of types of consumptions and waste outputs.....	185
Table 3.33: Wastes arising from PCB manufacture.....	186
Table 3.34: Air emissions from PCB production.....	187
Table 4.1: Information breakdown for each technique described in this chapter	189
Table 4.2: Withdrawal and dwell times for jigs.....	231
Table 4.3: Withdrawal and dwell times for barrels.....	234
Table 4.4: Drag-out retention, barrel diameter 380 mm with 8 mm holes.....	234
Table 4.5: Drag-out retention, barrel diameter 380 mm with 2 mm holes.....	234
Table 4.6: Some recommended rinse ratios.....	237
Table 4.7: The rinsing ratio is a function of a specific rinsing quantity of water (expressed as litres of rinsing water per litre of dragged-out electrolyte) given and the number of cascades.....	246
Table 4.8: Achievable recovery rates for some multiple rinse techniques.....	247
Table 4.9 Process solutions using cyanide.....	278
Table 4.10: Release of chromium (VI) from treated substrate.....	279
Table 4.11: Summary of non-chromium substitutes for hard and decorative chromium baths	286
Table 4.12: Sections discussing the application of treatment techniques	300

Table 4.13: Common techniques for treating aqueous systems	304
Table 4.14: Examples of techniques applied for maintenance of process solutions.....	307
Table 4.15: Techniques for degreasing solution maintenance.....	320
Table 4.16: Results of the dialysis treatment on etching solutions.....	331
Table 4.17: Typical capital and operating costs for a fluidised bed electrolytic cell.....	335
Table 4.18: Solubility products of metal hydroxides and sulphides.....	364
Table 4.19: Typical composition of electroplating sludge from different sources	379
Table 5.1: Levels for in-process materials efficiency.....	400
Table 5.2: Emission ranges to water associated with some BAT for some installations.....	404
Table 5.3: Solutions and activities which may require prevention of fugitive emissions	406
Table 5.4: Indicative emission ranges to air achieved by some installations	407
Table 6.1: Comparison of hard chromium plating by traditional Cr(VI) and modified pulse current Cr(III)	418
Table 8.1: Metals and compounds in relevant legislation and agreements	454
Table 8.2: Emission limit values for surface treatment waste water in Europe (values in mg/l) (CETS)	456
Table 8.3: Helsinki Water Co. and Helcom emission limit values for industrial waste waters.....	457
Table 8.4: Air pollutants in surface technology	457
Table 8.5: Typical limit values for discharge of waste waters from PCB manufacture to public sewer	458
Table 8.6: Typical values addition parameters for discharge from PCB manufacture to watercourse....	458
Table 8.7: Plant A input materials.....	468
Table 8.8: Plant A service lifetime of the feeds, cycles of monitoring and refill of chemicals	469
Table 8.9: Plant A service life of the process baths	469
Table 8.10: Plant A emission levels for heavy metals.....	471
Table 8.11: Plant A waste quantities.....	471
Table 8.12: Plant A metal constituents of electroplating sludge	472
Table 8.13: Plant D metals losses to waste water and waste	482
Table 8.14: Plant E input materials	484
Table 8.15: Plant E service life of the solutions – cycle of the monitoring and refill of chemicals	484
Table 8.16: Plant E waste water emission values for heavy metals	486
Table 8.17: Plant E waste produced.....	486
Table 8.18: Plant E unit costs per m ²	487
Table 8.19: Plant F input materials	488
Table 8.20: Plant F chemicals used in waste water treatment	490
Table 8.21: Plant F service lifetime of process solutions	490
Table 8.22: Plant F heavy metals in the waste water.....	491
Table 8.23: Plant F sludge details	492
Table 8.24: Plant F metal concentrations the sludge	493
Table 8.25: Plant G input materials.....	496
Table 8.26: Plant G cycle of monitoring and refill of chemicals.....	497
Table 8.27: Plant G service lifetime of the process solutions.....	497
Table 8.28: Plant G waste water emission values for heavy metals	498
Table 8.29: Plant G composition of the waste water treatment sludge.....	499
Table 8.30: Plant G costs per tonne and per m ² processed.....	500
Table 8.31: Plant H input material	502
Table 8.32: Plant H top up cycle and service lifetime of the process solutions	503
Table 8.33: Plant H metal concentrations in the waste water.....	504
Table 8.34: Plant H waste quantities.....	505
Table 8.35: Plant H consumption costs EUR/m ²	506
Table 8.36: Plant K input material	507
Table 8.37: Plant K service lifetime of the process solutions.....	509
Table 8.38: Plant K cycle of monitoring and refill of chemicals.....	509
Table 8.39: Plant K waste quantities	511
Table 8.40: Plant L input material for plating and waste water treatment.....	514
Table 8.41: Plant L analytic control, refill cycle and service lifetime of the process solutions	515
Table 8.42: Plant L concentration of heavy metals in the waste water after treatment	516
Table 8.43: Plant L waste-quantities	517
Table 8.44: Plant L composition of electroplating sludge for metallurgical recycling.....	518
Table 8.45: Plant L costs as EUR/m ² treated	518
Table 8.46: Typical ion exchange capacities for general resin types (in milliequivalents per litre, meq/l)	522
Table 8.47: Selective catalytic reduction (SCR) of NO _x : Cost in EUR (2001).....	542

SCOPE

The scope of this document is based on Section 2.6 of Annex 1 of the IPPC Directive 96/61/EC: *'Installations for the surface treatment of metals and plastics using an electrolytic or chemical process where the volume of the treatment vats exceeds 30 m³'*.

The interpretation of 'where the volume of the treatment vats exceeds 30 m³' is important in deciding whether a specific installation requires an IPPC permit. This document does not address this issue of interpretation. The technical working group discussed this definition and accepted that the 30m³ threshold is the total of the volume of all the process tanks in the installation. This included sprays, although there were differing opinions on including degreasing activities.

Many installations operate a mixture of small and large production lines, and a mixture of electrolytic and chemical processes, as well as associated activities. Point 2 of Annex 1 of the Directive notes: *'Where one operator carries out several activities falling under the same subheading in the same installation or on the same site, the capacities of such activities are added together'*. This means that all processes within the scope, irrespective of the scale on which they are carried out, were considered in the information exchange.

In practical terms, the electrolytic and chemical processes currently used are water-based. Directly associated activities are also described. This document does not deal with:

- hardening (with the exception of hydrogen de-embrittlement, where it is carried out in conjunction with electroplating)
- other physical surface treatments such as vapour deposition of metals
- hot-dip galvanising and the bulk pickling of iron and steels are discussed in the reference document on Best Available Techniques in the ferrous metals processing industry
- surface treatment processes that are discussed in the reference document on Best Available Techniques for surface treatment using solvents, although solvent degreasing is also briefly discussed in this document as a degreasing option
- electropainting (electrophoretic painting) is discussed in the reference document on Best Available Techniques for surface treatment using solvents.

1 GENERAL INFORMATION ON THE SURFACE TREATMENT OF METALS AND PLASTICS

Treating the surfaces of metals

The surface treatment of and by metals dates back to early man using gold decoratively before 4000 BC. Gold and silver plating (including their deposit from amalgams) was well-known by the 13th century AD, and tin plating of iron was carried out in Bohemia in 1200 AD. In the mid-19th century, the electrodeposition of metals was discovered enabling new possibilities, which are still being extended [4, Cramb, , 5, Hook and Heimlich, 2003, 41, 2003].

The surface properties of metals are typically changed for:

- decoration and/or reflectivity
- improved hardness (to maintain cutting edges and resistance to damage and wear)
- prevention of corrosion.

Currently, the main areas of application are: automotive and transportation, packaging, building and construction (for more information, see Section 1.1) [118, ESTAL, 2003]. Two further commercial areas of application have emerged since the 1960s:

- in microelectronics, especially with the advent of telecommunications and microprocessor controls in many common appliances. These demand mass-produced components with high conductivity capable of carrying very small electrical currents. This is achieved by applying precious metal plating on cheaper substrates
- in printing, where aluminium is usually the substrate of choice for lithographic plates. The aluminium is first treated by electrochemical graining and anodic oxidation (anodising) prior to photosensitive treatments.

Treating the surfaces of plastics

Plastics are now widely used in their own right and not only to replace metals. However, although they can be easily formed, may be flexible or rigid, and are corrosion-resistant and insulating, they lack other desirable properties. This has led to demands to change the surface properties of these new materials for:

- decoration, to achieve a high value, metal-like appearance similar to gold, brass, and chromium
- reflectivity, similar to chromium
- durability, as plastics are generally softer than metals
- electrical conductivity, usually in selected areas.

These requirements are met by depositing layers of metals on the surface of the plastic.

Printed circuit boards are a specific case, where intricate electronic circuits are manufactured using metals on the surface of a plastic – usually resin or glass fibre board but also plastic films. A complicated series of processes removes and adds successive layers of metals as circuits to connect small holes. The inside surface of these holes are also coated with metal during the processes to enable electronic components to be subsequently soldered into them.

1.1 Industries using surface treatments

The surface treatment of metals and plastics does not itself form a distinct vertical industry sector. Surface treatments do not create products; they change the surface properties of previously formed components or products for subsequent use. Printed circuit boards might be considered products but are components manufactured for use in other products, and are made by a considerable number of interdependent manufacturing stages. The surface treatment of metals and plastics is therefore largely a service to many industries and examples of key customers are given below:

- automotive
- aerospace
- information systems
- telecommunications
- heavy engineering
- construction (building)
- bathroom fittings
- hardware
- food and drink containers
- printing
- domestic appliances
- jewellery, spectacles and ornaments
- furniture
- clothing
- coinage
- medical.

The market structure in volume is approximately: automotive 22 %, construction 9 %, food and drink containers 8 %, electric industry 7 %, steel semi product 7 %, electronic industry 7 %, industrial equipment 5 %, aerospace industry 5 %, unspecified 30 % [121, France, 2003]. Table 1.1 sets out examples of key treatments and their uses.

Treatment type	Substrate	Example workpieces	Effect achieved
Zinc plating and chromium passivation	Steel	Fastenings (nuts, bolts, screws, nails, specialist design, etc.) for construction, automotive, furniture. Automobile brake system components, windscreen washer system components. Chassis and casings for domestic goods (TVs, Hi-fis, videos, washing machines, fridges).	<ul style="list-style-type: none"> corrosion protection decoration
Hard chromium plating	Steel	Heavy duty engines (marine, etc.). Rolling mill bearings (steel and non-ferrous metal). Rollers (in paper mills). Aerospace undercarriage and control components. Medical equipment. Automotive shock absorbers [157, ACEA, 2004].	<ul style="list-style-type: none"> durability prevention of sticking micro-smooth surface
Chromium plating	Steel coil	Food, domestic and commercial products packaging (cans)	<ul style="list-style-type: none"> corrosion protection decoration
Nickel, autocatalytic plating (for subsequent chromium plating)	Plastic, steel, aluminium, etc.	Bathroom fittings. Furniture fittings. Textile and printing machinery. Automotive trim [124, Germany, 2003].	<ul style="list-style-type: none"> decoration corrosion protection
Nickel, electrolytic	Steel	Coins (all EU currencies). Fittings (screws, etc.). Automotive trim [157, ACEA, 2004].	<ul style="list-style-type: none"> corrosion protection decoration
Copper and copper alloy (brass) plating	Steel	Coins (all EU currencies). Fittings.	<ul style="list-style-type: none"> decoration
Cadmium plating	Steel	Aerospace fittings.	<ul style="list-style-type: none"> corrosion prevention prevention of sticking
Gold plating	Copper, printed circuit boards	Connectors and wires for telecommunications and IS hardware.	<ul style="list-style-type: none"> corrosion prevention high conductivity
Precious metal plating (gold, silver, iridium, platinum)	Steel, copper, brass, alloys	Jewellery, ornaments (hollowware), spectacle frames.	<ul style="list-style-type: none"> decoration corrosion prevention
Anodising	Aluminium	Automotive components [111, ACEA, 2003]. Aerospace wing and fuselage panels. Building door and window frames, cladding panels. Packaging and consumer goods.	<ul style="list-style-type: none"> corrosion protection decoration (with or without colour)
Hard anodising	Aluminium	Bearing surfaces in turbine compressor housings for automotive engines.	<ul style="list-style-type: none"> durability, increased hardness
Conversion coatings, such as phosphating, chromating and others [118, ESTAL, 2003]	Steel, aluminium and other metals	Nuts, bolts, screws, tubes. Engine pinions, camshafts, pistons, gears, valves. Cold forming of wires, tubes, etc. Food and domestic goods packaging. Automotive bodies and panels [111, ACEA, 2003]. Domestic electrical goods, etc.	<ul style="list-style-type: none"> corrosion protection durability (surface lubrication for cold drawing, or forming) overcomes surface irregularities adhesion of paints
Printed circuit boards (tin and copper plating, etching, etc.)	Copper on plastics	Control systems for aerospace, automotive products (engine management, braking, etc.), telecommunications and IS, domestic goods.	<ul style="list-style-type: none"> circuit systems

Table 1.1: Examples of key treatments and their uses

1.2 Industry structure and economic background

1.2.1 Type and size of installations

The surface treatment of metals and plastics discussed in this document is carried out in more than 18300 installations (both IPPC and non-IPPC) in Europe, ranging from small private companies to facilities owned by multinational corporations. The large majority are small or medium enterprises (SMEs, [61, EC, 2002]); in Germany the typical number of employees is between 10 and 80. Altogether, the industry for the surface treatment of metals and plastics employs about 440000 people in Europe. These figures include manufacturers of printed circuit boards. More than 10000 (55 %) are specialist surface treatment installations (known as job or jobbing shops). The remaining 8300 (45 %) are surface treatment shops within another installation typically also an SME. The majority of jobbing shops serve more than one industry (see those listed in Table 1.1). There is no installation typical of the whole range of activities, and even though there are strong similarities between sites engaged in the same activities, no two sites will be identical. [3, CETS, 2002, 104, UBA, 2003] For gathering economic statistics, electroplating, plating, polishing, anodising and colouring are classified under the Standard Industrial Classification (SIC) code 3471, but this includes establishments engaged in all types of metal finishing. Companies that both manufacture and finish (surface treat) products are classified according to the products they make. For data on sources of emissions, the industry is classed under general purpose manufacturing processes (for emissions, NOSE-P 105.01 [2, EC, 2000]). These groupings make the extraction of data for specific surface treatments or for the whole sector difficult as they cannot be differentiated readily from the other engineering activities.

Surface treatment is positioned between initial workpiece or substrate manufacture and final product assembly, completion and packaging. Treatment (both in jobbing shops and many in-house workshops) often has low priority in the production chain, although there are significant exceptions. Low priority can result in insufficient attention to correct and up to date specifications, insufficient attention given in product design to minimise and reduce consumptions, as well as a lack of investment.

Surface treatment is usually carried out after the primary metal or plastic has been formed into workpieces or shaped substrates, such as nuts, bolts, pressed or moulded components, sheets, or coils. They may even be sub-assemblies made of several components, often of different materials. These components and sub-assemblies can be complex shapes which have been pressed, cast and/or machined. However, in coil processing the surface treatment is applied before the substrate used. The size varies from wires to steel strip 2008 mm wide. In smaller scale reel-to-reel applications, copper, brass or other alloys are also coated. Printed circuit boards are made from plastic or glass fibre boards which are already laminated (usually with copper) or plastic films.

Process lines are usually modular, and small lines can be easily assembled as a series of tanks. However, large automated lines and the modules in those installations handling steel coil on a large scale, or large components such as parts of aircraft wings, are typically specialist, large and capital intensive.

Most installations, particularly the jobbing shops, will operate multiple lines side by side. This assists in increased capacity and reliability of delivery, and allows the installation to offer different treatments (jig, coil or small scale coil, see Chapter 2) for different products and prices and/or to offer different finishes. In these cases, point 2 of Annex 1 to the IPPC Directive applies: *“Where one operator carries out several activities falling under the same subheading in the same installation or on the same site, the capacities of such activities are added together”* [1, EC, 1996].

As an example of geographic distribution and structure of the industry, in France the industry is widely spread, with concentrations in the south east (21 %) and the Paris area (24 %). The number of surface treatment installations where the volume of treatment vats exceed 1.5 m³ is 2250 (the threshold level for French national legislation), and the number where the volume of treatment vats exceed 10 m³ is 1260 [121, France, 2003].

1.2.2 Equipment lifetime

The vast majority of process lines are modular and the actual plant life is difficult to quantify as individual modules are repaired or replaced as necessary. Typically, complete production lines are only replaced at long intervals (when maintenance of individual modules is no longer sufficient), or when radically new technology is introduced. However, for large scale surface treatment operations such as steel coil coating and treating automotive bodies and panels, capital investment can be many millions of euros (and up to EUR 500 million for a complete paint shop installation) with a lifetime of 20 to 40 years. Depreciation is usually over 20 years [111, ACEA, 2003].

1.2.3 Technical characteristics of installations

Due to the modular nature of the process lines, some techniques can be installed or changed relatively quickly and cheaply. For instance, some process solutions are changed on a regular basis, others are expensive with a long life and change is an investment decision. Some techniques may require alterations or extensions to production lines. Although the modular nature facilitates such changes, in many cases other factors will affect the ease of change, such as the limits of transporter mechanisms and control systems, and the space available in the installation. In-house operations tend to be for specific products. Introducing changes for these and for plants handling larger products such as steel coil coating, aerospace parts or automotive bodies may be technically more difficult and/or involve higher capital costs. For larger plants, depreciation is usually between 6 and 20 years [157, ACEA, 2004].

Because of overcapacity in the sector, it is rare for totally new plants to be built. In existing installations, it is more common to replace modules or lines.

1.2.4 Market structure

1.2.4.1 Competition

The low cost and ease of modular construction of lines is a low barrier to entry. Businesses treating the surfaces of metals and plastics using only one or two process lines, often of small vat volumes, are frequently in direct competition for some customers with installations operating larger process lines utilising more abatement techniques.

While this industry serves several major manufacturing areas, there is a high concentration of customers in some areas (such as the automotive industry) with highly competitive markets, and surface treatment overcapacity. Very few jobbing shops are large enough to serve more than three or four industry types or provide more than three finish options, with most company business strategies focused on specialising in certain finish types. There are some limited opportunities to differentiate the business by providing specialist treatment finishes and/or by specialist quality standards, or for vertical integration such as manufacturing the components to be treated. The in-house installation is the complete vertical integration of the business. The large scale production lines depend on large volumes of very specific surface finishes, such as one type of coating for steel coil, and typically opportunities for diversification or new markets are extremely limited.

1.2.4.2 Extent of the market

The geographic size of the market is often proportional to the degree of specialisation of the treatment. Those treatments that are widely carried out by jobbing shops (such as zinc plating with chromium passivation) are carried out on a very local basis, with customers usually controlling the price. Other, more specialised, finishes where the higher price justifies transport costs (such as cadmium plating or anodising of large components to aerospace specifications) may be carried out on a national scale, or even between neighbouring countries. However, the concentration of surface treatment installations within Europe usually means physically extending markets brings more competitors within range.

The extent of the market for the customers' goods is also an important factor. During 2001 and 2002 the volume of business in the light engineering industries fell by 30 % across Europe. This was due to the increased exporting of the total manufacture of engineered components and assemblies to Asia (Verbal discussions, TWG).

Current predictions for printed circuit board (PCB) production are that by 2005/6 the worldwide PCB production may again reach the level of the boom year 2000. Due to the cost structure of Asian competitors, the long-term competitiveness of high volume PCB production in Europe using standard technologies remains questionable with global customers. Worldwide overcapacity may result in further mergers and insolvencies, unless further growth is generated in Europe. [122, UBA, 2003]

The percentage growth of multilayer boards (MLBs) and other high-tech products, including the disproportionate growth of HDI (high density interconnect) or microvia boards, demonstrates the technological development of European PCB production. It is expected that European PCB manufacturers will continue to move to high-tech areas, concentrating in segments such as sensor technology, industrial applications, telecommunications, automotive electronics, and medical and aeronautical industries (see Section 1.3.5).

1.2.4.3 Market substitutes

Substitutes in this context [88, EIPPCB,] means alternative, competing ways for the customer to achieve the desired result, and not the substitution for chemicals or other processes described in Section 4.9. Alternatives are readily available for many of the surface treatments of metals and plastics. The customer may change to one of these alternatives because of price or for design reasons. This type of substitution can take three forms:

- a different surface treatment system. For example, electrolytic or chemical treatments compete with surface treatments by solvent-painting: painted car door handles have largely replaced chrome-plated ones; lithographic printing from aluminium plates can be replaced by laser or ink jet for small runs
- component manufacture from a different material. The customer may redesign the products or components from alternative materials, reducing the need for surface treatment. For example, paint or foodstuffs can be sold in plastic containers instead of metal cans; lithographic plates can be produced with different substrates such as plastics
- a combination of the above. Car light reflectors can now be moulded from plastic with vapour deposition of a metal, instead of copper/nickel/chrome plating of a steel pressing.

Figure 1.1 and Figure 1.2 both show example activities where customers can switch between anodising and other coatings, according to design trends, customer specification requirements and cost.

1.2.5 Summary of general economic situation

Opportunities to pass increased costs to customers are limited because of:

- the large number of surface treatment installations competing for a decreasing number of customers
- the decline of engineering businesses in Europe
- the increasing substitution options (as described above).

1.3 Specific industry activities

1.3.1 Anodising of aluminium architectural panels and profiles

The surface treatment of aluminium predominantly for construction use as architectural profiles is carried out in more than 460 plants across the EU-15 and 6 non-EU-15 countries. Again, these are mainly small or medium enterprises [9, ESTAL, 2002]. In Europe, the consumption of anodised aluminium amounts to approximately one square metre per capita per year [118, ESTAL, 2003].

Figure 1.1 shows the total production for both anodising and other coatings for aluminium profiles in Europe.

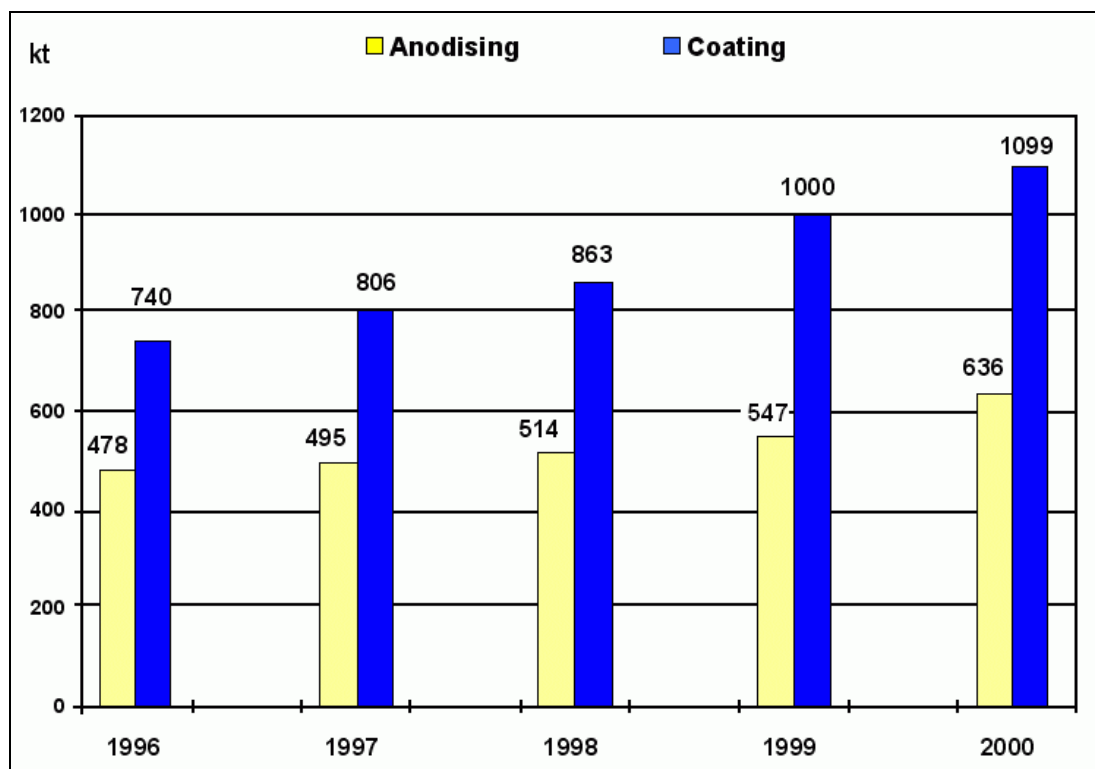

Figure 1.1: Total production of coatings for aluminium [9, ESTAL, 2002]

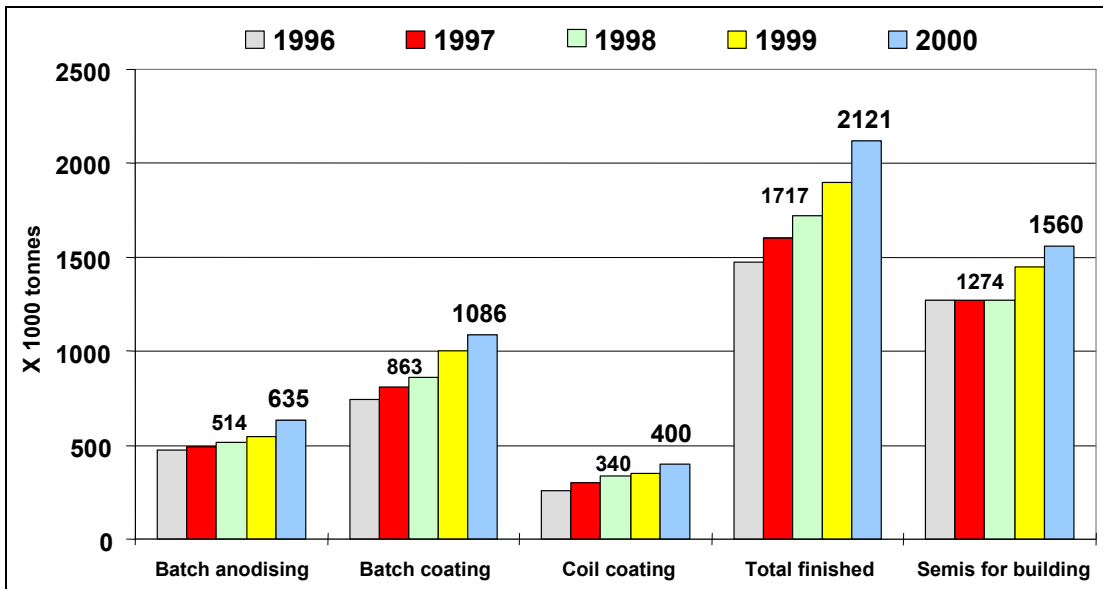

Figure 1.2: Total European aluminium surface finishing of architectural profiles [9, ESTAL, 2002]

Figure 1.2 shows the European production of anodising by batch (jig line, see Chapter 2), other coatings by batch, and other coatings on coils from 1996 to 2000.

Figure 1.3 shows the production of the leading four European countries for anodising of profiles from 1996 to 2000.

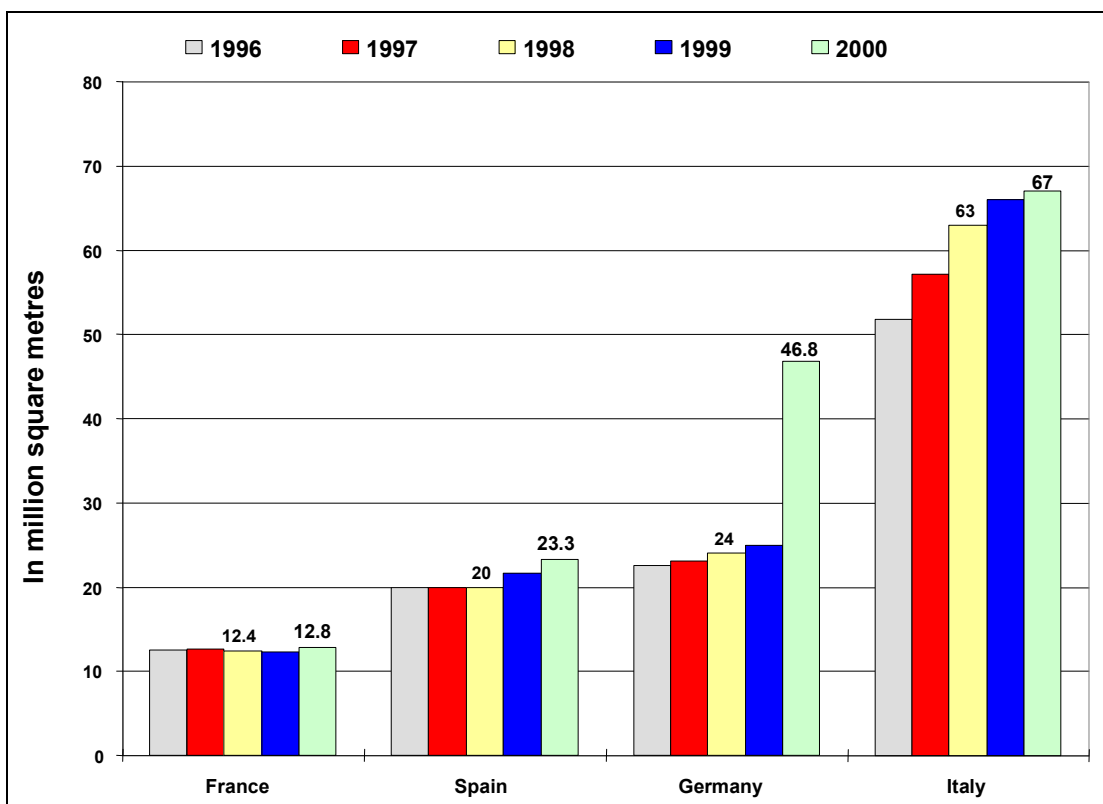

Figure 1.3: Leading anodising countries in Europe [9, ESTAL, 2002]

1.3.2 Large scale continuous coating of steel

There are four types of electrolytic treatment systems applied to steel coil in the EU-15: tin plate, chromium (ECCS: electrolytic chrome coated steel), zinc or zinc-nickel alloy and lead [19, Eurofer, 2003]. In the Czech Republic, copper, brass, nickel, and zinc are applied to steel strip in widths of 145 – 265 mm. [116, Czech-Republic, 2003] No data are known for other European countries.

Electrolytic tin plate and electrolytic chromium coated steel (ECCS)

The main application for the substrate from this process is packaging. The production of continuous electrolytic tin plate and electrolytic chromium (ECCS) in EU-15 was 4800 kt in 2000. The trend in production for both tin plate and ECCS is shown in Figure 1.4 and by country in Table 1.2.

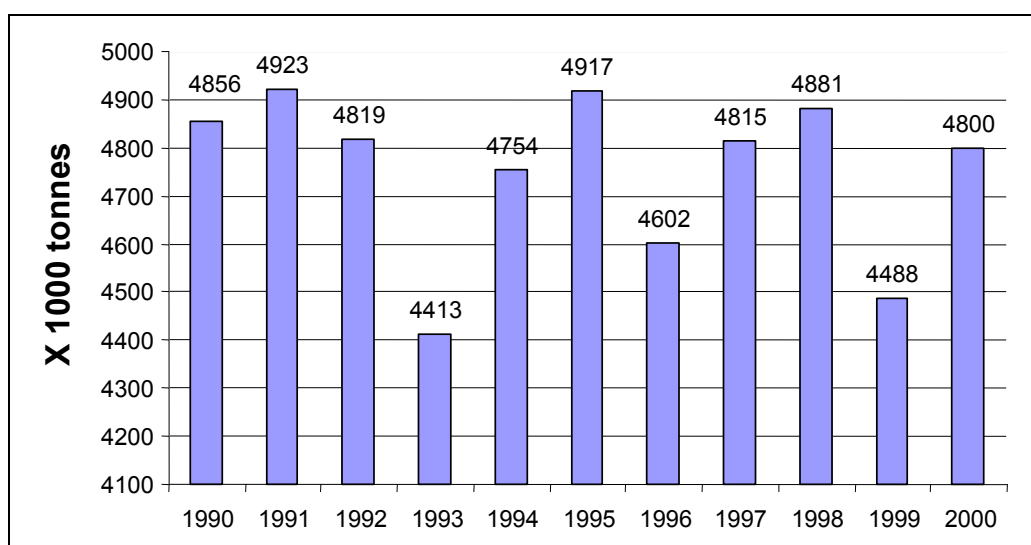

Figure 1.4: Steel for packaging (tin plate and ECCS) production in EU-15 (in kt) APEAL [19, Eurofer, 2003]¹

Country	Production (kt) tin plate in 2000 nd = no data	Production (kt) ECCS in 2000 nd = no data
Austria	nd	nd
Belgium	281	12
Denmark	nd	nd
Finland	nd	nd
France	886	207
Germany	802	147
Greece	69	nd
Ireland	nd	nd
Italy	283	67
Luxembourg	nd	nd
Netherlands	612	51
Portugal	76	nd
Spain	494	61
Sweden	nd	nd
United Kingdom	588	147
Totals for data given	4091	692

Table 1.2: Production tonnages for the year 2000 for both tin plate and ECCS by country in EU-15

¹ APEAL: - The Association of European Producers of Steel for Packaging – a federation of four multinational producers of steel packaging for Europe across seven countries. This represents some 90 % of the total European production of steel for packing and hence of tin plate and ECCS lines.

EUROFER STATS [19, Eurofer, 2003]

Tin plate and ECCS activities annual turnover is in the order of EUR 3000 million and employs directly and indirectly 15000 people.

There are installations in nine Member States. The number of continuous coil production lines in EU Member States operating, under construction and planned is shown in Table 1.3.

Country	No of tin plate lines nd = no data	No of ECCS lines nd = no data
Austria	nd	nd
Belgium	1	1*
Denmark	nd	nd
Finland	nd	nd-
France	5	5*
Germany	3	1
Greece	1	
Ireland	nd	nd
Italy	nd	nd
Luxembourg	nd	nd
Netherlands	4	2 including tinning*
Portugal	1	0
Spain	4	1*
Sweden	nd	nd
United Kingdom	2	1

* Indicates lines that can produce tin plate ECCS [119, Eurofer, 2003].

Table 1.3: Number of continuous lines producing both tin plate and ECCS in EU-15 [19, Eurofer, 2003]

Figure 1.5 shows the share of tin plate and ECCS consumption by industries in the EU-15 with an average annual production close to five million tonnes. Steel packaging of human and pet food represent the main application with a 48 % share, followed by general production lines (for paint cans, industrial cans, etc.).

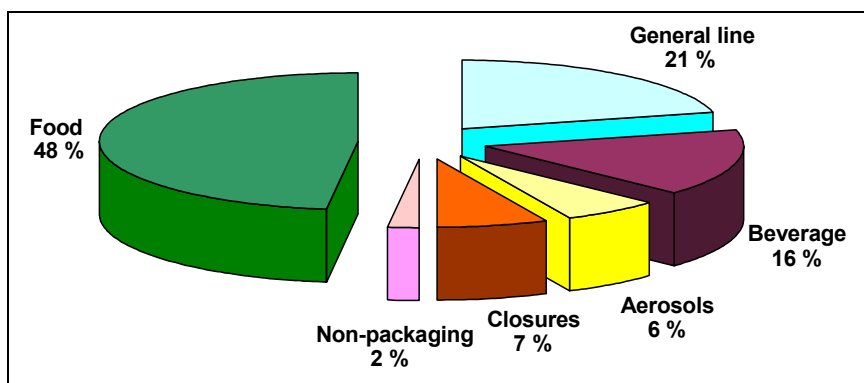

Figure 1.5: Main consuming industries for tin plate and ECCS outputs APEAL [19, Eurofer, 2003]

Continuous electrolytic zinc and zinc nickel (Zn and Zn-Ni) coating of steel

Since the 1970s, the production of zinc and zinc alloy-coated steel sheet has increased significantly. This has been largely for the automotive industry in response to the demand for anti-corrosion guarantees and longer vehicle lifetimes.

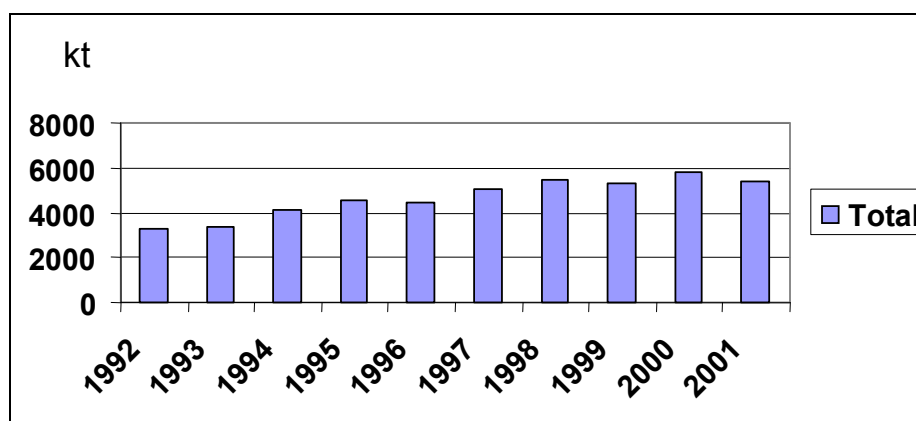

Figure 1.6: Production of continuous electrolytic zinc/zinc-nickel in EU-15 (in kt)
[19, Eurofer, 2003]

The production of continuous electrolytic Zn or Zn-Ni coating steel was 5.37 Mt in 2001. The evolution of the production in the EU-15 is shown in Figure 1.7, below.

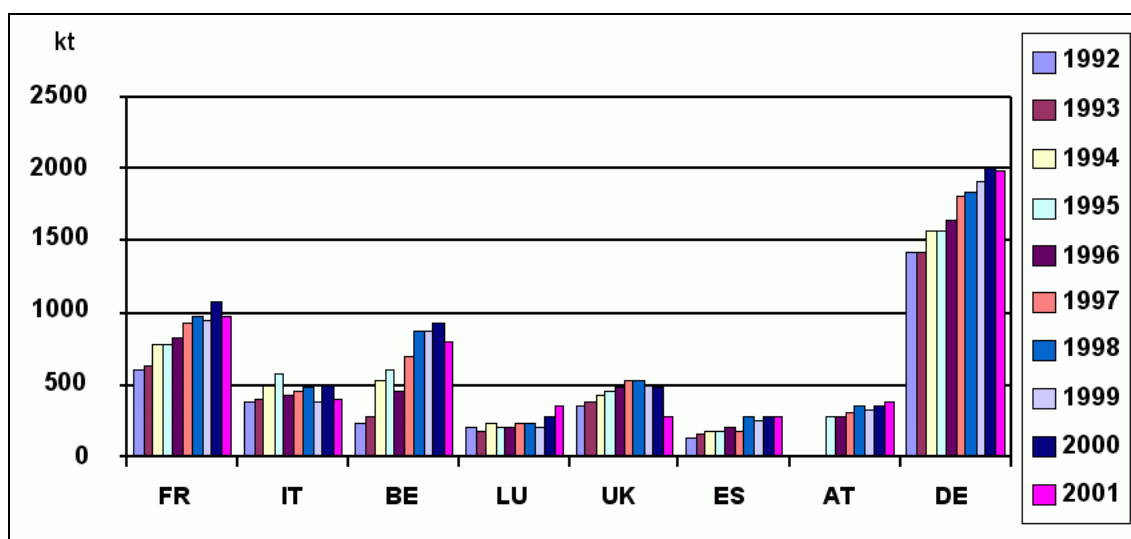

Figure 1.7: Production of continuous zinc and zinc-nickel coating steel in EU-15 (in kt)
[19, Eurofer, 2003]

Continuous electrolytic lead coating of steel

There is only one continuous lead coating plant in Europe (Austria). This plant will lose key European automotive customers and is due to close by 2005 – 6. This is due to European legislation controlling the amount of lead in end-of-life vehicles [99, EC, 2000].

Other continuous electrolytic coating of steel

In the Czech Republic, there is an installation for the continual application of metallic coatings (copper, brass, nickel, zinc) on steel strip (width 145 – 265 mm) with a total capacity 8000 t/yr steel. [116, Czech-Republic, 2003]

1.3.3 Coil and sheet anodising for lithographic (offset) printing plates

Lithographic or offset printing uses an intermediate roller to transfer ink from a plate to paper. It requires plate-making that is simple, quick, and economical. Aluminium is the usual substrate of choice. There are two types of plates: [38, Ullmann, 2002/3]

- pre-sensitised (PS) plates (manufactured with a photosensitised finish). Current world sales are about $180 \times 10^6 \text{ m}^2$
- wipe-on plates which are not pre-coated and are coated by the printer as required. They are still being used in some countries, mainly the United States and Eastern Europe. Worldwide consumption amounts to about $30 \times 10^6 \text{ m}^2$.

1.3.4 Continuous coil processing of aluminium

Many hundreds of kilotonnes per year of aluminium coil are processed through lines of the main rolling mills and other companies. Processes include cleaning, pretreatment, etching, anodising, colouring, sealing, electrobrightening and tunnel etching [118, ESTAL, 2003].

1.3.5 Printed circuit boards

The world market for PCBs in 2002 was USD 31640 million, down 24.3 % from the market peak in 2000 of USD 41824 million, which was a boom year for electronics (see Figure 1.8) [122, UBA, 2003].

The European share of the world market in 2002 was 18.0 %. The shares of the other regions were: Africa and the Middle East: 1.3 %, South East Asia: 26.4 %, Japan: 25.1 % and the Americas 29.2 %.

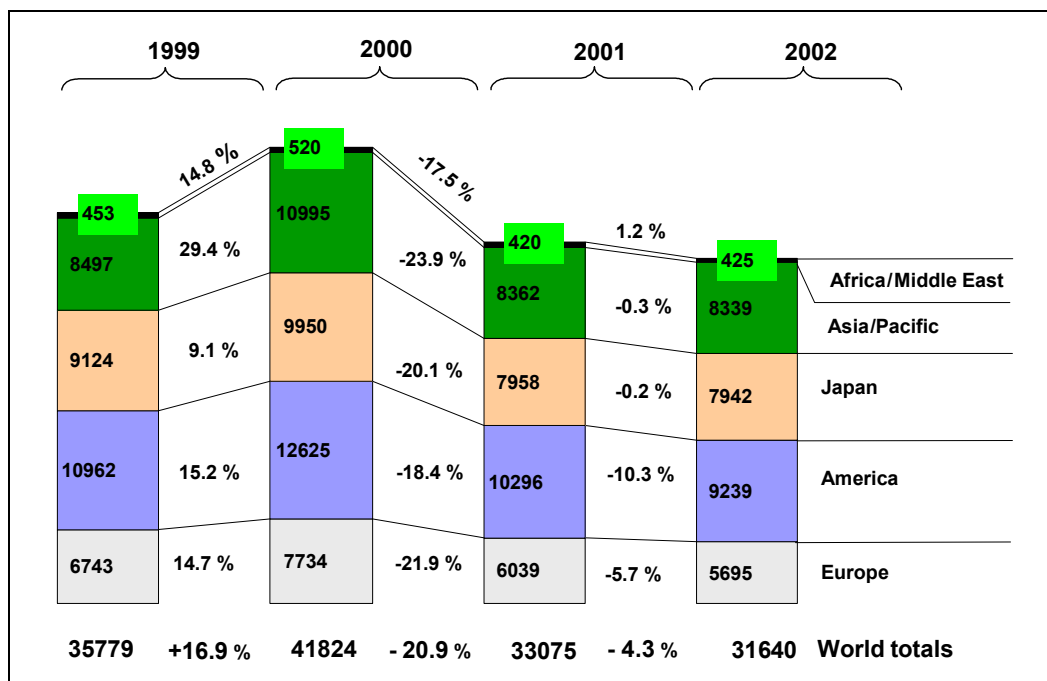

Figure 1.8: World market for PCBs 1999 – 2002 per regions, value in million USD [122, UBA, 2003]

Production of PCBs in Europe

In 2002, the total PCB production in Europe was EUR 3422 million, and employed 29000 people at 434 plants.

The number of European manufacturers has changed significantly. In 1999, there were 612 manufacturers, which reduced to 434 by 2002. More than 80 % of these have a turnover of less than EUR 7.5 million/yr showing the European industry is dominated by SMEs, despite the high level of technology (see Figure 1.9).

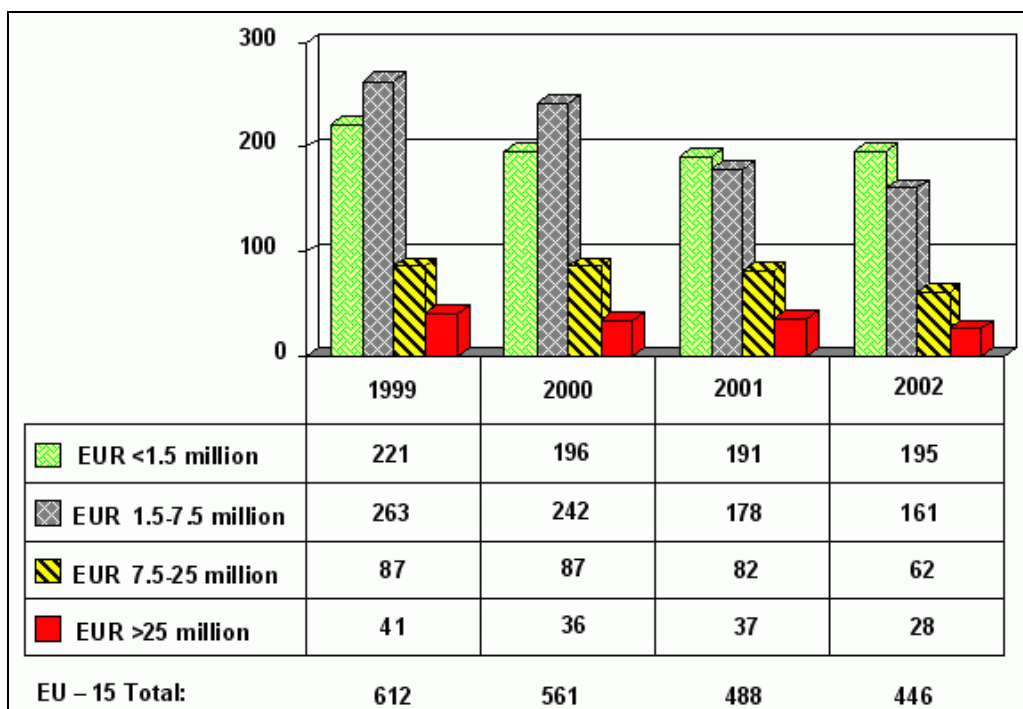

Figure 1.9: Number of PCB manufacturers in Europe by turnover
[122, UBA, 2003]

Figure 1.10 shows the industrial sectors served in 2002.

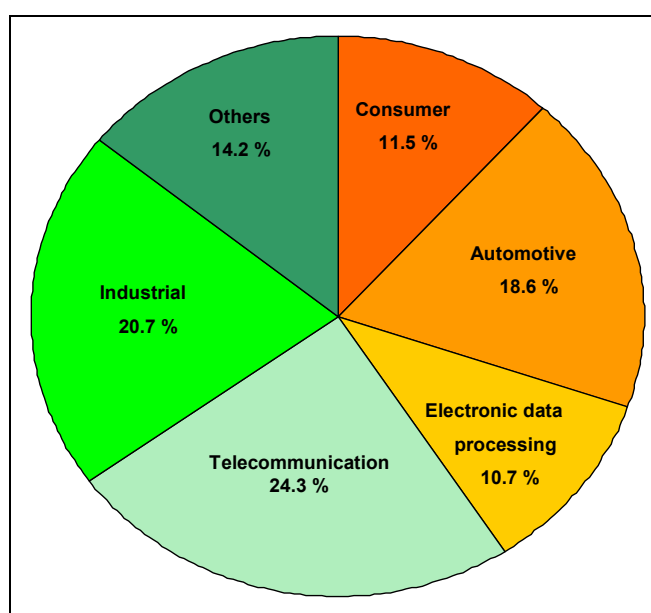

Figure 1.10: Industry sectors served by European PCB production in 2002
[122, UBA, 2003]

In Europe, the percentage of high-tech PCB production has grown as a proportion of the total, showing the technological strength of the European PCB industry. This underlines the trend to higher specification products, with ever-more detailed structures in the smallest possible dimensions (see Section 1.2.4.2).

1.4 Key environmental issues

1.4.1 Overall

The STM industry plays a major role in extending the life of metals, such as in automotive bodies and construction materials. It is also used in equipment that increases safety or reduces consumption of other raw materials (e.g. plating of aerospace and automotive braking and suspension systems, plating precision fuel injectors for automotive engines to reduce fuel consumption, etc.). The main environmental issues arising from the surface treatment of metals and plastics relate to energy and water consumption, the consumption of raw materials, emissions to surface and groundwater, solid and liquid wastes and the site condition on cessation of activities.

Surface treatments have traditionally been associated with large water usage creating a wet working environment, although many installations have moved away from this way of working. The chemicals used have the potential to cause environmental harm particularly to surface waters, groundwaters and soil. Metals removed from waste waters end up in solid wastes and, together with some used process solutions, may need special management for recovery or disposal. The industry can discharge fumes and dust to air, as well as generating noise. The sector is a significant user of electricity, water and non-renewable resources (metals). The following issues are crucial:

- minimisation of the consumption of raw materials, energy and water
- minimisations of emissions by process management and pollution control
- minimisation of waste production and its management
- improvement of chemical safety and reduction of environmental accidents.

The measures to achieve better environmental performance are frequently complex and have to be assessed in respect to their potential impacts on the product and other processes (both pre- and post-treatment), the age and type of installation as well as the benefits to the environment as a whole. Best available techniques will be balanced against these criteria and therefore include changes within process units as well as end-of-pipe abatement techniques.

Sophisticated process and treatment techniques play an important part in achieving improved environmental performance. Competent operation and regular maintenance are as essential as the choice of technology. Important considerations therefore include good management and working practices, good process and site design, education of the workforce on environmental and process performance, workplace safety and accident prevention, and finally, monitoring of the process and environmental performance.

1.4.2 Water

The activities covered in the scope of this document predominantly use aqueous solutions as the medium, therefore the management of water, its pathways and targets – the protection of surface water, groundwater and soils – are central themes. Both in-process techniques and end-of-pipe processes can affect the type and quantity of solid and liquid wastes produced (sometimes negatively), as well as changing the quality of waste waters.

Process waters are often treated in on-site waste water treatment plants. The discharge is then usually to municipal (urban) waste water (sewage) treatment plants, or if the effluent is treated to a suitable standard, directly to surface waters. This is the principal route for chronic pollution and can be caused by poor process controls and/or inadequate end-of-pipe controls. This may be due to poor management and maintenance, or lack of investment.

Although the industry has improved both its practice and infrastructure in many areas, it is still the source of a significant number of environmental accidents [44, France, 2003]. For France, from 1992 to 2002, 1.2 % of all serious industrial water pollution incidents were attributable to this sector, rising to 5 % for 'near misses' [121, France, 2003]. Thames Water plc in the UK has identified the sector as posing a high risk to sewage and water resource operations [Tempany, 2002 #18]. The impacts can include the loss of biological sewage treatment processes, disruption of sewage sludge management, as well as damaging water resources for drinking water use and aquatic ecosystems.

Poor housekeeping or accidents in handling and storing solutions, including the failure of storage containers and process tanks, cause acute polluting discharges to surface waters, as well as both chronic and acute pollution events affecting groundwaters and soils. The batch discharge of used process solutions without adequate treatment [113, Austria, 2003], or which overload treatment facilities, is also a cause of surface water pollution. Overload may be caused by poorly designed or out-of-date facilities, production capacity increasing beyond the projected design capacity, changes in process type and/or poor control of water and material usage in the processes [158, Portugal, 2004].

Water usage is also an important issue. The largest proportion of water intake is used in rinsing between process stages and then discharged. In some sites, significant amounts of water are used in cooling. There may be insignificant amounts of water in wastes and there are some losses in evaporation from drying components, hot solutions in open tanks and from some recovery processes. Some water is used in making fresh process solutions (make up); the service life of these solutions varies according to the activity and throughput.

1.4.3 Energy

Electricity is consumed in electrolytic and other electrochemical reactions (*inter alia*, electroplating and anodic oxidation). Electricity is also used to operate the process plant and equipment such as pumps, transporter equipment, other motors and compressors. It may also be used for supplementary vat heating (by immersion heaters) as well as space heating and lighting in the installation.

There are transmission losses when electricity is transformed from high to low voltages [111, ACEA, 2003]. Energy can also be lost when drawing from more than one phase (reactive energy), as well as in DC (direct current) supplies to the treatment lines. Energy is lost, too, as heat when electric current is passed through the treatment solutions: some process chemistries are less energy efficient than others.

Energy is also consumed in raising the temperature of the process baths, in drying components and for other heating activities. Losses occur from evaporation and as radiant heat from equipment. Some process chemistries require more heat energy than others. Energy is also used in drying workpieces or substrate and in extracting process fumes. [158, Portugal, 2004]

Cooling can consume significant amounts of water in open flow or some cooling towers, and electricity is consumed by sealed refrigerating systems.

1.4.4 Substances of concern

Due the wide range of process activities, the range of substances used and emitted by the industry is substantial. However, most installations will only use or generate some (and not all) of these substances [111, ACEA, 2003]. Table 1.4 identifies key substances used and the media they may affect when emitted. As most substances are used in aqueous solutions, they will be found in process waste waters as well as in-plant leakages and spills. Very little is known of the breakdown products in the processes.

Principal substances of concern	Medium affected			
	Water	Soil	Air	Other issues to be considered
Note: It is unlikely that all substances will be used or arise in one installation, as they are process-dependent				
Metals:				See Annex 8.1
Zinc	√	√		
Copper	√	√		
Nickel	√	√		Health issues during use and in products
Chromium	√	√	√	Health issues with aerosols of Cr(VI) solutions
Lead	√	√		Pb and Cd are EU priority pollutants
Cadmium	√	√	√	
Non-metals:				
Cyanides	√	√	√	Toxic
Hypochlorite	√		√	Concern for formation of AOX with other substances. Can release chlorine under certain conditions
AOX (absorbable organic halogens)	√	√		May be formed in some effluent treatments
Peroxides				Oxidising agent: storage issues
Surfactants:				
Dispersing agents, emulsifiers, detergents, wetting agents (including nonyl and other alkyl phenyl ethoxylates (NP/NPEs) brightening agents (brighteners), PFOS	√			NPE is banned. Health and environment issues with PFOS, see Annex 8.2
Complexing agents:				
EDTA	√			
Tartrate, EDDS, NTA, gluconate, Quadrole	√			
Sodium dithionite	√			Storage issues
Acids and alkalis:				
Hydrochloric, nitric, phosphoric, sulphuric, hydrofluoric, acetic	√	√	√	Acid fumes, particularly NO _x
Sodium and potassium hydroxides, lime	√	√	√	Dusts
Other ions	√	√		Local environmental issues
Solvents:				
Trichloroethylene (TRI)	√	√	√	Other legislation applies to air emissions
Tetrachloroethylene (PER)	√	√	√	
Trichlorotrifluoroethane (CFC-113)	√	√	√	
Methylene chloride	√	√	√	
Gases:				
Chlorine			√	Used in cyanide treatment
Dusts		√	√	From finishing and polishing
Wastes	√	√	√	

Table 1.4: Key substances of concern across the sector and media potentially affected

Process discharge problems with metals, cyanides, surfactants, complexing agents, acids, alkalis and their salts can be addressed by substituting processes and/or chemicals, and managing processes and rinsing systems to reduce the amount of chemicals dragged out of the solution on the substrates being treated. End-of-pipe treatment may also be applied.

1.4.4.1 Metals

The main impact of metals is as soluble salts. Metals are conservative materials, that is, they cannot be created or destroyed: they are neither created nor destroyed in the treatment processes or in waste water treatment. Their form may be changed and/or managed so they cannot readily access environmental pathways but their disposal means that the metals still remain in part of the environment. Options exist for maximising their in-process recovery and recycling as well as for external recovery. They can also be separated in end-of-pipe systems into sludge. Metals not removed from the effluent accumulate in sewage sludge or in aquatic ecosystems. Management routes for municipal waste water treatment sludges vary in all Member States and are strongly dependent on the acceptability of applying the sludges to agricultural land where the metal content is a key determining factor.

While all the metals used in surface treatment (including substrates) can have adverse effects, depending on their speciation, six metals are of most concern for their environmental and/or health effects: cadmium, lead, nickel, chromium, copper and zinc [114, Belgium, 2003]. A Commission Decision [2, EC, 2000] implementing an inventory of emissions and sources from IPPC installations requires the reporting of the quantities emitted above certain thresholds and the six metals are mentioned in key EU environmental directives, PARCOM (now OPSAR) [12, PARCOM, 1992] and four are restricted in product-related directives (see Annex 8.1).

Cadmium's toxic properties are well established and it is a priority hazardous substance according to the Water Framework Directive [93, EC, 2000]. However, it has certain key properties important in surface treatment (see Section 2.5.5), for applications with high fail-safe requirements such as aeronautical and aerospace, nuclear, mining, and communications applications. Its use is therefore restricted to these by the Marketing and Use Directive as amended [144, EC, 1976]. These controls have been in place for many years and emissions of cadmium have been considerably reduced from the surface treatment industry.

Hexavalent chromium has adverse health effects, causing skin and mucus membrane irritation and certain cancers. Aerosols are generated from the electroplating process solution by cathodic hydrogen evolution (see Section 2.5.3). Workplace health and safety regulations usually require measures to meet maximum allowable concentrations (MACs). Hexavalent chromium is also soluble at a wide range of pHs contributing to high aquatic toxicity. Due to its solubility and chemistry, it must first be reduced to trivalent chromium before precipitation in waste water treatment plants. Recent Directives [99, EC, 2000, EC, 2003 #98] limit the quantities of hexavalent chromium (but not the metal) in certain products treated by this industry.

Nickel metal and its salts have adverse health effects: nickel sulphate is currently classed as a category 3 carcinogen² [105, EC, 1967]. Aerosols and airborne particles can arise from electroplating and autocatalytic (electrocatalytic) as well as plant and solution maintenance operations. Again, workplace health and safety regulations usually require measures to meet maximum allowable concentrations (MACs). Nickel and its salts can cause allergic contact dermatitis and contact can be avoided by using good health and safety at work practices [144, EC, 1976, CETS, 2003 #115].

Lead is subject to a review for possible identification as a priority hazardous substance. Recent Directives [99, EC, 2000, EC, 2003 #98] also limit the quantities of lead in certain products treated by this industry.

² R40: possible risk of irreversible effects. R42/43; may cause sensitisation by inhalation and skin contact.

1.4.4.2 Cyanides

Cyanides are well-known hazardous substances but are still essential in some processes. As well as their inherent toxicity, cyanides give off cyanide gas in acid conditions. Cyanides can cause problems in effluent treatment by strongly complexing some metals, such as nickel, and this interferes with both the easy oxidation of the cyanide and the separation by precipitation of the metal (see complexing agents, Section 1.4.4.5). There is a PARCOM recommendation for cyanide to be substituted [12, PARCOM, 1992].

1.4.4.3 Hypochlorite, chlorine and AOX

Hypochlorite and chlorine are used in the oxidation of cyanide in waste water treatment plants. They are capable of reacting with organic substances to form AOX (absorbable organic halogens). [104, UBA, 2003] Hypochlorite has been flagged by OSPAR as a candidate substance for prioritisation for cessation of emission [131, OSPAR, 2002 ongoing]. Chlorine is the only gas likely to be used in surface treatment installations for the oxidation of cyanide, and is not widely used. Hypochlorite can release chlorine in certain conditions, such as low pH.

1.4.4.4 Surfactants

Surfactants are widely used in many of the processes, such as in degreasing, in wetting surfaces and assisting other processes such as etching, and as brighteners by promoting finely divided metal deposition. Some surfactants have low degradability in aquatic systems, and the by-products of degradation may have adverse effects. Nonyl phenyl ethoxylate (NPE) is cited as being used in the industry. [38, Ullmann, 2002/3] For metal working, with effect from 17 January 2005 [115, CETS, 2003], NPE and nonylphenol are OSPAR chemicals for priority action and are banned except for uses in “*controlled systems where the washing liquid is recycled or incinerated*” [30, EC, 2003]. PFOS (perfluorooctane sulphonate) is widely used as a foam suppressant and surfactant, especially in preventing the formation of mists in hexavalent chromium electroplating and alkali non-cyanide/zinc baths. However, it is now under investigation (see Annex 8.2, [109, DEFRA, 2004]) and the OECD Task Force on existing chemicals has already agreed that it is persistent, bio-accumulative and toxic.

1.4.4.5 Complexing agents

Complexing agents [73, BSTSA,] including cyanides and EDTA retain metals as complexes and preventing the absorption the metal onto sediments or suspended sediments. The soluble metals may be carried through effluent treatment systems and into sewage and aquatic systems. EDTA is both a strong complexing agent and has low biodegradability. Excess uncomplexed EDTA carried into aquatic systems may remobilise metals from sediments with high metals loads [22, Fraunhofer, 2002].

1.4.4.6 Acids and alkalis

Acids and alkalis are commonly used industrial chemicals and their discharge without neutralisation may affect sewers or receiving watercourses. Spillage and leakage can also contaminate soils. When used in hot solutions, the resulting fumes may cause problems in the workplace or locally when extracted. Hydrochloric acid is the most commonly used acid and its fumes can also cause corrosion damage inside the installation, affecting equipment controls. Specific problems occur with nitric acid, as it can release NO_x when in contact with metals. This is a local environmental and workplace health issue, as most installations are not significant NO_x emitters. Sulphuric acid is widely used, particularly in anodising. However, concentrations are lower than the level for the emission of fumes.

1.4.4.7 Other ions

Chlorides, sulphates, phosphates and other salts are the necessary anions in treatment solutions and are not usually a problem when discharged to municipal waste water treatment plants. However, they may occasionally cause salinity problems, and phosphates and nitrates [121, France, 2003] contribute to eutrophication, especially if discharged directly to surface waters.

1.4.4.8 Solvents

Solvents are used for degreasing incoming components. 1,1,1,-trichloroethane used to be widely used, but is being phased out under controls as an ozone layer damaging substance. The heavier solvents trichloroethylene and tetrachloroethylene can cause problems including accumulation into, and leakage from, sewerage systems [70, Ellis, 2001]. This can cause health and safety problems to maintenance workers and pollution problems to groundwater. Non-halogenated solvents are also used, but have lower environmental impacts. The Solvent Emissions Directive [97, EC, 1999] controls the use and emission of VOCs and the Reference Document on Surface Treatments using Solvents (the STS BREF) discusses BAT for solvent-based processes [90, EIPPCB,]. Organic solvents also have health and safety effects in use and the degree and type of control depends on the substance [113, Austria, 2003].

1.4.4.9 Dusts

Dusts are generated from finishing and polishing where these occur as directly related activities. They are usually a mixture of particles of abrasives with the abraded substrate. They may have health and safety impacts in the workplace, but can have adverse environmental impacts when extracted to the outside environment. The collected dusts require disposal as wastes, and may be hazardous.

1.4.4.10 Wastes

Much of the waste produced from process activities is likely to be classed as hazardous [92, EC, 1991, 100, EC, 2000]. The industry produces in the order of 300000 tonnes of hazardous waste a year in Europe³ (approximately 16 tonnes a year per installation). Liquid wastes are spent process solutions that cannot be treated or discharged, and solid wastes are largely sludges from waste water treatment plants and treatments of process solutions. Metals may be recovered from both solid and liquid wastes. Other solid wastes include broken equipment such as jigs (which may contain recoverable materials), packaging for workpieces as well as used chemicals (see Section 2.13.2).

1.4.5 Other emissions

1.4.5.1 Noise

Surface treatment is not a major noise emitting industry. However, some activities and associated activities do generate significant noise. These can be as peaks, such as unloading of metal components in stillages, or continuous noise from finishing and polishing or fans and motors sited externally.

³ This derived from an industry estimate of <1 % of hazardous waste in Europe and the Eurostat figures from hazardous waste management in the EU-15.

1.4.5.2 Odour

Again, odour is not a major factor for this industry. However, odour can be associated with some activities, particularly acid fumes and especially when stripping metal layers. The impact will depend on the type and size of activity carried out, the design and operation of any extraction system (e.g. chimney height) and the proximity of receptors, such as housing.

2 APPLIED PROCESSES AND TECHNIQUES

General description of activities

The surface treatments of plastics and metals described in this document are mostly water-based and the installations carry out activities sequentially, usually in process lines made up of a series of vats or activities. Figure 2.1 shows a simplified process workflow of a typical process line. All lines (except some simple iron phosphating lines, see Section 2.5.16) contain more than one treatment or activity type, usually with rinsing vats in between. Some activities are waterless, such as drying and, for printed circuit boards, drilling. The size of an individual vat can range from a few litres for precious metal coating, to 500 m³ or more for some installations processing aerospace workpieces. Historically, the surface treatment industry has been characterised by the large volumes of water used in processing, and these were often visible running across process area floors: this is no longer usual [124, Germany, 2003] [111, ACEA, 2003].

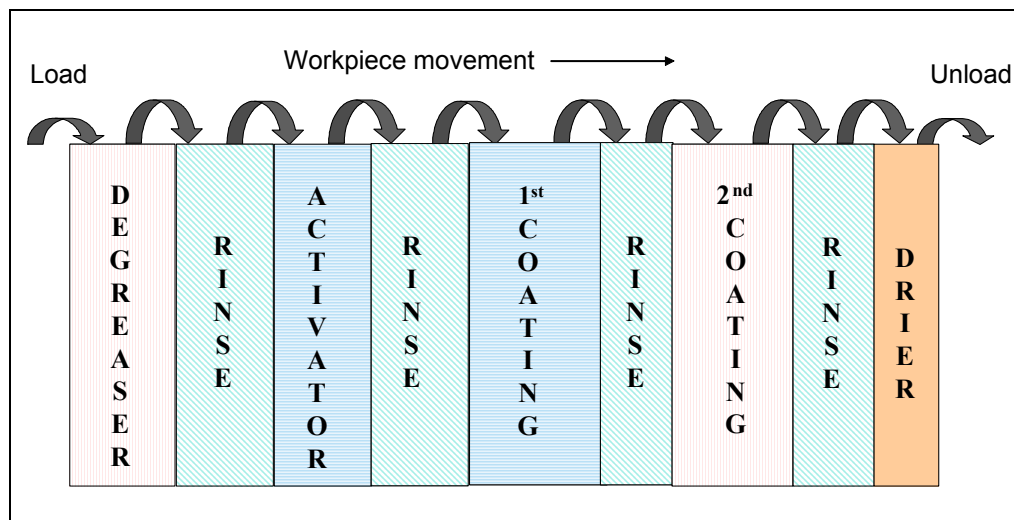

Figure 2.1: A simplified process line workflow diagram

A common feature of surface treatment installations is the large number and complex mix of processes and activities carried out in an installation, particularly in jobbing shops (as shown in Figure 2.2), as well as in single purpose installations (see Figure 2.27). Figure 2.7 shows a section through a typical jig plating process line with multiple processes and activities (note the activities are not carried out in numeric order because of transporter programming) and Figure 4.33 shows two large scale jig lines in an installation.

The size and complexity of the installation, the core activities and associated activities are dictated by:

- the type of surface treatments to be carried out
- the quality standards being worked to
- the type, size and amount of workpieces (substrates) to be treated
- the transport systems required to handle the workpieces.

These all also impact on the pollution potential from the installation.

Before and after the activities described here, subsequent operations may be performed on the workpiece or substrate such as pressing, forming, bending, crimping, drilling, welding, soldering, etc. These subsequent operations, as well as the final use of the treated product, will be critical factors in determining the specification and type of surface treatment to be applied.

The manufacture of printed circuit boards is the most complex, and can involve over 40 activities.

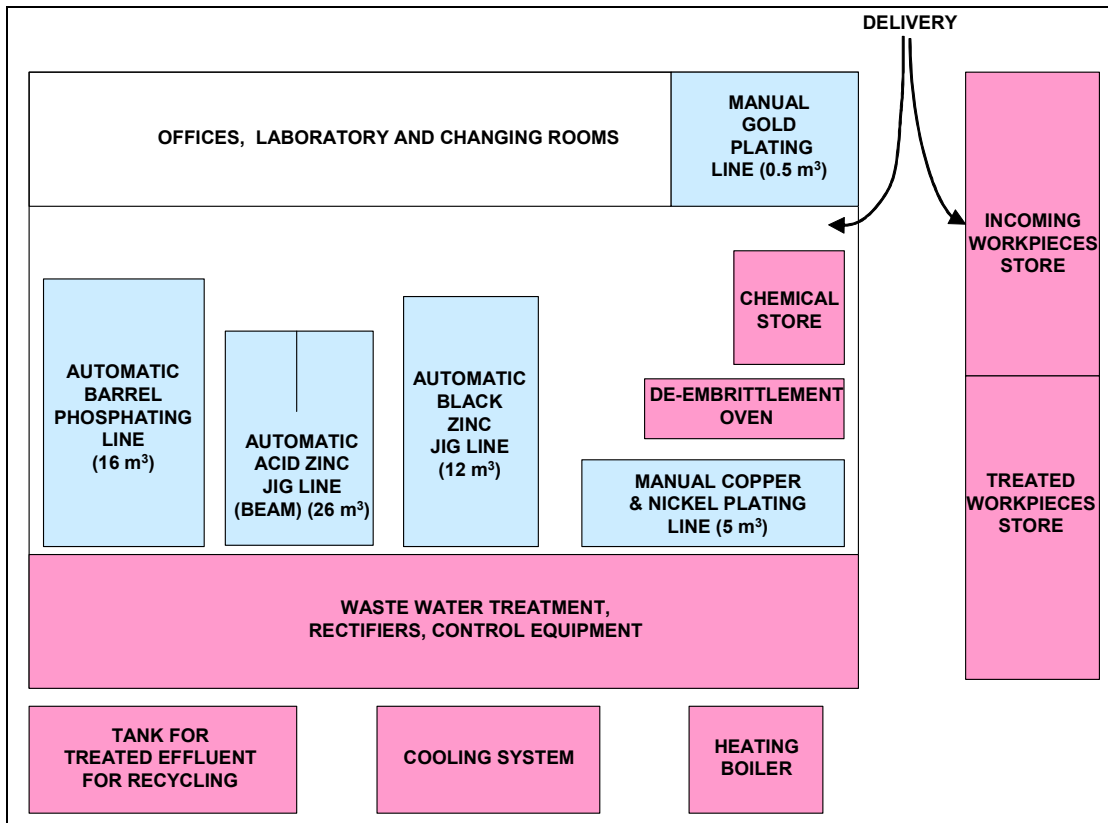

Figure 2.2: Example of a jobbing shop layout

Despite this complexity and the range of activities described in this chapter, all workpieces or substrates pass along a common route of activities, described in Figure 2.3. The first activity on-site is the delivery and storage (Section 2.1) of incoming workpieces, substrates and raw materials. Workpieces or components are loaded onto the appropriate transport systems (see Section 2.2) prior to pretreatment, such as degreasing. Most workpieces or substrates are given more than one pretreatment (see Section 2.3), and some of these may be prior to loading to a process line. The workpieces or substrates are then surface treated with one or more of the activities described in core processes. Rinsing, (see Section 2.4), is usually carried out between processes steps, whether they are pretreatment and/or core processing steps. Treatment is followed by after treatments such as drying, (see Section 2.6), and the workpieces or substrates are stored and dispatched (described in Section 2.1, together with incoming goods).

All the core treatment processes and other activities have historically been developed for jig lines. Indeed, jig lines still carry out the widest range of activities. **The treatments are therefore described generically for jig lines. Specific issues for barrel and coil processing and printed circuit boards are described subsequently:** barrel processing in Section 2.8, coil processing for large scale steel coils in Section 2.9, coil and sheet processing for aluminium lithographic plates in Section 2.10, and printed circuit boards in Section 2.11.

There are also utility inputs - energy and water - to surface treatment installations (described in Section 3.2), as well as the use of abatement techniques for the treatment of water, waste and air emissions (see Section 2.13).

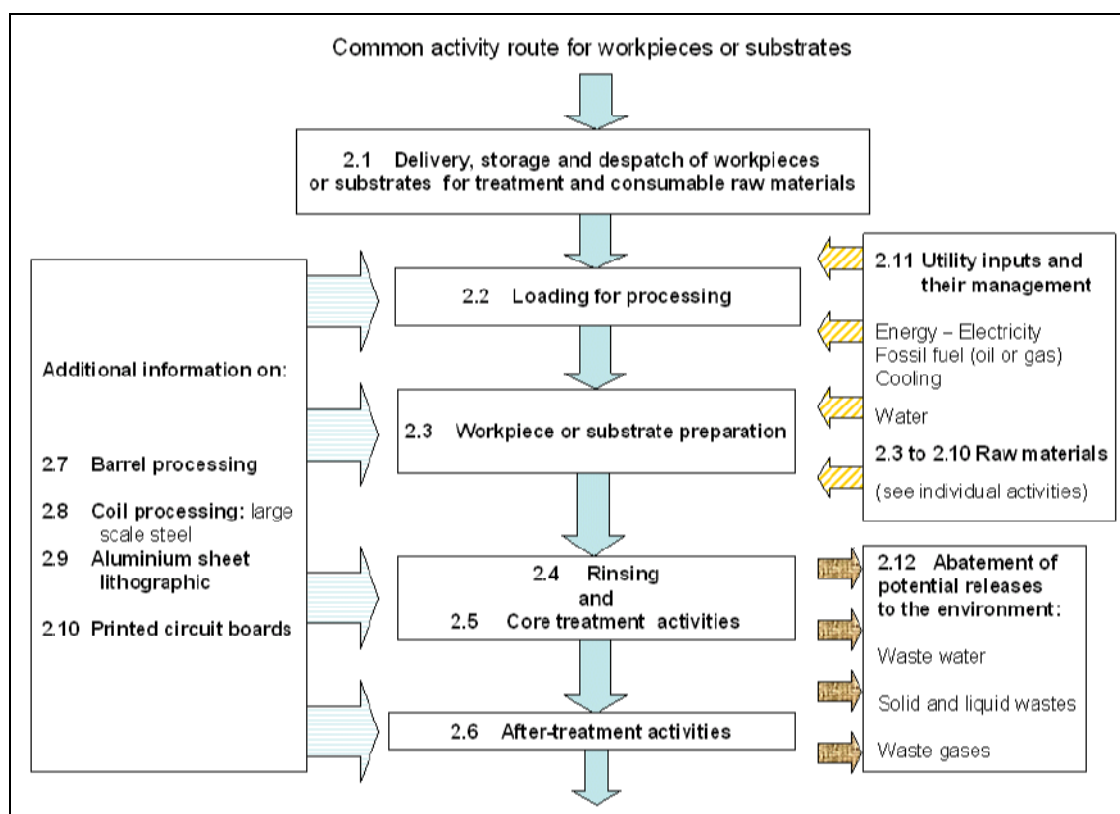

Figure 2.3: Common route in Chapter 2 for workpieces and substrates and the activity descriptions

Electrolytic processes

An electrolytic process needs:

- a solution of electrolytes, i.e. capable of carrying a current
- at least two electron conductors (electrodes) and the ability to form a circuit
- a current – usually direct current (DC), although the voltage can be AC or reversing DC in specific cases.

The electrolytic process requires the electrolyte to complete an electric circuit between the electrodes. When the electrodes are connected to a source of direct current (DC), one electrode, the cathode, becomes negatively (–ve) charged while the other, the anode, becomes positively (+ve) charged. The positive ions (cations) in the electrolyte will move towards the cathode and the negatively charged ions (anions) toward the anode. This migration of ions through the electrolyte constitutes the electric current in that part of the circuit. The migration of electrons into the anode, through the wiring and an electric power supply (supplied by rectifiers), and then back to the cathode constitutes the current in the external circuit. Electrolysis therefore converts electrical energy into chemical energy [11, Tempnany, 2002, 34, Brett, 2002, 35, Columbia, 2002, 36, IUPAC, 1997].

Chemical energy in electrolytic reactions is associated with changes in the oxidation state in part of the circuit (in the electrolyte, at the anodes or at the interface) and can be manifested as some or all of the following:

- the dissolution of metal ions into electrolyte
- the deposit of metal from the electrolyte
- some layer conversion coatings, e.g. anodising, change the oxidation state at the anode surface (see Section 2.5.13)
- the release of gases. In the circuits discussed here, hydrogen and/or oxygen are the gases usually released.

Electrolytic cells and reactions

When the workpiece or substrate is connected to the circuit in the electrodeposition cell, the cations (in the example, M^+ and H^+) move towards the cathode (-ve). The metal is deposited while hydrogen is generated as a secondary cathodic reaction. The anions (e.g. Cl^-) move towards the anode (+ve) [118, ESTAL, 2003, Ireland, 2003 #125].

As a simple example, M is the metal being electroplated, and X is the anion in solution:

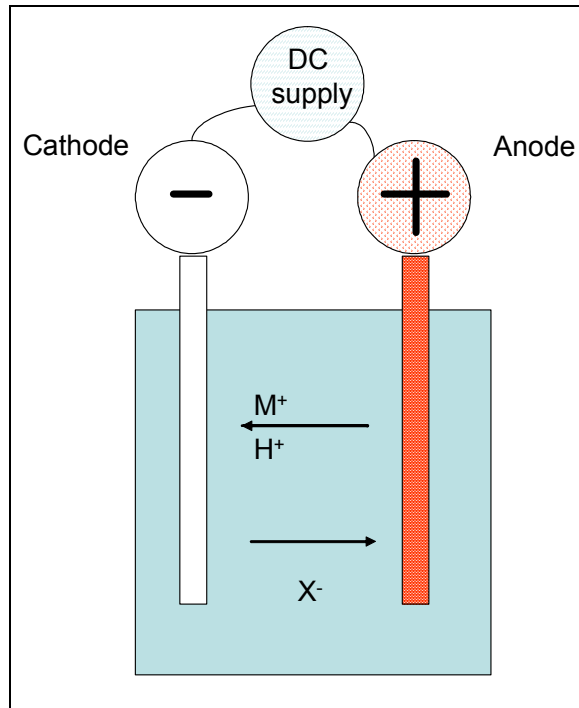

- in acid solution:

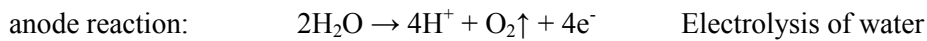

- in alkali solution:



The choice, design and sizing of the other line components and associated activities are dependent on the choice of the electrolytic cell and its components. The choice of an electrolytic cell depends on:

- the industrial applications the producer intends to supply
- the layer type and thickness required (deposit and/or conversion) and of the throughput capacity required
- the type of substrates (workpieces) to be treated
- the transport type required to move them: jig, barrel or coil.

Electrolytic cells may be classified in function by four main parameters:

- electrolytic cell geometry
- current density
- types of electrolyte bath (described for each process, below)
- anode types.

Two families of anodes are available:

- soluble anodes which have two functions: to provide metal ions to the electrolyte bath and to repel the positive ions towards the substrate (forming the cathode). The anodes are consumed during the process and need to be replaced regularly to maintain the solution strength. They are fixed on a supporting rail which carries the current to them
- insoluble anodes have only one function: to repel the positive ions towards the steel strip (cathode). They are constructed of current carrying materials that do not take part in the solution reaction. They are used in electrochemical processes where the anode material does not take part in the process, such as electrolytic degreasing. Where there is deposition of material, process solution strength is maintained by additions as make-up, often from a separate feed tank, e.g. a zinc dissolution tank.

2.1 Delivery and storage – workpieces and consumable raw materials

2.1.1 Incoming workpiece and/or substrates to be treated

The workpiece and/or substrates to be treated are delivered in different ways according to size, substrate material, quality and cost, and whether they are intended for in-house treatment or for external shipment to another site or a subcontractor. Jig treatment is most costly, and workpieces may be packed in bulk in stillages for cheaper steel components but are more carefully packaged for more valuable workpieces: from layering in stillages with protective inter-layers (to protect against physical damage and/or corrosion) to high value components such as aluminium alloy aircraft wing sections being individually packed in robust boxes. Automotive bodies are moved individually before and into processes on large jigs (or sleds) see Figure 2.4 [111, ACEA, 2003]. Handling of workpieces can be mechanical or manual. Barrel plating tends to be cheaper, where the quality of the finish is less critical and substrate is robust, and here workpieces are usually transported loose in stillages and often emptied mechanically. For coils, the external initial layers protect the rest of the coil. While small coils (in reel-to-reel processing) can be moved by hand, large scale coils (because of their weight) need specialist equipment, such as air flotation rafts and overhead cranes.

Environmental considerations

The amount and type of packing used and the minimisation of loss of materials by damage to workpieces or substrate.



Figure 2.4: Automotive body undergoing spray pre-treatment
[ACEA]

2.1.2 Consumable raw materials

Raw material inputs will vary according to the installation and will depend on the chemistry the various processes carried out and the workpiece or substrate condition, shapes and surface area throughput. Larger sites will receive some liquid chemicals in bulk by tanker, most IPPC sites will receive at least some chemicals in IBC (Intermediate Bulk Containers) and all will receive liquids in sizes from 2.5 to 210° litre containers. Bulk liquid storage is in bulk tanks or in IBC containers, with smaller quantities being stored ‘as delivered’ and used from the delivery containers.

Large scale solids deliveries may be by bulk tanker, but are more usually in the form of big bags. Most commonly, 25 kg sacks, bags, drums and other containers including disposable packaging, are used for powders, pellets and flakes. Storage of bulk solids may be in silos. Other solids are stored in the containers they are delivered in. [111, ACEA, 2003].

Metals for deposition are usually delivered as anode bars or anode balls, or as salts (see solids, above) but may be in proprietary solutions for chemical treatments (including autocatalytic processes) or precious metal plating.

Smaller quantities of chemicals are used in laboratories and for replenishing costly ingredients, such as in gold solutions or some trace components of process solutions.

The largest amount of chemicals in an installation are usually stored in use in the process line vats and the containment of these chemicals, the use of chemicals in maintaining the solutions and leakage issues are analogous to those for the incoming raw materials.

A description of the storage and handling of chemicals is given in the reference document on BAT for emissions from storage [23, EIPPCB, 2002].

Environmental considerations

Prevention of unplanned releases to surface and groundwaters, and soils.

2.2 Handling techniques for processing and loading for processing

When workpieces are in a suitable state for the core treatments, they are loaded for processing using one of the three transport types described below: [104, UBA, 2003]

- jigs or racks – frames carrying the workpieces singly or in groups
- barrels – plastic cylinders holding many workpieces
- coil – coils or reels of substrate working on a continuous basis.

In a limited number of cases, components are treated *in situ* (see brush electroplating and anodising, below).

Jigs or racks

Jigs (also known as racks or frames) provide both physical support for handling during processing, as well as electrical contact when needed in electrolytic processing. Jigs may be used for all sizes of components from small, such as jewellery and small precision engineered components, to large installations handling parts of aircraft and automotive bodies (see Figure 2.4). Small components are secured by hand on jigs, either by being clipped onto spring retainers forming part of the jig or fixed using copper wire: both systems carry the current in electrolytic processes. Jigs are hung on flight bars: these assemblies are used both to move the jigs through the core process steps and (where the processes depends on electrical current) to carry the electrical current to the jig [128, Portugal, 2003]. Where current is carried, the flight bars need to make good electrical contact: for example, the jigs are hung in each process vat from copper U- or V-shaped cradles. For very large components, the jig may be a large platform or frame without a separate flight bar, and electrical connectors are attached to the jig where necessary.

Figure 2.5 shows finished gold plated components being unloaded from jigs with spring retainers, visually inspected and packed in specialised plastic trays. There are two jigs suspended from a flight bar.

Flight bars can be moved by two types of mechanism:

- transporters, which are hoists travelling on rails running the length of the process line. This is the most flexible type of system and can be programmed for various finish options, with different dwell times in different vats, or operated manually
- beams, where the flight bars are hung on a beam. The beam moves up and down at present intervals. In the up position, the flight bars are moved to the next process vat position. However, the only way of varying the process time in different vats is to change the tank length.

In process lines with low throughput, or small components, jigs may also be moved by hand. Large, individual components, such as aircraft parts or automotive bodies may be moved on conveyor systems or by overhead transporters.



Figure 2.5: Jig or rack plating: unloading finished components
Graingorge S.A., France and Agence de l'eau Seine-Normandie

Barrels

Barrel lines tend to be used for high volume, lower cost work such as nuts and bolts, and can only achieve lower quality finishes than jigs. Barrels are usually hexagonal or octagonal plastic drums, with many holes in the long panels allowing access for the process liquids. The barrels are usually moved by transporter systems, although for very small components (such as contact pins being gold plated) small barrel units can be moved by hand. They are loaded from stillages of components. Usually workpieces are emptied from stillages onto the floor, and the barrels are then loaded manually using a shovel. Large scale barrel operations may use a mechanical loader or a mechanised system. The barrel hangs from cradles which carry current at the appropriate process vats. The barrel spindle carries current to a flexible electrode which trails in the barrel from the central spindle and carries current to the loaded components in the relevant process vats. The barrel is constantly rotated usually via a drive mechanism on the side. The current is then passed through a flexible inert anode which trails in the rotating barrel and current is passed through the contacting workpieces.

Steel coils

Coils can be up to 32 tonne rolls of steel up to 2080 mm wide [119, Eurofer, 2003]. Coils are loaded in an entry loader section and welded onto the end of the preceding coil, see Section 2.9.

Aluminium coils

Aluminium coils up to about 25 tonnes, up to 2200 mm wide and up to about 3 mm thick are processed [118, ESTAL, 2003].

Printed circuit boards

The transport of boards can vary during production, they are moved both as individual boards across rollers in some parts of the process lines and in other parts they are moved in sets on jigs.

Brush electroplating and anodising

This is a specialised technique, developed for selective plating using portable equipment and anodes surrounded by absorbent material that do not require immersion of the part. The method is not generally used for production, but repair of worn or defective parts, e.g. large printing rollers, large bearings, military and aviation parts, statues and other parts too large to process by immersion techniques. [38, Ullmann, 2002/3]

2.3 Workpiece or substrate pretreatment

Workpieces or substrates to be surface treated must be clean from dust, swarf and moulding flash, as well as being corrosion- and grease-free to ensure uniform application and permanent adhesion of the surface treatment. Many workpieces or substrates are oiled to prevent corrosion in transit or from a previous operation such as pressing. Usually (but not necessarily) the workpieces will need to be totally smooth to produce a high quality treated finish. Some preparation of the workpieces may be carried out at the site producing them, but these activities are also carried out at the surface treatment installation [6, IHOBE, 1997].

Activities preparing steel coil and wires prior to surface treatment in coil coating process lines are described in the BREF on the ferrous metals processing industry [86, EIPPCB,].

While virtually all process lines include cleaning or degreasing, where components are heavily oiled or surface preparation is critical, it may be necessary to supplement this by an additional pre-degreasing step. [104, UBA, 2003]

The pretreatment steps not only remove greases and oil, but also remove oxides and provide chemically active surfaces for the subsequent treatment [73, BSTSA,].

Overall environmental considerations

If cleaning is a separate activity to the main processing, the increased handling (such as emptying containers, etc.) may give rise to additional noise [73, BSTSA,].

2.3.1 Mechanical pretreatment

2.3.1.1 Linishing and polishing

Mechanical polishing produces a flowed amorphous surface under the influence of pressure and high local temperatures [121, France, 2003, Finland, 2003 #120]. Individual components are finished using abrasive belts, and then polished with an abrasive paste applied on fabric mops, which removes fine marks and gives a highly polished finish. These activities are carried out less frequently as modern production techniques produce better engineered components than in the past, or use alternative materials such as plastics which can be precision moulded. Where large numbers of workpieces are handled, the linishing and polishing are usually automated.



Figure 2.6: Linishing
Producmetal S.A., France and Agence de l'eau Seine-Normandie

Environmental considerations

Noise and dust are associated with this activity.

Wastes may be hazardous depending on the substrate.

2.3.1.2 Abrasive blasting

This traditionally uses sand or grit, but may use softer, finer abrasives such as ground nut shells. These techniques may be used to de-stress the surface of the workpieces.

Environmental considerations

Noise and dust are associated with this activity.

Abrasive blasting creates solid wastes. With non-ferrous metals, the wastes (a mixture of abrasives and abraded material from the metals) may be hazardous [113, Austria, 2003].

2.3.1.3 Deburring and/or tumbling

Applied to smaller, mass-produced components often followed by barrel treatment. The workpieces are mixed with abrasive stones and tumbled or vibrated for up to several hours [73, BSTSA,]. These techniques can also be used in aqueous media with chemical additives to clean, deburr and pickle the parts.

Environmental considerations

Noise and dust are associated with this activity.

Wastes generated directly may be contaminated with oils, surfactants and abrasive particles, particularly vibratory finishing [73, BSTSA,].

Where used with an aqueous system, the effluent may require specific treatment to eliminate metals in solution and COD. This effluent is often recycled after centrifugation, simple filtration or ultrafiltration. The residues from treatment may be treated off-site in a suitable waste treatment plant or on-site in a physico-chemical waste water treatment plant. The residues may be hazardous waste [121, France, 2003].

2.3.2 Electrolytic and chemical polishing

As well as the mechanical methods, electrolytic and chemical processes are employed in the production of smooth, bright surfaces. Although their function in industry is similar, the principle by which polishing is carried out is very different. While mechanical polishing produces a flowed amorphous surface under the influence of pressure and high local temperatures, chemical and electrolytic polishing are selective dissolution processes where the high points of the rough surface are dissolved faster than the depressions. The potential advantages of these methods are [118, ESTAL, 2003, Finland, 2003 #120, P G Sheasby, 2002 #132]:

- being similar in operation to anodising and electroplating processes, they can be employed together in a single production line, with considerable reduction in plant and simplified control, while mechanical polishing may often be replaced entirely
- they are suitable for bulk treatment and labour costs are appreciably lower, particularly on components not suited to automatic polishing machines
- the surface is clean and gives better subsequent deposit adhesion as well as high corrosion resistance
- the reflectivity and colour are often superior and there is no tendency to ‘bloom’.

Overall environmental considerations

Some of the chemicals used in electropolishing are toxic and this should be taken into account both in the workplace and when disposing of spent baths. For chromium compounds, see Sections 1.4.4.1 for health effects, and Section 2.5.3 for overall environmental considerations.

Spent electrolytes and acids have a low pH and high concentration of dissolved metals including chromium and nickel and may need to be treated before disposal as effluent (see Section 4.16.2). Alternatively, spent electrolytes may be managed as hazardous wastes. Electrolytes for stainless steels deteriorate due to excessive iron in solution [73, BSTSA,].

Rinsing waters may also require treatment for the same reasons.

Acid fumes, particularly those containing hexavalent chromium, may need extraction and treatment. Where nitric acid is used, an air-scrubber may be used to remove nitrogen oxides (NO_x).

There is no associated dust and noise, unlike mechanical polishing processes.

2.3.2.1 Electropolishing

Electropolishing is a commonly used electrochemical method for smoothing, polishing, deburring and cleaning various metals, generally steel, stainless steel, copper and its alloys and aluminium and its aluminium alloys. It is widely used in food equipment, surgical equipment and implants, the pharmaceutical, paper, pulp and food industries, as well as in automotive and architectural applications. Electropolishing removes a fine surface layer electrolytically, and is often used in cases where very smooth and bright finishes are needed. In electropolishing, the workpiece (anode) is immersed in electrolyte and electric current (usually DC) is connected between the workpiece and the cathode. The workpiece becomes polarised and metal ions start to diffuse to the cathode, and metal is removed from the anode. The reaction can be controlled by adjusting bath and process parameters and by choosing the metal or alloy being electropolished.

In these electropolishing processes, different electrolytes are used. Electrolytes are usually mixtures of various acids (sulphuric acid, chromic acid, citric acid, and/or phosphoric acid) and sometimes organic compounds (such as glycerine or diethyleneglycolmonobutylether) are added. [133, Hensel, 2002, 134, CEN/BSI, 1997, 135, Swain, 1996, 136, Webber and Nathan, 2000], [137, ISO/BSI, 2000]

Environmental and other considerations

During electropolishing of stainless steels, hydrogen is formed, which mixes with oxygen at the solution surface. If ignited by a spark, this can produce an explosion. It is therefore advisable to extract gases forming on top of the solution. This is vital when processing the internal surfaces of enclosed vessels, otherwise a serious, possibly fatal, injury may occur. Repeated noise of this type may have an impact beyond the perimeter of the installation (as well as being an occupational health issue).

2.3.2.2 Electropolishing with electric discharge (also known as plasma-electrolytic polishing)

Plasma-electrolytic polishing is an alternative method for some applications. The process differs from conventional electropolishing mostly because of its electrolytes and process parameters used. Instead of mixed acids, these electrolytes are different salt solutions and far more friendly for employees and for environment. In this process, the used electric potential between anode and cathode is in the range of 200 – 400 V DC depending on the solution and temperature (40 – 95 °C) used.

The same process can be used also for plasma-electrolytic oxidation in order to get hard oxide-ceramic coatings.

2.3.2.3 Electrolytic and chemical polishing processes for aluminium

Industrial electrolytic and chemical polishing processes for aluminium are of two types:

- processes designed to replace or reduce mechanical polishing. These provide a smooth, bright, though not a 'mirror', finish, and are characterised by high dissolution rates (between 2.5 and 5.0 μm per minute). In most cases, the best results are obtained on high purity aluminium or its alloys, but some processes may be employed on commercial purity based grades of aluminium, producing a correspondingly lower grade of finish
- processes employed after mechanical polishing. These processes have a low rate of attack and are employed on aluminium reflectors and other components which require a higher specular reflectivity than is obtained by mechanical methods alone. Their use is generally restricted to high purity based materials as reflectivity falls off sharply as the quantity of second-phase constituents present increases.

Hot, highly concentrated acid mixtures are normally used, especially phosphoric acid, sulphuric acid and sometimes nitric acid. The temperature is $>80^\circ\text{C}$.

2.3.3 Solvent degreasing

Solvent degreasing is usually by means of chlorinated hydrocarbons (CHC), alcohols, terpenes, ketones, mineral spirits or hydrocarbons [90, EIPPCB, , 104, UBA, 2003], [73, BSTSA,]. CHCs are used because of their good cleaning efficiency and universal applicability, as well as their quick drying and incombustibility, but their use is restricted by environmental and health legislation. All solvents affect the central nervous system and exposure should be controlled (see environmental considerations, below) [73, BSTSA, , 90, EIPPCB,].

There are two types of process:

- **cold cleaning:** The workpieces and/or substrates are immersed in the solvent or cleaned in a stream of solvent. In some cases, the solvent is pumped round taking the liquid from near the top of a holding tank, leaving dirt to settle at the bottom. The tank is cleaned periodically
- **vapour phase:** The solvent is vaporised in a purpose-built bath and the cold component suspended in the vapour. The vapour condenses on the component dissolving grease and drained off with the dirt and grease, leaving the component clean and dry. The most common solvents are CHCs. As the vapours are heavier than air they are contained in the bath. Hydrocarbon solvent may be used.

The choice of solvents will depend on a number of factors including the substrate to be cleaned, the type of oil or grease to be removed, the previous manufacturing process and the requirements of the subsequent surface treatments. Chlorinated ethanes and ethylenes attack aluminium and should not be brought into contact with substrate, tanks, containers, valves, etc. made of aluminium. Dichloroethylenes in contact with copper should be avoided under all circumstances as explosive acetylides may be formed.

Chlorinated solvents have no flashpoints [73, BSTSA,]. Ketones and mineral spirits may be used, but are flammable. Higher hydrocarbons with a narrow distillation range give the highest flashpoints commensurate with solvent drying from the workpieces and/or substrate.

Environmental considerations

Because of the classification of certain CHCs as potentially carcinogenic materials, their water-endangering potential and problems with emissions to the air, their use is strongly regulated [[93, EC, 2000, 97, EC, 1999]. Most other solvents are either inflammable or not self-drying [73, BSTSA,]

2.3.4 Aqueous cleaning

The workpieces are placed in this process solution for several minutes, or placed in a spray bath. The solution is usually alkaline or neutral but may be acidic and usually working at increased temperatures (40 – 90 °C) because of the improved cleaning effect. The main components of the aqueous cleaning system are alkalis or acids, silicates, phosphates and complexing and wetting agents. Aqueous cleaning systems work either by forming unstable emulsions (known as weak emulsion systems) or stable emulsions. [3, CETTS, 2002, 104, UBA, 2003]

Aqueous chemical systems avoid the use of solvents. The cleaned items can remain wet if the subsequent treatment is water-based, such as electroplating. Process solutions have a short life, dependent on throughput and the amount of oil or grease on the workpieces. The efficiency of aqueous cleaning systems depends on the type and concentration of chemicals, the mechanical effect, the temperature and the time. The mechanical effect can be applied by spray pressure or flowrate, agitation of parts or solution, or by using ultrasonics.

Hot water is used effectively to remove oil and grease, especially from steel panels. It is widely used in the automotive industry.

Strong alkalis and silicates are not suitable for aluminium. Complexing agents (tensides) are not used in aluminium cleaners. For wetting agents, only very specific agents can be applied (for instance, non-anionic agents). Cleaning at a low temperature is possible, from 40° upwards [160, ESTAL, 2004]

Environmental considerations

Energy usage: process tanks operate at 50 – 90 °C and may require fume extraction to remove water vapour and alkaline or acid fumes.

Rinse-waters (including those from air scrubber units) may require simple pH treatment in waste water treatment plants.

Metals can be stripped from the substrate surface (including trace elements such as lead which may have toxic effects). They can be separated after pH adjustment.

Alkaline degreasing agents may contain small amounts of substances of concern, such as nonyl phenols [161, Assogalvanica, 2004].

Used acid or alkali solutions are often treated separately as they create a large pH change which may not be accommodated by continuous flow waste water treatment plants.

Solution maintenance by replacing consumed components and removing the accumulated oil dirt, oil and grease can greatly increase the solution life by various options [73, BSTSA,].

Cleaning solutions may need to be separated from other process effluents to avoid interference with the waste water treatment plant by excess surfactants. Cleaning solutions containing complexing agents should be separated from other waste water streams containing metal ions [73, BSTSA,], see Section 4.16.2.

2.3.5 Other cleaning techniques

2.3.5.1 Air knives

Air knives can be used to remove excess oil and grease from parts [73, BSTSA,]. They are low pressure, high volume systems where air is emitted through precision slits, giving a laminar air curtain, through which components can be passed, either manually or on a conveyor belt. The air heats up due to compression and movement in the system, and this warms oils and greases, assisting their removal. Both the laminar air movement and the temperature also facilitate drying of components.

2.3.5.2 Centrifuges

Centrifuges are used on a batch basis to remove excess grease, and usually applied to smaller workpieces prior to barrel treatment.

2.3.5.3 Dry ice

Blasting with pellets of dry ice by a process called 'Cryoclean' can be used to remove oil and grease as well as particles, paint, etc. The cleaning effect comes from cooling and cracking of contaminant layers, mechanical impact and lifting by the gas formed from sublimation of the dry ice. [115, CETTS, 2003, 116, Czech-Republic, 2003]

Pellets are made from liquid CO₂ with a diameter of 3 mm and length of 8 mm at a temperature of -78 °C. They are accelerated by air to a velocity of 100 to 300 m/s. The pellets release kinetic energy at the surface. On impact, they sublimate immediately. The surface is locally cooled and due to different thermal expansion coefficients of the substrate and any coating and/or contaminants, the cleaning ability is increased.

After use, the pellets of dry ice evaporate so the only waste formed is the solid waste of the stripped coatings. This method is used mainly for cleaning pressing forms and other special parts. In special cases, it is used to strip coatings (organic and metallic).

Environmental considerations

The method is noisy, and requires protection of workers. The waste may contain toxic compounds (such as paints with heavy metals, lead, cadmium, etc.). Workers must protect eyes and respiration. Air extraction and filtration may be necessary.

2.3.5.4 Hand wiping

Hand wiping uses a clean cloth and solvent, or an absorbent such as ground chalk or limestone. This is carried out on large, high value workpieces such as aerospace components. It is also used for small, quality critical components [73, BSTSA,].

2.3.6 Pickling, descaling and desmutting

Pickling and descaling are chemical metal-stripping procedures used to brighten and/or remove oxides from the degreased metallic surface prior to other surface treatment processes [73, BSTSA,]. The bulk pickling of steels is described in the BREF on ferrous metals processing [86, EIPPCB,]. During the pickling processes disturbed or adhering layers, such as scale, oxide films and other corrosion products of the metal, are removed by chemical reaction with an acid-based pickling agent. In order to remove strong oxide layers effectively, specified acid concentrations, temperature and pickling times must be adhered to. Hydrochloric or sulphuric acids are normally used. In special cases nitric, hydrofluoric or phosphoric acid, or mixtures of acids are used. Solutions containing fluorides are necessary for reliably pickling certain alloys. The typical pickling reaction is described by the following chemical equation:

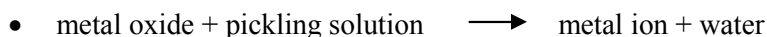

Some erosion of the metallic surface is desirable, but excessive attack of the acid on the basic material is unwanted. Hydrogen is usually formed:

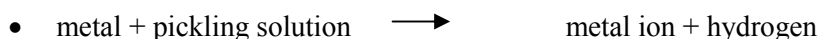

The attack can be reduced by using so-called pickling inhibitors. These also cause an inhibition of hydrogen development, thus minimising so-called hydrogen (or pickling) embrittlement (or brittleness), caused by entrapment of hydrogen in the metal crystalline structure at the surface and diffusion of hydrogen to stress concentration sites in the material. This may cause catastrophic failures in high strength steels [73, BSTSA,].

The concentration of the ions of the dissolved metal increase in the pickling solution while the strength of the free acid declines. The acid consumption associated with the dissolution of metal and metal oxide can be supplemented by adding fresh pickling solution [73, BSTSA,]. However, this technique is limited by the constantly increasing metal content. A maximum iron content of 8 % is recommended for sulphuric acid, 12 % for hydrochloric acid and 2.5 % for phosphoric acid. When the limiting concentrations are reached, the pickling solution must be disposed of completely or partly. [104, UBA, 2003]

The workpieces to be pickled must be completely grease-free, otherwise uneven pickling will occur as the acid attacks grease-free areas only. The use of wetting agents accelerates the pickling procedures as the workpieces are wetted better and more quickly. Iron materials can be de-rusted and descaled in so-called acid degreasing agents without prior degreasing. The commercial acid degreasing agents contain mixtures of wetting agents and emulsifying agents, which can support the emulsification of fats and oils in strong acid media.

The pickling time is reduced with increasing acid concentration and temperature. A maximum pickling effect is reached with a sulphuric acid concentration of 25 %. Above this, the pickling speeds decrease. The optimal temperature is at 60 °C.

The pickling effects can also be accelerated by movement of the workpieces in the pickling solution or movement of the pickling solution by solution injection [159, TWG, 2004].

Hydrochloric acid is also good for descaling and pickling. It works rapidly in most cases, with a concentration of 18 – 22 %. However, its disadvantage is aggressive vapours. Heating up to 30 – 35 °C not only increases the pickling effect, but also the formation of hydrochloric acid air emissions.

Hydrofluoric acid is nearly exclusively used for the pickling of cast iron, for example engine blocks. A concentration of 20 – 25 % (as HF) and temperatures of 35 - 40 °C are generally preferred.

For aluminium, the process is called desmutting, and nitric acid is at concentrations below 150 g/l

Environmental issues

Process tanks may need to be equipped with fume extraction to remove generated aerosols and hydrochloric acid gas and nitrous oxides if nitric acid is used.

Spent pickling solutions require either treatment and disposal through an effluent treatment system or disposal as liquid wastes. Excessive attack of the metal surface removes a significant amount of iron, which can have adverse effects on the waste water treatment systems, such as significantly increased sludge production [158, Portugal, 2004].

Effluents can easily be treated in typical waste water plants.

Maintenance of pickling electrolytes by acid retardation and diffusion dialysis is used in Germany in some cases, such as anodising; it is not widely used in electroplating [124, Germany, 2003].

2.3.7 Etching and descaling of aluminium

Descaling and pickling are not normally applied to aluminium processing because the natural oxide on aluminium is very thin, unlike that on steel. Aluminium oxide removal may not be necessary as part of a pretreatment but as a consequence [118, ESTAL, 2003].

The etching of aluminium and its alloys is usually carried out in sodium hydroxide solutions, fluorides being added as necessary. Zincate treatment is necessary for good adhesion prior to autocatalytic or electrolytic metal plating. This solution is based on sodium hydroxide containing <20 g/l zincates.

2.3.8 Electrolytically assisted pickling, activation and degreasing

Pickling can be enhanced by making the substrate anodic. The non-electrolytic pickling of metals is often followed by electrolytic activation to remove the remains of unwanted residues from the surface, such as oil and dirt, which remain trapped in the micro-roughness of the substrate surface. These are removed by the formation by electrolysis of H₂ at the surface of the cathode and O₂ gas at the surface of the anode [73, BSTSA,]. The basic composition of the solution is similar to alkaline degreasers, although the chemical concentration is generally twice as high. Wetting agents are omitted to prevent foaming; however, cyanides or other complexing agents may be added to improve the activation of steel items. For normal applications, cyanide- and chelating-agent free electrolytes are sufficient. The solution lifetime is mainly determined by dilution through drag-in of rinse-water and drag-out of process solution. [3, CETS, 2002]. This process is not used in anodising [159, TWG, 2004].

Environmental considerations

Process tanks may be equipped with fume extraction to capture vigorously generated aerosols.

Rinse baths are rapidly saturated with dirt, fats and oils.

Rinse effluents and used solutions can be treated as alkaline or cyanide solutions in waste water treatment plants. The waste water can upset the waste water installation because of the amount of oils and grease, and the composition and concentration of components, e.g. phosphates and surface active agents which can interfere with settlement processes [20, VITO, 1998].

2.3.9 Metal stripping

Metal stripping is necessary for the processing of defectively electroplated components without losing the properties of the base material [73, BSTSA,]. It may also be used [73, BSTSA,] for the new treatment of nascent workpieces. It may be also used for the recovery of expensive metals (such as the precious metals), both from the base metals and the coating materials. Often scrap iron substrate metal can only be regenerated if certain metal coatings which cause problems are removed. The metal stripping of jigs and/or of jig contacts used in the electroplating process extends the life of the jigs and recovers the metal deposited.

To preserve the form of the surface to be stripped, the metal stripping techniques should remove the coating material quickly and safely and not attack the base metal. In exceptional cases, [73, BSTSA,] electrolytic activation of the coat can be necessary, for example with chemical chrome stripping. Chemical procedures are simple in application and they require less expenditure on plant equipment. On the other hand, electrolytic procedures usually work more quickly, more economically and with more control. They are therefore preferable for activities such as the metal stripping of rack contacts.

Environmental considerations

The use of strong acids can generate spillage capable of attacking concrete floors and subsequently polluting the soil and any groundwater beneath with acid and the dissolved metals. The disposal of used acid stripping solutions may exceed the treatment capacity of effluent systems. Acid fumes and mists are caused by reaction with the metals and substrate. These can cause local air problems, health effects in staff and deterioration of equipment in the installation.

Stripping of previous treatments is often carried out as a batch process outside of the normal process controls of an installation. They are a potentially significant source of breach of permit conditions and pollution from the industry.

There can be increased waste production (in sludges from treatment and used acids), as well as wasted energy, water and raw materials where defective components are stripped for reworking.

2.3.10 Pretreatment of plastics (etching)

Pretreatment is essential in the surface treatment of plastics by autocatalytic plating (see Section 2.5.8) and printed circuit boards (see Section 2.11).

2.3.10.1 Conditioning of plastics

This provides wettability of the surface as a prerequisite for subsequent voidless covering and good adhesion of metal layers [3, CETS, 2002, 77, BSTSA,].

The process solution contains sulphuric acid (<20 % by volume) or sodium hydroxide and carbonate (<10 % by volume), water soluble organic biodegradable solvents (alcohol, glycol derivatives).

For PCB boards, cleaning using a mix of pumice and water may be used to provide a micro-rough surface for the subsequent adherence of layers [125, Ireland, 2003].

Environmental considerations

Acid effluents may require pH adjustment in waste water treatment plants.

2.3.10.2 Etching or pickling of plastic

The pickling of plastic is a prerequisite for good metal adhesion. It is carried out in an aqueous mixture of chromic acid (up to 380 g/l) [73, BSTSA,] sulphuric acid (380 g/l) and wetting agent. It is applied to ABS-type plastic surfaces to oxidise and dissolve the butadiene component, thus generating a micro-rough surface [3, CETS, 2002].

Environmental considerations

Process tanks may be equipped with fume extraction to remove small amounts of generated aerosols and acid gases.

The solution lifetime can be extended by membrane electrolysis to oxidise Cr(III) to Cr(VI).

Effluents can easily be treated in a similar manner to other solutions containing hexavalent chromium in waste water treatment plants.

2.4 Drag-out and rinsing

Drag-out is the liquid from the previous process which adheres to the workpiece or substrate surfaces. Rinsing is necessary:

- between most process steps to prevent cross-contamination of process solutions
- to ensure there is no deterioration of the workpiece and/or substrate surface by residual chemicals, such as by over-reaction or by staining by the drying of dissolved chemicals.

A reduction of drag-out is a primary measure for minimising losses of chemicals, operating costs and environmental problems in rinse-waters. In some processes, such as etching in anodising, a certain amount of drag-out is used to maintain the solution by preventing the build-up of by-products, such as in aluminium etching [159, TWG, 2004].

Rinsing is therefore a common activity carried out after nearly all process steps in surface treatment [3, CETS, 2002]. Figure 2.7 shows a section through a typical jig plating line with six rinsing stations [65, Atotech, 2001].

Rinse-water may vary in quality depending on the process requirements (see Section 2.12.2). Many rinsing techniques have been developed to reduce water consumption to a minimum, and some of these are discussed in Sections 4.6 and 4.7. There is usually a balance to be sought between achieving the requisite cleanliness of the surface, the quality and quantity of the water used, and the way rinsing is carried out.

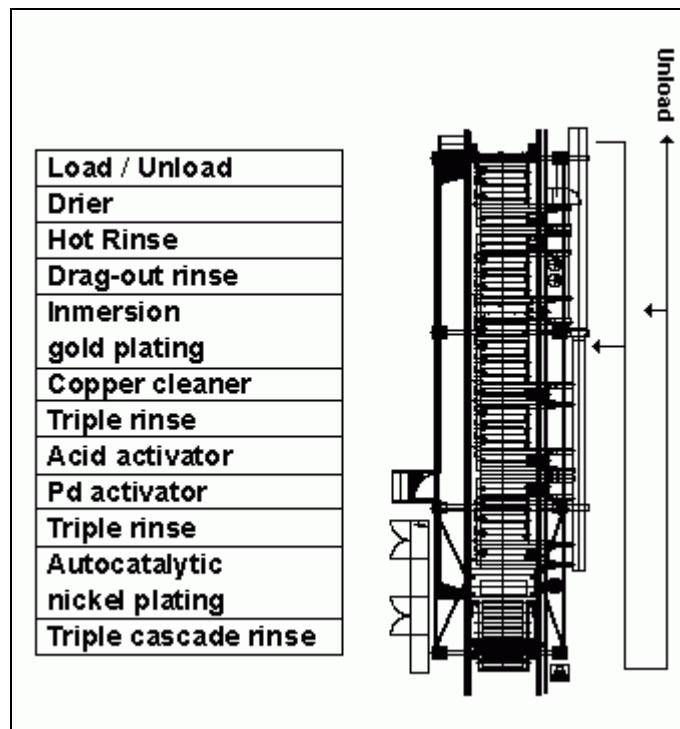

Figure 2.7: Section through a jig plating process line for PCB production (Atotech Deutschland GmbH)

Environmental considerations

Rinsing is one of the largest potential sources of waterborne contamination as rinse-waters carry all the process chemicals from an activity. In many cases rinse-waters are treated prior to discharge (treatment options are discussed in Section 4.16. Key issues are:

- minimisation of the loss of materials, including possible re-use of rinse-water
- metals: these are conservative, i.e. can only be treated and moved to another waste stream, but cannot be destroyed
- cyanides: these are usually treated by oxidation
- complexing agents: (including cyanides) these may need to be treated separately to enable metals to be successfully treated subsequently
- surfactants, brighteners and other additives may interfere in waste water treatment or have their own environmental impacts
- other cations may have local water quality effects.

Rinsing is also one of the two largest water usages in installations (the other large use is cooling).

2.5 Core activities

2.5.1 Copper and copper alloy plating

[3, CETS, 2002] Copper plating is common for items in daily use, such as coins, and buttons or zip fasteners with a patina for haberdashery. These types of workpieces can be plated on jigs or in barrels. Copper plating is also essential in printed circuit board manufacture, see Section 2.11.

2.5.1.1 Cyanide copper

Cyanide copper low temperature electrolytes are necessary for strike plating on steel and zinc die casts to prevent spontaneous cementation of copper and poor adhesion of the subsequent metal deposit. This type of solution is based on copper cyanide and sodium cyanide, with a copper concentration of 15 – 20 g/l. Copper strike layers are usually no thicker than 2 - 3 μm .

Thicker layers (6 - 8 μm) are achieved with potassium cyanide and potassium hydroxide based high performance electrolytes at a metal content of 25 – 50 g/l, mainly for barrel plating and others.

Another high performance electrolyte is based on copper cyanide and sodium cyanide with potassium sodium tartrate providing higher current densities system, enhanced brightness of layers and reduces the tendency to anode passivation. The metal content is 40 – 60 g/l.

Potassium carbonate is generated in potassium-based systems during processing. This disrupts bright copper deposition and causes roughness at concentrations beyond 90 g/l.

Environmental considerations

Process tanks may be equipped with fume extraction to remove generated aerosols.

Sodium-based solutions can be regenerated by batch or continuous precipitation of sodium carbonate.

Potassium-based electrolytes have to be discarded as soon as the content of potassium carbonate exceeds 90 g/l.

Effluent can be treated in typical waste water plants, with a cyanide oxidation stage.

2.5.1.2 Acid copper

These solutions are now the usual choice for copper plating [124, Germany, 2003]. Due to their excellent levelling capability, acid copper electrolytes based on copper sulphate and sulphuric acid are used to make polishing and buffing redundant prior to decorative bright nickel and copper plating on furniture frames, bathroom fittings, wire work, etc. The normal copper content is 50 – 60 g/l and sulphuric acid is 60 – 90 g/l.

An important technical application of acid copper electrolytes is for through-hole, panel and pattern plating of printed circuit boards and multilayers. Sulphuric acid enhances the conductivity, the macro-throwing power and provides fine crystalline and ductile layers. In such electrolytes, the concentration of sulphuric acid is in the range of 180 – 200 g/l and the copper concentration is 20 g/l.

The solutions are also cyanide free, do not suffer from carbonate build-up and are more electrolytically efficient.

Environmental considerations

Process tanks may need to be equipped with fume extraction to remove aerosols generated by air agitation of the plating solution.

Effluents can be treated in typical waste water plants for low pH and to remove copper.

2.5.1.3 Pyrophosphate copper

Pyrophosphate copper electrolytes no longer play an important role. They are based on copper pyrophosphate (110 g/l) and potassium pyrophosphate (400 g/l). Additives are citric acid (10 g/l) and ammonia (3 g/l) [124, Germany, 2003].

They are used for special technical applications such as shielding on heat treated parts, as a drawing aid for wires, and for other thick bright layers that need little or no polishing, to prevent hydrogen embrittlement and as an intermediate layer below nickel and silver.

Pyrophosphate electrolytes can also be used for through-hole and panel plating of printed circuit boards and multi layers, but are currently substituted mainly by acid copper electrolytes.

Pyrophosphate is continuously decomposed by hydrolysis if pH is not maintained sufficiently, shortening the lifetime of the process solution. Appropriate regeneration means are not currently available. However, properly maintained baths can last more than 10 years [129, Spain, 2003].

Environmental considerations

Fume extraction is normally used at process tanks.

Effluents have to be treated with lime, as sodium or potassium hydroxides do not precipitate copper from the pyrophosphate.

Due to the ammonia content, separate treatment from other effluents containing metals is required.

2.5.1.4 Brass

Brass is predominantly an alloy of copper and zinc although nickel, tin, or lead may be added. A mixture of copper and zinc cyanides in solution are widely used to deposit copper and zinc alloys for decorative purposes. They are alkaline electrolytes containing between 8 – 15 g/l copper and 5 – 30 g/l zinc (depending on the formulation used). The total sodium cyanide content can vary from 70 to 90 g/l and working pH around 10. The deposited alloy contains 65 to 80 % of copper and the colour is light yellow. It can be used as a flash over a bright substrate or if heavier deposits are used then different finishes can be obtained through a subsequent chemical colouring of the deposit.

2.5.1.5 Bronze

Bronze is copper alloyed with tin and zinc. Cyanide bronze alloy is used as a decorative plating process. It is used as a substitute for nickel in jewellery as a 'nickel free' coating to avoid skin allergy effects. Acid bronze is under development [124, Germany, 2003].

The metal concentration in this stannate and cyanide-based electrolyte is 4 – 10 g/l of stannate, 4 – 20 g/l copper, and 1 – 4 g/l zinc, with 6 – 10 g/l potassium cyanide. It is used in two different colours: white or yellow bronze.

Lead is used in low concentration as a brightener in some electrolytes. Its future use in many products is banned by new directives [98, EC, 2003, 99, EC, 2000].

Cyanide oxidises with the passage of current to carbonate. Solutions have to be discarded as soon as the carbonate level exceeds 40 g/l.

Environmental considerations

Process tanks may need to be equipped with fume extraction to remove generated aerosols.

Effluent can be treated for pH, cyanide and metals in a typical waste water treatment plant with a cyanide oxidation step.

2.5.2 Nickel electroplating

[73, BSTSA,] Nickel electroplating and electroless plating processes are used in a wide range of industrial and consumer applications. Although the prime function of these processes is to improve the resistance of substrates to corrosion, wear and abrasion, nickel provides a smooth, highly reflective and corrosion-resistant coating below a range of other coatings for decorative finishes.

Nickel plating processes - including both electrolytic and electroless (autocatalytic) systems - can conveniently be considered in seven separate categories.

Nickel/chromium electroplating

The most important application of nickel is in nickel/chromium electroplated coatings, commonly called 'chrome plating'. They consist of a very thin chromium topcoat (1 %) over an undercoat of nickel (99 %). Nickel provides a very smooth, brilliant corrosion-resistant finish.

Nickel electroplating with other topcoats

Brass, gold and silver topcoat systems are used as alternatives to chromium.

Nickel electroplating

Nickel can be used on its own without any topcoat. Generally, this is only for engineering purposes, such as refurbishment of worn components.

Nickel composite electroplating systems

Almost uniquely, nickel matrixes can be formed in which inert, non-metallic particles, such as silicon carbide, diamond or PTFE are incorporated by co-deposition to improve engineering properties such as hardness, abrasion resistance and coefficient of friction.

Nickel alloy electroplating

Electrodeposited nickel alloys of commercial significance include zinc-nickel, nickel-cobalt, and nickel-iron.

Nickel electroforming

Nickel electroforming is a unique process that allows articles to be produced by the electrodeposition of relatively thick nickel layers - it is a vital part of the process of manufacturing compact discs, DVDs, holograms and screen printing cylinders.

Electroless nickel plating

This is a chemical process giving hard uniform coatings. They can also be deposited on materials that cannot be electroplated, such as plastics and some alloys. A full description of these processes is given in Section 2.5.8.

Overall environmental considerations

The health issues related to nickel metal and its soluble salts, and the principal areas of concern are described in Section 1.4.4.1.

Nickel solutions are likely to require agitation and the choice of agitation can affect the amount of airborne pollutants, see Section 4.3. Effectiveness of distribution can be improved by the addition of wetting agents.

Exhaust extraction is regularly used and mist eliminators are often employed and the effluents may be treated with other waste waters (see below).

Waste waters can be treated in a typical waste water treatment plant. However, waste waters containing nickel must be separated from cyanide-bearing waste waters, as nickel forms stable complexes with cyanide which are difficult to treat. Contact with other complexing agents should also be avoided.

Solid residues will require management as a hazardous waste [92, EC, 1991, 100, EC, 2000].

Substrate considerations

Nickel is regularly deposited onto a wide range of metallic substrate materials commonly used in manufacturing processes such as steel, copper, brass, zinc alloys, aluminium, and magnesium as well as onto a range of plastics substrates.

It can successfully be plated directly, achieving good adhesion, onto some of these substrates (steel, copper and lead-free brass) if the correct cleaning and other pretreatment processes (see Section 2.3) are properly carried out.

Zinc alloys are, however, susceptible to corrosive attack in acidic nickel plating solutions and consequently require a layer of copper deposited from a cyanide solution (see Section 2.5.1) before nickel can be successfully deposited.

With aluminium and its alloys, because of their very high surface reactivity, it is necessary to deposit a layer of zinc (produced by non-electrolytic chemical treatments known as the 'zincate' or 'double zincate' processes) before a layer of copper can be applied, again from a cyanide-based solution. Magnesium alloys require similar treatment.

2.5.2.1 Watts-type nickel solutions

Watts-type nickel solutions account for the majority of solutions used in the nickel plating industry, including those used for nickel-chromium plating, nickel with other topcoat systems and composite nickel plating. Nickel sulphate (240 - 375 g/l) is used with nickel chloride (35 - 60 g/l) and boric acid (30 - 45 g/l). Operating temperatures can range from 25 to 70 °C although the more restricted range of 50 to 60 °C is more common. The pH is normally 3.5 - 4.5. Formulations with a nickel chloride content at the higher end of the range may be used to achieve increased deposition rates.

Watts-type solutions can be used without any additions to produce dull nickel deposits, although wetting agents are almost always added to reduce gas bubble retention on the nickel surface which would result in 'pitting'. However, Watts-type solutions are most frequently employed with the addition of organic compounds. These modify the metallurgical structure of the nickel to produce either a lustrous and fully bright appearance or alternatively semi-bright or satin nickel deposits. As well as altering the visual appearance of the nickel, these additives also inevitably bring about changes in deposit ductility, hardness and internal stress. Typical additions depend on the required function of the nickel deposit and varies from a small amount of organic semi-brightener (<1 ml/l) and wetting agent (<1 ml/l) for a semi-bright finish to primary and secondary brighteners at 10 - 20 ml/l and <10 ml/l wetting agent for a bright finish.

There are many types of organic compounds used to modify the properties of deposits produced from Watts-type solutions. In general, they are added as proprietary mixtures.

If regularly analysed, used and maintained with care, Watts-type solutions can have an almost indefinite working life. Nickel metal deposited at the cathode is rather more than fully replenished by that dissolved at the anode since the cathode efficiency is normally only between 96 – 98 %, compared to an anode efficiency of 100 %. This small difference in efficiencies is normally compensated for by removal ('drag-out') of solution from the process tanks by work being carried forward into the rinsing system. In systems where 'drag-out' is low, the solution concentration may actually increase; this may require treatment to keep the concentration within operating limits.

The problem most likely to shorten the working life of the nickel solution is the introduction of contamination which can be either inorganic or organic in nature.

Inorganic contaminants can be introduced by an impure water supply, solution carried forward into the nickel solution from those preceding it in the process chain (e.g. cleaning solutions) or metallic components accidentally dropped into the nickel solution, such as work falling from jigs, subsequently dissolving into the process solution. Some inorganic contaminants (Fe) can be removed by measures such as high pH precipitation and others (Cu and Zn) by low current density electrolysis known as 'plating out', see Section 4.11.9.

A considerable number of organic contaminants can be removed simply by filtration over activated carbon or using adsorber polymers. Others may require additional treatment either with hydrogen peroxide or with potassium permanganate in order to break down the compound into simpler ones that can then be removed by active carbon treatment.

Environmental considerations

See overall environmental considerations.

The wetting agents used do not usually interfere with typical waste water treatments.

With suitable maintenance and rinsing measures, closed loop operation can be achieved, reducing effluent treatment requirements and increasing raw material and water conservation.

2.5.2.2 Nickel sulphamate-based solutions

These solutions are widely used, and most frequently in electroforming applications where the low internal stress of the deposits they produce is absolutely vital. In these cases chloride-free solutions can be used (but only if a form of sulphur-activated nickel anode material is employed) to reduce deposit stress to a minimum. They are also used in barrel plating operations and reel-to-reel, since their higher electrical conductivity allows faster deposition rates to be used, and for thicker layers (>2000 μm).

Generally, sulphamate-based solutions are not used in situations where Watts-type solutions will prove effective due to their higher cost.

The solutions are based on nickel sulphamate (rather than nickel sulphate) in concentrations ranging from 350 to 600 g/l of the tetrahydrate salt, allowing a higher current. These solutions always contain boric acid (35 – 45 g/l) and frequently nickel chloride (1 - 15 g/l).

These solutions normally operate in similar temperature and pH ranges as those used for Watts-type solutions although high concentration sulphamate solutions that are used to achieve high metal deposition rates, using current densities up to 35 A/dm², are often operated at around 70 °C.

Sulphamate-based solutions are frequently used without any additions, other than wetting agents to reduce 'pitting'. However, selected organic compounds, such as saccharin and naphthalene tri-sulphonic acid, can be added to the solution to increase deposit hardness or to control deposit internal stress.

Like Watts-type solutions, those based on nickel sulphamate can have an almost indefinite life if analysed regularly and carefully maintained. There is, however, an additional complication to be considered in relation to the chemical and electrochemical stability of the sulphamate anion. At higher temperatures and lower pH values this will hydrolyse to produce sulphate ions plus ammonium ions in solution. The ammonium ion increases the deposit stress and hardness to unacceptable levels and, furthermore, cannot be removed from the solution. In addition, if the anodes in the process solution become passive, the sulphamate anion will undergo electrochemical oxidation to produce an unspecified mixture of by-products that radically and detrimentally affect deposit properties.

The avoidance of inorganic and organic contamination and treatment are as for Watts-type solutions.

Environmental considerations

Issues relating to solution loss by 'drag-out' and effluent treatment are the same as for Watts-type ones.

2.5.2.3 Nickel chloride-based solutions

Solutions based on nickel chloride have very limited uses due to the very high internal stresses of the deposits they produce. One exception is the Woods nickel strike solution which normally consists of 240 g/l of nickel chloride hexahydrate plus 125 ml/l hydrochloric acid and is operated at 20 - 30 °C. It is used for one specific purpose only: to provide an initial adherent nickel layer on the surface of materials, such as stainless steel and nickel-chromium alloys, where it is difficult to achieve adhesion due to the naturally forming passive oxide film.

2.5.2.4 Nickel sulphate-based solutions

Solutions based on nickel sulphate and not containing nickel chloride are only rarely used as they do not promote good dissolution of the nickel anode material. Formulations similar to the Watts-type solution (but without chloride) can be used when it is vital to use inert anodes in order to deposit into highly inaccessible recesses.

A sulphate-based (70 g/l nickel sulphate plus 100 g/l sulphuric acid) nickel strike solution is sometimes used for a similar purpose as the Woods solution (see above).

2.5.2.5 Other nickel plating solutions

Solutions based on nickel fluoroborate are mentioned in literature but currently find little, if any, commercial application.

2.5.2.6 Nickel alloy plating solutions

Nickel-cobalt alloys are used in electroforming because they are harder than pure nickel and nickel-iron alloys find applications in the electronics industry, generally related to their magnetic properties. Solutions used for depositing both types of alloy are normally based on the standard Watts-type or nickel sulphamate formulations, with the same issues of operation and maintenance.

Nickel-iron processes, however, require special additives to stabilise the ferrous ions in solution and prevent spontaneous oxidation to the ferric state.

Nickel-zinc alloy plating processes that produce alloys containing 10 - 14 % nickel have been developed recently and are becoming increasingly important since they can provide almost 10 times the level of corrosion protection that can be achieved with pure zinc (see Section 2.5.4.).

2.5.3 Chromium plating

[3, CETS, 2002] Chromium plating has found wide usage both as a decorative surface finish (bright chromium plating) and as a functional coating (hard chromium plating), because of its typical high hardness and wear resistance properties. It is also widely used in packaging applications (see Section 1.3.2).

For decoration, often referred to as bright chrome or bright chromium, it is usually applied as a thin layer to prevent the corrosion of the very level and bright surfaces generated by bright nickel undercoats. Deposit thickness is generally in the range 0.1 to 0.4 μm [73, BSTSA, , 124, Germany, 2003], with a treatment time from 2 to 13 minutes [73, BSTSA]. The finish has a typical silver-bright colour and has a very high resistance to tarnishing.

Bright chromium can be plated either from a hexavalent or trivalent chromium electrolytes [122, UBA, 2003].

Hard chromium plating (usually known as hard chrome) consists of heavy deposits applied on particular components (drive shafts, hydraulic cylinders, aircraft landing gear [73, BSTSA,] pins, valves, etc.) to give high resistance to mechanical and wear damage. Hard chromium plating can only be plated from hexavalent chromium electrolytes.

Aerosols are generated from the hexavalent process solution by significant cathodic hydrogen evolution. The health effects of hexavalent chromium are described in Section 1.4.4.1. Theoretically, trivalent processes based on a chloride solution may produce hazardous organic halogens (AOX) and chlorine gas, but production solutions prevent this by additives reducing the chlorine. There is no problem with sulphate-based solutions.

Further issues relating to Cr(III) and Cr(VI) are discussed in Section 4.9.6. Annex 8.10 contains a spreadsheet setting out all the comments received and their validation.

Overall environmental considerations for hexavalent chromium

Process tanks are normally equipped with fume extraction to remove hexavalent chromium aerosols.

Fume suppressants may be used to control foaming and to reduce the amount of aerosol, whether in conjunction with fume extraction or not [73, BSTSA,]. However, the suppressants are based on PFOS, which is toxic and persistent [73, BSTSA,].

Extracted vapours may be treated through a suitable mist eliminator and the wash liquor treated with other chromium effluents.

Effluents may be treated in a typical waste water treatment plant, with reduction of Cr(VI) to Cr(III) followed by flocculation and precipitation.

Cr(III) solutions do not require separation and reduction prior to treatment.

2.5.3.1 Bright chromium plating (hexavalent chromium electrolytes)

Bright hexavalent chromium plating electrolytes are based on chromic acid (80 - 400 g/l), sulphate as the primary catalyst (0.8 - 5.0 g/l) such as fluoride ions (<2 % of the concentration of the chromic acid). Where high corrosion protection is required so-called 'micro-cracked or micro-porous' chromium coating can be applied using readily available techniques, with a thickness from 0.7 to 0.8 μm , and a treatment time of 7 - 8 minutes [113, Austria, 2003].

Decorative chromium coating properties are determined by the characteristics of the nickel underlayer, by the CrO_3 /catalyst ratio and by the operating temperature (20 – 45 °C) [73, BSTSA,]; [124, Germany, 2003].

Environmental considerations

See overall environmental considerations for hexavalent chromium, above.

2.5.3.2 Bright chromium plating (trivalent chromium electrolytes)

Bright trivalent chromium electroplating electrolytes are based on chromium III compounds, such as sulphate or chloride, together with proprietary chemicals. The electrolyte contains only about 20 g/l of the trivalent chromium, compared with about 200 g/l of chromic acid in the hexavalent chromium process.

Currently, trivalent chromium can only be used for decorative finishes, and cannot replace hexavalent chromium for hard chrome plating (see Section 4.9.8.3) [124, Germany, 2003]

The use of trivalent chromium eliminates the carcinogenic and other hazards associated with hexavalent chromium in the workplace. Fume extraction and scrubbing, or fume suppressant are not required for hexavalent chromium. However, additives are required to prevent the formation of free chlorine and AOX.

The lower electrolyte concentration has a lower viscosity than the hexavalent electrolyte. This results in better draining of plated parts, and subsequently less drag-out, less loss of electrolyte, less effluent treatment required and less chromium-containing waste being produced.

Environmental considerations

There is no hexavalent chromium aerosol to control, but fume extraction may be required to deal with any acid fumes [115, CETS, 2003, 124, Germany, 2003].

Fume extraction will assist with, providing evaporation and sufficient volume reduction for additions made during solution maintenance [124, Germany, 2003] or returned drag-out from rinsing processes. However, evaporation may be needed.

The significantly reduced drag-out losses result in much reduced associated effluent treatment and sludge disposal requirements: up to 90 % reduction is possible.

The waste water requires less chemical treatment as the chromium is already in the trivalent state and will precipitated at a suitable pH.

2.5.3.3 Black chromium plating

[113, Austria, 2003]

Black chromium finishes can be achieved for decorative black pieces and on the same substrates as for bright chromium plating. They are also plated onto a preceding nickel layer. Usually, they are treated in emulsions to achieve a decorative finish after the plating process (see Section 2.5.11). They are based on hexavalent chromic acid electrolytes (350 - 520 g/l) and catalysts (nitrates, fluorides). The layers are porous and <1 μm .

Environmental considerations

See overall environmental considerations for hexavalent chromium, above.

Although not usually required, there may be a need to treat nitrates and/or fluorides in any waste waters.

2.5.3.4 Hard chromium plating

[3, CETS, 2002, 74, BSTSA,] Hard chromium plating electrolytes are based on chromic acid (180 – 350 g/l) and on one of the following catalysts:

- sulphate ions (1.8 – 6.0 g/l)
- mixed sulphate and fluoride ions (<2 % of the content of the chromic acid)
- pre-prepared proprietary fluoride-free (<2 % of the content of the chromic acid).

The catalyst choice is fundamental to the efficiency of the electrolyte (from 25 - 33 % [73, BSTSA,] for the sulphate catalyst to 25 – 27 % for the pre-prepared proprietary fluoride-free type). The type of catalyst used, and the operating temperature have a great influence both on the physical properties (cracked, micro-cracked and crack-free coatings) and on the chemical and mechanical properties, e.g. the corrosion and wear resistance, the mechanical workability, etc.

Environmental considerations

See overall environmental considerations for hexavalent chromium, above.

Due to the long plating times and high process temperatures (50 - 60 °C) there is usually sufficient evaporation to use rinse-water returned from the subsequent rinsing station. This may enable closed loop operation, with or without an evaporator. Alternatively, there may be high water consumption [73, BSTSA,].

2.5.4 Zinc and zinc alloy plating

[3, CETS, 2002, 78, BSTSA,] Zinc and zinc alloy coatings are the most widely used electrolytic surface treatment, providing corrosion resistance and/or cheap decorative coating to a very wide variety of iron and steel items for the automotive, construction and other industries. For example, they are used for steel sheet or wire, screws, washers, nuts, bolts, shopping trolleys, construction frames (chassis) and casings for domestic appliances (such as washing machines) and many other kinds of applications (see Section 1.1).

Zinc layers require post-treatment (see Section 2.5.17): in conjunction with various coatings, zinc layers of only 2.5 –18 µm thick will be sufficient to protect parts for their whole working lifetime [159, TWG, 2004].

Zinc plating has been in existence for a hundred years and because of its wide application, many different electrolyte systems are in use. The most common ones are described below.

Overall environmental considerations

Zinc ores contain cadmium. At the purity used for zinc electroplating, anodes contain about 1 gram of cadmium per tonne of zinc or 0.0001 %. EN 1179: requires a zinc purity of 99.995 %. The maximum amount of cadmium allowed is 0.003 %, although in practice, this is about 0.0003 % or 3 g per tonne [124, Germany, 2003] Trace quantities of cadmium may therefore appear in the effluent. These traces are largely removed in typical waste water treatment plants, and will be in the sludge produced. The quantities in either treated effluent or wastes are not usually significant. Treatment to remove zinc to regulatory levels are usually sufficient to remove this incident cadmium. If necessary, additional steps such as filtering may be added (see Section 4.16.10 [124, Germany, 2003].

2.5.4.1 Alkaline cyanide zinc

This is used mainly for technical (non-decorative) corrosion-resistant layers. The process electrolytes are easy to operate, and have compositions of zinc oxide (10 – 30 g zinc/l), sodium hydroxide (80 – 120 g/l) and sodium cyanide (5 – 100 g/l). They operate at pH values close to 14, using both soluble and insoluble anodes.

Alkali zinc gives coating with good post-forming properties. Some sources suggest this is due to a fine structure of the deposit, others that is due to the cleaning action of the cyanide solution giving good adhesion [73, BSTSA,].

The cyanide-based electrolyte has good throwing power into holes and blind spaces.

The plating solution has low conductivity, thus a higher voltage (6 - 8 V for jig plating, 10 -15 V for barrel plating) and a higher energy demand is needed. [73, BSTSA,] Carbonate build-up from cyanide decomposition can be dealt with by crystallising out (see Section 4.11.4), which also removes metallic impurities in the electrolyte.

The current efficiency is from 50 % to 75 % on a well-run process at an average current density of 2A/m^2 [73, BSTSA,], but decreases with increasing current density.

Fume extraction of the process tanks to remove aerosols may be used.

Environmental considerations

There is an industry tendency towards decreasing the cyanide content because of environmental and safety reasons.

Cyanide in rinse-waters can be readily oxidised by several methods in the waste water treatment plant.

Zinc can be readily removed in a typical waste water treatment plant.

2.5.4.2 Alkaline cyanide-free zinc

These are mainly applied for technical corrosion-resistant layers (non-decorative). The process solutions contain zinc oxide (5 – 15 g zinc/l) and sodium hydroxide or potassium hydroxide (100 – 150 g/l). This process may require better pre-cleaning treatment than for cyanide solutions [73, BSTSA,]. The process can give better metal distribution than cyanide electrolytes.

The plating solution has a low conductivity, thus a higher voltage (6 - 8 V for jig plating, 10 - 15 V for barrel plating) and higher energy demand is needed

Current efficiency 65 - 70 %, decreasing with increasing current density. 70 – 85 % is achievable at 2A/m^2 for well-managed processes [129, Spain, 2003, CETS, 2003 #115].

Environmental considerations

Zinc from rinses can be readily removed in an waste water treatment plant.

Aerosols from the bath can be reduced by using wetting agents, which create a foam blanket over the bath.]. However, the suppressants may be based on PFOS, which is toxic and persistent [73, BSTSA,].

Air extraction may be required from the plating vats and any external dissolution tank for zinc metal (see Section 2.13.3[113, Austria, 2003].

This process has a much higher energy demand than other zinc-processes (cooling, lower current efficiency). Potassium electrolytes have better current efficiency than sodium electrolytes [113, Austria, 2003].

2.5.4.3 Acid zinc

Acid zinc electrolytes give bright decorative layers, and used, for example, on furniture frames, shopping trolleys and baskets. In conjunction with post-treatments, they provide corrosion resistance comparable with finishes from alkaline-type electrolytes. Metal distribution is poor to acceptable, but this improves with warm electrolytes.

Electrolytes contain zinc chloride (30 – 55 g zinc/l), potassium and/or [124, Germany, 2003] sodium chloride (130 - 180 g/l) [116, Czech-Republic, 2003], boric acid (10 – 40 g/l) and wetting agent. Only soluble anodes are used. The solutions have good conductivity and high cathode efficiency, typically 93 - 96 %. It has a lower energy demand than alkali processes [73, BSTSA,].

Plating tanks may be equipped with fume extraction hoods to remove chloride-containing mists, thus preventing the corrosion of equipment.

Environmental considerations

Current efficiency of the electrolyte means lower power consumption.

If the extracted air is passed through mist elimination, effluents may require treatment to adjust pH and remove zinc.

Effluents may be easily treated in typical waste water treatment plants.

Acid zinc electrolytes generate more solids in effluent treatment than alkali cyanide processes, resulting in possibly four times as much solids. This may be due to increased dissolution of steel substrates, where the iron both bulks and acts as a flocculant in waste water treatment (Personal communication, D. Hemsley).

2.5.4.4 Zinc alloy plating

Zinc alloy coatings provide extended corrosion resistance and the main use is for automotive applications (see Sections 1.1 and 2.9).

The main zinc alloys deposited are:

- zinc-iron (<1 % Fe), from alkaline cyanide-free electrolytes
- zinc-cobalt (<3 % Co), from acid or alkaline cyanide-free electrolytes
- zinc-nickel (<15 % Ni), from acid (ammonium chloride-based) or alkaline cyanide-free electrolytes. Alloys containing 10 % - 14 % nickel have been developed recently and are becoming increasingly important since they can provide almost 10 times the level of corrosion protection than can be achieved with pure zinc. They can be deposited either from acidic chloride-based solutions or from alkaline solutions where the relatively low concentration of nickel in solution (1 - 2 g/l) is stabilised by the addition of small amounts of amines. The alkaline solutions are becoming the preferred formulations since they give a more consistent alloy composition on complex work geometry [115, CETSA, 2003].

Environmental considerations

Plating tanks may be equipped with fume extraction hoods to capture aerosols or ammonium chloride fumes.

The extracted air may be passed through mist elimination.

Alkaline cyanide-free effluents are treated in typical waste water plants.

Treatment of effluents from ammonium chloride-based electrolytes is difficult and has to be effected separately. Recovery of drag-out can be close to 100 % (closed loop operation) and this facilitates effluent treatment.

For zinc-nickel, the dilution factor that occurs in rinse-waters generally overcomes the complexing effect of the amines so that special treatment is not required to remove the nickel from the effluent. If it is necessary to dispose of quantities of undiluted process solution, however, chlorination treatment will be necessary to destroy nickel amine complexes before the nickel can be precipitated from the effluent stream [73, BSTSA,].

2.5.5 Cadmium plating

[114, Belgium, 2003, 115, CETS, 2003, 121, France, 2003] Cadmium is mainly used to protect parts made of steel, and aluminium or titanium alloys. It has particular properties: a low risk of hydrogen embrittlement, a low friction coefficient and constant torque for fasteners, and has better throwing power and penetration as well as better corrosion resistance than zinc. It's toxicity has resulted in it being restricted to specific vital technical uses where it is difficult to replace in aviation and aerospace, military equipment, mining and nuclear industries and some safety critical electrical contacts (see Section 1.4.4.1, Annex 8.1, [105, EC, 1967])

Cadmium plating can be performed in acidic as well as alkaline cyanide baths. The pretreatment is the same as for zinc plating. After plating the coating is often given a passivation treatment in chromic acid. High strength steel parts are heat treated to minimise the hydrogen uptake and then activated in diluted nitrous acid before chromating. Cadmium covering layers can be chromate plated.

Electrolytes may be based on cyanide, fluoroborate, sulphate or chloride:

- electrolyte based on cyanide:
NaOH: 20 g/l; NaCN: 120 g/l; cadmium: 20 -30 g/l; temperature: 20 - 35 °C
- electrolyte based on fluoroborate:
Cadmium fluoroborate: 250 g/l; ammonium fluoroborate: 60 g/l; boric acid: 25 g/l; temperature: 20 - 35 °C
- electrolyte based on sulphate:
Cadmium sulphate: 52 - 85 g/l; sulphuric acid: 50 - 120 g; temperature: 18 - 30 °C
- electrolyte based on chloride:
Cadmium chloride: 114 g/l; ammonium chloride: 112 g/l; complexing agent (EDTA, NTA): 180 g/l

Environmental considerations

The toxic effects of cadmium are well-known. [114, Belgium, 2003], see Annex 8.1.

Discharge levels from waste water treatment plants are likely to be orders of magnitude lower than for other metals (such as zinc, see Annex 8.3). Effluent may be treated by chemical-physical treatment. The precipitation of cadmium can be improved by adding Fe^{2+} during the coagulation step, when there is a co-precipitation of cadmium and iron. It can be very difficult to obtain very low emission values for cadmium by precipitation. Additional treatment may be required, such as separate treatment at the point source prior to mixing with other effluents: e.g. electrolysis, mobile ion exchangers, evaporation [114, Belgium, 2003, 121, France, 2003].

2.5.6 Tin and alloy plating

Tin plated metal is widely used in many applications because of its unique properties. Plated tin coatings are non-toxic, ductile, resistant to corrosion, easy to coat, and have high throwing and good distribution properties. This makes it possible to plate items with complex shapes to a uniform thickness compared with hot tin dipping methods. Tin finishes are also subsequently easier to solder components onto [73, BSTSA,].

The main applications of tin are the coating of steel coil for packaging of food, beverages and aerosols, etc (see Sections 1.3.2 and 2.9.9). It is also widely used in printed circuit boards (see Section 2.11), electronic components [73, BSTSA,], appliance chassis, as well as for kitchen utensils.

Several different electrolytes are available, such as acid stannous sulphate, acid tin fluoroborate, alkaline sodium or potassium stannate and more recently the stannous systems based on organic acids, such as methane sulphonic acid, (MSA) and accounts for 13 % of European tin plate production [73, BSTSA,]. The simpler sulphate baths containing stannous sulphate, sulphuric acid and addition agents (antioxidants for stannous tin, plus grain refiner) are the most popular in rack and barrel applications because of their high current efficiency [73, BSTSA,].

Tin lead plating is the most commonly tin plated alloy. It is used as solder coat in different alloy ratios (60/40, 90/10, 95/5) traditionally using stannous, and lead fluoroborates with fluoroboric acid and additives [73, BSTSA,].

Non-fluoroboric tin lead electrolytes are now available based on the organic methane sulphonate acid. They have improved stability, low sludge formation, higher plating rates, [73, BSTSA,] better deposit properties and structure of the deposit. They are widely-used in reel- to-reel machines, as well as in barrel processing.

Tin-nickel has high throwing power, good distribution of metal, ductile, non-toxic, and is readily soldered to.

Environmental considerations

Process tanks may be equipped with fume extraction to remove aerosols generated during the electrolysis.

Effluents may be treated in typical waste water plant.

The MSA-based process is fully biodegradable, contains no chelates, complexing agents or phenols, has low COD and simple waste treatment (neutralisation and filtration) [73, BSTSA,].

Fluoroborate bath effluents should be pretreated separately to a typical waste water treatment plant.

The organic load from MSA-based processes is usually biodegradable [73, BSTSA,].

2.5.7 Precious metal plating

[3, CETS, 2002, 75, BSTSA,] Silver and gold have been deposited electrolytically since the first half of the nineteenth century. More recently, processes for the so-called platinum metals (palladium, rhodium, ruthenium and platinum) have also been developed. Thin layers of less than 1µm are used to make a wide range of items appear valuable without commensurate cost. They also provide stain and corrosion resistance. Other specific technical properties such as conductivity, hardness and wear resistance have led to their wide-spread application in the electric and electronic industries.

2.5.7.1 Silver

[73, BSTSA,] The silver plating of cutlery and hollowware is one of the oldest decorative applications of electroplating (see Chapter 1). Bright silver deposits are widely used for jewellery as well as on ornaments, trophies, giftware, etc. Due to its high conductivity and mechanical and chemical properties, silver layers are found on many components of electrical and electronic devices. Also, silver-palladium layers as a substitute for gold on electrical connectors have recently gained importance.

The majority of silver electrolytes are based on potassium-silver cyanide (potassium dicyanoargentate). A silver content of 30 – 65 g/l with free potassium cyanide of 100 – 160 g/l and potassium carbonate (15 – 20 g/l) is necessary for good plating performance. However, a potassium carbonate concentration of over 200 g/l makes it necessary to discard the electrolytes.

Attempts to replace cyanide, for example by thiosulphate and alternative complexing agents, have had limited success due to lower stability of the bath, high cost and cosmetic differences of the deposit.

Environmental considerations

The cost of silver makes recovery economic. Residues of silver may be recovered from rinse-water through electrolysis or ion exchange. Recovery of silver from spent electrolytes may be achieved through precipitation with zinc powder.

Plating tanks may be equipped with fume extraction hoods to remove cyanide fumes.

Cyanide can be readily oxidised in typical effluent treatment in waste water treatment plants.

2.5.7.2 Gold

[73, BSTSA,] Gold can be plated using rack, barrel or high speed equipment either as a very pure metal or as an alloy. It finds use in a wide range of industries such as connectors, printed circuit boards, integrated circuits, semiconductor manufacture, bathroom fittings, giftware, tableware, buttons, watches, pens, jewellery, and spectacle frames.

The majority of gold plating solutions in commercial plating facilities, whether the deposit has a decorative or a functional requirement are based on mildly acid solutions of gold potassium cyanide as potassium cyanoaurate, $\text{KAu}(\text{CN})_2$. These solutions typically contain 2 - 6 g/l of gold together with buffering agents to maintain the pH. These solutions often contain alloying metals such as cobalt, nickel, iron or indium. These harden, increase the wear resistance, and brighten the deposit. They also give distinctive colours.

A gold strike solution is often used to deposit the initial layer of gold to promote adhesion. Strike solutions usually based on gold potassium cyanide at 1 - 2 g/l but may use gold (III) potassium cyanide ($\text{KAu}(\text{CN})_4$) at a pH of around 1. These are often used on difficult to plate base materials such as stainless steel.

Alkaline solutions containing free cyanide are occasionally used for jewellery plating and for electroforming.

There are non-cyanide gold electrolytes, which are based on one of the gold sulphite complexes, which generally operate in mildly alkaline conditions, these typically contain 8 - 15g/l of gold together with organic or inorganic brightener systems.

Environmental considerations

Drag-out recovery and gold recovery with electrochemical reactions on ion exchangers from the rinse-water is economically viable.

Chelating agents resistant to degradation have been largely substituted by biodegradable ones.

Effluent treatment is similar to other electroplating rinse streams in typical waste water treatment plants.

Air emissions from potassium gold cyanide plating operations can give rise to emissions of hydrogen cyanide. The levels of emissions can be significant depending on the size of operation when considered in conjunction with emission limits contained in the revised TA Luft guidelines for air emissions regulation (inorganic gaseous substances Class II) [125, Ireland, 2003]

2.5.7.3 Palladium and alloys

Layers of palladium-nickel alloy (75 – 80 % Pd/25 – 20 % Ni) are hard, extremely ductile [73, BSTSA,] and have a white colour with good corrosion resistance. They are suitable for coating spectacle frames and writing implements.

Pure palladium deposits are also used to substitute for nickel as a diffusion barrier below a final gold flash on spectacle frames, jewellery and buttons. Sandwich layers of nickel, palladium or palladium/nickel alloy and gold flash have proven applicability on printed circuit boards and connectors as substitutes for hard gold layers.

The most common formulation is based on the complex tetraamine palladium (II) dichloride (4 - 20g Pd/l), [73, BSTSA,] containing ammonia. Alloying metals are nickel, cobalt and silver.

Environmental considerations

Besides drag-out recovery, electrolytic and ion exchange recovery of palladium are normally practical.

Tanks for ammonia-containing electrolytes may be equipped with fume extraction hoods to capture ammonia escaping from the plating electrolyte.

Effluents may be treated in typical waste water treatment plants.

2.5.7.4 Rhodium

Very thin rhodium deposits on silver have a silvery-white colour and are used to prevent staining. Their hardness and wear resistance properties are suitable for technical applications such as on reed contacts and on heavy duty connectors. Rhodium is also applied on reflectors for optical equipment and in aerospace applications.

Electrolytes are based on rhodium (III) sulphate or rhodium (III) phosphate, with a rhodium content of 2.5 – 20 g/l depending on their application for decorative (thickness of layer 0.05 - 0.5 μm) or for technical purposes (thickness of layers 0.5 - >8 μm), where selenium and sulphites are added to prevent cracking.

Environmental considerations

Besides drag-out recovery, electrolytic and ion exchange recovery of rhodium are normal practice.

Tanks for sulphuric acid-containing electrolytes may be equipped with fume extraction hoods to remove acid fumes.

Effluents may be treated in typical waste water treatment plants.

2.5.7.5 Platinum

Thin platinum layers are applied for decorative purposes, with thicker layers on electrical devices and on equipment for the chemical industry. Non-soluble platinised titanium anodes and anode baskets are in common use in electroplating.

Acid electrolytes are based on chloride, sulphate, nitrate and nitrite complexes of platinum, alkaline electrolytes on phosphate, ammonia and sodium hydroxide complexes, with metal contents of 6 – 40 g/l.

Environmental considerations

Besides drag-out recovery, electrolytic and ion exchange recovery of platinum are normal practice.

Effluents may be treated in typical waste water treatment plants.

2.5.8 Autocatalytic plating (catalytic chemically reduced coatings)

This is also known as electroless plating according to BS EN ISO 4527: 2003, [73, BSTSA,] but the term should be avoided, according to [101, CEN, 2000]. The fundamental reaction requires the presence of a catalytic metal – the metal being deposited - that allows the reaction to proceed. The advantages of the system are:

- provided there is sufficient agitation to maintain fresh undepleted solution in contact with all surfaces at all times, the deposit is uniform over the entire surface even if the shape is highly complex
- deposits are usually less porous than the same metal deposited electrolytically
- racking or fixing is greatly simplified
- non-conductors (such as plastic) are coated
- deposits often have special chemical or physical properties since the deposit is an alloy of the metal and a compound formed from the reducing agent. For example, with hypophosphite [73, BSTSA,] the deposit is an alloy of the metal and the metal phosphide, and with boron reducing agents the metal and the metal boride.

Overall environmental considerations:

Autocatalytic coatings commonly generate more waste than other plating techniques, but efficiency can vary significantly between facilities [69, NCDPPEA, 2003].

Improvement in process efficiency and a reduction in waste can be achieved by the use of electro dialysis to continuously remove the by-products from the plating solutions during operation [73, BSTSA,].

2.5.8.1 Autocatalytic nickel on metals

Autocatalytic nickel electrolytes are based on nickel sulphate and nickel chloride (nickel 2 - 10 g/l). Sodium hypophosphite (10 – 50 g/l) is the most often used reducing agent [73, BSTSA,]. Solutions also contain chelating agents (organic carboxylic acids 10 - 50 g/l) and buffers as sodium hydroxide and sodium carbonate. Cadmium may be present in some formulations as a brightener, 1 - 5 mg/l giving approximately 0.03 % in the deposit. [73, BSTSA,] Lead may be used in some formulations as an alternative up to 3mg/l. Modern formulations are available which avoid the use of both cadmium and lead, in line with the requirements of the End-of-Life Vehicles Directive [99, EC, 2000].

Autocatalytically deposited nickel-alloy layers contain 2 – 15 % phosphorus. Their key properties are:

- uniform thickness of deposit irrespective of the size and shape of items to be plated, provided that the plating solution can freely circulate around all surfaces of the components to be treated
- deposit thickness can be controlled accurately,
- surface hardness as high as electroplated finishes and within the range 350- 750 Knoop
- high resistance against wear and abrasion,
- inherent high resistance to corrosion resistance,
- good adhesion on base material,
- special properties such as natural lubricity, easily soldered to, magnetic properties.

Applications include (among many others):

- data storage devices as rigid memory discs
- components for chemical and oil and gas industry
- automotive, machine tool and electronics industries
- plastics molding tools.

Environmental considerations

See overall environmental considerations for Section 2.5.8.

Fume extraction may be required at process tanks including mist elimination to remove nickel containing aerosols.

The solution working life is short (6 - 8 MTOs, metal turnovers) due to the formation of reaction by-products. Process performance deteriorates requiring frequent discarding of used solutions. The working bath then requires disposal as a hazardous waste.

Effluents may have to be pretreated before discharge to the waste water treatment plant. Ammonia, which can complex other metals, and can be oxidised. Hypophosphite ions and phosphite ions can be oxidised to phosphates. The phosphate ion can be precipitate by adding calcium ions during the neutralisation. Metals can be separated from effluents by precipitation, plate-out or ion-exchange.

The strong chelating agent may require separate waste water treatment.

There may be trace amounts of cadmium and lead in the effluent. [124, Germany, 2003]

2.5.8.2 Autocatalytic nickel coating for plastics

Similarly to autocatalytic copper, electroless nickel solutions are used for generating a first conductive metal layer on plastic surfaces prior to further electrolytic metal (copper, nickel) deposition. [73, BSTSA,]

Plastics require etching (see Section 2.3.10.2) before deposition. Process solutions contain nickel sulphate or nickel chloride (nickel 2 - 5 g/l), reducing agents e.g. sodium hypophosphite (5 – 20 g/l), dimethylaminoborane (>10 g/l) and optionally, chelating compounds such as organic acids. Both weakly acidic (sulphuric acid at pH 3 - 6) and alkaline solutions (sodium hydroxide or ammonia hydroxide at pH 8 - 10) are in use.

An example of a process line plating on plastics (PCBs) using autocatalytic nickel [73, BSTSA,] is shown in Figure 2.7

Environmental considerations

See overall environmental considerations

Fume extraction may be used for alkaline or high temperature processes. Typical effluent treatment will remove metals except where effluents contain strong chelating agents, which may have to be treated separately.

2.5.8.3 Autocatalytic copper on metals and plastics

Autocatalytic copper plating is still a key process [73, BSTSA,] in printed circuit boards (see Section 2.11) and as well as for the metallisation of plastics. The main properties of the copper layers are uniform thickness, and fine crystalline, ductile layers with low internal stress. Copper layers are applied on small items as buttons, fashion jewellery as well as on plastic housings for electric shielding and printed circuit boards.

Plastics require etching (pretreatment, see Section 2.3) before deposition. Copper deposition starts on metal nuclei such as palladium and continues autocatalytically, thus providing an initial conductive layer. The deposition rate is 5 - 8 $\mu\text{m/h}$. The solution has a copper content of 2 – 5 g/l, with sodium hydroxide (15 – 20 g/l), chelating agents such as EDTA or similar (10 - 15 g/l) or tartrates (5 – 10 g/l) and reducing agents, e.g. formaldehyde (3 – 5 g/l).

The process solution lifetime is limited by the build-up of reaction products.

Environmental considerations

See overall environmental considerations.

Fume extraction for the process tanks may be necessary to remove gases (formaldehyde and others).

Effluent containing EDTA requires separate treatment as EDTA will prevent the precipitation of metals in the treatment process. There was an industry trend to replace EDTA as a chelating agent, although high specification work may require its use and the trend is currently being reversed [22, Fraunhofer, 2002]. Some parts of industry report the trend is being maintained [73, BSTSA,].

2.5.9 Immersion or displacement coatings – non-catalytic chemically reduced coatings

Non-catalytic chemically reduced coatings have been in use for many years, and are often known as immersion or displacement coatings. [38, Ullmann, 2002/3] They are formed when the metal to be deposited is precipitated on its reduction in solution either (i) chemically from solution, or (ii) the metallic substrate is more active than the ions in the solution in terms of the electromotive or electrochemical series, e.g.

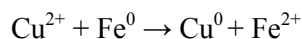

Although these deposits are often non-adherent and of poor physical quality, careful attention to solution composition and operating conditions can produce deposits that are acceptable for certain purposes. The zincate and stannate solutions used for plating aluminium are examples of special finishes producing acceptable deposits.

Printed circuit boards

High purity deposits, usually only of gold, silver and tin, are widely used on printed circuit boards. Thickness does not exceed 0.1 – 0.2 μm . [121, France, 2003] (see Section 2.11.3.2).

Mirrors

Their best known use is in producing mirrored surfaces from silver, although other techniques can now be used (such as vapour phase deposition). Their two main drawbacks are that only relatively thin coatings can be deposited and that all surfaces, including the container, receive a coating. While these solutions are sometimes used by immersion, they are now more often applied by spraying the solutions from a dual spray gun.. [38, Ullmann, 2002/3] [116, Czech Republic, 2003] The first step in silver coating of mirrors is the activation of the glass surface by stannous chloride (SnCl_2). This is followed by the application of a solution of silver nitrate (AgNO_3) and a reducing agent (usually glucose) by spraying. The precipitated silver (about 12 – 17 μm thick is rinsed by deionised water. The Ag coating is fixed by cementing copper with iron or zinc, forming a layer several μm thick: the copper is precipitated from solution by contact with the more electropositive silver deposit. This technique was discovered in 1835 and is still the best one. Some years ago a Belgian patent was given for a technique which used tin for fixation of Ag coating solution of Sn. This process is used by the largest producer of mirrors in the Czech Republic. Passivation using mercaptosilanes is also used.

The metallic layers are protected by a 50 - 70 μm of solvent-based lacquers. Replacement by water-based lacquers has so far been unsuccessful.

Figure 2.8 shows an example of a mirror processing plant.

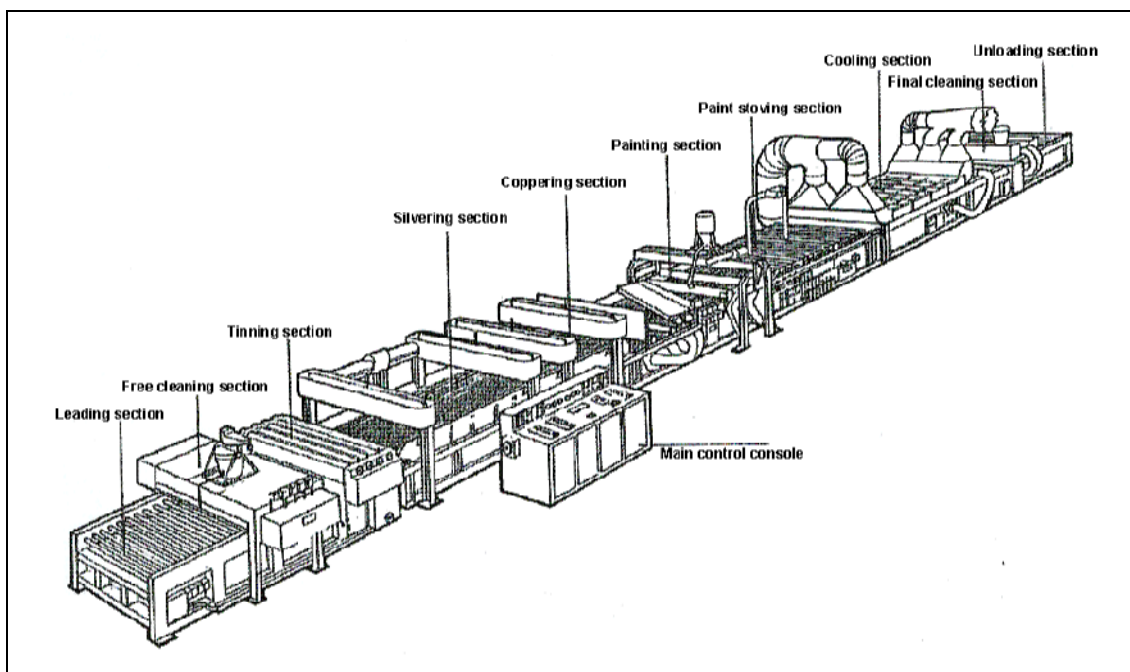

Figure 2.8: Example of mirror processing line (SVUOM, Czech Republic)

Environmental considerations

For mirrors: copper from the cementation process can form a complex in the waste waters, and is difficult to precipitate in a typical waste water treatment plant. [116, Czech-Republic, 2003]

For printed circuit boards, the environmental considerations for gold and silver are as for tin [73, BSTSA,] (see Sections 2.5.6 and 2.5.7) Tin concentrations are low, and are treated in a typical waste water treatment plant.

2.5.10 Electropainting or electrocoating

Also known as: electrophoretic painting, E-coat, Elpo, electrodeposition.

Electropainting is covered in detail in [90, EIPPCB,].

The activity is increasingly found alongside surface treatment activities covered in this document, both for subsequent painting and/or in conjunction with other coatings described here. It is used to apply a protective coating after decorative finishes (for example, applying a lacquer coat to brass plating) and as an alternative or supplement to corrosion-prevention layers, such as replacing hexavalent chromium conversion coatings on its own or used in conjunction with trivalent chromium systems, discussed in Sections 2.5.17 and 4.9.10.2. They may also reduce friction, and enable parts to be evenly or readily distributed without surface damage [124, Germany, 2003].

Common issues discussed in this document are:

- rinsing and drag-out control techniques (Sections 2.4, 4.6 and 4.7)
- solution maintenance (Section 4.11)
- water usage (Sections 2.12.2 and 4.4.5)
- electricity supply to the process and the workpieces (Sections 2.12.1.1 and 4.2.3)
- waste water treatment (Sections 2.13.1 and 4.16).

2.5.11 Lacquering

Lacquers are applied to protect and enhance decorative coatings (such as copper plating of hollowware) or to supplement corrosion protection systems such as chromating (see Section 2.5.17). They also reduce friction, and enable parts to be evenly or readily distributed without surface damage [124, Germany, 2003]. They can be applied by dipping in a proprietary water-based solution or by electropainting (see Section 2.5.10) [76, BSTSA,].

Topcoatings are applied immediately after chromate or trivalent chromium conversion coatings, by dipping in an appropriate proprietary medium or by electropainting (electrophoretic painting), see Section 2.5.10.

Environmental considerations

Effluents have no impact on typical waste water treatment plants. Rinsing waters may need to be treated separately to reduce BOD or TOC levels in the discharged effluent.

2.5.12 Oiling

See coil coating, Section 2.9.5, for electrostatic oiling.

2.5.13 Anodising

The anodising of metals is an electrolytic surface oxidation process which enhances the natural aptitude for the metal to oxidise; coatings can be 1000 times thicker than the natural layer. Aluminium is the most important material to be anodised, with alumina (Al_2O_3) formed at the surface: magnesium, titanium, tantalum and niobium are also anodised in smaller quantities [3, CETTS, 2002, 45, France, 2003] [118, ESTAL, 2003].

Aluminium is normally (90 % of cases) anodised in sulphuric acid electrolyte. For special applications, aluminium may be anodised in many different types of process solution: phosphoric acid, sulphuric/oxalic acids, sulphuric/salicylic acids and chromic acid electrolytes. [73, BSTSA,].

A wide variety of current forms and wave shapes may be used for the process, depending on the solution selected and the purpose of the anodic film. Direct current (DC), alternating current (AC), and DC with superimposed AC. are all used in various processes.

The workpiece or substrate to be treated is made anodic. During the anodising process the negatively charged anion migrates to the anode where it is discharged with a loss of one or more electrons. The metal reacts with the oxygen of the anion and a layer of oxide forms on the surface.

Figure 2.9 shows examples of decorative anodising options and Figure 2.10 shows a typical anodising line layout.

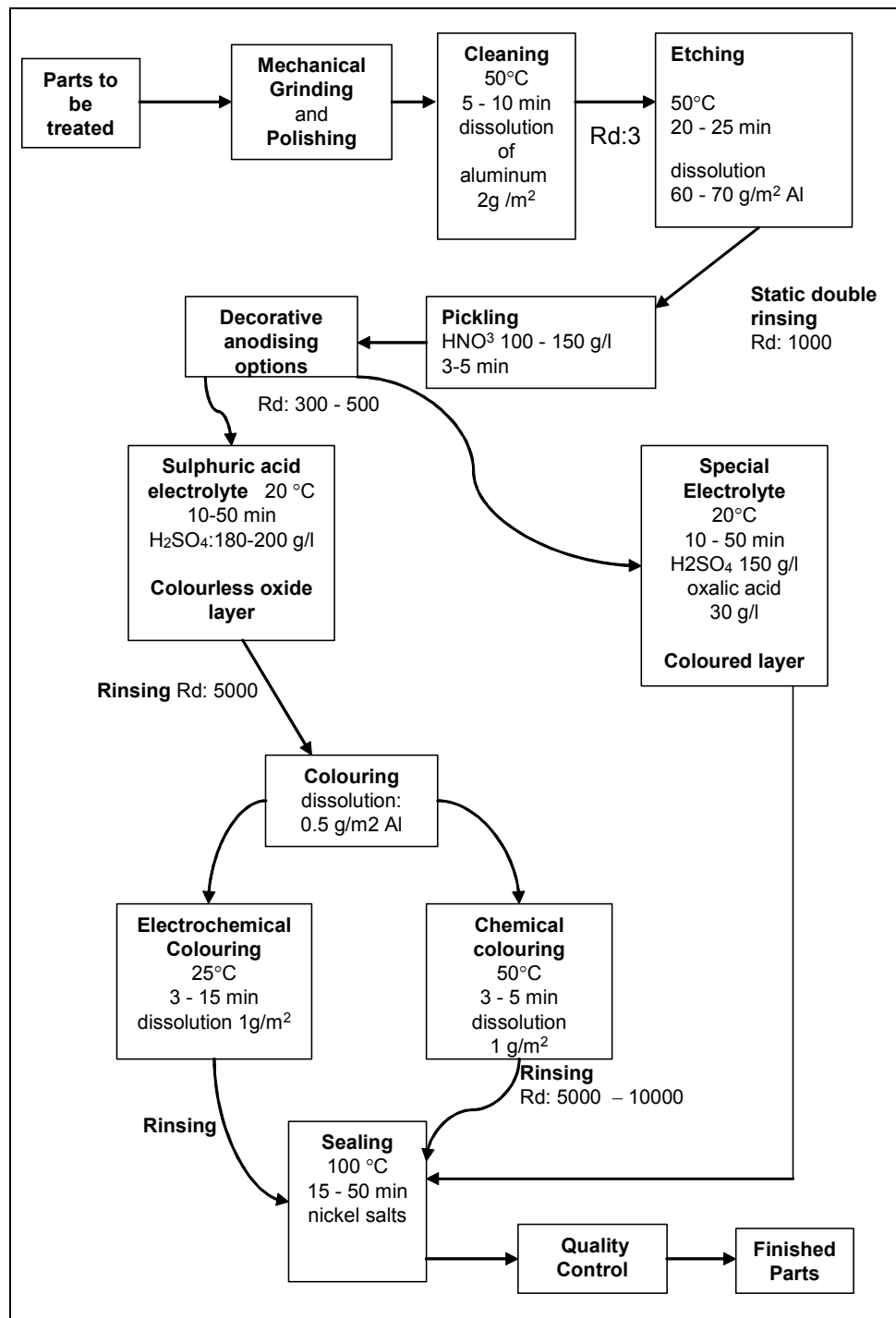

Figure 2.9: Example of decorative anodising process options [45, France, 2003] Note: Rd means rinsing ratio

The alumina coating is sealed to improve corrosion resistance and retain any surface colouring (see Section 2.5.14). Sealing is described in Section 2.5.15.

Overall environmental considerations for all anodising processes

Anodised aluminium (coloured or not) is very easily recycled for metal recovery, i.e. anodising processes have no significant effect on the recovery of aluminium metal, and other metals are not added.

Typical emission levels after typical waste water treatment are given in Section 3.3.1

2.5.13.1 Sulphuric acid anodising of aluminium

On most aluminium alloys a colourless, transparent aluminium oxide is formed, but alloys containing high quantities of elements such as iron, manganese, silicon and others [118, ESTAL, 2003] tend to give greyish or brownish coloured layers. The anodising voltage is in the range of 17–22 V and the temperature of the electrolyte is generally $20\text{ }^{\circ}\text{C} \pm 5\text{ }^{\circ}\text{C}$ and electrolyte concentration is generally $190\text{ g/l} \pm 40\text{ g/l H}_2\text{SO}_4$. A film thickness of 5–30 μm is used for decorative and protective sulphuric acid anodising. The working parameters may vary according to the application, especially in architectural anodising. Sulphuric acid anodised coatings are often coloured by special colouring processes. (See Figure 2.10). The oxide coating is sealed to obtain improved corrosion resistance (see Section 2.5.15).

In hard anodising, a film thickness of 25–250 μm is obtained. The electrolyte is operated at - below $5\text{ }^{\circ}\text{C}$ [73, BSTSA,]. Processes with oxalic acid and sulphuric acid with organic additions can also be used for hard anodising. The hard anodising layer is normally not sealed. In this state it can be impregnated with lubricants.

Environmental considerations

Acid concentrations and operating temperatures are low. If necessary, aerosols can be minimised by a layer of foam. [118, ESTAL, 2003]. However, the suppressants may be based on PFOS, which is toxic and persistent see Annex 8.2, [109, DEFRA, 2004], although alternatives to PFOS exist and are used successfully [159, TWG, 2004].

Effluent may be treated in typical waste water treatment plants.

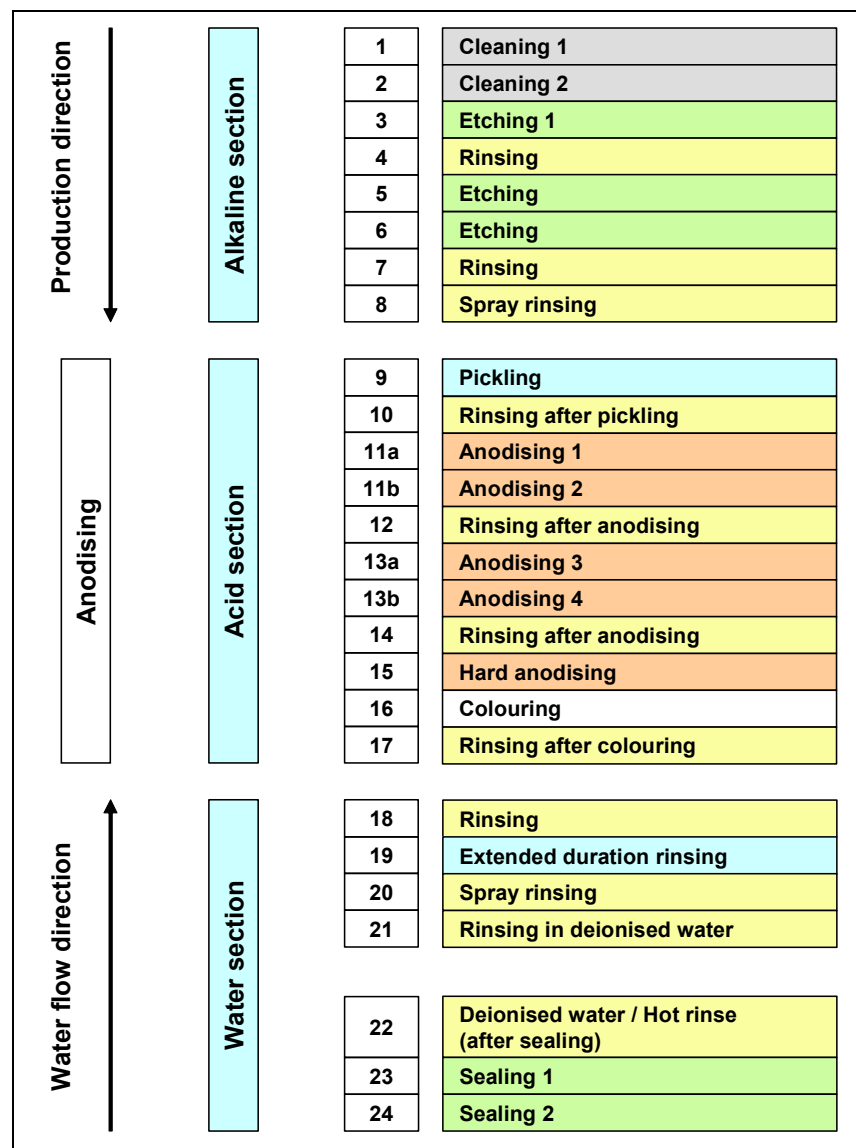

Figure 2.10: Typical anodising plant layout

2.5.13.2 Chromic acid anodising of aluminium

This forms an aluminium oxide film on most aluminium alloys ranging from a light to dark grey. The process is mainly used for aerospace and military applications. Parts can be treated after joining since residual chromic acid in the joins does not cause corrosion and the process gives very limited degradation of fatigue properties of the materials [73, BSTSA,].

The electrolyte contains 30 – 100 g of chromic acid per litre. The temperature is kept within the range of 38 - 42 °C for most aluminium alloys. The voltage cycle used depends on the alloy treated and must be closely followed to avoid etching. The coating is thin with an average of 2 - 5 µm and is relatively soft. Its corrosion resistance is good and the coating is normally not sealed.

The regeneration of anodising baths using a retardation process extends the electrolyte life by reducing its aluminium content.

Environmental considerations

Effluent may be treated in typical waste water plants.

Process tanks may be equipped with fume extraction to remove generated acid aerosols and gases. Section 1.4.4.1 includes a discussion of the health effects of chromium and Section 2.5.3 for environmental considerations for hexavalent chromium solutions. [118, ESTAL, 2003], [116, Czech-Republic, 2003]

2.5.13.3 Anodising of magnesium, titanium, tantalum and niobium

[73, BSTSA,] Anodising of magnesium gives the best protection for abrasive wear. The coatings are relatively porous and contain crystalline phases like $Mg(OH)_2$ and MgO . The oxide layer can be 25 μm or more.

Anodising of the DOW-17 type is dark grey or green and has very good adhesion. Alternating current is preferable. The coating has an attractive appearance and is well suited for being coated by for example a transparent paint. The oxide layer is soluble in the acid electrolyte meaning that the deposition rate decreases until a steady state condition is reached. Thorough rinsing is required and if the parts are not to be painted a sealing in 50 g/l $Na_2Si_4O_9$ at 93 - 100 °C for 15 minutes can be performed.

Anodising of the HAE type gives the hardest oxide and is well suited for protecting against abrasion. It has very good adhesion and gives good protection against corrosion. The coating is from light to dark brown, depending on alloy and thickness and the best properties are achieved by using alternating current. Dipping in a $Na_2Cr_2O_7/NH_4HF_2$ solution at 20 - 30 °C for 40 - 60 seconds can seal the coating.

Environmental considerations

High temperature, toxic and aggressive electrolyte (for DOW-17) require good ventilation.

2.5.13.4 Phosphoric acid anodising

Phosphoric acid anodising is being increasingly used as a preparative treatment for subsequent applications of organic or plated coatings. Phosphoric acid anodising produces a relatively thin, porous oxide that is used for bonding, painting, plating and printing applications. [132, Sheasby and Pinner, 2002].

This process has been originally developed by the aerospace industry and is presently used mainly as a pretreatment for preparing adhesively bonding aluminium structures in the aerospace industry, for painting aluminium in architectural applications and for the printing industry.

Phosphoric acid anodising produces a porous, hydration-resistant oxide and increases fracture toughness. The anodic coatings resulting from phosphoric acid anodising have a high porosity compared to those produced with other processes.

2.5.14 Colour anodising on aluminium

[118, ESTAL, 2003]

Aluminium can be coloured in many shades and colours in conjunction or after sulphuric acid anodising and is normally referred to as 'colour anodising'. Normally colouring methods are identified as 'dip dyeing', 'electrolytic dyeing' or 'two-stage colour anodising', 'self-colouring process', or 'integral colour process'. [118, ESTAL, 2003]. There are four methods [3, CETTS, 2002, 45, France, 2003].

2.5.14.1 Immersion colouring

This is the most widely used colouring method with a large range of dyes giving good light resistance. The anodised aluminium workpieces or substrate are immersed in a water-based organic or inorganic dye solution before sealing. The pores in the oxide layer adsorb the dye and then sealing is carried out to achieve durability. For colouring the oxide, thickness depends on the type of product and on the colour required. For a good corrosion protection and weather resistance, at least 15 μm minimum is needed. [118, ESTAL, 2003, Sheasby, 2002 #132].

Environmental considerations

Some organic dyes may require additional waste water treatment.

2.5.14.2 Electrolytic colouring

The anodised aluminium is placed in an acid solution containing metal salts and an alternating current (AC) is applied. This deposits oxide of the other metal which penetrates 1 - 5 μm deep into the pore of the alumina, with the residual oxide layer remaining on top. The film obtains a colour characteristic of the metal salts used. The metal salt most commonly used in Europe is tin. For special applications, nickel, cobalt and copper can be used. Tin sulphate gives shades from light bronze to black depending on the process time, of 0.5 to 15 minutes. A major use is for architectural panels. Electrolytic and immersion colouring can be combined to form new shades. [73, BSTSA,] [118, ESTAL, 2003]

Environmental considerations

The other metals used may require treatment in a waste treatment plant prior to discharge.

2.5.14.3 Interference colouring

Interference colouring is a special technique based on the electrolytic colouring principle. The appearance is produced by interference effects between two light-scattering layers: the electrochemically deposited metal layer at the bottom of pores and the aluminium oxide/aluminium interface beneath.

2.5.14.4 Integral colouring

With integral colouring, the aluminium oxide layer is coloured itself during the anodising process. Colouring occurs either by anodising in a solution of special organic acids or by normal anodising in sulphuric acid of special aluminium alloys with substances that are not oxidised such as Al-Si or Al-Fe-Mn. The oxide layer appears with a colour ranging from light bronze, through dark bronze to black, depending on the layer thickness. This technique has almost entirely been replaced by electrolytic colouring [73, BSTSA,]

2.5.15 Sealing following anodising

Sulphuric acid anodising is normally followed by a sealing process. Sealing improves the corrosion and stain resistance of the oxide layers. It also prevents organic dyes from leaching out and improves the light fastness. Sealing may be carried out in hot or cold processes. (For architectural applications see ref [138, QUALANOD, 1999, ESTAL, 2003 #118])

2.5.15.1 Hot sealing

With hot sealing, the pores in the oxide layer are closed by hydrating the aluminium oxide to boehmite: the pores are closed by the increased volume of the boehmite structure. The sealing process is carried out by dipping the anodised parts in hot or boiling (minimum 95- 96 °C) deionised water for three minutes per μm thickness. Sealing with steam achieves the same effect. [118, ESTAL, 2003, CETS, 2003 #115]

2.5.15.2 Cold sealing

Sealing methods at lower temperatures have been developed. So-called mid-temperature sealing processes are also available operating at about 60 °C. These are not based on the hydrothermal conversion of aluminium oxide for closing the pores, but by the use of nickel salts, such as the fluoride or silicate. In the past, in the European market, there was some concern about long term-properties such as light fastness and corrosion resistance. However, such processes have now been proven and accredited for outside use (see Qualanod [138, QUALANOD, 1999, ESTAL, 2003 #118])

There are also processes working at 25 - 35 °C. Advantages with cold processes are lower energy consumption and shorter process times [73, BSTSA,].

Environmental considerations

Hot sealing may also require ventilation and have very high energy consumption. However, this can be reduced by covering the tanks or with proper insulation [159, TWG, 2004]. There is lower energy consumption with cold sealing [73, BSTSA,].

2.5.16 Phosphating layer conversion coatings

[38, Ullmann, 2002/3, 71, BSTSA,] Phosphate coatings are the most widely used conversion coatings and probably the most widely used surface treatment. They are used to treat steel, aluminium and zinc for:

- cold forming: this involves very high surface stresses and phosphating is used in all types of cold forming operations, i.e. drawing of wire, tube, or profile; deep drawing; cold heading, cold extrusion, cold forging. These applications are described in the reference [86, EIPPCB,]
- coil coating: steel strip electroplated with zinc is phosphated in the process line to improve formability in subsequent drawing operations, such as steel can forming, as well as for corrosion resistance and subsequent paintability, see Sections 2.9.6 and 2.9.8.9. Hot dip galvanised steel strip is discussed in [86, EIPPCB,]
- rustproofing: heavy zinc and manganese phosphate coatings retain a protective oil film and provide substantial corrosion prevention, e.g. for nuts, screws, bolts, and tubes
- bearing surface lubrication: manganese phosphate improves the retention of lubricant and shortens running-in periods. It is used for pinions, camshafts, pistons, gears, and valves
- paint base: phosphating enhances the adhesion and corrosion protection of paints, see [90, EIPPCB,]
- electrical insulation: phosphate layers can be used to coat the silicon steel sheets forming the cores of electric motors, generators or transformers. A phosphate coating of 1 - 6 μm thickness is sufficient insulation to prevent eddy currents.

There is a wide variety of phosphating processes, but the most important are alkali (iron) and zinc phosphating. The surface weight of layers is 0.05 – 5 g/m^2 .

Methods of application

The phosphating solutions are generally applied by spraying or by immersion depending on the number, size, and shape of the parts to be treated. The type of application may lead to differences in the composition and morphology of phosphate coatings. Coiled strip is also coated by the roll-on, dry-in-place process, in which phosphating solution is applied to the strip and, without rinsing, is dried to form the phosphate coating, see Section 2.9.6.

Phosphating requires workpieces or substrates to be degreased and pickled see Section 2.3. [116, Czech-Republic, 2003] Activation prior to phosphating may be with hot water or with special proprietary titanium or manganese phosphate dispersions to induce the formation of a fine-grain phosphate coating in the subsequent step. Final rinsing may be with deionised water or passivating chemicals based such as Cr(VI) and Cr(III) compounds. Rinsing with water is needed between the processing stages as described in Section 2.4.

Overall environmental considerations for all phosphating processes

Effluents may require pH control and may [124, Germany, 2003] contain nickel, manganese, as well as zinc (according to solution make-up), which can be dealt with in a typical waste water treatment plant. Anions that may be of concern include nitrite and fluoride, which may require additional treatment.

Sludges formed in the process solutions require removing as wastes as part of the solution maintenance.

Health and environmental concerns have instigated the development of:

- nitrite-free processes with hydroxylamine, nitroguanidine, or hydrogen peroxide as accelerators
- nickel-free processes
- chromium-free after-rinses based on organotitanium, inorganic zirconium, or polymeric compounds
- effluent-free phosphating lines using ultrafiltration for cleaning, hydrogen peroxide acceleration in phosphating, and precipitation plus ion exchange for chromium-free after-rinses, without compromising the performance of the subsequently painted parts.

2.5.16.1 Alkali phosphating

This is mainly used when corrosion protection does not have to satisfy stringent requirements. For steel substrates, the solutions (pH 4 - 6) consist of acid alkali phosphates, free phosphoric acid, and small amounts of additives; oxidising agents (e.g. chlorates, chromates, or nitrites), condensed phosphates (e.g. pyrophosphate or tripolyphosphate), and special activators (e.g. fluorides or molybdates). The first reaction is the pickling reaction which produces Fe^{2+} ions from the substrate (steel). These ions react with phosphate ions from the solution to form sparingly soluble iron phosphate that precipitates and adheres strongly to the metal surface. Iron phosphating processes may not require acceleration. The coating weight varies with the bath composition. Coatings formed on ferrous surfaces contain iron oxides and phosphates. Iron phosphating solutions normally contain surfactants for cleaning and oily surfaces may thus be treated in one step (so-called 'cleaner-coater').

On zinc surfaces, zinc phosphate layers are formed in an analogous reaction sequence. Aluminium is usually treated with solutions containing fluoride; thin, complex coatings are formed that contain aluminium, phosphate, and fluoride. The baths are adjusted to a concentration of 2 – 15 g/l. Treatment may be by spraying, flooding, or dipping. The bath temperature is normally 40 - 70 °C, but can be lowered to 25 - 35 °C with special bath compositions. Treatment times are 5 - 10 seconds (spraying of strip material) and 1 - 3 minutes (spraying or dipping of individual parts). Iron phosphating includes both thin-coating

(0.2 - 0.4 g/m²) and thick-coating methods (0.6 - 1.0 g/m²). The colour of the layers is blue-green, but may be reddish iridescent. The surfaces become more matt and grey with increasing coating weight.

2.5.16.2 Zinc phosphating

Zinc phosphating is primarily used for the surface treatment of steel and zinc (or zinc coatings on steel) as well as composites of these metals with aluminium. Application may be by spraying or immersion. Essential constituents are zinc, phosphate ions, and an oxidizing agent, often sodium nitrite. The pH value is between 2 and 3.5. Concentrations vary considerably; additives such as nitrate, fluoride, silicofluoride, nickel ions, or manganese ions are common.

The following is an example of a process suitable for the phosphating of steel sheets as a pretreatment prior to painting:

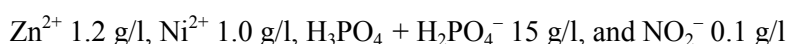

A pH of 3.2 is achieved with sodium hydroxide. The process is usually carried out at up to 95 °C. For cold forming applications total concentrations may well be ten times higher.

Typically, the phosphating reaction may be broken down into five steps:

Pickling reaction

Part of the metal surface is dissolved by the acid:

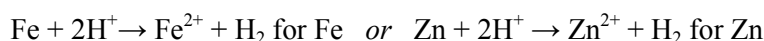

The phosphating of aluminium requires fluoride ions to attack surface oxides which only slowly dissolve in phosphoric or nitric acid:

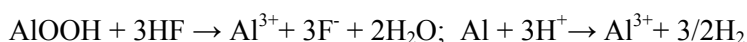

Acceleration

The pickling reaction is accelerated by oxidising agents called accelerators, which also prevent the evolution of excessive amounts of molecular hydrogen thus minimising hydrogen embrittlement: [159, TWG, 2004]



Complexation

When coating aluminium, sufficient fluoride ions must be available for complexation of surplus Al³⁺ ions as, in concentrations as low as 3 mg/l, they prevent the formation of zinc phosphate coatings. If different metals including aluminium are to be treated, the use of fluoride-free phosphating solutions may allow phosphating of steel or zinc without coating the aluminium:

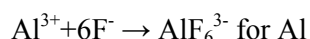

Coating formation

Metal dissolution in the pickling reaction results in a significant increase of the pH value close to the metal surface. Consequently, the equilibrium constant for the precipitation reaction is exceeded and zinc phosphate is precipitated as the metal surface offers favourable nucleation sites. Once the whole metal surface is covered, the reaction ceases:

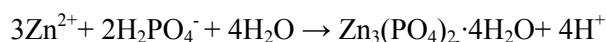

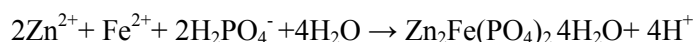

Sludge formation

Dissolved iron and AlF_6^{3-} ions from the pickling reaction do not accumulate in the phosphating solution but are precipitated as iron(III) phosphate or trisodium hexafluoroaluminate, respectively. When treating galvanised surfaces and in spraying processes, relatively small amounts of tertiary zinc phosphate sludge are formed as well. Nitrate-accelerated processes often do not involve sludge formation. Iron(II) nitrate accumulates until equilibrium is reached between iron dissolution and drag-out.

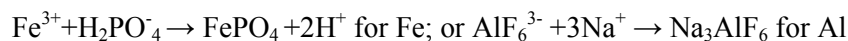

The sludges formed must be removed either periodically or continuously.

Pre-paint processes

Zinc phosphating processes carried out prior to painting can be classified as high zinc or low zinc processes. High zinc processes operate at 3 - 4 g/l Zn^{2+} and low zinc processes at 0.7 - 1.5 g/l Zn^{2+} , the upper limit for dip applications. Low zinc concentration, i.e. high phosphate to zinc ratio, improves corrosion protection. Coatings on steel produced by low zinc processes consist mainly of phosphosphyllite and show superior paint-base performance to the high zinc processes with their hopeite coatings, such as stone chipping resistance and wet adhesion on galvanised substrates. Performance has further increased with the introduction of trication processes, which contain zinc, nickel, and manganese both in solution and in the coating. These processes have become commonplace in, for example, the automotive industries. [38, Ullmann, 2002/3]

For powder coatings, iron phosphate often gives optimum results [90, EIPPCB,].

Low temperature processes for cold forming

These are accelerated by nitrate, and the iron(III) concentration in the bath is limited to 5 - 8 g/l by oxidation with air, preferably continuously in a separate reaction tank. The operating temperature has thus been lowered by about 30 °C to 50 - 60 °C, and the phosphating tank remains virtually free of sludge.

2.5.16.3 Manganese phosphating

This is performed by dipping only, and iron(II) nitrate is often used for acceleration.

2.5.17 Chromium conversion coatings

[3, CETS, 2002, 104, UBA, 2003]

Chromium conversion coatings are used to enhance corrosion protection on various metal surfaces, including electroplated zinc and cadmium, zinc die castings, tin, aluminium, magnesium and magnesium alloys, copper, brass and bronze, nickel, silver and stainless steel. Without such protection, zinc electroplated steel surfaces have a strong tendency to white (zinc oxide) corrosion. Often referred to as 'chromating' because the process originally used only hexavalent chromium as the chromate ion ($\text{Cr}_2\text{O}_4^{2-}$), it is used in nearly all areas of the steel processing industry and is an essential post treatment step in zinc plating. The wide spread use of the original yellow chromating was increased by the development of further layer systems of blue and black chromating, which have decorative effects in addition to corrosion protection.

Phospho-chromating exists with both hexavalent chromium (Cr(VI)) and trivalent chromium (Cr(III)) versions and is used in the treatment of aluminium prior to painting [118, ESTAL, 2003].

The layer thicknesses of the chromating coats lie between 0.1 and 2 μm . They are well suited as adhesion mediators for subsequent treatment with paint layers or synthetic material coatings. Lubricants can be included in order to decrease the friction values of treated pieces.

The corrosion protection of the chromium coatings can be increased by further sealing layers, described in topcoatings, Section 2.5.17.7.

The typical composition of solutions are chromic acid, dichromate, chloride, fluorides, sulphates, borates, nitrates and acetates, which are used in different combinations and concentrations to produce different colours and layer characteristics.

Overall environmental and health considerations

For health issues relating for Cr(VI), see Section 1.4.4.1.

For Cr(VI) aerosols and effluents, see Section 2.5.3.

2.5.17.1 Chromium (VI) conversion coatings

Conventional processes are all based on the use of acid oxidising solutions, the oxidant being hexavalent chromium (Cr(VI)). The protection mechanism is based on the dissolution of the Cr(VI) present at the surface of the film. The presence of chromate works locally to inhibit any corrosive action on the exposed metal surface.

2.5.17.2 Chromium (VI) conversion coatings on electroplated zinc layers

Coatings are applied by chemical reaction in aqueous solutions. Numerous proprietary conversion coating processes are available, producing decorative and protective films with colours ranging from clear through iridescent yellow to brass, brown, olive drab and black. Broadly, the deeper the colour the better the corrosion resistance.

2.5.17.3 Chromium (VI) conversion coatings on copper, brass and bronze

Chromate solutions to treat copper and copper alloys are prepared with proprietary materials. The treatment not only passivates the surface but also provides effective chemical surface polishing. Consequently, chromate treatments on copper and copper alloys are used both as a final finish and as a whole or partial substitute for mechanical buffing prior to nickel or chromium plating. The passivity obtained is effective in reducing corrosion and sulphide tarnishing.

Environmental considerations

Chromate bright dipping solutions are preferred because of their non-fuming nature.

Increased effluent treatment may be required because of the dissolution of copper in the process bath.

2.5.17.4 Chromium (VI) conversion coatings on aluminium

Chromate or phospho-chromate conversion films, ranging from clear yellow for chromate to green for phospho-chromate [118, ESTAL, 2003] can be produced on aluminium. The film colour depends on the immersion time, pH, solution concentration and, to some extent, on the composition of the alloy to be treated. The main use is as a pretreatment prior to painting or powder coating, although it is used for components in aerospace, electronics and other applications [118, ESTAL, 2003, CETS, 2003 #115].

The ability of the treatment to provide corrosion resistance without a corresponding loss of conductivity is particularly useful for electronic applications.

Solutions containing low Cr(VI) are available (Personal communication, ESTAL).

Environmental considerations

Low Cr(VI) solution reduce drag-out and typical waste water treatment requirements.

2.5.17.5 Chromium (VI) conversion coatings on magnesium and its alloys

Because of their corrosion characteristics, chromate treatment is still the only common method to treat magnesium and magnesium alloys. This treatment is often applied at the raw material source, in order to ensure good storage characteristics. Chromate treatment is also used to prepare magnesium and magnesium alloys for subsequent plating, particularly for nickel autocatalytic plating.

There are two typical process methods in use:

- pickling is mainly used to protect parts during storage and shipment
- dichromate treatment provides maximum corrosion protection and improved adhesion properties for paint.

2.5.17.6 Trivalent chromium (Cr(III)) conversion coatings on aluminium and electroplated zinc

Trivalent chromium (Cr(III)) conversion coating processes were first developed about 20 years ago as a more environmentally acceptable alternative to hexavalent chromium (Cr(VI)) processes, mainly on electroplated zinc. These conversion coating systems and treatment baths do not contain hexavalent chromium and therefore avoid the environmental or health problems associated with hexavalent chromium. [118, ESTAL, 2003]

Trivalent chromium-based blue coating processes can produce the appearance traditionally associated with hexavalent processes over acid, cyanide or alkaline non-cyanide zinc plating systems.

Trivalent chromium conversion coating processes usually produce clear or blue conversion coatings only. Recently, trivalent chromium passivates producing a higher film thickness and greater corrosion resistance have been developed that perform well in comparison with iridescent hexavalent chromium passivation.

At least one process is available with coatings that are Cr(VI)-free. They have a unique light green, yellow iridescent colour and provides up to 120 hours to first white corrosion when barrel processing and up to 240 hours when rack processing. These numbers vary depending on the process and if a topcoat or sealer has been added. This passivation can be used on all zinc plating (acid, alkali non-cyanide and cyanide) as well as zinc alloys (Zn-iron, Zn-cobalt and Zn-Nickel). It is claimed that treated parts can be baked at 200 °C for four hours and still retain up to 90 % of their corrosion protection abilities.

Black Cr(VI)-free passivations have also been developed which, with sealers, give the comparable corrosion test results [124, Germany, 2003].

However, the thickest conversion coatings, olive drab, that give greater corrosion protection for zinc can only be achieved using hexavalent chromium conversion coating processes.

Compared to hexavalent chromium conversion coating processes, the trivalent chromium conversion coating:

- can provide equal or more corrosion-resistant for the same colour finish [124, Germany, 2003]
- does not require a running in period for freshly prepared passivation solutions
- the colour and performance of the processes are more uniform throughout the solution life
- solution is normally at least twice that of conventional hexavalent chromium and limited by impurities rather than consumption of the active chromium compounds, resulting in less solution disposal
- cannot produce the range of colours and corrosion resistance given by hexavalent coatings
- requires more process control
- may require a top coating or sealer to produce similar corrosion performance to darker Cr(VI) passivations.

Environmental considerations

There are no specific health and safety considerations for Cr(III).

Reduction of Cr(VI) to Cr(III) is not required during waste water treatment.

Cr(III) processes generally contain approximately ten times the concentration of chromium to Cr(VI) baths. The zinc removal from zinc plating is twice that of Cr(VI). Cr(III) may therefore generate more waste in waste water treatment [113, Austria, 2003].

Cr(III) processes with a similar corrosion resistance to Cr(VI) processes are usually heated baths with a higher energy consumption than the corresponding Cr(VI) processes [73, BSTSA,].

2.5.17.7 Topcoatings for chromate conversion coatings

Both hexavalent and trivalent chromate conversion films are porous and adsorbent in nature and their thickness is very limited. Their protective action can be enhanced by applying a subsequent top coating film, either organic (e.g. methacrylate, see electropainting, Section 2.5.10 and lacquering, Section 2.5.11) or inorganic (e.g. metasilicate) and/or mixed inorganic-organic. These topcoatings have additional functions: a self-healing effect, providing protection against local mechanical scratches due to improper handling during processing; a substantial reduction in the quantity of Cr(III) leaching out from the treated surface, and a reduction in friction parameters [124, Germany, 2003]. Top coating protection is mainly due to the physical barrier of the coating itself.

2.5.18 Metal colouring

[3, CETS, 2002] It is possible to obtain a wide range of shades and colours over different metals by heat treatment, chemical dip or electrolytic treatment. These processes are used for brass, copper and steel parts. The most commonly used system is chemical dipping. The results obtained will depend more on the practice of the operation and process parameters than on the formula used. Originally, sulphide and polysulphide solutions in alkaline media using sodium, ammonium or barium salts from room to high temperatures were used. It is now more usual to use solutions containing metallic ions (copper, selenium, molybdenum, etc.) in an acid medium and at room temperature.

Small articles may be coloured in bulk, then proud surface areas relieved by tumbling with an abrasive media, see Section 2.3. All sulphide treated workpieces require wet or dry scratch-brushing and must be protected by a topcoat of clear lacquer.

Environmental considerations

Depending on the precise formulations used, effluents may need to be pretreated separately prior to typical waste water treatment.

2.5.19 Bright dipping

For all substrates including aluminium, this term is synonymous with ‘brightening’ and ‘chemical polishing’, see Section 2.5.21 [118, ESTAL, 2003, 159, TWG, 2004].

2.5.20 Chemical blacking – oxide coatings

Immersion-type chemical oxidation coatings are used mainly for appearance, as a paint base, or for their oil-retention characteristics. [38, Ullmann, 2002/3]

Environmental considerations for all chemical blacking processes

Fumes from processes containing alkali and chromium may require extraction and possibly scrubbing. Scrubber effluents may require treatment in a waste water plant.

Rinsing waters may require treatment for pH. Other materials such as nitrogen-containing compounds, other oxidising agents and sulphides may require additional treatments to those found in a typical waste water treatment plant.

Steel

Steel may be blackened in a high temperature bath containing 480 – 840 g/l of a mixture of about 75 wt % sodium hydroxide and 25 wt % sodium nitrate. The solution is operated at the boil between 121 – 149 °C. Instead of 25 wt % sodium nitrate, a mixture of 12 wt % sodium nitrate and 13 wt % sodium nitrite may also be used.

Lower boiling points are obtained by including various additives containing sulphur. The resulting oxide coating is somewhat less corrosion-resistant because of the inclusion of iron sulphide in the film. Some of the sulphide-modified materials may also be used to blacken stainless steel.

Following thorough rinsing, the oxide film is normally coated with an oil, wax, or lacquer.

Stainless steel

Stainless steel can also be blackened in molten sodium/potassium dichromate at about 370 °C provided the parts are not adversely affected by the high temperature. The resulting oxide has good corrosion resistance, and the procedure is covered by military specifications.

The ‘Inox’ process, dipping in chromic acid and sulphate at 60 – 90 °C can be used, and chromium-nickel steel can be coloured black by dipping in NaOH/NaNO₂ at 125 - 130 °C [113, Austria, 2003].

Copper

Copper may be blackened in a bath containing 120 g/l of a mixture of 75 wt % sodium hydroxide and 25 wt % sodium chlorite at 93 – 100 °C. The black copper (II) oxide produced has a fuzzy appearance. On bright finished parts, this fuzzy nap disappears when lacquer is applied, restoring the lustrous appearance, or it may be laid down (not removed) by gentle buffing or tumbling in sawdust or other soft abrasives (see Section 2.3).

Brass

Brass may be blackened in the same solution but may not respond, depending on the zinc content and metallurgical history. Activation may be carried out by immersion in a bath containing 120 g/l of a mixture of 85 wt-% sodium hydroxide and 15 wt-% sodium chlorite operated at 93 - 100 °C for 5 - 10 min to dezincify the surface, after which the blackening bath will usually function normally.

Aluminium

Aluminium may be given an oxide coating by immersion by a number of different processes including the Alzac and Juratka processes. Electrolytic processes (anodising) are generally preferred.

2.5.21 Brightening

In the brightening of steel, concentrated nitric acid is used to form a very clean surface. Note that this process forms nitrous gases in the exhaust gas. [104, UBA, 2003]

Copper and brass are brightened by oxidising a surface layer.

Aluminium and some of its alloys can be brightened by chemical or electrochemical processes for special applications such as lighting and decorative finishes [118, ESTAL, 2003, 132, Sheasby and Pinner, 2002].

Phosphoric acid pickles have specific uses such as chassis parts and bicycle frames. It is usually used at a concentration of 10 - 15 %, at temperatures of 40 - 50 °C and sometimes as high as 80 °C.

Metal surfaces must be degreased thoroughly. Poor results, such as uneven attack or stained surfaces after brightening, are frequently due to insufficient pre-degreasing.

Environmental considerations

Spent brightening solutions may require treatment for low pH and possibly metal content prior to disposal as effluent. Alternatively, they may be disposed of as liquid wastes.

Acid fumes, particularly those containing NO_x may require extraction, possibly with treatment.

2.5.22 Etching – Alkaline etching of aluminium

The most frequently used method for etching aluminium is aqueous solutions of caustic soda, with or without other additives. It can be used for general cleaning purposes where oxide, grease or subsurface detritus may be removed. With more prolonged etching, it can produce stain or matt finish for nameplates or decorative architectural work; or for deep engraving and chemical milling. It is a relatively cheap and easy method of etching but the details can be exceedingly complex.

Solutions for decorative etching may contain from 4 - 10 % or more caustic soda, used at 40 - 90 °C, possibly with a wetting agent to disperse grease and give a light foam blanket.

The most common are 'long-term use' etch processes operated on a never-dump basis. These processes contain special additives, which stabilize the aluminate solution. Etch rate must be controlled to get a constant etch finish. Important parameters are: temperature, free sodium hydroxide, aluminium and additive content.

Alkaline etches with increased etch rates are used to remove the anodised film from aluminium jigs before the next jiggling.

[118, ESTAL, 2003, 132, Sheasby and Pinner, 2002, 138, QUALANOD, 1999].

Environmental considerations

Spent alkali etch baths may be re-used in municipal waste water treatment [159, TWG, 2004].

2.5.23 Chemical milling

[47, France, 2003] Chemical milling is a process used to remove metal on workpieces by dissolution in a caustic or acid bath without an external source of energy (mechanical or electrical). Metal is removed off the whole surface of the part dipped in the milling bath provided this surface is in contact with the solution. Areas to remain are masked. The speed of the chemical dissolution is low, processing 0.5 to 3 mm/h compared with mechanical processes. The thickness removed is almost constant all over the surface, but with a roughness created which varies with the process used.

The most important uses are on aluminium alloys for the aeronautical and aerospace industry. It is generally used on sheets that have been previously curved and where it is necessary to save weight. Chemical milling can also be used on titanium alloys, stainless steel and some special alloys with a nickel, cobalt or magnesium base.

Process chemistries used are:

- for aluminium: caustic soda with additives (sodium gluconate, sodium sulphide)
- for titanium: hydrofluoric acid (20 – 50 g/l) with nitric acid (50 – 70 g/l)
- for stainless steel: hydrochloric acid with nitric and phosphoric acid.

The main control parameters for aluminium and aluminium alloys are:

- concentration of the bath: from 100 to 150 g/l of free NaOH
- temperature: 80 °C for older processes, types up to 110 °C for high speed processes
- concentration of dissolved metals: 70 to 90 g/l Al
- composition of the alloy chemically milled.

All these parameters affect the speed of processing, the thickness regularity and roughness of the finish.

Generally, the entire surface is not milled. In order to prevent milling on some areas it is necessary to mask those areas with protecting layers such as neoprene. The usual technique is to mask the whole part and then remove the mask from the areas to be milled. The mask is cut by scalpel or laser beam.

A typical process sequence is:

- solvent degreasing
- alkaline etching
- rinsing
- pickling (e.g. sulphochromic pickling)
- rinsing
- drying
- masking
- removal of mask on surface to be treated
- attack
- rinsing
- surface passivation: (e.g. sulphochromic or nitric acid)
- rinsing
- removal of mask
- quality control.

Environmental issues

The main problem for this treatment is the large quantity of sludge due to the dissolved metals. The concentration of the chemical milling bath is generally kept below 70 g/l of aluminium and so used solutions are discarded beyond this concentration. Normal waste water treatment may be used and the principle component of the sludge is NaAlO_2 .

2.6 After treatment activities

2.6.1 Drying using hot water

[3, CETS, 2002] After all wet processing operations have been completed, the workpieces or substrates need to be quickly and effectively dried in order to avoid staining and corrosion. The simplest method of drying is by immersing the components in hot water for a few seconds and then allowing them to dry-off in the air.

The disadvantage of hot water drying is the high energy loss from the tank surface. It is, however, common practice in surface treatment shops moving jigs manually (and hence low throughput of workpieces).

The water temperature needs to be carefully controlled. The temperature must be limited to 60 °C for plated plastic components in order to avoid deformation. Zinc plated and passivated components also are limited to 60 °C to avoid dehydration of the coating and loss of corrosion protection of the passivate film. Chrome plated components can be dried at up to 90 °C. Deionised water is usually used to prevent drying stains. Some plants use a continuous trickle feed of deionised water, the water overflow is then used to provide a feed for a preceding cascade rinsing system. The hot water stage may also be a final rinsing step.

Environmental considerations

Energy efficiency can be low.

2.6.2 Drying using hot air

Drying in automated jig plants is most easily accomplished on automatic lines using hot air. The jigs are placed in a tank-shaped drier at the end of the process line; the tank has the same dimensions as the vats in the line to fit into the transporter system. Hot air is evenly re-circulated from the top to the bottom of the tank at temperatures of 60 – 80 °C. Hot air escaping from the top of the drier tank makes the equipment thermally inefficient.

In some cases, such as the new thick film passivations or to reduce drying times, it is necessary to heat the substrate or workpieces to 80 °C and higher. The temperature of the air circulating in the tank-shaped driers then needs to be above 100 °C. The air is normally heated by circulation or heat-exchangers using steam or hot oil. Direct heating systems are an alternative, using a special gas burner with an open gas flame in the circulating air. The burning gas heats the air directly with an efficiency of nearly 100 % of the energy input [124, Germany, 2003].

Environmental considerations

There is a potential for poor energy efficiency if air is not retained and recirculated effectively.

2.6.3 Drying using air knives

There is a growing use of localised air drying by means of precision nozzles or 'air knives' that is more energy efficient than hot air tank drying. See Section 2.3 for a description.

2.6.4 Heat treatment for hydrogen de-embrittlement

Heat treatment to avoid the hydrogen embrittlement formed in pickling, cathodic cleaning, and the electrodeposition of metal where the current efficiency is less than 100 %, or in chemical deposition (phosphating). The temperature and time of the de-embrittlement process depend on the substrate [159, TWG, 2004].

Environmental considerations

Energy consumption [124, Germany, 2003].

2.7 Common techniques for water and waste water treatment, process solution maintenance and materials recovery

There are a number of techniques that are used for treating water and water-based solutions, and are widely used in the surface treatment of metals for:

- treating incoming water supplies
- treating waste waters prior to discharge or for re-use
- process solution maintenance
- in-process materials recovery. This may also serve as process solution maintenance

The basic techniques only vary slightly according (e.g. choice of resins for ion exchange) to the application, they are briefly described here and more fully in Chapter 4. They are well described elsewhere, and some are especially useful when considering closing the loop for process materials, see Section 4.7 [162, USEPA, 2000].

2.7.1 Filtration

There are many types of filtration. On the smaller scale they start with cellulose (paper) sheets usually clamped in filters (sometimes layered with activated carbon or other absorbents), and cartridges. On a larger scale, sand filters are used for cleaning raw water or polishing effluents, and belt filters or filters presses are used with higher solids applications such as waste water sludges, often in conjunction with coagulants.

Environmental considerations

Pumps (with an associated energy demand) are usually require for filtering, although in some cases (such as some sand filters) gravity is sufficient.

The filter medium, with the filtrate is usually disposed of as a waste.

2.7.2 Adsorption techniques

Activated carbon is used to adsorb unwanted organic substances formed from breakdown products in a solution. It can be added to the solution on batch basis and then filtered out, or it can be used in a layered filter system.

Granulated polypropylene felt or other lipophilic filter media can be placed in filter housings and used for removal of oils by adsorption.

Polymer filtration uses chelating, water soluble polymers to selectively bind target metals in aqueous streams.

Environmental considerations

Activated carbon will also remove a portion of the useful organic chemical additives, such as brighteners and these will need replenishing.

The absorbent material along, with the retentate and filter medium, is usually disposed of as a waste, although precious metals may be recovered.

2.7.3 Crystallisation

Various evaporation and cooling systems are used to bring solutions to a super-saturation point where solid crystals form and can be separated from solution.

Environmental considerations

Energy requirements for heating or cooling

2.7.4 Atmospheric evaporation

Atmospheric evaporation occurs when solutions are heated. As a basic technique, it reduces the volume of process solutions and allows drag-out to be returned or fresh chemicals to be added to the process solution. It can be increased by using air agitation and/or using an evaporator. The evaporator may be filled with a packing material to increase the air-to-water evaporation surface. Evaporators are often used with a condenser to recover distilled water.

Environmental considerations

Evaporators can often beneficially use the heat from the solution when the process is self-heating, e.g. from the electrical current passed. The heat lost then assists with cooling the solution.

2.7.5 Vacuum evaporation

Reduced pressure and elevated temperature combine to separate constituents with relatively high volatility from constituents with lower volatility, e.g. removal of water from an acid plating solution. Evaporating the process solution (e.g., acid distillation) from contaminant phases with higher volatility can also purify process solutions. Multiple stages may be used to increase separation purity, to reduce energy requirements, or to accomplish multiple phase separations.

Environmental considerations

Energy requirements for heating and evacuation to vacuum conditions.

2.7.6 Electrolysis – plating out

Transition metals can be removed from waste water streams by plating out on high surface area electrodes in metal recovery cells. It can also be used in combination with ion exchange as a means to concentrate metal ions, see Section 2.7.8.

Environmental considerations

At concentrations below about 10 mg/l the metal deposition becomes very inefficient with 10 to 100 times the theoretical energy requirement actually needed for metal deposition.

2.7.7 Electrolysis – oxidation

It is possible to oxidise both unwanted organic by-products and metals in solutions, such as Cr(III) to Cr(VI). This can be done with or without a ceramic membrane, depending on current density conditions.

2.7.8 Ion exchange – resin

Ions in solution are selectively removed by exchanging positions with resin-functional groups. The direct ion exchange treatment of waste water provides a means of concentrating multivalent cations for subsequent treatment on column regeneration or by plating out (see Section 2.7.6) [3, CETS, 2002], [159, TWG, 2004].

Environmental considerations

Ion exchange requires energy for pumping during use and regeneration, and also requires extensive chemical dosing; the chemical requirement for metal ion capture is generally three to four times the theoretical requirement.

2.7.9 Electrodeionisation

Ions are removed using conventional ion exchange resins. An electric current is used to continuously regenerate the resin, instead of regeneration chemicals.

2.7.10 Acid (resin) sorption

Acid (resin) sorption is configured similarly to ion exchange. Resins are designed to selectively adsorb mineral acids while excluding metal salts (adsorption phase). Purified acid is recovered for re-use when the resin is regenerated with water (desorption phase).

2.7.11 Ion exchange – liquid/liquid

Ionic contaminants are removed from process solutions into immiscible primary liquid extraction solutions. Secondary liquid extraction solutions are used to remove the contaminants and to regenerate the primary extraction solution.

So far, the only application is ammoniacal etch solutions that are regenerated by removal and recovery of copper, with a closed loop extraction solution system.

2.7.12 Membrane filtration

There are various types of membrane filtration and their use depends on their pore size. These systems are pressurised because of the small pore size.

- microfiltration (MF) is a membrane filtration technology that uses low applied pressures with pore sizes in the range of 0.02 to 10 microns to separate relatively large particles in the macromolecular to micro particle size range (approximate molecular weights >100000)
- ultrafiltration (UF) passes ions and rejects macromolecules (0.005 to 0.1 micron) and removes organics from process solutions
- nanofiltration (NF) is used for larger size rejection than reverse osmosis (rejects molecules larger than 0.001 to 0.008 microns).

Environmental considerations

Energy is used in pressurising the systems.

2.7.13 Reverse osmosis

Reverse osmosis, effectively filtration of ions through a semi-permeable membrane at high pressure, provides an alternative means of concentrating metal impurities for subsequent removal. This approach can be capital intensive and any solids, together with organics, have to be removed prior to treatment.[3, CETS, 2002].

Environmental considerations

The technique runs at high pressures with a subsequent energy demand.

2.7.14 Diffusion dialysis

Diffusion dialysis is a membrane separation process that typically uses an anionic exchange membrane to transport acid anions and protons from waste acid solutions into deionised water streams (for treatment in waste water treatment plant) and the acid is recovered.

2.7.15 Membrane electrolysis

Membrane electrolysis uses one or more ion-selective membranes to separate electrolyte solutions within an electrolysis cell. The membranes are ion-permeable and selective. Cation membranes pass cations such as Cu and Al, but reject anions. Anion membranes pass anions, such as sulphates and chlorides, but reject cations

Environmental considerations

The electrolytic reactions may generate hazardous gases, depending on the solutions.

2.7.16 Electrodialysis

Anions and cations are removed from solutions with an applied electric field in cells with alternating anion- and cation-permeable membranes

2.8 Barrel processing

The use of barrels is described in 0 and 2.2 above.

Processing is carried out as described in the generic jig Sections 2.4 to 2.6. The following sections refer specifically to activities normally associated with barrel treatments.

2.8.1 Workpiece preparation

Deburring and tumbling, as well as degreasing workpieces for barrel treatment by centrifuging are described in Section 2.3.

2.8.2 Core activities

Core activities are the same as for jigs or racks, except chromium and anodising where barrel use is impossible. Workpieces should be small and without flat areas to prevent the flat surfaces adhering during treatment. This can cause marking, or in some cases burning, from uneven surface treatment [121, France, 2003].

2.8.3 Drying for barrelled components

Barrel plants use centrifugal drying or hot air drying depending upon the type of component. Centrifugal drying is effective and energy efficient.

2.9 Continuous coil – large scale steel

[73, BSTSA, , 86, EIPPCB,]. The coating of large steel coils is traditionally associated with the production of the coil. Coils weigh up to 32 tonnes and can be up to 2080 mm wide [119, Eurofer, 2003].

Finished cold-rolled steel (pickled, cold-rolled, annealed and tempered) is a material with mechanical characteristics that make it suitable for use in many industrial applications. Unfortunately, it suffers the major disadvantage of low corrosion resistance. The use of surface treatments to improve the corrosion resistance of the coiled steel substrate is described in this document.

Electroplating is a major surface treatment for large scale steel coil production. Other surface treatment options of printing and painting are discussed in [90, EIPPCB,].

The electrolytic coating procedure is fundamentally the same as that used in jig and barrel processes, even using similar solution chemistries. It is also preceded by the same type of pretreatments such as cleaning and pickling, and followed by post-treatments including layer conversion techniques such as chromating and phosphating. The specific activities for steel coil are described below.

There are two key differences for large-scale steel coil:

- the size and nature of the coils and the equipment used to handle and process them. These require:
 - coil handling equipment
 - loading and unloading systems (entry and exit loopers)
 - equipment to keep the coil in process at the right tension and flat (to prevent coil distortion and contact with anodes)
 - edge trimming to size.
- the continuous nature of the substrate, with only small thickness and limited width changes. This allows the use of some techniques that cannot be used for jig and barrel systems (which have constantly changing shapes of components), such as:
 - brushes to assist with activities such as degreasing and wringer rolls to reduce process solution drag-over
 - the continuous nature of the strip and the type of plant layout also lends itself to the widespread use of other techniques such as spray rinses and electrostatic oiling which are used less frequently in other transport systems.

A typical process outline is described in Figure 2.11. Details for specific process lines are described in the following sections.

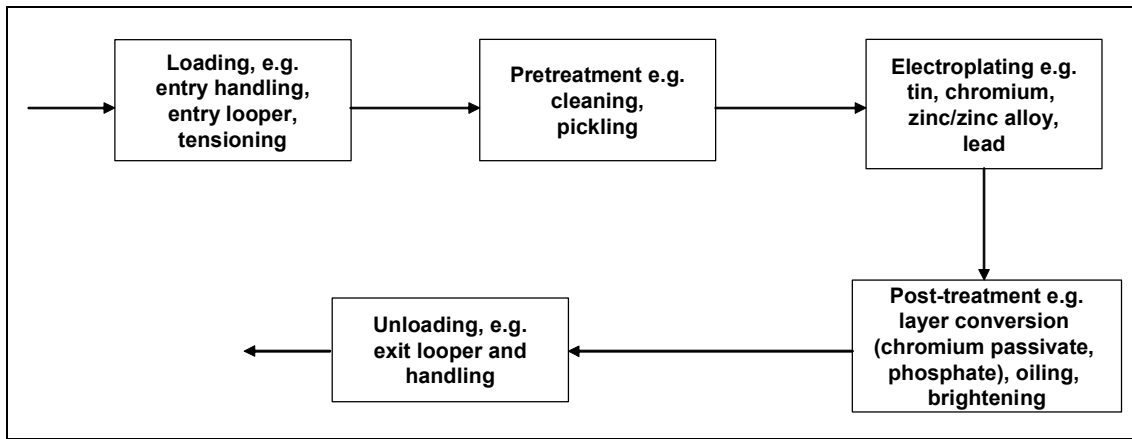

Figure 2.11: Outline of typical coil coating process

2.9.1 Entry equipment

The reception of coils, the uncoiling and welding of the coil end with the start of the next coil allows for a continuous process. The entry equipment involves the following:

- transport between the storage of uncoated steel coils to the uncoilers by means of a transfer chain, fork lift or an air-cushion vehicle
- uncoiling of the strip (including uncoiler, magnetic strip and pressure rolls)
- the entry looper guarantees that the strip can go on moving at a constant speed in the processing section even during welding when the strip end is held still at the entry section. The looper stores coil by running it through a series of vertical or horizontal loops. These are then used when the coil end is held still for welding on a new coil
- shearing of coil tails and scrap collection
- seam welding of the coil end with the start of the next coil
- continue strip thickness measurement
- tension leveller: used at the entry section or prior to any point where flatness is essential such as running between anodes or edge trimming knives. This flatness is corrected continuously by traction and flexion.

Environmental considerations

Power consumption can be assisted by maintenance of correct settings and ensuring bearings are free running.

2.9.2 Rinsing and drag-out

These activities are described in Section 2.4. Specific control techniques for coil processing are described for the individual processes.

2.9.3 Pretreatment

2.9.3.1 Degreasing and cleaning

The coiled blackplate is usually contaminated with fatty residues (oil and grease) and mill dirt (amorphous carbon or abraded iron fines) left over from the rolling process. It is essential that the surface of the steel strip is free of these impurities to ensure the entire surface is exposed to the treatment activities to ensure strong adhesion of the coatings is achieved.

Aqueous systems are now standard, and solvent degreasing is no longer used.

The cleaning is usually a combination of soak and electrolytic activities, see Section 2.3. Cleaning solutions are usually based on sodium hydroxide, phosphate or polyphosphates and wetting and complexing agents.

Electrolytic cleaning.

Impurities such as grease, oil, amorphous carbon or abraded iron fines may exist in the depressions of the surface roughness after the degreasing treatment. It is essential that these impurities are removed to ensure a strong adherence of the coating and it is achieved by electrolytic cleaning.

The uncoiled strip is polarised, either:

- directly - where the strip passes over a conductor roll, and then travels between two pairs of mild steel electrodes. The current passes from the conductor roll via the strip and electrolyte to the electrodes, or
- indirectly - grid electrodes where the steel strip travels between two pairs of mild steel plates which form two electrodes of opposite polarity. The current passes from one pair of electrodes via the electrolyte and the strip to the other pair of electrodes.

The electrolysis of the alkaline solution produces the release of H₂ gas at the cathode and of O₂ gas at the anode. The polarity of the electrodes is inverted after each coil or after a certain time to avoid polarisation.

Environmental considerations

See Section 2.3.4 and the individual processes.

Where oily waste is collected from the activities, it is usually treated off-site.

2.9.3.2 Pickling

Although the strip should be free of surface oil and dirt as it leaves the cleaner rinse, oxides formed during the various stages of steel processing are not removed. The purpose of acid pickle is to remove these oxides and lightly etch the strip to present as clean a steel surface as possible to the plating section. Strip pickling can be carried out by immersion, spraying or more commonly by electrolysis, with the same electrical arrangements as for cleaning, i.e. contact rollers or grids. See also Section 2.3 and [86, EIPPCB,].

Lead anodes are used because of the 50 g/l (max) concentration of the sulphuric acid electrolyte.

Electrolytic pickling (bipolar action) in neutral electrolyte (Na₂SO₄) may also be used in treating steel coil [113, Austria, 2003].

Environmental considerations

See Section 2.3.6.

2.9.4 Coating activities – electroplating

The materials commonly used for electroplating steel strip because of their special characteristics are: tin, chromium, zinc, copper, lead and some of their alloys. Electrolytic reactions are described at the start of Chapter 2.

Electrolytic cells for continuous steel coil

The cleaned and pickled strip is fed through electrolytic cells. The electrolytic cells are the heart of an electrolytic line. The choice, design and sizing of the other line components and supplying sections are dependent on the choice of the electrolytic cell and its components.

The main components of a continuous coil electrolytic cell are:

- conductor roll: this gives the steel strip a negative electrical charge. The voltage is transformed into current by means of a rectifier. The negative pole of the rectifier is connected to the carbon brushes of the conductor roll
- press roll: provides good contact and high electric conductivity between conductor roll and steel strip
- anode: repels the positive ions towards the steel strip (cathode). The positive pole of the rectifier is connected to the anode
- sink roll: turns the steel strip by 180°
- wringer rolls or squeeze rolls: minimise the drag-over (drag-in) into the next cell
- edge masks: prevents zinc edge overthrow (build-up of zinc preferentially at the edge of the coil where charge density is highest)
- conductor roll cleaning device: cleans the surface of the conductor roll to avoid surface defects on the steel strip.

The choice of an electrolytic cell depends on the industry applications the producer intends to supply, on the layer thickness they intend to deposit and on the capacity they intend to install. Electrolytic cell type is a function of four main parameters:

- cell geometry
- current density
- electrolytic solution type
- anode type.

Cell geometry

The three main types of cell geometry are:

Vertical cell

The two strip sides may be coated simultaneously in one cell. On entry to the cell the strip runs from top to bottom, from the conductor roll through one pair of guiding rolls and the first anode pair down to the sink roll. From there it runs to the exit side, upwards through to the second electrode pair and wringer rolls and on to the next conductor roll.

Conventional cells are filled in with electrolyte and the sink roll and the two pairs of anodes are submerged in the electrolyte bath. In the Gravitel cell, the electrolyte enters via a weir in the narrow gap between the insoluble anode and the strip, holding only a small amount of electrolyte in contact with the strip. In this case, neither the anodes nor the sink roll are submerged in the electrolyte.

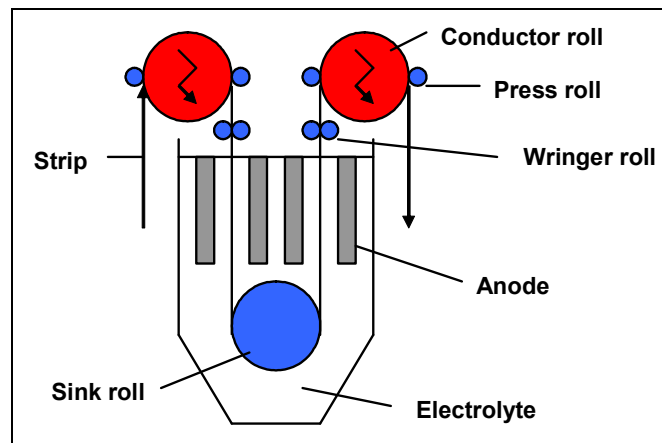

Figure 2.12: Vertical cell

Radial cell

Only one side of the strip may be coated at a time in one cell. On entry to the cell, the strip runs from the top to the bottom, from the conductor roll through one pair of wringer rolls down to the sink roll. From there the strip runs to the exit side, upwards through the wringer rolls and on to the next conductor roll. Only the lowest part of the sink roll is plunged in the electrolyte bath.

In a variant, the carousel cell, the top rolls have the function of deflector rolls while the sink roll, equipped with a metallic winding, combines the functions of deflector roll and conductor roll.

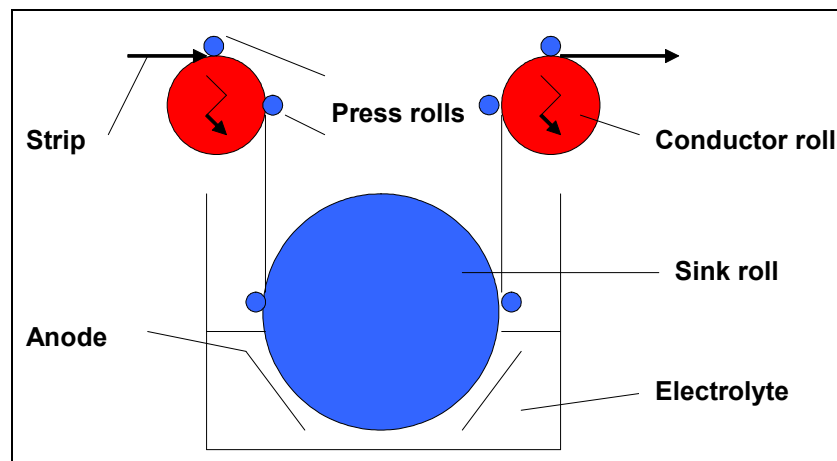

Figure 2.13: Radial cell

Horizontal cell

Both strip sides may be coated simultaneously in one cell. The strip runs horizontally through the cells. At the entry to the cell, the strip leaves the conductor roll and runs through one pair of wringer rolls, then between a pair of anodes and from there to the exit side, onwards through another pair of wringer rolls to the next conductor roll. The electrolyte is continuously injected between the two anode pairs, thereby only holding a small amount of electrolyte in contact with the strip at any one time.

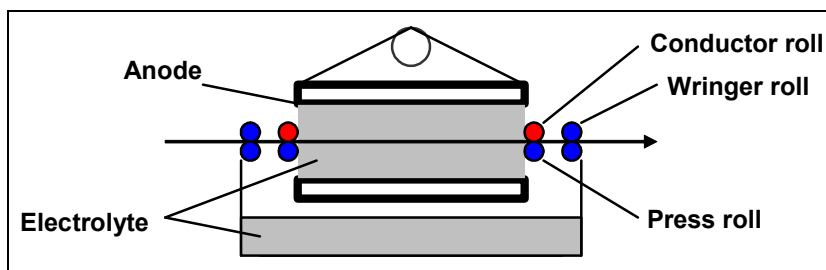

Figure 2.14: Horizontal cell

Current density

Installations normally working at low current density can be differentiated from those normally working at high current density. The current density will depend on the main industrial application, the normal metal thickness required and the normal steel substrate thickness. Table 2.1 shows thicknesses for zinc and zinc alloy coil coating applications. A high current density allows a thicker metal layer to be plated onto the steel substrate with a shorter anode length.

Current density (A/dm ²)	Main industrial applications	Zinc layer thickness (μm)	Steel thickness minimum (mm)	Electrolyte relative speed (m/sec)
60 to 120	Vehicle	5 to 12	0.5	1.0 to 4.0
30 to 90	White goods	2.5 to 3.5	0.3	<1.0
30 to 90	Others	2.5 to 3.5	0.3	<1.0

Table 2.1: Zinc and zinc alloy layer thickness as a function of industry application

High current density cells are equipped with systems such as electrolyte injection devices to realise a high relative electrolyte speed (electrolyte speed versus strip speed). These systems assure a sufficient supply of metal ions to the polarisation layer at the steel strip surface to carry the current.

Electrolyte bath

These are described for each process separately, see Sections 2.9.8, 2.9.9 and 2.9.10.

Anode type and gap

Two families of anodes are available: soluble anodes and insoluble anodes, see the introduction of Chapter 2, Electrolytic cells and reactions.

The gap between the anode and the steel strip differs as a function of the cell geometry and of the maximum steel strip width.

Electrolytic cell	Minimum gap (mm)
Vertical	16 to 26
Vertical gravitel	7 to 14.5
Radial	7 to 15
Horizontal	10 to 20

Table 2.2: Gaps between anode and steel strip for different electrolytic cell types

2.9.5 Coating activities – oiling

A wet film of oil is applied to the surface by spray, by wringer rolls or by an electrostatic oiler. This provides a coating for improving protection against white rust (oxide layers on zinc plating) corrosion. It can also act as a lubricant film to minimise subsequent damage by abrasion, to facilitate sorting and to aid in subsequent lacquering and printing operations.

2.9.6 Layer conversion activities

In order to prevent surface damages and flaws during storage and transportation, such as white rust (zinc corrosion) caused by water condensation where there is insufficient air access, the deposited layer may be subsequently phosphated (see Section 2.5.16), passivated with a chromate treatment (see Section 2.5.17) and/or oiled prior to recoiling (see Section 2.9.5). These layers also significantly improve the processing properties, during these and subsequent processes, such as painting or deep drawing.

2.9.7 After treatment activities

2.9.7.1 Drying

The strip is dried by means of hot air drying devices. The hot air temperature depends on the process stage. The drier device is usually situated at the end of the post-treatment; the same type of device is used for the phosphate and the chromate sections. See Section 2.6.2.

Environmental considerations

Energy efficiency according to type of drier and the installation.

2.9.7.2 Unloading - exit looper

The exit looper allows the strip end to remain at standstill in the exit section during the cutting of a completed coil. It stores sufficient coil for the strip to continue moving at a constant speed in the processing section. Construction and operation is the same as for an entry looper, with the coil running in the reverse direction.

Environmental considerations

Power consumption which will be minimised by maintenance of correct settings and ensuring bearings are free running.

2.9.8 Continuous electrolytic zinc or zinc nickel plating activities

This is the electrolytic deposition of a thin layer of pure or alloyed zinc onto the surface of a steel strip substrate.

On continuous electrolytic zinc plating line, the cold rolled, annealed and tempered steel strip is passed continuously through degreasing and pickling pretreatments, then through a series of electrolytic cells containing a zinc electrolyte. It is then passed through one or more post-treatments, either layer conversion such as chromating or phosphating, or through an oiling step.

Plating lines layout may vary in design. As an example, Figure 2.15 shows a typical layout of a continuous electrolytic zinc plating line.

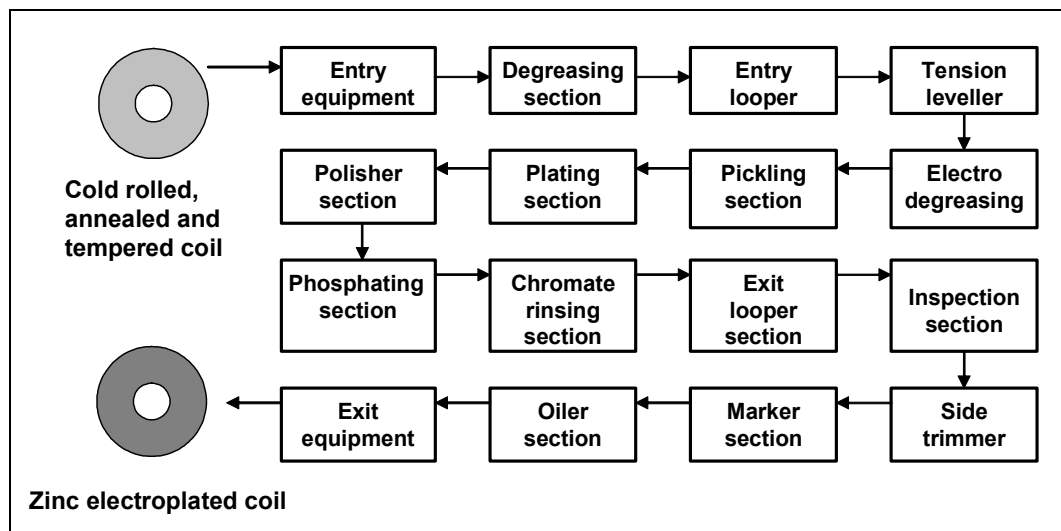

Figure 2.15: Schematic of an electrolytic zinc coating line layout

2.9.8.1 Entry equipment

See Section 2.9.1.

2.9.8.2 Degreasing

Degreasing of steel strip surface is by means of both chemical action (alkaline agent) and mechanical action (spray and brushes).

The cleaning process involves the following steps:

- alkaline degreasing via immersion or by spraying. This may be coupled with brushing
- rinsing with water and brushing between intermediate rinsing tanks
- drying.

The degreasing and rinsing sections may be in horizontal or vertical tanks.

Alkali degreasing

A typical horizontal spray degreasing section for the treatment of oiled coils consists of three successive stages:

- stage 1: spray nozzles and brushes
- stage 2: spray nozzles
- stage 3: spray nozzles and brushes.

Cascade degreasing has the advantage of achieving a high cleaning rate using only a small amount of degreasing solution. Degreasing is performed in counter-flow direction to the steel coil movement, which means that clean degreasing solution is used in the third (final) stage where it becomes slightly contaminated. This degreasing agent is used for cleaning in the second (more contaminated) stage and subsequently in the first (most contaminated) degreasing stage. The degreasing agent overflows between any two stages are controlled by means of wring rollers.

Section 2.9.3.1 describes typical chemical degreasing systems. In steel coil coating, the degreasing agent is usually an alkaline containing phosphate (a non-siliceous solution) containing mainly sodium hydroxides, orthophosphates and surfactant compounds with a concentration of 5 to 40 g/l, a temperature between 60 and 85 °C and a pH of about 13. The degreasing solution may be used first in the electrolytic degreasing section and be moved to the chemical degreasing stage to replace the spent chemical degreaser.

Environmental considerations

The use of cascade degreasing minimises the amount of raw materials and water used.

When the cleaning solution has reached the maximum oil content it is regenerated by centrifuges.

The solution may be used first in the electrolytic degreasing section.

Fumes generated in degreasing and brushing are normally collected, scrubbed and treated prior to release.

Spent degreasing agent is sent to waste water treatment before release.

The oily waste is treated off-site.

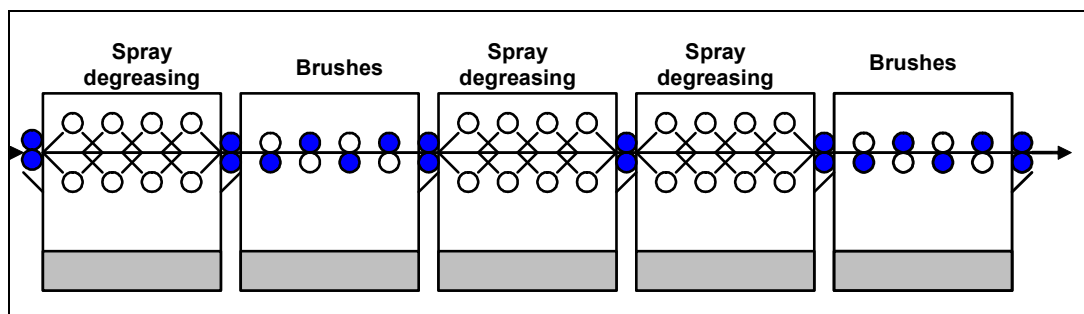

Figure 2.16: Spray degreasing and brushing

Rinsing

See Section 2.4. The alkaline degreaser is completely removed by cascade rinsing in three stages. Cascade rinsing has the advantage of achieving a high cleaning rate using only a small amount of rinsing water. Rinsing is performed in a counter-flow direction to the movement of the steel strip: the clean water is used in the third stage where it consequently becomes contaminated. This slightly contaminated water is then used for cleaning in the second stage and subsequently in the previous rinsing stage. The water overflows between two stages are controlled by means of wring rollers. The rinsing equipment involves the following steps:

- stage 1: spray nozzles and brushes
- stage 2: spray nozzles
- stage 3: spray nozzles.

The process solution in the first stage is demineralised water at a temperature of 70 to 85 °C.

Quality control techniques are used to determine the oil content in the water which gives the required standard of cleaning with minimum water usage. During processing, when the oil content in the water has reached this maximum allowed concentration, the water is sent to waste water treatment before discharge.

Environmental considerations

Countercurrent rinsing optimises process efficiency and minimises use of heated demineralised water.

Used water is treated to remove oil prior to discharge.

Water vapour and/or fumes generated in rinsing and brushing are collected and injected into the rinsing tanks.

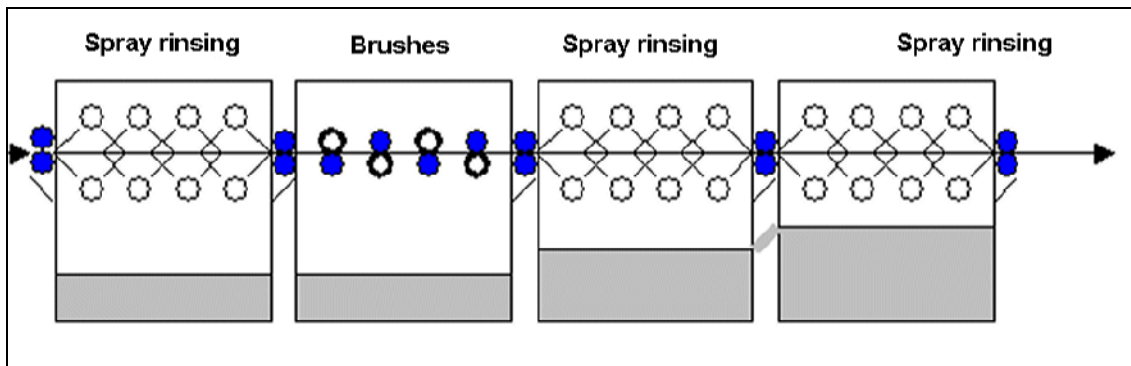

Figure 2.17: Spray rinsing

2.9.8.3 Drying

The degreased strip is dried by means of a hot air drying device. The hot air temperature lies between 100 and 120 °C.

Environmental considerations

Energy efficiency.

2.9.8.4 Entry looper and tension leveller

See Section 2.9.1

2.9.8.5 Electrolytic degreasing

The final degreasing of steel strip surface is carried out by means of chemical (alkaline agent) and mechanical (sprays and H₂ and O₂ gases bubbles generated by electrolysis at the strip surface) actions, see Section 2.3.8.

The electrolytic degreasing section involves the following steps carried in cells:

- alkaline degreasing by an electrolytic system
- rinsing with water, possibly coupled with brushing.

The degreasing and rinsing sections may be in horizontal or vertical tanks.

The electrolytic degreasing is carried out by the electrolysis of the alkaline solution releasing H₂ gas at the cathode and O₂ gas at the anode. The polarity of the electrodes is inverted after each coil or after a certain period in order to avoid polarisation. The solution drag-out to the next stage is controlled by means of wringer rollers.

The degreasing solution is usually the same as that used in the degreasing section. Once the solution has reached a certain oil level it is re-used on the degreasing section (cascade use). The operating temperature of the solution lies between 60 and 85 °C.

Environmental considerations

Re-use of the solution in the more contaminated degreasing section is possible.

Alkali fumes generated in electrolytic degreasing cells are usually collected, scrubbed and treated prior to release to maintain a healthy working environment and to prevent corrosion of equipment and substrates.

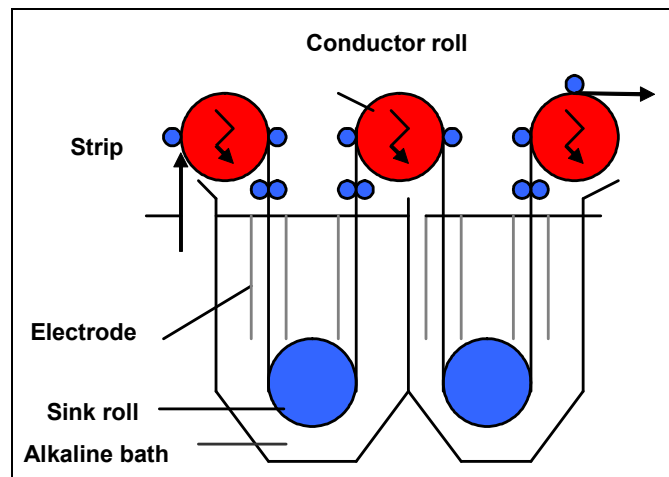

Figure 2.18: Electrolytic degreasing

Rinsing

Cascade rinsing in two stages completely removes the alkaline solution. Cascade rinsing has the advantage of achieving a high cleaning rate using only a small amount of rinsing water. Rinsing is performed in the counter-flow direction (i.e. the water flows in the opposite direction to the coil). This means that clean water is used in the last stage where it consequently becomes contaminated. This slightly contaminated water is used for cleaning in the second stage and subsequently in the previous rinsing stage. The water drag-over between two stages are controlled by means of wringer rolls. The rinsing equipment involves the following steps:

- stage 1: spray nozzles and brushes
- stage 2: spray nozzles.

Demineralised water having a temperature of 70 to 85 °C is used in the first stage.

Environmental considerations

Use of countercurrent rinsing to minimise use of heated demineralised water.

Water vapour and alkali fumes generated in rinsing and brushing are usually collected and injected in the rinsing tanks.

When the water has reached the maximum allowed oil content commensurate with process quality, it is sent to waste water treatment before release.

2.9.8.6 Pickling

Pickling removes any oxides formed during the various stages of steel processing and prepares a reactive steel surface for the plating section. For further information, see [86, EIPPCB,].

Coil pickling can be carried out by spraying, or immersion with or without electrolysis. Typical pickling sections involve the following steps:

- stage 1: pickling
- stage 2: rinsing.

Spray pickling

Two types of pickling solution may be used:

- sulphuric acid at a concentration within a range of 10 to 60 g/l with a temperature range of 25 to 60 °C.
- hydrochloric acid at a concentration within a range of 100 to 150 g/l with a temperature range of 20 to 40 °C.

Both the temperature and the acid concentration are dependent on the available pickling time (which is a function of the contact length and the maximum strip speed).

Environmental considerations

Fumes generated in pickling are usually collected and scrubbed prior to release. In some lines, the contaminated water of the scrubber is treated together with the fumes from the electroplating cells in an evaporator and both the concentrate and the evaporated water are returned to the process.

Spent pickling solution is sent to waste water treatment before release.

Spray rinsing

The same system is used as for degreasing (see Section 2.9.8.5).

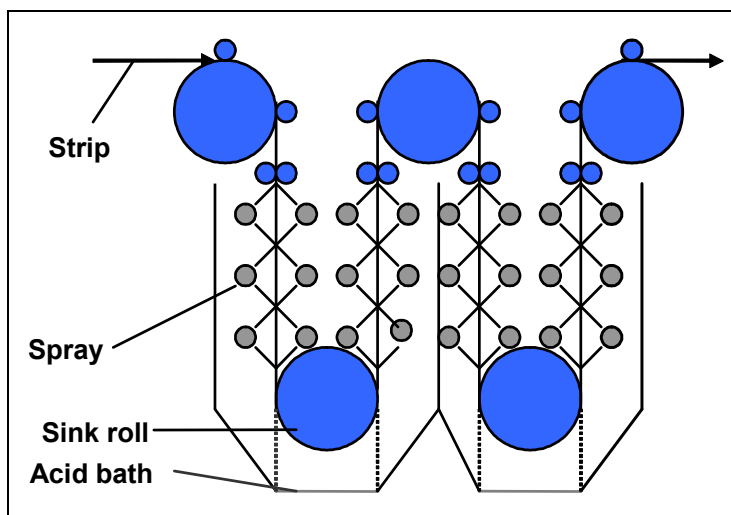

Figure 2.19: Pickling section

2.9.8.7 Electroplating

In this section, thin deposits of pure or alloyed zinc are electrolytically deposited onto the surface of a steel strip substrate. A typical plating section involves the following steps:

- stage 1: plating through several electrolytic cells
- stage 2: rinsing.

Sections 2.9.4 discuss the process and describe types of electrolytic cell. Current density for various zinc and zinc alloy thicknesses, and the industries they are used in are set out in Table 2.1.

Types of electrolyte bath

Electrolyte baths in continuous electrolytic zinc plating lines are predominantly acid-based. Alkaline-based electrolytes are no longer in common use. Electrolytes can be sulphate-based or chloride-based. The sulphate-based bath is used with soluble and insoluble anode processes. The chloride-based bath is only used with soluble anodes as chlorine gas is generated with insoluble anodes. In both baths, ionic additions are made to increase the conductivity of the electrolyte bath (e.g. sodium sulphate, aluminium sulphate, sodium chloride). Buffer additions are made to stabilise the pH (e.g. CH_3COONa).

Typical sulphuric base electrolytic bath compositions are:

- zinc 70 - 120 g/l
- free H_2SO_4 3 - 25 g/l
- Na_2SO_4 0 - 100 g/l
- pH 1.0 - 3.0 pH units.

Anodes types

These are generally described at the start of Chapter 2. For this process:

- soluble anodes: the zinc anodes are fixed on a supporting rail and, as they are consumed during the process, they are displaced from the entry side rail to the exit side rail
- insoluble anodes: two materials are used for the anode plate: a plate substrate in titanium coated with a thin layer of tantalum oxides or iridium oxides and a plate in lead alloyed with Sn or with Ag and In.

Rinsing step

The coil is then rinsed to completely remove the electrolyte from the strip surface. Also, in some cases where the coil is coated only on one side, the rinse may be used to pickle the zinc residues on the non-coated side. Rinsing can be carried out by immersion or by cascade spraying, and in horizontal or vertical tanks depending on the available surface. The same cascade principles described in the degreasing section are applied here, see Section 2.9.3.1.

Demineralised or fresh water is used, with a temperature of between 20 – 50 °C and a pH 0.3 to 3 (among other control parameters).

When the water has reached the maximum allowed contaminant (electrolyte) content determined by quality control, it is sent for waste water treatment before discharge. In some lines, the contaminated water is treated in an evaporator. The evaporated water can be re-used for rinsing and the concentrate re-used in the process electrolyte.

Environmental considerations

Counter-flow cascade rinsing can maximise the rinse efficiency and minimise the use of hot demineralised water.

Re-use of the water outputs distilled from evaporators.

2.9.8.8 Strip polisher

The strip polisher is used to clean the tarnished/oxidised uncoated side of the strip and to remove any stray coating particles which may have been deposited. When producing single sided coated material, some lines omit the polishing technology.

A typical polishing section involves the following stages:

- stage 1: polishing
- stage 2: rinsing
- stage 3: drying.

Polishing

Brushes are used to polish the cold reduced surface on the uncoated side. Demineralised water is used. The metal particulates are filtered from the used water.

Environmental considerations

The used water is sent to waste water treatment before release.

Rinsing

The strip is passed through a hot water rinse to remove any debris, before being dried. Rinsing can be carried out by immersion or by cascade spraying, in horizontal or vertical tanks depending of the available surface. The same principles as described for the degreasing section are applied. See Section 2.9.8.2.

Environmental considerations

The used water is sent to waste water treatment before release.

Drying

The polished strip is dried by means of a hot air drying device. The hot air temperature lies between 100 and 120 °C. The drier device is usually situated at the end of the post-treatment; the same type of device is used for the phosphate and the chromate sections. See Section 2.6.

Environmental considerations

Heat efficiency and losses.

2.9.8.9 Phosphating

This process forms a high quality light phosphate coat with the hopeite chemical structure which is widely used in the automotive industry and for household appliances. Phosphating can improve the performance of the zinc-coated strip with regard to drawability, corrosion resistance and subsequent paintability. See Section 2.5.16.

The strip is treated after zinc coating using spray banks in a two-stage process:

- stage 1: activation
- stage 2: phosphating.

Activating

The first stage consists of spray of a titanium refiner, which provides activation sites for the second stage of phosphate coating. The activation solution circulates in a closed loop. The pH lies in a range of 8 to 10, and the temperature is maintained below 40 °C. Spent (used, out of specification) solution it is treated in the waste water treatment section.

Phosphating

Phosphate coatings are described in Section 2.5.16. A phosphate coat of approximately 1 - 1.8 g/m² is applied. The phosphate system used can either be single or tricationic, depending on customer requirements. The hopeite crystal Zn₃(PO₄)₂·4H₂O incorporates approximately 1 % Ni and 5 % Mn. A refiner is added to ensure that the phosphate crystals deposited are small, uniform and tight, which enhances the performance of the coating.

Following phosphating, the strip is rinsed in a spray of dilute chromate solution to form a chromate seal. This seal further enhances the corrosion performance of the phosphate coating. The strip is then dried.

The phosphate solution circulates in a closed loop at a temperature below 40 °C.

Environmental considerations

See Section 2.5.16.

Spent solution is treated in the waste water treatment section.

Effluents may contain traces of nickel and manganese.

2.9.8.10 Full chromating and chromate rinsing

This is described in Section 2.5.17. A typical chromating section involves the following steps:

- stage 1: chromating
- stage 2: rinsing
- stage 3: drying.

Chromating

Full chromating or chromate rinsing of the strip after zinc coating is achieved using spray banks. Chromate rinse or passivation is a spray treatment with solvents containing chromic acids. A coat of 10 – 35 mg/m² per side is applied. During passivation, Cr(VI) is largely converted to Cr(III). The strip is treated with solutions between 0.5 – 2 % of chromium and at temperatures below 40 °C. The chromate solution circulates in closed loop.

Environmental considerations

General health and environmental issues for chromium passivation are described in Sections 1.4.4.1 and 2.5.17.

Spent (used, out of specification) solution may be treated in a typical waste water treatment plant or disposed of as hazardous waste.

Rinsing

Rinsing can be carried out by cascade spraying in horizontal tanks. The same principles as described for the degreasing section are applied. See Section 2.9.8.2

Environmental considerations

The used water is sent to waste water treatment before release.

Drying

The chromate rinse strip is dried by means of a hot air drying device. The hot air temperature lies between 100 and 120 °C which is necessary for the chemical reaction of the excess Cr(VI) with the solution additives to become Cr(III).

Environmental considerations

Heat efficiency and losses.

Anti-finger marking section

This provides a chromate coating for improving protection against white rust corrosion. This coating has the advantage of not showing fingerprints, which is critical for some customers.

A typical chromating section involves the following steps:

- stage 1: coating. The chromate coating is applied via a roller coater system, similar to that used in paint lines
- stage 2: drying. The wet coating is passed through an air oven to dry.

Environmental considerations

The coating is dried in place with no rinsing, so no effluent arises.

Heat efficiency and losses may need to be addressed for the oven.

2.9.8.11 Oiling

A wet film of oil is applied on the surface of the strip, see Section 2.9.5. The oiling coat is between 0.25 – 3 g/m²/side, applied in an electrostatic oiler, with the oil circulating in close loop.

2.9.8.12 Exit looper

See Section 2.9.7.2

2.9.9 Continuous electrolytic tin plating activities

Mild low carbon steel can be coated with tin either with equal or different thicknesses on either side, and in a range of thicknesses.

On a continuous electrolytic tin coating line, the blackplate strip is passed through cleaning and pickling pretreatments, then through a series of tanks containing a tin electrolyte. This process electrolytically deposits a light layer of pure tin onto the strip, which may be subsequently reflowed, then passivated and oiled prior to recoiling.

Plant layouts vary in design; some modern lines now incorporate a side trimming unit prior to pretreatment. Figure 2.20 shows a typical layout of a continuous tin coating line.

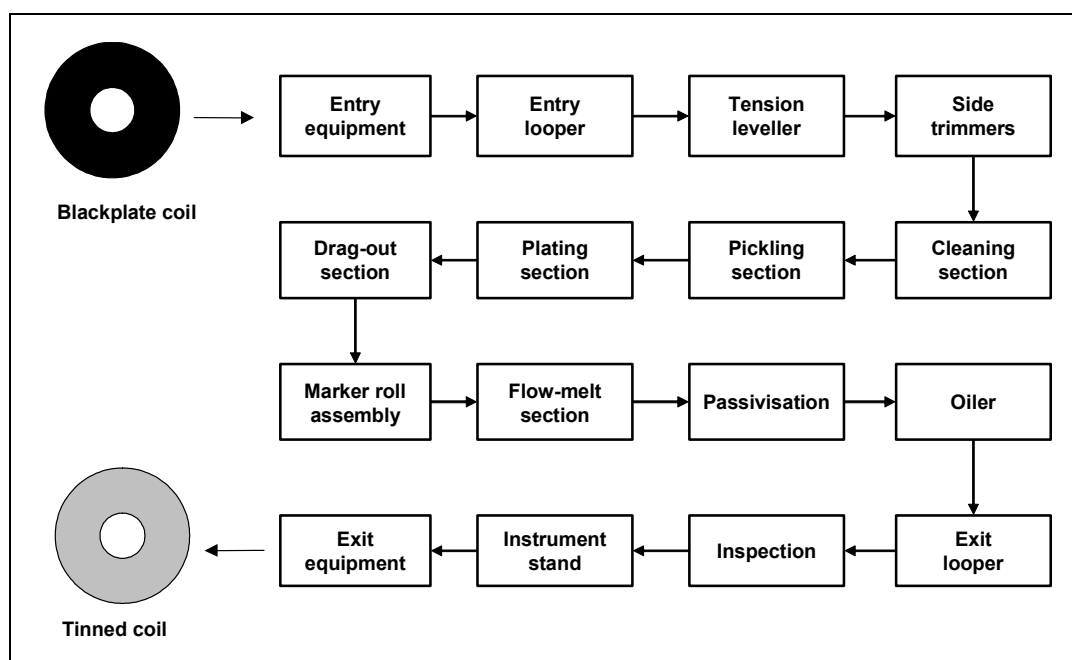

Figure 2.20: Schematic of a tin coating line layout

2.9.9.1 Degreasing and cleaning

As with other surface treatments, tin plating requires appropriate preparation of the substrate as poor surface condition can lead to inadequate adhesion of the tin or even dewetting during the remelting operation. See Sections 2.3 and 2.9.3.1. Cleaning solutions are usually proprietary mixtures of polyphosphates, sodium hydroxide and wetting agents. The chemical action of the bath is enhanced by electrolytic treatment. Concentrations range from 7 to 50 g/l and the solution is operated at a typical temperature of about 90 °C maintained by circulating the solution through a heated reservoir storage tank. Additions of water and cleaning compound are made as required. Figure 2.21 shows a typical cleaner section with rinsing.

The strip is polarised using one of two methods:

- directly - where the strip passes over a conductor roll, and then travels between two pairs of mild steel electrodes. Current passes from the conductor roll via the strip and electrolyte to the electrodes
- indirectly - by grid electrodes where the steel strip travels between two pairs of mild steel plates which form two electrodes of opposite polarity. Current passes from one pair of electrodes via the electrolyte and the strip to the other pair of electrodes.

Rinsing

Rinsing is as thorough as possible to avoid contamination of the pickle liquor pretreatment by the cleaning solution. It is carried out by spraying hot water, typically between 150 – 400 l/min.

Environmental considerations

Alkali fumes generated during cleaning are typically collected and scrubbed prior to release.

Spent cleaning agent and waste water from rinsing can be treated in a typical waste water treatment plant.

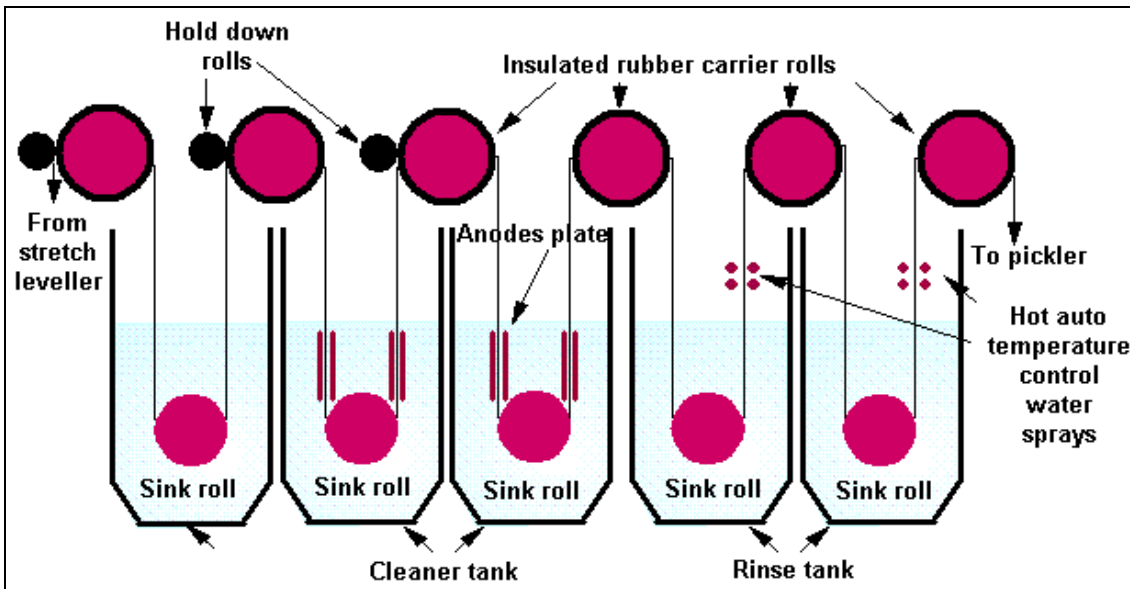

Figure 2.21: Schematic of a cleaner section

2.9.9.2 Pickling

See Section 2.9.3.2. Lead anodes are used because of the 50 g/l (max) concentration of the sulphuric acid electrolyte. The acid is deliberately not heated, but the process current induces an equilibrium temperature of 25 to 40 °C, depending on operating conditions.

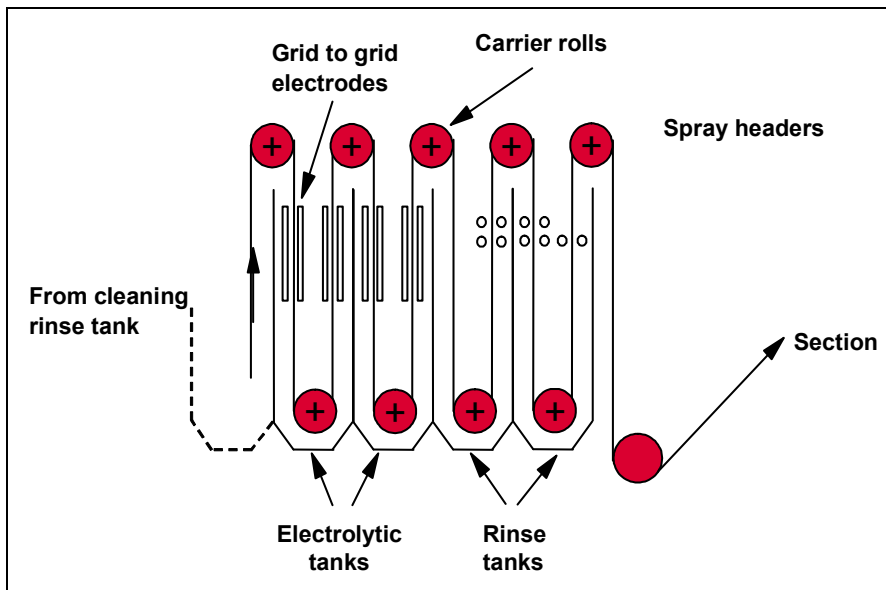

Figure 2.22: Schematic of a pickler section

Environmental considerations

Acid fumes generated during pickling are usually collected and scrubbed prior to discharge. Spent acids and rinse waste water are sent for waste water treatment prior to discharge.

2.9.9.3 Tin plating

There are two widely used tinning processes:

- the ‘Du Pont’ process which represents 20 % of worldwide tin plate production. It has the ability to accept high current densities. However the electrolyte composition is complex, with high chloride and fluoride contents making it highly aggressive to plant materials
- the ‘Ferrostan’ process is the most widely used, with between 75 and 80 % of worldwide tin plate production. This is due to the use of less hazardous and corrosive chemicals.

Other electrolytes are based on tin sulphate, tin fluoroborate or tin methyl sulphonate [113, Austria, 2003].

The plating section of a tinning line consists of several rubber-lined steel vertical tanks arranged in tandem. Each tank contains a rubber driven sink roll at its base and two chromium plated copper conductor rolls above the electrolyte surface. Current is transferred from the roll to the strip so that the strip becomes cathodic. Soluble tin anodes are hung from bridges across the vats into the plating electrolyte. Anodes are cast from electrorefined tin which is typically more than 99.85 % pure.

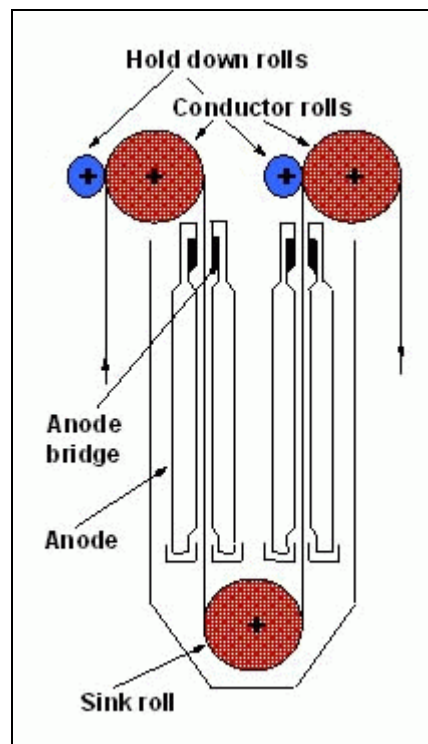

Figure 2.23: Schematic of a plating tank – vertical cell

The plating electrolyte consists of stannous sulphate, phenolsulphonic acid (PSA) and an organic addition agent. The stannous sulphate provides an initial source of tin ions in solution; the PSA makes the solution highly conductive and the addition agent ethoxylated alpha-naphthol sulphonic acid (ENSA) aids uniform and consistent tin deposition. This is essential for making the plate bright at after the later flow-melting stage.

Typical composition and temperature of tin electrolyte to ensure good plating conditions is:

- stannous tin 25 – 45 g/l
- phenol sulphonic acid (PSA) 20 – 27 g/l
- ENSA 1.5 - 6.0 g/l
- at temperatures of 30 – 55 °C.

The plating electrolyte is circulated through heat-exchangers, the rate of circulation being high enough to maintain a constant plating temperature for all coating weights.

2.9.9.4 Drag-out

After plating, the strip goes through a series of drag-out and rinsing operations.

At the drag-out tank, electrolyte is spray-rinsed with a dilute solution of PSA and a tin compound, and then returned to the electrolyte circulation tank. This tank is connected to an evaporator and the dilute electrolyte is concentrated by evaporation then recirculated back to the plating tank.

The exit squeeze rolls on the drag-out recovery tank leave the optimum amount of electrolyte on the strip required for 'fluxing' of the tin coating during melting. The film only needs to be dried before the strip enters the flow-melting or brightening unit which is accomplished by passing the strip through a series of hot air jets.

On high speed lines, a second drag-out recovery unit is provided to increase the dilution ratio. This means a recovery ratio of more than 90 % of the drag-out electrolyte is accomplished.

Environmental considerations

Dragged over plating solution can be concentrated and returned to the plating process.

Acid fumes generated during plating and drag-out may be collected by an extraction unit and are usually scrubbed prior to discharge.

2.9.9.5 Differential marking

Differential coatings are shown by marking one side of the strip usually with a solution of sodium dichromate. This is printed onto the strip in a pattern of diamonds, circles or, more commonly, lines. The solution is dried onto the strip and after melting will leave a dull, non-lustrous finish in the areas that have been in contact with the printer.

Environmental considerations

As for other chromium coatings, see Section 2.9.8.10.

2.9.9.6 Reflow – tin brightening

The tin coating deposited on the strip has a dull matt appearance. Reflowing or flow melting is the process used to give a bright lustrous finish. The strip is heated to above 232 °C (the melting point of tin) and then quickly cooled to solidify the coating. Melting is achieved by resistive heating (applying a voltage between two conducting rolls supporting the strip), supplemented by induction heating (which provides 20 % of the total energy).

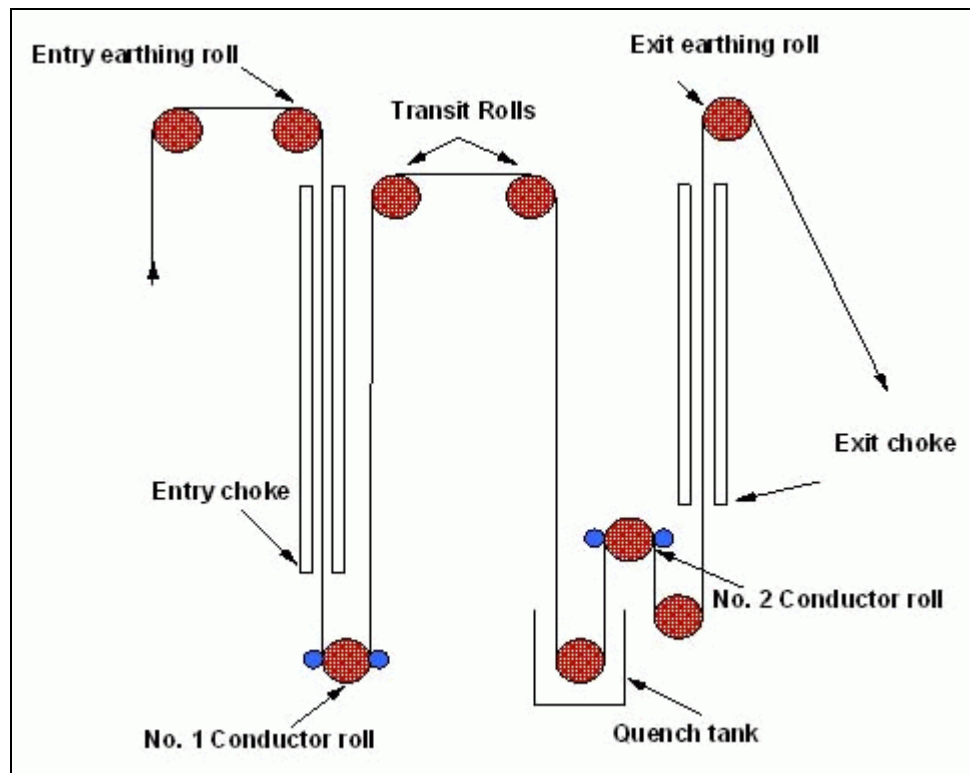

Figure 2.24: Schematic of flow-melt section

The mixed resistive and inductive heating makes it easier to obtain stable melting conditions, avoiding certain cosmetic coating defects.

Environmental considerations

Energy efficiency and energy losses.

2.9.9.7 Passivation treatments

Passivation is carried out by a chromating treatment, see Section 2.5.17, in order to reduce the thickness of tin oxides formed during remelting. The treatment electrolytically produces a layer containing chromium which prevents subsequent oxidation in air and also improves adhesion of the paint layer.

The operation is performed in a solution of sodium dichromate

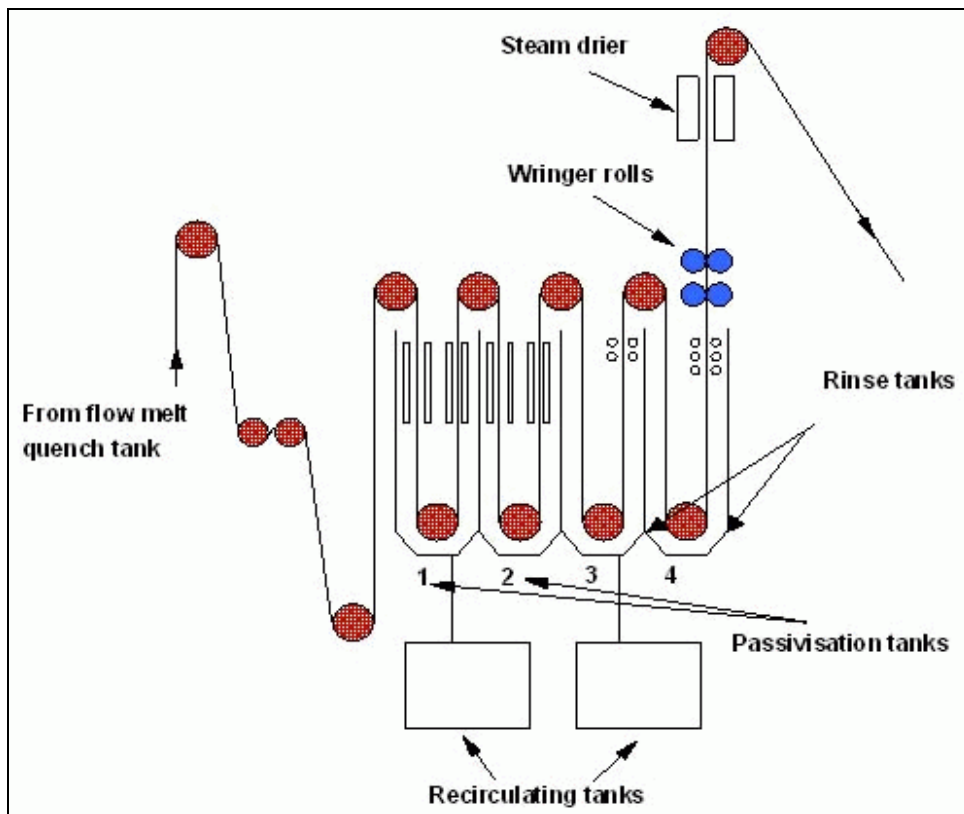

Figure 2.25: Schematic of passivation treatment

Environmental considerations

General health and environmental issues for chromium passivation are described in Sections 1.4.4.1 and 2.5.17.

Spent (used, out of specification) solution may be treated in a typical waste water treatment plant or disposed of as hazardous waste.

2.9.9.8 Oiling

Prior to recoiling the treated coil, a thin film of lubricant is applied to the tin plate surface. This film minimises subsequent damage by abrasion, facilitates sorting and aids subsequent lacquering and printing operations.

A pure grade of either dioxy sebacate (DOS) or acetyl tributyl citrate (ATBC) is used. The oil can be added by two methods:

- electrostatically, where a negatively charged oil mist is driven away from similarly charged repeller plates onto the surface of the strip
- emulsion oiling, where a thin, uniform oil film is applied by flooding the surface of the tin plate with a dilute oil-in-water emulsion.

The total oil levels on the strip range typically from 6.0 to 12.0 mg/m².

2.9.10 Continuous electrolytic chromium plating activities (electrolytic chromium coating of steel – ECCS)

This is also known as tin-free steel: a low carbon, mild steel, coated equally on both sides with a complex layer of metallic chromium and chromium hydroxides. The processes are described in general in Section 2.5.3, along with the health and environmental issues. Figure 2.26 shows a typical process line layout and Figure 2.27 gives a cross-section through a line. The chromium plating of the steel strip is performed electrolytically in a chromic acid bath. The coating is applied equally to both sides as a complex layer of chromium metal and chromium oxides. The overall process is similar to the electrolytic tin process – the steel strip is passed through the entry section of the line, cleaned, pickled and then treated electrolytically in a solution containing chromic acid, rinsed thoroughly, dried, oiled and then recoiled.

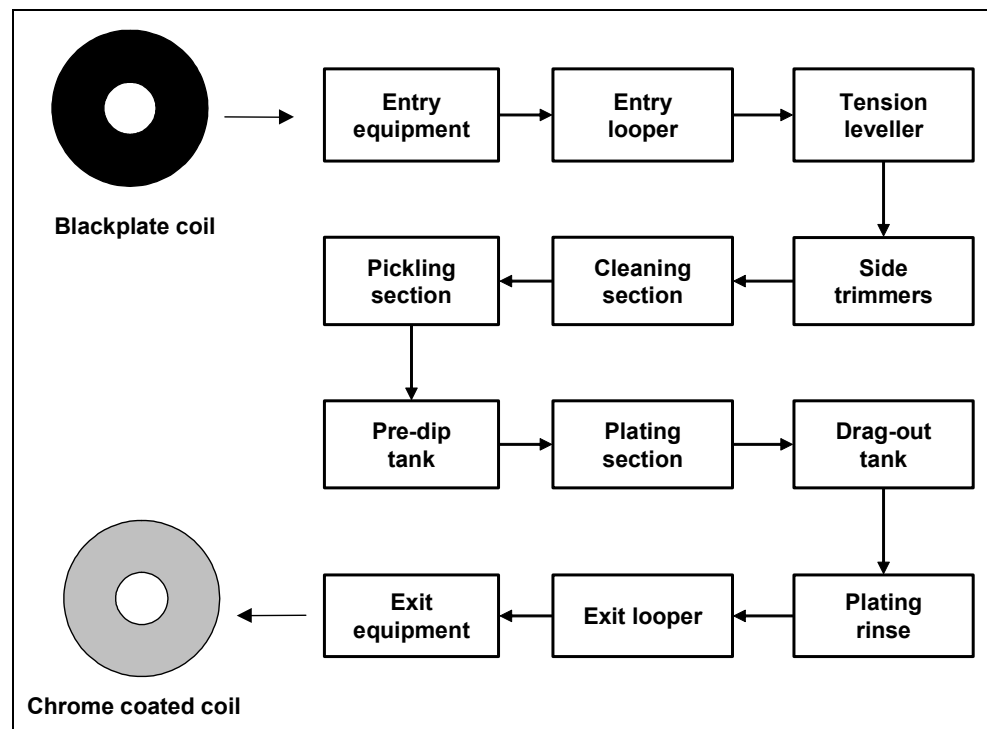

Figure 2.26: Chrome coating line layout

2.9.10.1 Degreasing and cleaning

Cleaning is performed electrolytically in an alkaline bath (see Section 2.3.8) and sodium hydroxide is generally used at concentrations of typically 50 to 90 g/l. Wetting agents and chelating agents are also added to the cleaning agent to improve cleaning performance.

- sodium hydroxide 60 - 65 %
- sodium phosphate 30 - 35 %
- wetting agent 0 - 2 %
- chelating agent 2 - 5 %.

Electrodes

Electrodes are made of mild steel plates. The polarity of the strip can be selected from anodic, cathodic or any combination of the two. The strip is polarised either:

- directly, where the strip passes over a conductor roll, and then travels between two pairs of mild steel electrodes. Current passes from the conductor roll via the strip and electrolyte to the electrodes, or
- indirectly, by grid electrodes where the steel strip travels between two pairs of mild steel plates which form two electrodes of opposite polarity. Current passes from one pair of electrodes via the electrolyte and the strip to the other pair of electrodes.

See Figure 2.18: Electrolytic degreasing

The temperature of the cleaning solution is kept constant by circulating the solution between the cleaning tank and the storage tank with a steam heater coil.

Rinsing

This is thorough to avoid contamination of the pickle liquor pretreatment by the cleaning solution. It is carried out by spraying heated water typically between 150 – 400 l/min.

Environmental considerations

Alkali fumes generated during cleaning are typically collected and scrubbed prior to release.

Spent cleaning agent and waste water from rinsing are sent for waste water treatment before discharge.

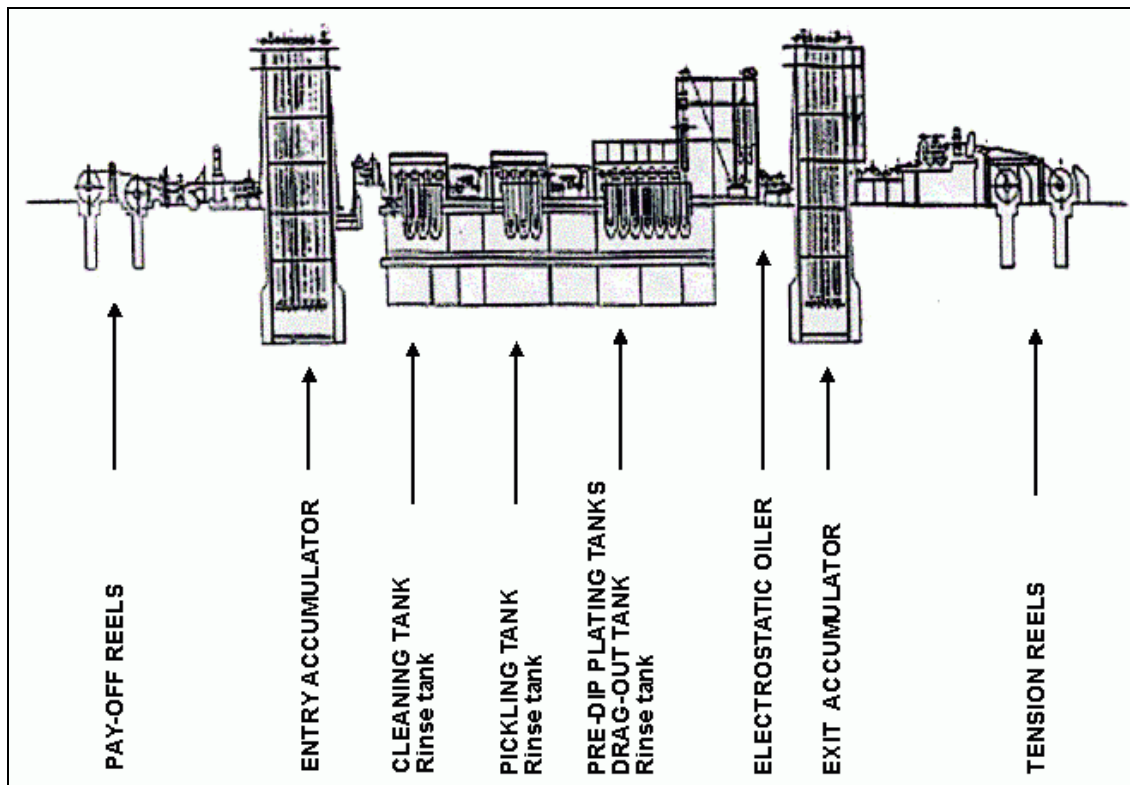

Figure 2.27: Typical arrangement of ECCS line

2.9.10.2 Pickling

Sulphuric acid is used for the pickling solution at concentrations of 60 to 115 g/l at ambient temperature. See Sections 2.3 and 2.9.3.2.

Environmental considerations

Acid fumes generated during pickling are usually collected and scrubbed prior to release.

Spent pickling agents and waste water from rinsing are sent for typical waste water treatment before discharge.

2.9.10.3 Chromium plating

See Section 2.5.3 for a general description of chromium plating and the health and environmental considerations.

Pre-dip

Before chrome plating takes place, the strip is passed through a pre-dip tank. This is essential to prepare the surface of the strip for electrodeposition and prevents stains and other surface defects forming on the surface of the strip. It is carried out in a sulphuric acid solution of 0.3 – 0.5 g/l at ambient temperature.

Electroplating

The strip is passed through an electrolyte containing Cr(VI) ions, which are reduced cathodically on the strip surface to form a duplex layer of hydrated chromium oxide and metallic chromium. The current applied is determined according to the strip width, line speed, current efficiency and aimed film weight and flows from the insoluble electrodes to the strip through the electrolyte, and then returns to rectifier through the conductor rolls.

The plating solution is pumped from a circulation tank, passed through a heat-exchanger and then travels up into the bottom of the coating tanks, which contain inert anodes of lead-antimony. It is overflowed from the top part of the tank and then returned to the circulation tank.

A typical plating electrolyte will consist of:

- chromic acid 110 - 130 g/l
- hydrofluoroboric acid (HBF₄) 0.30 - 0.44 g/l
- sulphuric acid (H₂SO₄) 0.60 - 0.80 g/l.

The hydrofluoroboric and sulphuric acids both act as catalysts: they improve the efficiency of the plating process but are not themselves consumed in the process. In the US, the solutions are more usually Cr/sulphuric acid only [73, BSTSA,]. Temperature can have a marked effect on the electrolyte efficiency; the solution is far more efficient at lower temperatures. However, because the electrolyte is heated by the electric current passing through it, the temperature has to be kept constant by the heat-exchanger which cools the solution. In operation the optimum temperature of the electrolyte is 58 +/- 2 °C.

Environmental considerations

The health and environmental issues are described in general in 2.5.3.

Acid fumes are generally collected and scrubbed prior to discharge. The scrubbing solutions may need treatment prior to discharge.

2.9.10.4 Drag-out and rinsing

At the drag-out tank, electrolyte is spray rinsed away and the washings are returned to the electrolyte circulation tank. This is connected to an evaporator where the diluted electrolyte is concentrated and returned to the process tank. The amount of spray rinse at the drag-out recovery tank and the capacity of the evaporator are decided from the chromic acid concentration in the effluent.

The chromic acid treated strip must be fully rinsed with water before drying, oiling and recoiling. The strip is sprayed with hot water at the entry and exit ends of the rinse tank to remove any carry-over of electrolyte or water-soluble constituents in the oxide film. Spraying is carried out at 50 – 60 °C with a flowrate of about 5000 – 10000 l/h. Spraying at higher temperatures and pressures could damage the freshly formed film.

Environmental considerations

The health and environmental issues are described in general in Section 2.5.3.

Chromium and other electrolyte components may be recovered by countercurrent rinsing and evaporation of drag-out.

Fumes generated during electrolytic plating and drag-out are collected by an extraction unit and typically scrubbed prior to discharge.

2.9.10.5 Oiling

Prior to recoiling, a thin film of lubricant is applied to the chrome-plated surface. The function of this film of lubricant is to minimise subsequent damage by abrasion, to facilitate sorting and to aid in the lacquering and printing operations. A pure grade of either dioxydyl sebacate (DOS) or acetyltributyl citrate (ATBC) is used. The oil is usually applied by an electrostatic oiler. See Section 2.9.9.8.

The aim weight of oil film on the strip is 3.0 – 7.0 mg/m²

2.9.11 Continuous electrolytic lead coating of steel

The only plant operating in Europe is due to close by 2005 or 2006. No specific information has been exchanged. General information on analogous coil and jig processes can be used for the majority of the activities and issues.

2.10 Sheet processing for aluminium lithography plates

[118, ESTAL, 2003], [38, Ullmann, 2002/3] Substrates for lithographic plates (see Section 1.3.3) must be easily and cheaply prepared, chemically resistant to acid and alkali solutions, and solvents in inks or for cleaning. They must also be flexible for fixing to rollers, physically robust and stable in use for print runs of thousands of copies, with a well defined microroughness and hydrophilicity for retaining and spreading the dampening agent. Aluminium is the substrate of choice as it can be easily prepared by the processes described in Sections 2.10.1, 2.10.2, 2.10.3 and 2.10.4.

2.10.1 Surface graining

Although the surface can be prepared mechanically, it is now more usual to use electrochemical graining. The raw aluminium surface is first degreased (see Section 2.3) and then uniformly corroded by using an AC treatment in dilute nitric acid, hydrochloric acid, or mixtures of these with other acids. This process of graining is a type of pitting corrosion which attacks the entire surface of the aluminium leaving a very uniform rough surface. The depth of roughness can be controlled within wide limits (2.5 - 9 μm) by varying the electrical parameters. Both processing speed and the uniformity of the resulting substrates depend on temperature, flowrate of the electrolyte, geometry of the tank, and other parameters. Combination processes have also been used in graining. In these processes, mechanical graining is followed by electrochemical treatment.

Graining with wire brushes produces the lowest increase in surface area of the plate, and electrochemical graining, the highest. This influences, not only the quality of reproduction and the optical resolution, but also the printing properties (water spreading and length of run). The finer the graining of an aluminium surface, the lower is the mechanical resistance. With wire-brushed aluminium, a second hardening step is not required. However, an anodic oxidation step is essential for electrochemically grained aluminium.

2.10.2 Anodic oxidation (anodising)

Anodic oxidation (as described in Section 2.5.13) involves conversion of the uppermost layer of the aluminium workpiece to aluminium oxide, without affecting the surface topography significantly. Two processes are in general use: sulphuric acid or a phosphoric acid electrolyte. The former leads to smaller pores and thicker oxide layers than the latter.

In general, not more than 5g of oxide is produced per square metre; depending on the roughness of the surface, this corresponds to a layer thickness of about 1 μm . The oxide formed during anodising is X-ray amorphous and an extremely strong adsorbent. The properties of the substrate are greatly improved during this step, i.e. the adhesion to the light-sensitive coating; resistance of the surface to chemicals; its hydrophilicity, hardness and abrasion resistance, and thus the potential of running length. However, the extent to which the aforementioned aspects can be effectively depends on process parameters and on the process itself.

2.10.3 Post-treatment

Post-treatment of the oxide with certain hydrophilising solutions has proved advantageous in the production of pre-sensitised (PS) plates. The main purpose of this treatment is to improve the hydrophilicity of the aluminium oxide surface. However, the adhesive properties, the ability to be photo-developed and shelf-life of the plates are all influenced at the same time. Solutions of the following substances have been proposed for this purpose: alkali silicates, phosphonic acids, hexafluorometalates of group 4 elements (titanium, zirconium, and hafnium), heteropolyacids, oxy acids of pentavalent phosphorus, and hydrophilic colloids. All of these compounds coat the surface of the aluminium oxide to generate a very polar covering layer, which improves the hydrophilicity of the surface.

2.10.4 Coating and further processing

Preliminary treatment of the carrier is followed by in-line coating of the plate in a fully continuous process. A solution of the components of the light-sensitive coating in a more or less volatile solvent mixture is applied to the carrier in a defined wet film thickness. The coatings are generally applied with a fishtail die, with a roller coater, or by spraying. The thickness of dry coatings is 0.3 – 5 mm.

The line speed in modern plants is <1 m/s. The length of individual steps is adjusted to this process speed. After drying, the web is automatically inspected for coating defects. It is cut apart, and defective plates are removed. Cutting of the plates requires special attention. Pre-sensitised lithographic plates are available in many sizes up to about 3 m^2 (1500×2000 mm).

The finished faultless plates are stacked by using a suitable interleaving paper and packed in lightproof wrapping paper (if necessary, after shrink-film packaging).

The shelf-life required for these pre-sensitised lithographic plates depends on the extent of their distribution. Also, the more diverse the climatic conditions under which the plates are to be stored and used, the more diverse are the requirements.

2.11 Printed circuit board manufacturing

[73, BSTSA,] Printed circuit boards are the basis of electronic sub-assemblies. They are electronic circuits, often complex, with the thin layers of tracking printed onto thin, non-conductive layers. Components such as resistors, capacitors, semi-conductors, mounts for processing chips and memory chips, etc. are added in subsequent operations (not described in this document). Modern electronic equipment demands a very high tracking density which is achieved in 'multilayers' or 'multilayer boards (MLBs)' where multiple conductive layers (cores) are separated by insulating layers called prepregs. A further development of this technique is the HDI (high density interconnect) board.

Processing is a complicated set of individual operations and will vary to produce any specific design of board. Over 40 activity stages may be used in the production of boards, although not all of them will be used for any one board design. Many of these stages have little or no environmental impacts and are only described briefly in the following sections.

In general, the base materials are phenolic paper, epoxy paper or epoxy glass laminates. For special applications, ceramic materials, flexible or flex-rigid materials are used. The base material is clad with copper on one or both sides, with a thickness usually between 5 and $105 \mu\text{m}$, depending on design requirements. Metals other than copper may be occasionally used for specific applications, such as aerospace. Examples of the construction of PCBs are shown in Figure 2.27.

The cores are laminated with prepregs, with copper foil outer layers. The cores and the copper foil are patterned and processed in similar ways, and some stages may be repeated to complete a complex multilayer board.

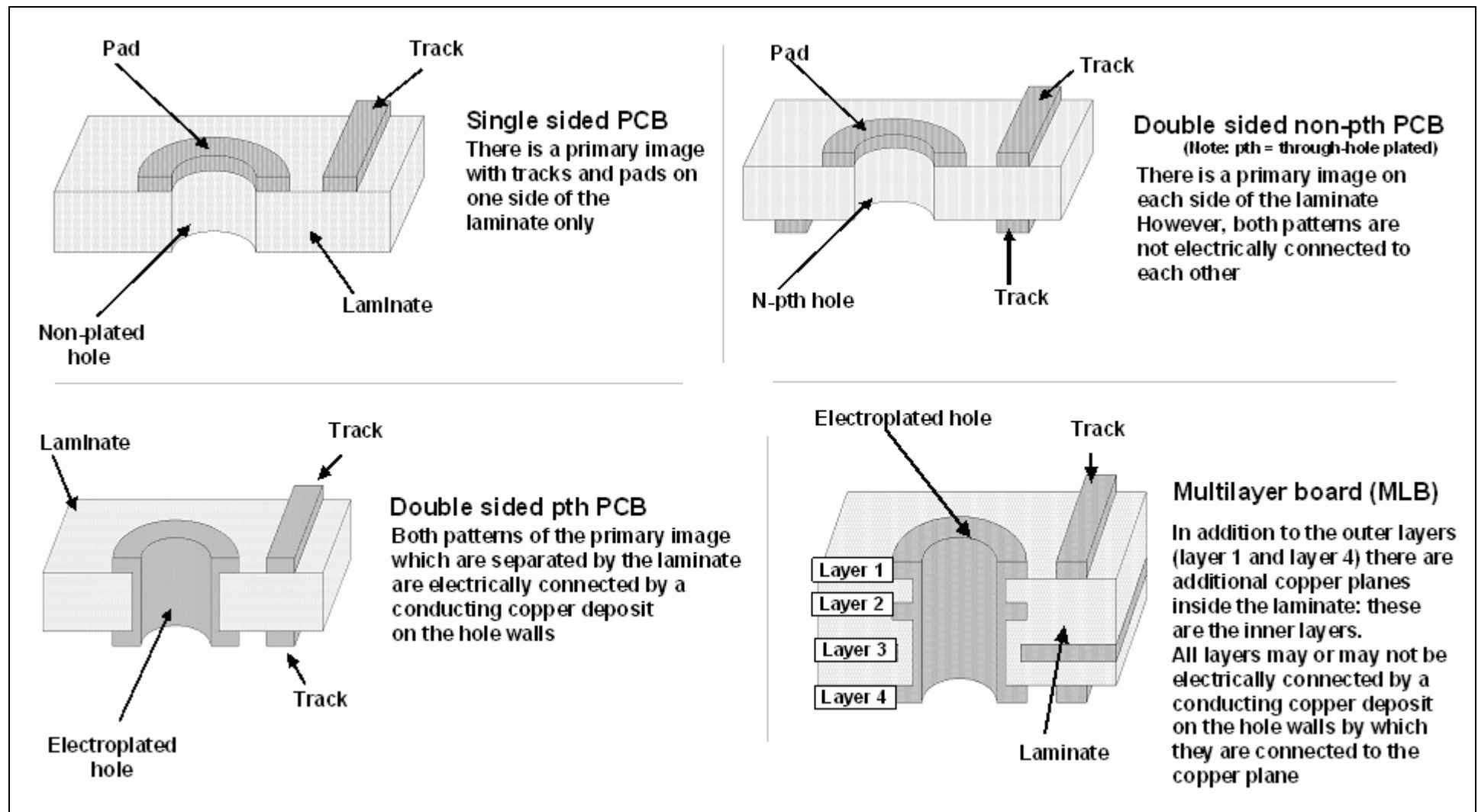

Figure 2.28: Examples of printed circuit board construction

Over 90 % of European production is made by a subtractive method, where copper is removed from the base layer to leave the conducting track. called a connect. Additive or semi-additive processes, which lay down a conductive track are not used often, and are not described.

The following Figure 2.28 shows the production steps involved in creating a typical multilayer board, as shown in Figure 2.35.

The overall process is complicated, with many of the steps being repeated.

The diagram shows first the ancillary operations essential to all PCB manufacture, such as production of the design and preparation of phototools.

The inner layers are created, assembled and the outer layers created around them.

Holes (called vias) may be:

- buried: not visible from the outside and drilled in the inner layers
- blind: visible from one side only and drilled from the outside
- visible and drilled right through.

The holes may be plated on the inside (known as through-hole plating, abbreviated to pth) to provide a connection between layers, see Figure 2.28. Non-plated holes are referred to as non-pth.

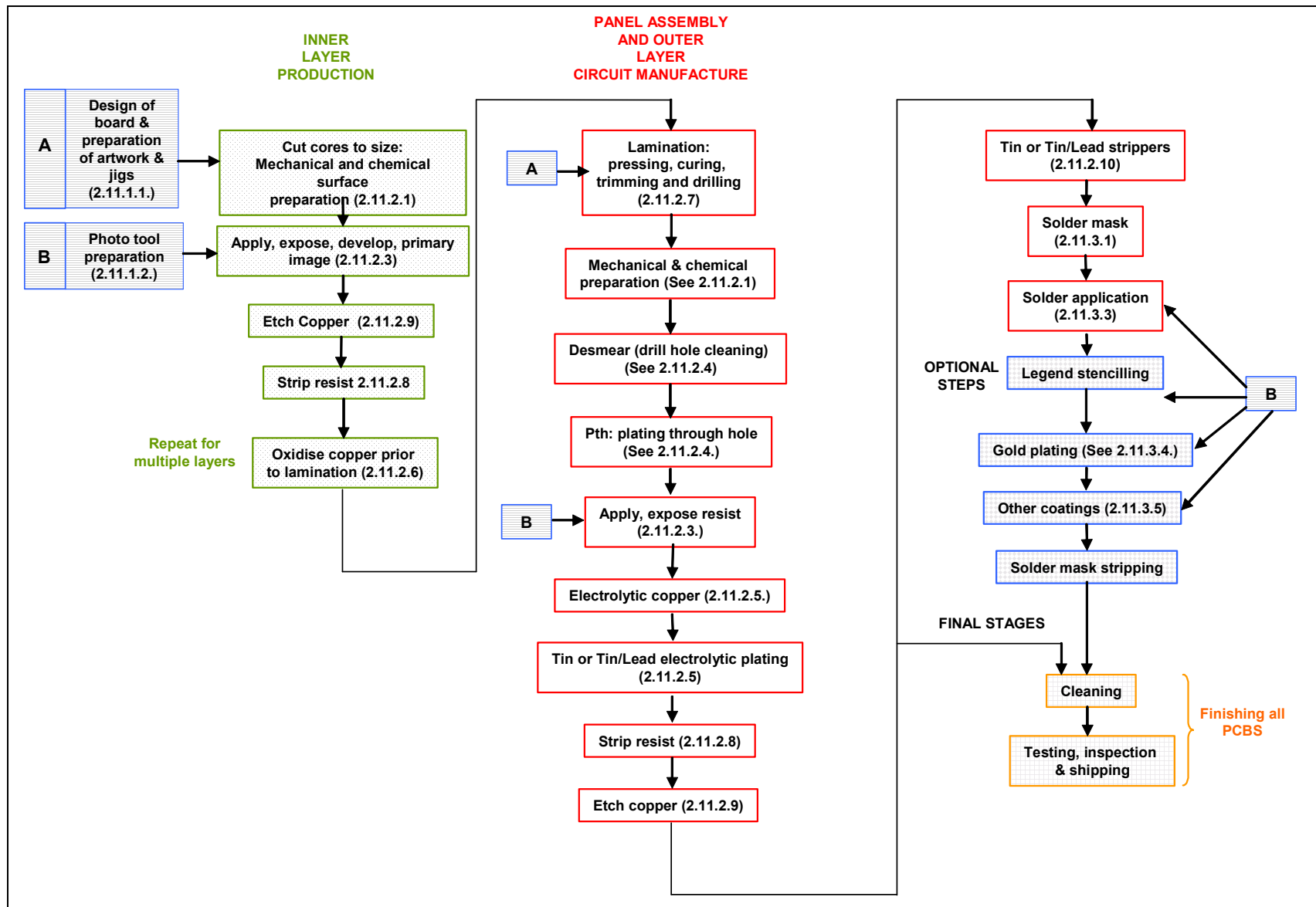

Figure 2.29: Flow diagram of typical printed circuit board production process sequence

2.11.1 Preparatory operations

2.11.1.1 Design of board

The printed circuit design is normally developed on CAD software, including reference marks such as locating holes for jigs to hold the board during the various processes such as drilling. The design is transferred to an artwork template called a phototool.

Environmental considerations

Removing large areas of copper slows production, wastes etchant and increases waste and copper concentration in effluents. Also, a PCB etches more consistently if all regions of the board have the same ratio of copper to bare substrate. Therefore designs may widen connects, leave unconnected copper in place, or leave large areas of board covered with arrays of small, electrically isolated copper diamonds or squares [139, Wikipedia, 2004].

2.11.1.2 Generation of phototools (photo lab)

There are two ways of applying a design to a PCB: screen printing or photo-printing. Phototools are used in both processes and are made of polyester, or, for extremely high dimensional stability and accuracy, glass. The images are either dia positive (the tracking is shown as a positive image) or dia negative (the tracking is shown as a negative image). The phototools are coated with silver-halide emulsion produced by two techniques, although the photo technique or photo plotting have largely replaced screen printing technology.

Photo plotting uses laser plotters with high resolution to trace the design onto the film with an accuracy of up to 15 μm for trace and space. A development and fixation process follows in a continuous horizontal line.

Environmental considerations

To use as much of the raw laminate as possible, multiple sets of small designs are generated on the phototool by repeat processes. This will result in multiple images on each laminate panel processed.

Film generation: due to the silver content, revenues can be generated of wastes originating from films and developer solutions. Diazofilms, however, are disposed of, as they are not suited for recycling. Alternative processes, such as direct imaging, are not commercially viable.

When using the screen printing process sodium hydroxide solution, aldehydes, dispersions of polyvinyl alcohols, toluene and xylene may be discharged into the effluents.

2.11.1.3 Screen printing

Screen printing is based on the well-known printing technique [90, EIPPCB,]. An ink-permeable screen is stretched on a frame, degreased, rinsed and dried. A photo-sensitive emulsion based on a silver halide and polyvinyl alcohol/acetate is applied and dried. The film is cured with ammonium hydrogen dichromate. The image is applied and developed. If the screens are used again, they are cleaned by an oxidative cleaning process using stripping solutions such as enzymes, sodium hypochlorite, and periodate. Residues may be removed using toluene, xylene or butyl acetate.

Due to higher resolution requirements for the track pattern, the screen printing process is increasingly losing its importance against the photo printing process.

Environmental considerations

Wastes cannot be recovered.

Water-based effluents may be treated if necessary.

Solvents may be used in cleaning the screens.

2.11.2 Production steps**2.11.2.1 Mechanical and chemical preparation****Cut laminates to size**

Prior to the application of the photoresist (see Section 2.11.2.3), the blank laminate has to be cut or punched to size and shape, and preliminary holes drilled for locating and initial contact through the board, see board design, Section 2.11.1.1.

The laminate is cleaned to remove the corroded copper surface. A pre-cleaning process provides a clean face for subsequent treatments (as in Section 2.3.4), but for PCBs a level surface is also essential for the high-accuracy circuitry. The cleaning processes are typically set up sequentially in horizontal continuous production lines.

Cleaning

The copper surface is initially cleaned with NaOH or a mixture of tensides and acids (H_3PO_4). This is followed by three further processes [159, TWG, 2004]:

- **Brushing**

Brushing stations then roughen the board surface with roller brushes of bristles or non-woven abrasives under a water spray to wash away the abraded copper. Bristles can also be nickel silver or bronze. Problems caused by uneven wear can be overcome by oscillating rollers. The surface roughness should be between 1.5 and 2.5 μm . The subsequent adhesion of dry or liquid resists depends on the number of grooves and pores per surface unit.

The surface is subsequently cleaned (usually on a conveyor system) by spraying in a rinsing cascade (see Section 4.7).

- **Abrasion**

An inert pumice slurry (SiO_2 72.0 %, Al_2O_3 13.0 %, K_2O 4.2 %, Na_2O 3.5 % (unknown 7.3 %) is sprayed at high pressure to restructure the copper surface to a surface roughness of $R_z = 1.6$ to 1.9 μm , rather than to remove copper. Following this treatment the surface is rinsed under high pressure (10 bar) and subsequently dried.

- **Chemical roughening or microetching**

This is spray etching using either copper chloride or a pickle of an acidic sodium persulphate, and for very thin inner cores, is the preferred method, as no mechanical damage of the cores should occur. The persulphate pickle consists of approximately 100 ml/l sulphuric acid and between 70 and 120 g/l sodium persulphate. During the microetch process, the copper value rises continuously. The performance of the etchant is reduced as soon as the concentration exceeds a value of approximately 30 g/l and the solution has to be prepared afresh. During a batch process, the concentrate is either precipitated as copper hydroxide slurry in an alkaline solution, pressed out and discarded as waste, or is recycled electrolytically.

The surface is rinsed in a cascade followed by a drying process.

Excess water is removed from the boards by squeegee rollers, and then residual humidity is evaporated by an almost pressureless preheated airflow.

Environmental considerations

The effluent from the rinsing cascade may be treated through an in-line neutralisation module prior to discharge.

Copper may be mechanically recovered by centrifuging or filtration, and this, coupled with cascade rinsing, can enable recycling of the waste water, and near-closed circuit operation of rinsing.

Where effluents are discharged, they can be treated in a typical waste water treatment plant. However, it is important to remove as much particulate copper as possible at source, as the copper can readily dissolve. If dissolved in acid solutions, it requires neutralisation, flocculation and precipitation; if complexed, it can be more difficult to treat (see Section 2.13.1.1).

Laminate and PCB wastes and off-cuts can be collected by specialist companies for recycling of the metals.

2.11.2.2 Drilling

In modern high density boards, holes are to be drilled as small as possible, often below 0.5 mm. NC controlled single spindle machines are used, but are increasingly replaced by the CNC/DNC controlled multi-spindle machines, as well as laser and the X-ray drilling machines used to generate very high hole densities for HDI technology.

Multi-spindle CNC drilling machines have table constructions which are extremely warp-resistant, relatively light and in addition fast to accelerate and to position. Spindles with air bearings can achieve more than 100000 rpm with individually controlled Z-axis modules.

Environmental considerations

The compressors and air drives produce noise, often at high frequencies. Modern drilling machines are usually contained in cabinets to reduce noise and maintain clean room working conditions.

Wear resistant tungsten carbide drill bits are breakage resistant, and can be resharpened, achieving high drill counts.

The swarf from drilling and routing is only generated in small quantities and cannot be recycled as the metal content is too low.

Entry boards made of aluminium which are commonly used and drills (for which resharpening no longer is possible) can be recycled 100 %. Drill-back boards are either disposed of or returned to the manufacturer. Dusts generated in drilling and routing operations with a remaining content of metals between 10 and 25 % are disposed of as wastes.

2.11.2.3 Generation of the primary image

There are two types of photoresist (or resist) used to produce the track image including the reference marks on the laminates from the phototools (see Figure 2.27):

- liquid resist applied by roller coating
- dry resist applied by lamination.

Inner layers for MLBs may be either structured by screen printing or by dry resist (dry film). The pattern of the outer layers is generally structured by dry resist. In isolated cases, a third process, screen printing, may be used. For photo-printing the three process steps are coating (liquid or dry), exposure and developing. These process steps may be automated and conducted in a continuous process.

Coating

During the first step, the pretreated surface is coated with a photosensitive layer (photo resist) which is available either as liquid resist or as dry resist. For the coating, two different important processes are available: roller coating for liquid resists and lamination for dry resists. Table 2.3 shows the advantages and the disadvantages of both systems

Process	Advantages	Disadvantages
Roller-coating (liquid resist)	Low film thickness (approximately 2 - 12 μm)	Risk of pinhole formation
	Lower pollution in effluents due to lower material usage	Contain more than 50 % VOC-based solvents which may require reduction under Solvent Emissions Directive
	High yield from material used	Potential problems during ultrafiltration of effluents from developer and stripper
	Lower investment	Higher energy requirement
	Low under-etching of copper	Risk of involuntary bonding of inner layers
Lamination (dry resist)	Constant coating thickness because of dry film	Film thickness is generally 37.5 μm , more resist removed creating more effluents and resist waste
	No pinholes	Higher investment
	Low energy consumption as no drier is needed	
	No VOC emissions	

Table 2.3: Comparison of resist layer types for primary imaging [122, UBA, 2003]

- Roller coating (liquid resist). The liquid resist consists of acrylates, photo-initiators and fillers and is dispensed through a metering gap and spread under pressure by a corrugated rubber roller onto the surface of the laminate. Because of the corrugation of the roller, the contact pressure and the solid content of the liquid resist, the coating thickness is adjusted to a thickness of between 2 to 12 μm . The resist is continuously filtered and monitored in its viscosity while being circulated through a storage tank. The condition of the rollers is important as damaged rollers produce defective coatings. The inner layers are coated on both sides and then dried with on-line infrared driers. The conveyor speed is about 2 – 4 m/min with a high yield from the liquid resist. Material losses occur only during the cleaning of the equipment or when changing the resist
- Lamination (dry resist) (Figure 2.30). Dry resists are structured in several layers. In clean room conditions with only yellow light, the photo sensible emulsion is applied by curtain coating on a polyester carrier foil of 25 μm thickness, dried and covered with a polyethylene protective layer. This sandwich can be rolled onto a paper or a plastic roll core from which it is laminated to the surface of the inner layer. Either manual or fully automatic laminators are used, the centre core of which is the roller system. Principal factors influencing the process are: laminating rollers with an aluminium core to maintain dimensional stability, temperature, contact pressure, waviness of the laminate surface, laminating speed and the pretreatment method of the copper surface

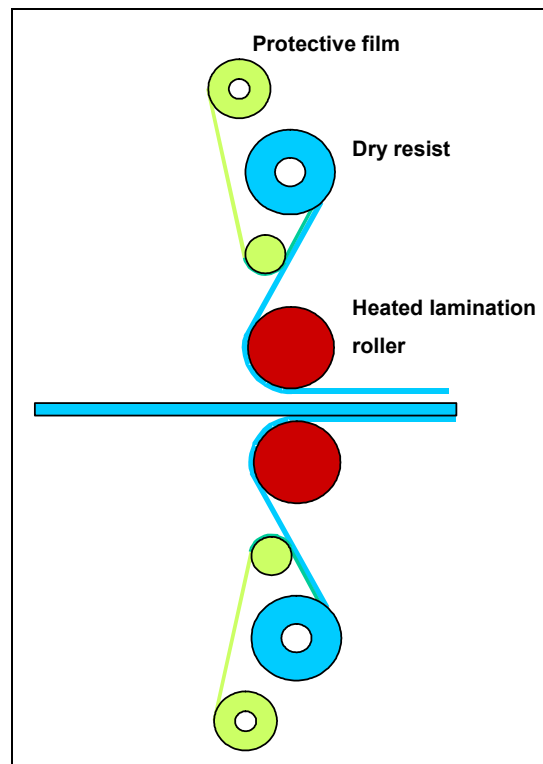

Figure 2.30: Application of dry resist

Exposure

The image is photo-printed onto either type of photoresist– either manually or automatically - in imaging equipment in clean rooms under amber light conditions. In Figure 2.30, the phototool (see Section 2.11.2.3) is exposed to UV light which passes through the transparent areas of the phototool, and polymerises the monomer components of the resist by cross-linking. The resulting polymer is resistant to the following development process.

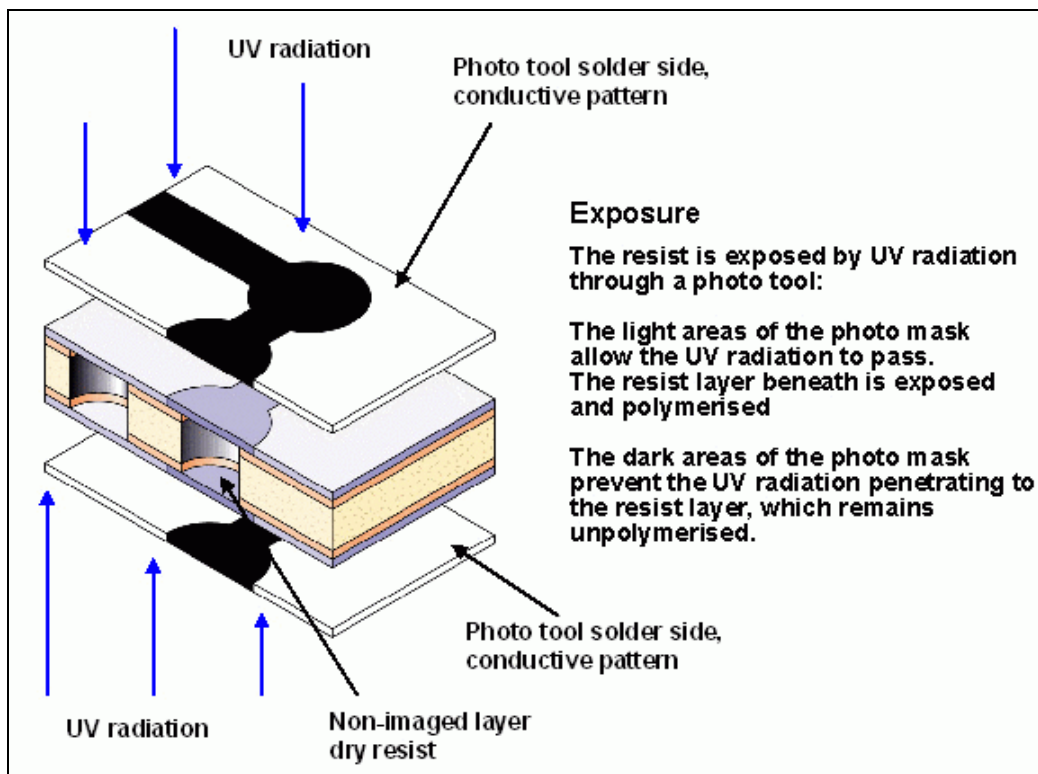

Figure 2.31: Exposure of resist

Developing

The laminate (resist) is developed by spraying with a sodium carbonate solution while passing along horizontal continuous line. This step exposes the final track pattern (tracks, pads with holes, pads for SMDs (surface mount device) and ground planes for the following process (Figure 2.32).

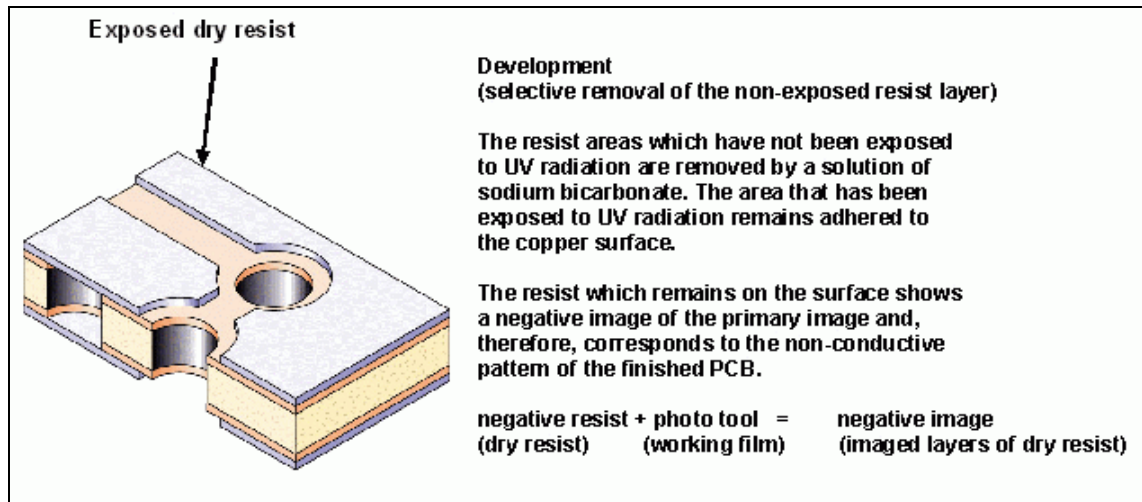

Figure 2.32: Development of resist

The typical development line consists of the main development chamber, followed by a smaller chamber(s) with fresh sodium carbonate supply. This enables the panel surface to be rinsed with clean development solution, reducing the drag-out of contaminated solution into the following fresh water rinsing zone. The development chamber may be equipped for the first 60 % with cone nozzles and for the remainder with fan jet nozzles. The manifolds are equipped with an oscillation to bridge the mechanical effect of the spray nozzles and a better exchange of solution. The fan jet nozzles are to be installed at an angle of approximately 30 - 40° transverse to the direction of the process. In case of multiple nozzle bars, these may be installed against each other.

Screen printing process

In isolated cases non-pth PCBs are still manufactured using screen printing technology. The copper surface of the panel is coated with a special ink applied through a screen, described in Section 2.11.1.3. The exposed copper surfaces will be removed during the following etching process. The pattern is finished; although further processing with solder mask can follow (see Section 2.11.2.11). Screen printing inks may be removed either by solvents or sodium hydroxide solution.

Environmental considerations

Table 2.3 sets out the advantages and disadvantages of the two layer coating techniques.

Liquid resists contains more than 50 % solvents that evaporate causing VOC emissions, which may require reduction by the Solvent Emission Directive [97, EC, 1999, TWG, 2004 #159]

The exposure stage generates no waste or waste water. Cooling water can be recirculated. The development stage can use successive static rinses of developer to reduce drag-out, and use of fresh rinsing water (see Section 4.7).

Removed resist can be filtered from the effluent from the developer stage.

Screen printing inks that have to be removed (stripped) by halogenated solvents can now be substituted by alternatives.

Process tanks are usually equipped with fume extraction and scrubbing to remove generated aerosols.

Waste water s may need treatment including neutralisation and settlement.

Packing and protection of dry resists generates significant volumes of waste. Different types of plastic are used, making separation and return difficult. Some material may be separated and returned for recycling. Due to the elaborate packing requirements, a return to the suppliers is generally not possible. It is possible to minimise the incurring wastes by using liquid resists for inner layers.

2.11.2.4 Plating through holes (pth, through hole plating)

Plating through the holes provides electrically conductive connections between the conductor tracking planes on both sides of a double sided board or between the multiple tracking planes of MLBs. There are usually three stages, desmearing, activation and electroless (autocatalytic) copper plating. However, there is a tendency to replace autocatalytic copper by direct plating (see environmental considerations at the end of this section).

Note: do not confuse this process with through hole construction, which is a type of PCB construction where the wires of components are placed through holes drilled through the board. This has now largely been superseded by surface mounted components.

Desmearing - removal of the smear film

The high drilling and advance speeds cause the drill bits to heat up, causing the drilled polymer residues to smear as films in the barrel of the holes. It is essential to remove these residues or there will be poor adhesion of the metal layer to be deposited. Remaining residues may also lead to later problems by vaporising during the soldering process (out-gassing).

The desmear process is best accomplished by using either potassium or sodium permanganate in several working steps:

- degreasing with phosphoric acid
- deburring with abrasive rollers
- swelling with sodium hydroxide, butyl diglycol and additives
- permanganate process with permanganate and sodium hydroxide
- cleaning process with hydrogen peroxide to prevent undesirable reoxidation.

The etch-back process using concentrated sulphuric acid (96 %) is being superseded by the permanganate process.

A plasma etch process exists but is rarely used.

Environmental considerations

Autocatalytic copper baths have a limited lifetime before they require complete replacement. Disposal of the baths is difficult (see Section 2.5.8). They are difficult to use, inherently unstable and use formaldehyde and complexing agents including EDTA, which are carried over in waste waters. While autocatalytic copper, especially with EDTA, was being replaced by 'direct plating', the high technical standards required for modern HDIs has led to a resurgence in the use both of the autocatalytic process and the use of EDTA. However, the use of direct plating is increasing again, and about 60 % of the autocatalytic copper baths have been replaced by direct plating [122, UBA, 2003].

Desmearing has used chromium salts. However, they can now be substituted with potassium or sodium permanganate (see the direct plating process description in the paragraph above).

The direct plating baths containing complexing agents have to be batch treated or segregated and treated separately. Rinse-waters containing palladium are treated to extract the metal. The rinsing water can be countercurrent cascade (see rinsing, Section 4.7). After dealing with the complexing agents, effluent may be treated in a typical waste water treatment plant. The hydroxide sludge may be recycled as it has a high metals content (see Section 4.17).

2.11.2.5 Electroplating of conductive pattern

Following the structuring process of the primary image, electroplating processes are used for:

- build-up (increasing of layer thickness) of conducting structures (primary image)
- protection of a copper surface against the etching medium (etch resist)
- plating of contact fingers with precious metals.

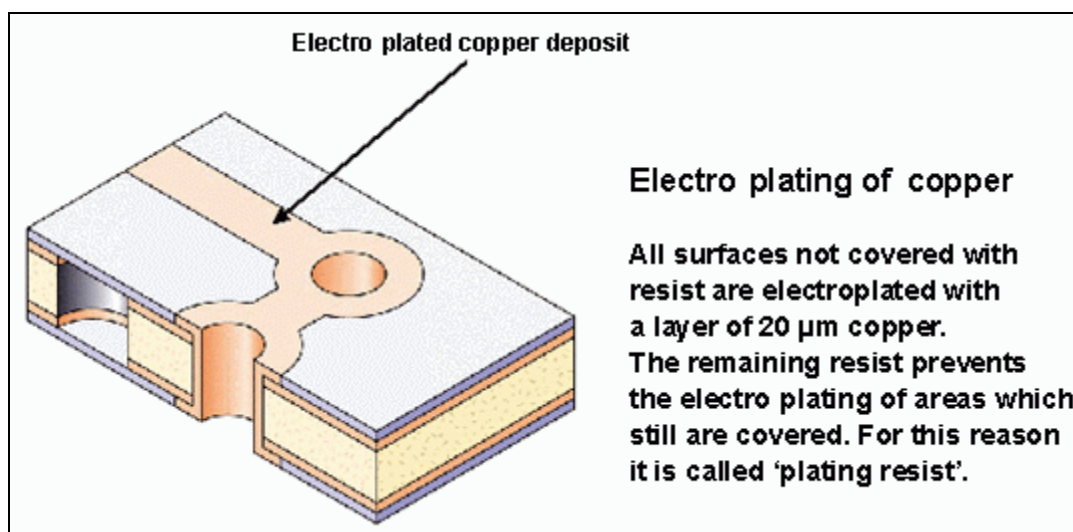

Figure 2.33: Copper electroplating

Pre-cleaning, deoxidation and acid

The panels that so far have been processed either by screen or by photo printing are now treated to eliminate any residues of grease, finger prints, etc.(see Section 2.3) They are first pre-cleaned in acidic, in alkaline or in neutral solutions. The open copper surface (conductive pattern) is then deoxidised either with sodium persulphate solutions or sulphuric acid/hydrogen peroxide solutions. Between 0.5 and 1 µm copper are removed. The copper surface is finally acid dipped to provide a freshly activated surface for plating.

Electrolytic deposition of copper

Generally, the primary image is built up by a minimum of 20 μm on top of the base copper surface where the surface is not protected by the plating resist, see Figure 2.33 (proportionately less within the barrel of the holes). For details, see Section 2.5.1

Etch resist – tin electroplating

In order to protect the electroplated primary image against the attack of etching media the copper surface is covered with a tin layer (Figure 2.34), described in Section 2.5.6.

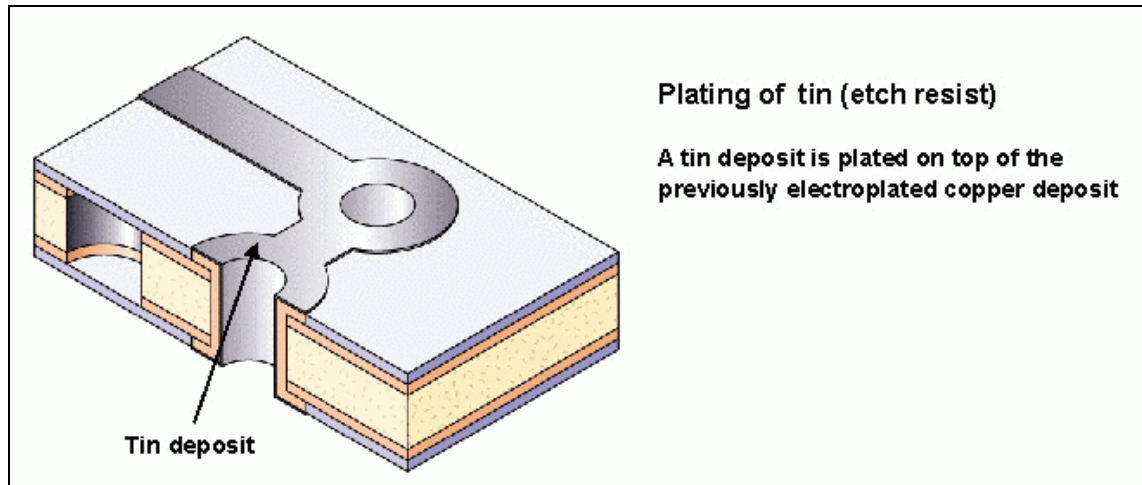

Figure 2.34: Tin electroplating

Electroplating with gold or other precious metals

Contact fingers for plug connectors are frequently gold plated. In rare cases, they are finished with rhodium, ruthenium or palladium. See Section 2.5.7.

Environmental considerations

Electrolytes for etch resists were generally based on lead- and tin fluoroborate solutions. Several Directives restrict the use of lead in products, and by 1 July 2006 lead additives in electroplating baths for PCB production will be removed to use 100 % tin depositions. (The Directives are:

- the End-of-Life Vehicles (ELV) Directive [99, EC, 2000]
- the Waste Electrical and Electronic Equipment (WEEE) Directive [96, EC, 2003] and
- the Directive on the Restriction and Use of Certain Hazardous Substances in Electrical and Electronic Equipment (ROHS Directive) [98, EC, 2003]).

In order to satisfy customer requirements for niche products (reflow boards) with 10 μm deposits of tin/lead (60/40 %) electrolytes are still used, but with reduced lead content.

The manufacturers of PCBs and their chemical suppliers are in a position to change to lead-free electrolytes rapidly.

Chemical coppering may be replaced by palladium, graphite or conducting copolymers, which are so-called 'clean technology' techniques.

To prevent deterioration of the workplace atmosphere, process tanks may be equipped with fume extraction to remove generated aerosols.

Effluents may require treatment in a waste water treatment plant. These treatments include filtering, neutralisation and settlement.

2.11.2.6 Inner layer bonding adhesion

Oxide processes have been commonly used and are described below. However, other processes are now emerging (sometimes referred to as oxide alternative treatments). One type creates a copper azole complex at the surface. Developments of these processes are rapid and driven by ever-increasing higher technical requirements [159, TWG, 2004].

The copper surface on inner layers is oxidised to Cu(I) to improve the adhesion between cores and prepregs and to prevent subsequent delamination (separation of multilayer boards). The oxide layer of 0.5 – 5 µm is formed by one of two processes:

- the brown oxide process is most commonly used and consists of hydrogen peroxide, organic additives (for passivation) and chloride (in mg quantities only), running at 30 °C
- the black oxide process is carried out in a solution of sodium phosphate (Na₃PO₄), sodium hydroxide (NaOH), and sodium chlorate (NaClO₂) or hypochlorite (NaOCl) at 80 °C.

Effluents can be minimised by ensuring the concentration of the individual components is maintained by additions equalling the evaporation rate.

Thorough rinsing is necessary after the process (see Section 2.4)

Environmental considerations

The brown oxide process is increasingly used as it runs at lower temperatures and does not use chlorate or hypochlorite.

The process may need air extraction.

Effluents can be minimised (see above) and treated in a typical waste water treatment plant.

A new bath is made up at approximately 24 months intervals, and can be discarded after batch treatment by alkaline precipitation.

Oxide alternative treatments reduce consumptions of chemicals and water and generation of waste.

2.11.2.7 Lamination

Both the laminates and the insulating layers (the prepregs) have to be bonded strongly and using oxidised copper surfaces (see Section 2.11.2.6) prevents delamination of the finished board. The pre-oxidised cores of the multilayer are laminated with bonding sheets (prepregs) and copper foils (outer layers), see Figure 2.35.

The prepregs are shaped sheets of pre-polymerised epoxy resin reinforced with glass fibre. They liquefy under the influence of pressure and temperature and bond with the inner cores.

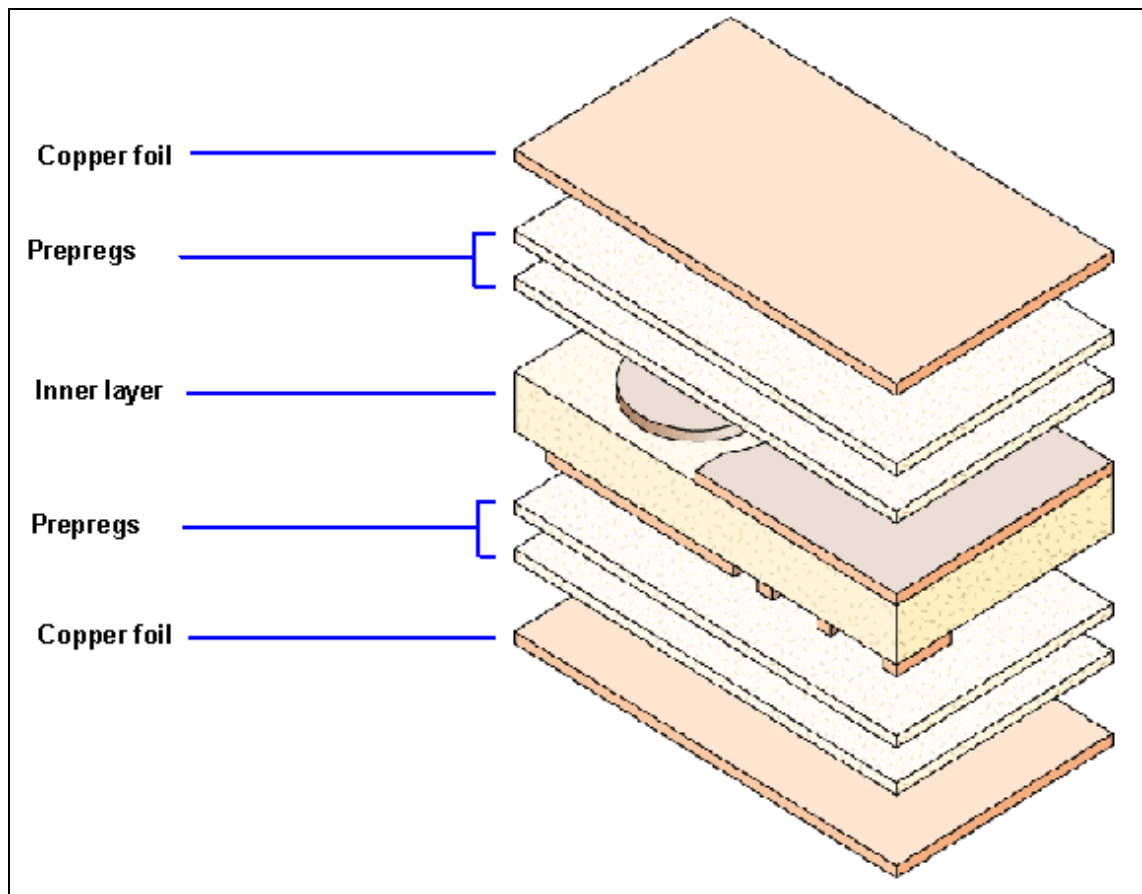

Figure 2.35: Schematic of a multilayer board

The principal working steps for the lamination process are:

- lay up (registration) in the lay-up station
- lamination in a vacuum press
- destacking of the lamination tool
- trimming of the flash on the rim of the MLB.

Environmental considerations

Offcuts from laminating and trimming can be recycled to recover the metals via specialist companies.

2.11.2.8 Resist stripping

After electroplating, the photoresist film has served its purpose of defining the circuit image and is, therefore, completely removed from the board surfaces (Figure 2.36).

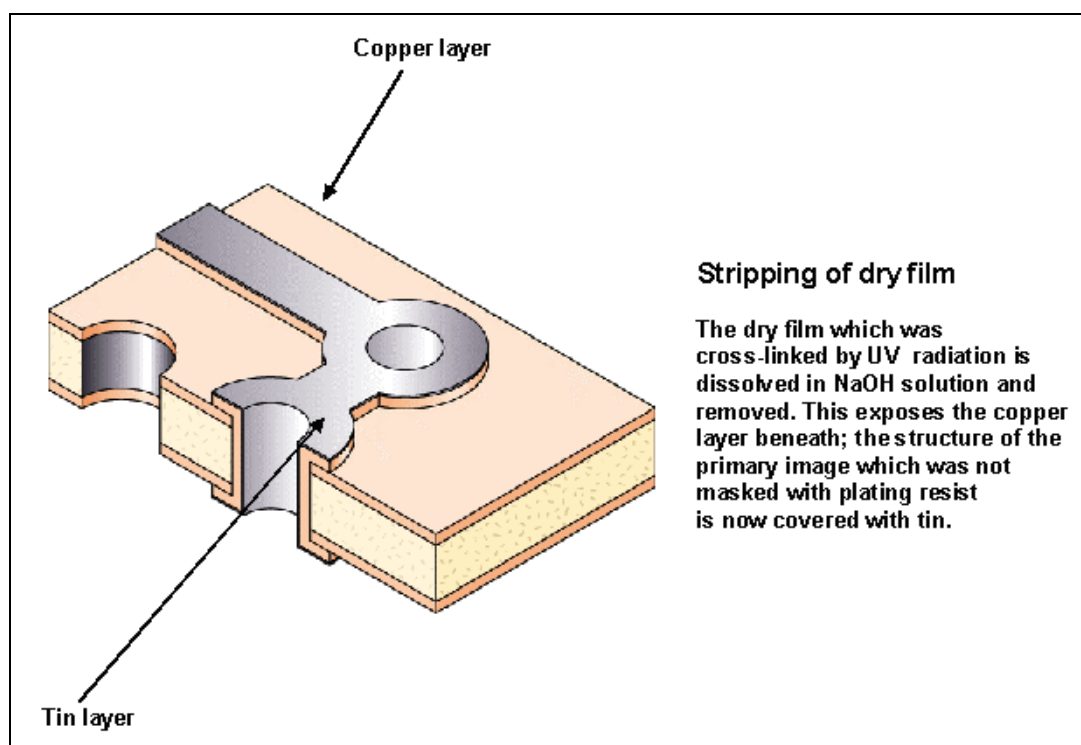

Figure 2.36: Stripping of dry film

Resist strippers are designed to strip fully both aqueous dry film and liquid photoresists. The resist strippers have been formulated in order to remove the resist rapidly without attacking the copper or the tin/tin-lead. Controlled swell characteristics minimise lock in between fine tracks.

- typical operating temperature 30 °C [159, TWG, 2004]
- dwell time approximately 60 - 120 seconds.
- solution dilute alkali (NaOH or KOH 10 - 20 g/l) with organic additives such as butyl glycol or butyl diglycol, although in Germany systems are often run without organic additives [159, TWG, 2004]

Environmental considerations

Copper emissions, and COD from the soluble organic additives.

The stripper breaks down the film into large particles, which are easily removed from the effluent by filtration. The effluent may be concentrated using filtration and evaporation, with distillate being sent to waste water treatment (for COD) and concentrate being managed as a hazardous waste.

To prevent deterioration of the workplace atmosphere, process tanks may be equipped with fume extraction to remove generated aerosols.

Waste waters may require treatment in a treatment plant. These treatments include filtering, neutralisation and settlement.

2.11.2.9 Etching

Etching is undertaken to completely remove the base copper thus leaving only the circuit pattern which is protected by the tin/tin-lead deposit (etch resist), see Figure 2.37. Typically, modern etchants will remove copper at 5 to 50 microns per minute at 50 °C.

The type of etchant used, the equipment in which it is used and the rate of etch is of great importance, as they all influence the amount of undercut that occurs. The undercut is where copper is dissolved from beneath the metal etch resist, producing an overhang of the metal resist.

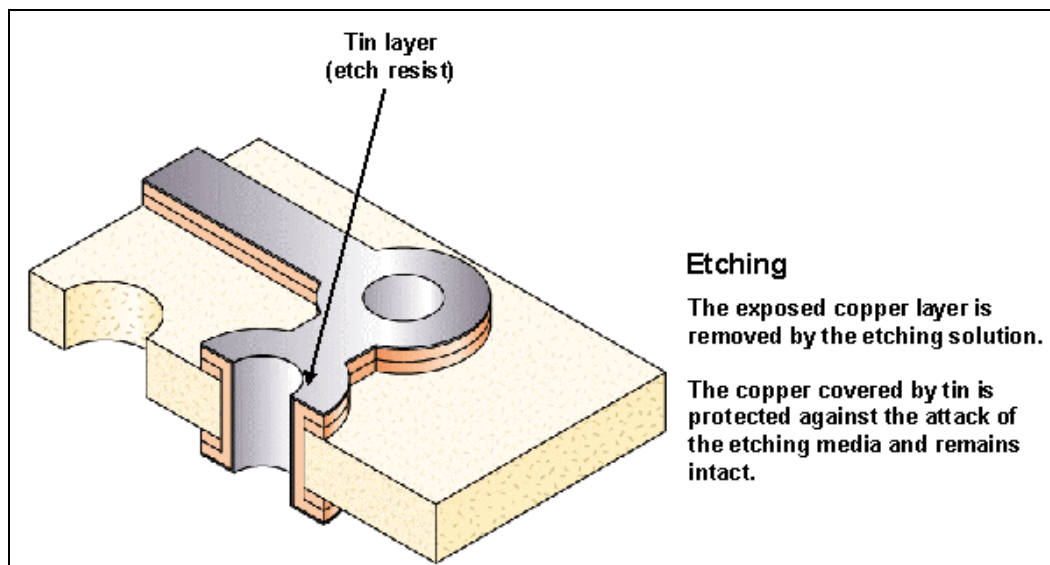

Figure 2.37: Etching

The following etchants are in use:

- ammoniacal etchants: ammonium salts (chloride, sulphate, carbonate): PCBs that have been made resistant by deposited metals, i.e. tin (metal-resist technology) are almost exclusively used in this process, and it is frequently used. Atmospheric oxygen acts as an oxidising agent
- acidic etchants: copper(II) chloride solution used as a starter solution (approximately 30 g/l Cu), attacks metallic copper in the presence of HCl and forms copper (I) chloride (CuCl). In the presence of hydrochloric acid (200 – 240 mg/l) and hydrogen peroxide, the inactive copper (I) is oxidised to copper (II). It is used for inner layer etching, single-sided, double-sided and multilayer non-ptb boards
- hydrogen peroxide/sulphuric acid are used for micro-etching and as a replacement for persulphate sulphuric acid
- acidic, ferric chloride (FeCl₃) is now rarely used.

Etching is performed predominantly in horizontal in-line installations. Those PCBs that have been made resistant by deposited metals, i.e. tin (metal-resist technology), subsequently are almost exclusively processed in ammoniacal etchants. The bases are ammonia compounds like ammonium chloride, ammonium sulphate and ammonium carbonate. Aerial oxygen serves as oxidation agent. The etching solution has the following parameters [159, TWG, 2004]:

- pH: 8.0 - 9.5
- temperature: 20 - 45 °C.
- copper: 145 - 170 g/l
- halide: 235 - 265 g/l; content of chloride 4 – 4.5 mol/l
- redox potential: about 600 mV.

Ventilation is likely to be required to remove ammonia and achieve a comfortable work environment, as well as meeting health and safety requirements. A controlled balance is necessary. Excessive ventilation will reduce pH and ammonia levels; insufficient ventilation will allow excessive fumes and an increase in pH and ammonia. Ideally, the ventilation should be dedicated to the etch line only.

Environmental considerations

Processes are available to recover significant amounts of copper and minimise etchant top up as well as storage and transport of hazardous solutions.

Where ammonia etchant is used, process tanks may be equipped with fume extraction to remove generated aerosols and fumes to maintain the workplace atmosphere within health and safety levels. Fume extraction may require scrubbing, which will increase ammonia levels in the effluent.

Effluents may require separate treatment prior to a typical waste water treatment plant, depending on etchant chemistry.

Etching solutions are generally returned to suppliers or external companies for processing. This involves exchanging used bath solutions for new ones, with handling and storage. Internal reprocessing may be possible with additional recycling modules.

Acidic etching solutions: generated concentrates in the acidic etching process (hydrochloric acid, copper chloride and hydrogen peroxide) are recycled by external suppliers or contractors. By optimum management of all parameters and by enriching the copper, these wastes can be sold. The regenerated hydrochloric acid can be re-used in the process. Other methods of recycling have not proven to be successful.

Ammonia etching solutions: processes are available to recover significant amounts of copper and minimise etchant top-up as well as storage and transport of hazardous solutions, see Section 4.15.7.

2.11.2.10 Tin stripping

This process is now typically undertaken in a horizontal mode as a two-stage tin lead stripping technique. The first stage strips to the intermetallic layer, then the second stage strips the intermetallic layer thus leaving a blemish-free copper surface. Hydrogen tetrafluoroborate, tin fluoroborate or nitric acid solutions are used:

- stage 1: temperature and immersion time 25 – 35 °C for 20 – 60 seconds
- stage 2: temperature and immersion time 25 – 35 °C for 10 – 30 seconds.

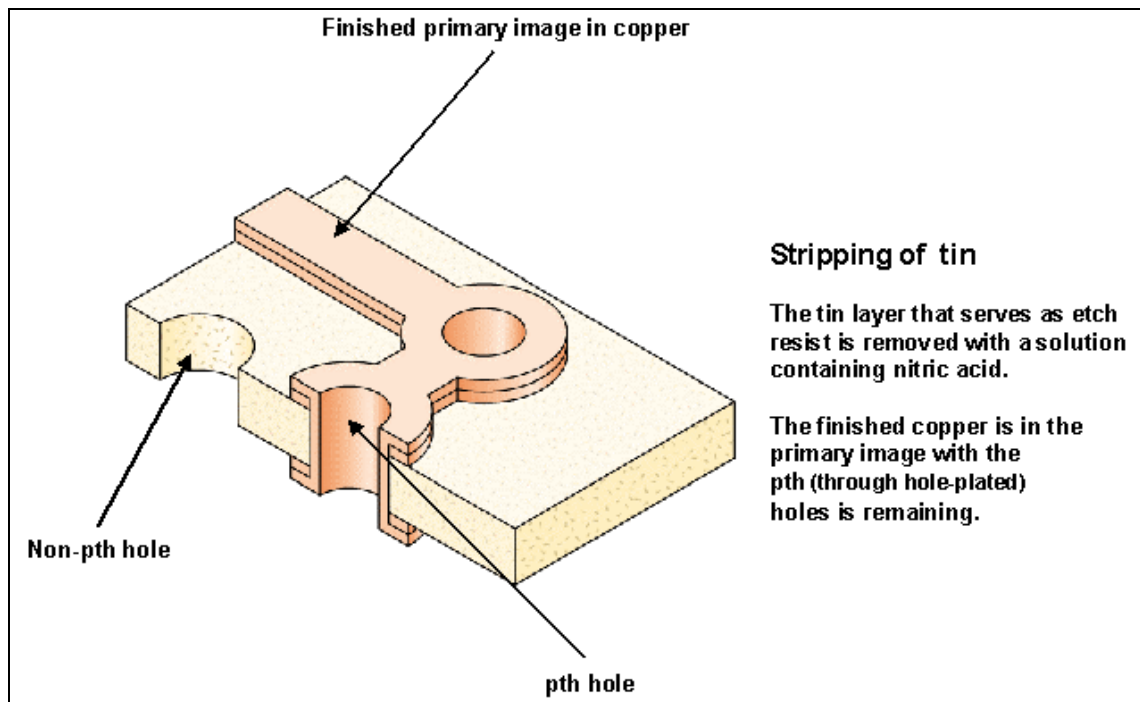

Figure 2.38: Stripping of tin resist

Environmental considerations

To prevent deterioration of the workplace atmosphere, process tanks may be equipped with fume extraction to remove generated aerosols.

Waste waters may require treatment in a treatment plant. These treatments include filtering, neutralisation and settlement. Internal reprocessing has not proven effective for the quantity of metal recovered.

2.11.2.11 Application of solder mask

After the stripping of the etch resist, the unprotected copper surfaces on the PCBs needs protection from corrosion, and from solder bridging (solder making unwanted connections between tracks) during the soldering process when components are added to the board. All copper portions which are not required in the assembly process are covered with an insulating resin matrix (see Figure 2.39 and Figure 2.40). Several methods are available, the most important ones being screen printing and curtain coating.

Screen printing is described in Section 2.11.1.3. The difference here is that a solder mask is applied. However, this technique is not normally used for high volume production.

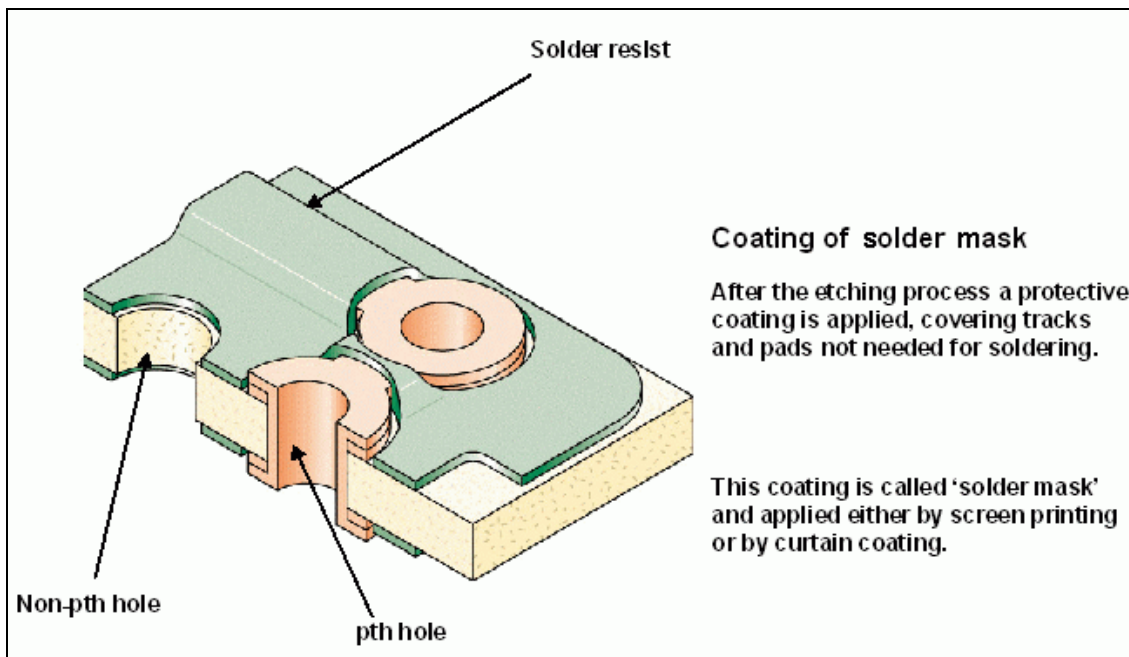

Figure 2.39: Coating with solder mask

Curtain coating is more efficient and used for high production volumes. The panels are passed on a horizontal belt (at approximately 20 m/min) through a curtain of solder mask. After it is tack cured it is exposed through a photo stencil (similarly to etch resist, see Section 2.11.2.5). As in developing etch resist, the non-exposed surfaces are selectively stripped in a developer solution of sodium carbonate or ethyl glycol: aqueous alkaline masks are increasingly used. The panels are then rinsed, dried and cured in line, see Figure 2.39.

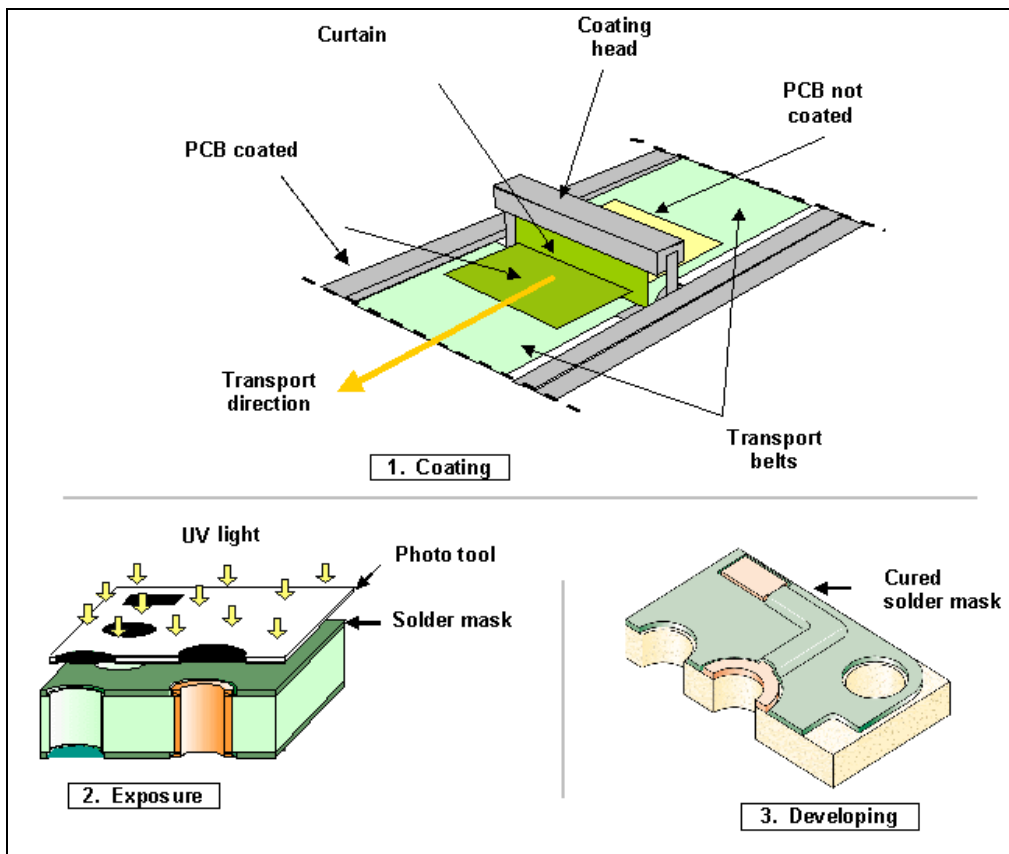

Figure 2.40: Curtain application by and curing of solder mask

Environmental considerations

Residues originating from developing photosensitive inks and masks are disposed of. The containers in which lacquers have been supplied may still have residues of their contents after emptying. These containers may be collected for recycling.

2.11.3 Additional surface finishing activities

There are several surface finishes: Hot Air Solder Level (HASL), Organic Solderability Preservative (OSP), Electroless Nickel Immersion Gold (ENIG), Immersion Silver (ImmAg), Immersion Tin (ImmSn), Reflowed Tin/Lead, Electrolytic Nickel Gold, and Electroless Palladium. Some of these are described below and in Sections 2.5.7 and 2.5.9. The selection of which steps are applied depends on specifications and subsequent process requirements.. As this industry develops rapidly, further information can be found on industry websites. [159, TWG, 2004].

The application of a solder mask leaves areas (called pads and lands) for the surface mounting of components. These surfaces need protecting, usually by Ni/Au, if the soldering of components is not carried out immediately.

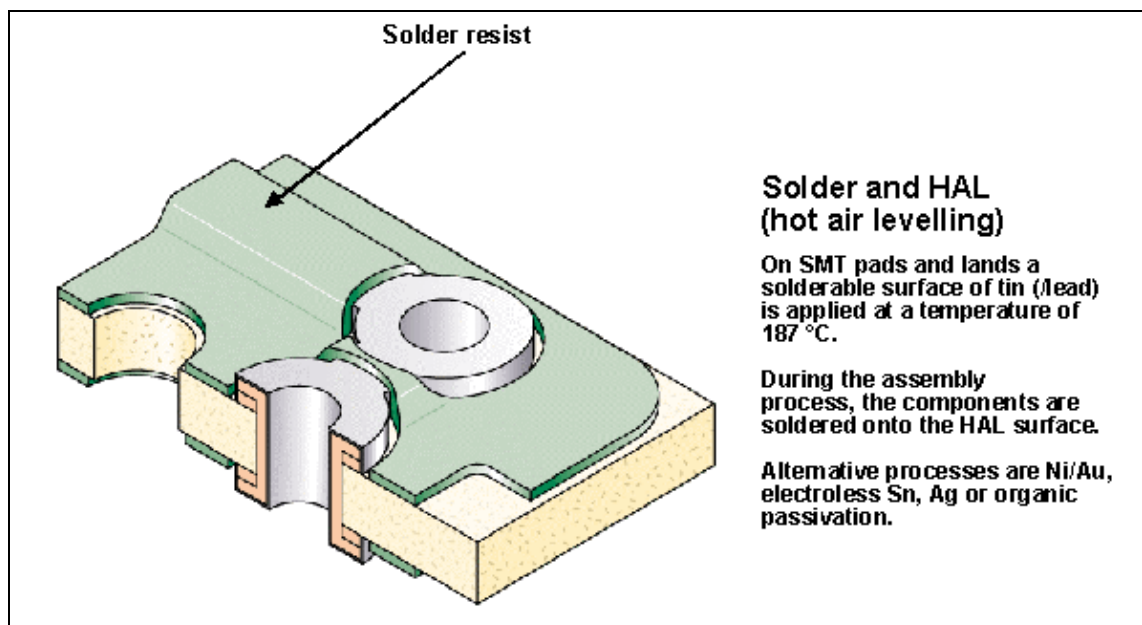

Figure 2.41 Hot air levelling

2.11.3.1 Solder application

This is also called Hot Air Leveling (HAL) or Hot Air Solder Leveling (HASL). After pre-cleaning (degreasing, deoxidation and drying), the boards are immersed in a flux (rosin) bath, followed by dipping in a eutectic tin-lead bath at approximately 240 °C. The molten tin-lead is blown out of the holes under high pressure. This hot air knife levels the tin-lead deposit, with a thickness of about 1 – 25 µm., as in Figure 2.41. The boards are rinsed and dried.

Environmental considerations

Rinsing produces effluents containing thermally cracked fluxes and therefore has a chemical oxygen demand.

Fume extraction may be required.

The replacement of tin-lead solder used in the HAL process will be finalised by 1 July 2006 to meet the requirements of the ELV Directive [99, EC, 2000] and the ROHS Directive [98, EC, 2003]. Alternatives are either lead-free solders or electroless plating of tin, nickel/gold or organic substances, which protect the metallic copper of tracks and holes from dirt and oxidation and maintain their solderability.

The resulting dross and solder has a commercial value and is returned to the suppliers for external processing.

2.11.3.2 Nickel gold and/or tin

After surface preparation, a layer of electroless nickel is applied (see Section 2.5.8), followed by an immersion gold coating (see Section 2.5.9) [159, TWG, 2004].

Environmental considerations

Precious metals can be recovered.

2.11.3.3 Organic passivation

Organic passivations are increasingly used on horizontal moving lines. A protective layer of 0.2 – 0.3 μm is deposited out of a solution of acetic acid, imidazole derivatives and ammonium compounds. This layer is removed by a flux immediately prior to the soldering process.

Environmental considerations

Rinsing waters and concentrates can be treated in a waste water treatment plant. Prior separation and/or treatment may be required to prevent complexes being formed with metals.

2.11.3.4 Other activities – Stripping (de-metallising) racks and plating baskets

The plating racks and plating baskets must be regularly stripped of metal build-up (see Section 2.3.9). Carriers used in electroless copper plating are usually stripped in sodium persulphate solutions. Metal carriers which have been electroplated with copper and tin are stripped chemically, very often with nitric acid or in an anodic process.

2.12 Utility inputs

The utilities used in surface treatment include natural gas, propane gas and/or liquefied propane gas (LPG), fuel oil, coal, electricity and water [128, Portugal, 2003].

2.12.1 Energy

The energy uses are described in Section 1.4.3. Electricity is used in the form of direct current for the electrochemical processes. Gas, oil, coal and/or electricity can be used for process heating, depending on availability and cost.

Electricity is also used for process cooling and fume extraction. Gas and/or electricity are used for the drying of surface treated work.

The range of the typical proportion of energy consumptions per usage for a sub-contract acid zinc plating shop are:

- direct current for pretreatment and zinc plating 20 – 40 %
- process heating for pretreatment and zinc plating 20 – 40 %
- process cooling for zinc plating 0 – 17 %
- fume extraction 5 – 13 %
- drive motors, drying, space heating, lighting 13 – 40 %.

2.12.1.1 Electricity

Energy can be drawn from three-phase supplies and/or stepping down from high voltage supplies. These AC supplies are rectified to DC power for the electrochemical reactions within the installation via a system of bus bars (usually aluminium or copper) between the rectifiers and the anodes. There can be significant energy losses associated with these activities which are highlighted in Section 1.4.3.

The electrical power consumption in the electrochemical reaction per m² of surface treated in the process can vary according to the process chemistry. Some processes, such as acid zinc are more power efficient than others (such as cyanide zinc) where energy is lost in electrochemical side reactions (in this case, the oxidation of cyanide).

2.12.1.2 Fossil fuels and process heating

Many of the process vats have to be heated above ambient temperatures to operate efficiently. Oil and gas (and possibly in some cases, coal) are used as the main heating sources for process solution. Vats are often indirectly heated by a hot liquid circulating through heating coils. High pressure hot water systems (where the water can be circulated under pressure and at temperatures above 100 °C), and thermal fluid systems (oils which can also be run at temperatures above 100 °C) can provide a greater energy input for the space used, and may be required where process operating temperatures are close to 100 °C. Unpressurised hot water can be used where process temperatures are below 85 °C.

Leakages from water-based systems do not usually damage process solutions, but may dilute solutions beyond economic recovery. Thermal fluid leaks can require the complete replacement of process solutions, but are more easily observed.

Burners may be installed to heat tanks directly [128, Portugal, 2003]. Individual electric tank (immersion) heaters are widely used for process lines with small tank volumes (such as precious metals, and reel to reel), and may be used in manually operated lines with larger tank volumes but low throughputs or to assist other systems to achieve operating temperatures.

Energy use depends on the operating temperature required for the process to operate efficiently and heat losses from the system.

In electrochemical processes, heat also comes from the passing of current through the solution, and some chemical processes may be exothermic.

2.12.1.3 Cooling of process solutions

Many processes need to be maintained within a temperature range for optimum efficiency of quality of treatment and minimising breakdown of process chemicals. They may require heat input before starting to process (such as after a shutdown period overnight), but current passed during the electrochemical reactions or some chemical reactions may heat the solution beyond the range required. More information is provided in [85, EIPPCB,]. There are three common systems used in surface treatment:

- the simplest cooling system is once-through with water running once through cooling coils in the vats and discharging the water to foul sewer or surface water: water may come from the town supply, a nearby river or a borehole extracting groundwater. Water may also be recycled from other uses in the installation (such as used rinse-water or treated effluent) before discharge. The water used may require treatment before use, such as filtration of river or groundwater. These systems have the highest water usage and will be one of the biggest uses of water in an installation
- in recirculating cooling tower systems, the cooling water is recycled constantly through a cooling tower. However, running the water over the cooling tower maintains a high dissolved oxygen level which can cause corrosion within the system and evaporation of water at the tower can cause the build-up of suspended solids. The recirculating water may therefore require treatment to prevent corrosion and some of the water must be discharged periodically to prevent build-up of excess dissolved solids
- in closed systems, where the coolant is not in contact with the outside air. This minimises corrosion and there is no build-up of dissolved solids. The cooling system may be refrigerated or pass through fan-cooled radiators.

Electricity is also consumed in cooling systems for pumping and for chilling in refrigerated systems.

2.12.1.4 Other energy requirements within the installation

Electricity is also used for ancillary equipment, see Section 1.4.3 Energy use in the heating, cooling and ventilation of work and storage spaces will depend on the installation construction, the location (such as northern or southern Europe) and the heat and water vapour losses as well as fumes from the process lines.

2.12.2 Water

Water supply and quality is critical in this industry. It can be used in cooling (see Section 2.12.1.3) but its other large use is in rinsing between process stages to prevent contamination of the next process, overreaction at, or staining of, the workpiece or substrate (see Section 2.4). The use of the water determines the quality required and the source(s) that can be used, and an installation may have more than one water source for different purposes. Water sources are:

- borehole
- river
- towns (mains) water
- recycling from other uses in the installation, such as rinses or treated effluents.

2.13 Abatement of potential releases to the environment

This section summarises abatement treatment options for potential releases. The main releases are described in Section 1.4.4. Potential environmental releases are identified as key environmental considerations for each activity described in the preceding sections of Chapter 2. These are:

- the emission of pollutants in waste waters
- the production of hazardous waste
- the emissions to air.

Emissions to air are the least significant of these. [104, UBA, 2003] Any release may require treatment to meet environmental regulations (IPPCD, art 9 and art 10 [1, EC, 1996]), including local requirements (environmental quality standards or legislation) [121, France, 2003].

2.13.1 Waste water

Installations for surface treatment by chemical and electrolytic activities are predominantly water-based and generate significant quantities of effluents containing both inorganic and organic pollutants. The wide range of processes and of raw materials means that effluents are complex and vary in composition by time, process and plant.

The most effective method for preventing pollutants entering the water environment is minimisation of the loss of materials. The water-based processes lose their materials by drag out into rinse-waters, and minimisation of these material losses in rinsing is discussed in the sections describing methods for rinsing and drag-out control, Sections 2.4, 4.6 and 4.7. Minimisation of water usage is also discussed in these sections.

The following issues form the basis for selecting the most appropriate means of waste water treatment and for setting emission limit values [111, ACEA, 2003] [3, CETS, 2002]:

- the type of processes which give rise to the waste water
- the volume and the composition of the waste water
- the fate or use of the waste water discharge (i.e. internal or external re-use, discharge to municipal waste water treatment, or direct discharge to surface waters) and the associated quality standards or requirements (environmental: receiving water and/or sewage sludge standards or production requirements) [111, ACEA, 2003]
- regulatory discharge requirements
- the composition of other streams discharging to the same watercourse or foul sewer (this may be for the consideration of the regulator)
- wider environmental impacts of adopting any particular process (for example, high energy consumption for little environmental gain).

Waste water treatment is described extensively elsewhere, such as generally in [87, EIPPCB,] and specifically for this sector [6, IHOBE, 1997, 13, UNEP, et al., 2002, 21, Agences de l'Eau de France, et al., 2002]. The following sections (Sections 2.13.1.2 to 2.13.1.15) are therefore a brief description of the usual contaminants and the activities used to treat them.

Waste water is contaminated by used reagents and the breakdown products from the processes. The main ingredients of concern are metal ions (cations), which are conservative, see Section 1.4.4.1 and toxic anions such as cyanide or chromate. Some of the waste water treatments themselves may produce contaminants that require further treatment, so any or all of the following categories of constituents may be present and are discussed in this section [21, Agences de l'Eau de France, et al., 2002] and see Section 1.4.4:

- organic materials (Section 2.13.1.2)
 - immiscible – non-halogenated oils, greases, solvents
 - immiscible – halogenated oils, degreasing solvents, paint solvents
 - soluble – wetting agents, brighteners, organic ions and ligands, e.g. acetate, EDTA (Section 2.13.1.8), organic materials expressed as COD
 - AOX – potentially formed in effluent treatment
- particulates suspended solids – metal hydroxides, carbonates, powders and dusts, film residues, metallic particles, etc. (Section 2.13.1.4)
- acids and alkalis (Section 2.13.1.3)
- metals – soluble anions from process activities (Sections 2.13.1.5, 2.13.1.6 and 2.13.1.7)
- nitrogenous materials – NH_4^+ , NO_3^- , NO_2^- (Section 2.13.1.9) from greasing, scouring, coating, phosphate coating, heat treatment, chemical nickel plating, etc.
- cyanides – CN^- , SCN^- from degreasing, coating, etc. (Section 2.13.1.10)
- fluorides – from scouring, passivation, polishing, coating, etc. (Section 2.13.1.12)
- phosphated compounds – from degreasing, phosphate coating, brightening, chemical nickel plating, etc. (Section 2.13.1.13)
- sulphides (Section 2.13.1.11)
- other salts – Cl^- , SO_4^{2-} , K^+ , Na^+ , Ca^+ . (Section 2.13.1.14).

All contaminants need either or both:

- chemical treatment to destroy or change them to less harmful chemical species, or more readily managed or removable chemical species
- separation from the water to predetermined levels. The removal of the contaminants from water can be by filtering and/or settlement techniques, followed by flocculation at the correct pH and settlement.

In some cases, the whole waste water treatment plant can operate with mixed waste streams. With some substances, it is preferable to segregate the waste water streams for individual treatment prior to separate discharge, or subsequent mixed treatment.

Treatment may be by batches or continuously for the whole or portions of the flow [3, CETS, 2002]. Batch treatment may be easier to control and supervise, but requires more capital plant capacity to contain the flow to be treated and may require more direct supervisory time. Continuous treatment requires more sophisticated control systems and their consequent maintenance.

Figure 2.42 describes the layout of a typical waste water treatment plant.

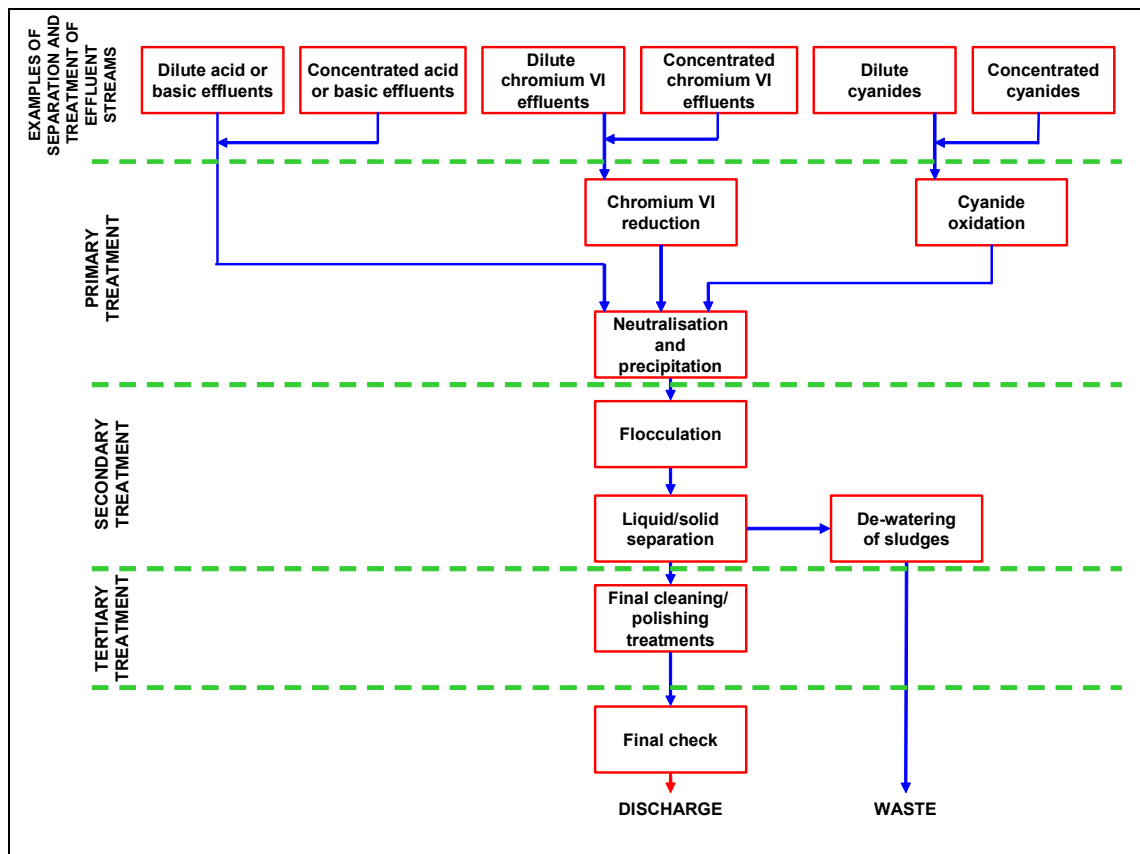

Figure 2.42: Flow diagram for a typical waste water treatment plant [21, Agences de l'Eau de France, et al., 2002]

Separation is normally by removing the contaminants from the water, but can also be by removing the water from the contaminants by:

- evaporation, with or without condensation of the water vapour, with a residual sludge
- by reverse osmosis, providing a purified, but not pure, water and with a waste water, which contains the concentrated impurities.

The residual concentrates may in turn be reduced to a solid by the addition of other materials or the evaporation of the remaining water [3, CETS, 2002].

2.13.1.1 Treatment techniques

Various treatment techniques are mentioned in the following sections. Some of them are also used for process solution maintenance, treatment of incoming water and for treating waste waters prior to recycling, see Section 2.7.

2.13.1.2 Organic materials

Immiscible organics

These are split into two groups:

- non-halogenated - oils, greases, solvents
- halogenated - oils, degreasing solvents, paint solvents.

These may first be reduced to their solubility limit by physical separation, such as flotation (such as for oils, electropainting solids) or for volatile substances, by liquid/liquid phase separation. For volatile organics, when levels below the solubility limit are required, two options exist [3, CETS, 2002]:

- air stripping, with removal from the air, e.g. by activated carbon, to circa 1 mg/l and final polishing by passing the waste water through activated carbon
- oxidation to carbon dioxide (and halogen acid in the case of halogenated organics) using UV irradiation and hydrogen peroxide addition.

Soluble organic materials

Wetting agents, brighteners, organic ions and ligands, e.g. acetate, EDTA, etc.

Sequestering agents increase the difficulty in removing metals by flocculation and settlement by complexing them and, if in surplus, may solubilise metals in the outside environment [22, Fraunhofer, 2002]. The concentration of miscible organics may be reduced by oxidation (such as by hypochlorite) by UV irradiation and hydrogen peroxide addition (typically 30 minutes), or their deleterious effects reduced by the addition of a benign metal salt, e.g. calcium chloride/hydroxide [3, CETS, 2002].

Reduction of COD

Dissolved organics in waste water raise the chemical oxygen demand (COD). The types of compounds present have highly variable breakdown rates, both chemically and biologically. Upstream prevention is usually the easiest option in reducing COD load.

Where COD requires treatment, biological treatment by arranging discharge to the municipal waste water treatment plant is usually the easiest treatment option. Note, however, some compounds in effluents can be resistant to biological oxidation, and it may be necessary to test the biodegradability of the effluent [121, France, 2003]. In some circumstances, chemical treatments may be necessary and they include [21, Agences de l'Eau de France, et al., 2002]:

- physico-chemical treatment
- chemical emulsion breaking
- adsorption on activated carbon or other similar materials
- membrane techniques
- concentration by evaporation
- oxidation techniques using hypochlorite, peroxide, etc.

AOX

Organic chlorine compounds can potentially be formed in effluent treatment when hypochlorite or chlorine are used as the oxidising agents.

2.13.1.3 Acids and alkalis

Acid and alkali discharges usually require pH adjustment to a range dependent on the receiving water or sewer before discharging. Continuous flow streams of opposite pH may be partially neutralised by mixing together. Batch discharges such as end-of-service life process solutions may be stored and mixed with solutions of opposite pH.

The chemistries of effluent pretreatments, such as reduction of hexavalent chromium or oxidation of cyanide, require a pH close to that of the originating process solution and are usually carried out prior to neutralisation.

Usually, pH control is on a continuous flow basis with automatic controls, although some discharges are treated on a batch basis.

2.13.1.4 Particulate material

Metal hydroxides, carbonates, powders and dusts, film residues, metallic particles, etc. may be removed by settling or filtration, see Section 2.13.2.1.

2.13.1.5 Metals – soluble anions

The concentration of metals re-use or for recycling, either directly or after further treatment, may be viable, depending on the chemistry of the solution and the technique used. Techniques are described in Section 2.7. The capture of precious metals, e.g. platinum, gold, silver, rhodium and ruthenium may be achieved from waste water by electrochemical recovery or by ion exchange (see Section 2.7.6 and 2.7.8 with the subsequent sale of the loaded resin or the concentrated regeneration liquor stream to specialist recyclers. The reclamation of other cations from waste water streams may be carried out individually or as a composite of several metals. Figure 2.43 shows an example of a treatment plant using ion exchange.

Where multiple processes are operated and where metal recycling is carried out, it may be preferable to concentrate or precipitate the metals arising from different metal plating lines in segregated streams. This may improve the economics and/or the practicalities of recovering the metals.



Figure 2.43: Example of waste water treatment plant using ion exchange (Productmetal S.A. and Agence de l'eau Seine-Normandie)

2.13.1.6 Reduction of oxidation state of metal ions

In some cases, it is necessary to reduce the oxidation state of the metal as the higher oxidation state(s) may not be readily flocculated and precipitated by pH change [3, CETS, 2002]. For instance, the reduction of Cr(VI) by sodium dithionite:

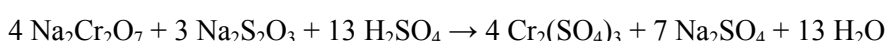

2.13.1.7 Precipitation of metallic floc

The multivalent metal ions are most conveniently removed by precipitation as the hydroxide and concentrations of individual metals in the post-settlement effluent well below 1 mg/l are achievable in theory. As the transition metals are amphoteric, there is a minimum solubility requiring careful pH selection and control (Figure 2.44):

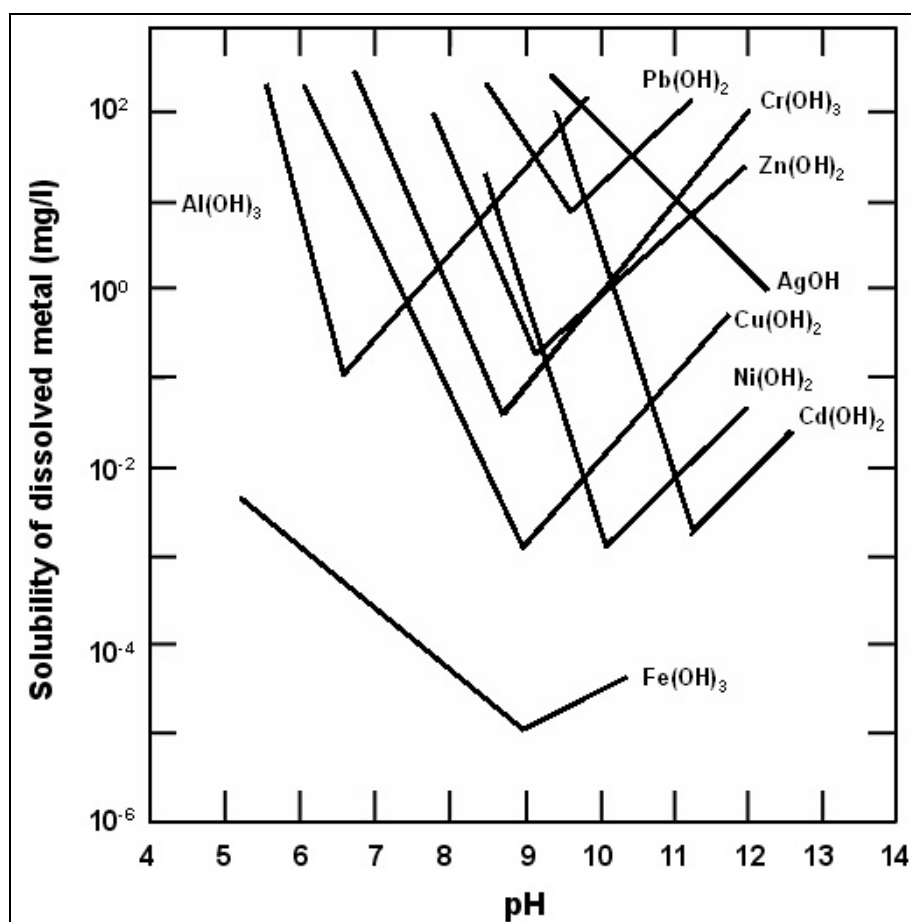

Figure 2.44: Variation of solubility of dissolved metal with pH

Simultaneous removals of several metal ions to very low levels may require selection of different pH values and settlement sequentially. The treatment of segregated streams may be preferable to sequential pH adjustments with intervening solids removal stages. The pH may require further adjustment prior to discharge.

The precipitated metals may be separated by settling. There are various types of separator or settlement tank such as [21, Agences de l'Eau de France, et al., 2002, 87, EIPPCB,]:

- longitudinal
- upward flow radial
- laminar.

The use of an anionic settling aid (a coagulant with high ionic charge density, such as ferric ions, aluminium chlorohydrate) or a polyelectrolyte may be beneficial in coagulating a stable floc and optimising settlement. They also assist with any subsequent sludge dewatering, see Section 2.13.2.1.

For low discharge levels (for example, below about 3 mg/l for zinc), the effluent will require polishing (tertiary treatment) by filtration using sand, mixed media, cartridge or pressure filters. For small discharges, direct filtration of the suspension instead of settlement may be more cost effective.

The settled floc or filtrate will contain about 5 % solids and is normally further concentrated by dewatering (see Section 2.13.2.1).

For residual metal ion concentrations below that achievable by hydroxide addition alone, insoluble sulphide based salts may be used in conjunction with post hydroxide addition. Dithiocarbamate (DDC) is one of a range of suitable materials which are capable of reducing the concentration of soluble transition metals to below 0.1 mg/l.

2.13.1.8 Complexing (sequestering, chelating) agents

Sequestering agents, particularly EDTA are being used in increasing quantities again in the printed circuit board industry to achieve the high specifications being demanded in modern printed circuit technology [22, Fraunhofer, 2002].

The success of precipitation processes is dependent on the reaction between the soluble metal ion and hydroxide. Complexed metals present problems as hydroxides are difficult to form and the presence of complexing agents can be a cause of failure in waste water treatment plants (i.e. breach of operating limits for metals in the effluent). Waste water streams containing the cyanide (which is a complexing agent) may be easily treated (see Section 2.13.1.10). Other sequestering agents present in a number of cleaners and proprietary electrolytes are more difficult to overcome. Where complexing agents are a problem, metal precipitation may be possible with the use of calcium hydroxide in place of sodium hydroxide or by the addition of calcium or magnesium chlorides which preferentially complex with the agent. Extensive prior digestion (>30 minutes) with strong oxidising agents has been found to be beneficial in reducing the effect of sequestering agents but will oxidise chromium and manganese which then require subsequent reduction prior to precipitation where these metals are present. Alternative organic removal treatments, e.g. activated carbon and non-ionic resins, prior to precipitation may be environmentally sound. Microbiological oxidation of organics remains a theoretical possibility.

2.13.1.9 Nitrogenous materials

Compounds containing nitrogen such as NH_4^+ , NO_3^- , NO_2^- come from degreasing, scouring, coating, phosphate coating, heat treatment, chemical nickel plating, etc. [21, Agences de l'Eau de France, et al., 2002].

Ammonia

If recovery by steam stripping is not economic, then ammonia may be oxidised to nitrogen and water with sodium hypochlorite. Any excess hypochlorite can be reduced using sodium sulphite. Ammonia can also be oxidised biologically, usually in a municipal waste water treatment plant.

Oxidation of nitrites

Nitrites can be oxidised with sodium hypochlorite at pH 6 with control of rH, usually automatically. It can also be oxidised with hydrogen peroxide to nitrate [113, Austria, 2003]. Nitrites can be reduced to N_2 with sodium bisulphite at pH 2; in this case, control by rH is not possible [121, France, 2003]. In an acid solution, nitrite can easily be reduced to nitrogen gas by using sulphamic acid [113, Austria, 2003].

Environmental considerations

AOX may be formed when using hypochlorite solution [113, Austria, 2003].

2.13.1.10 Cyanides

Cyanide (CN^- , SCN^-) from degreasing and coating may be oxidised. The cheapest and most widely used option is hypochlorite or chlorine gas used at high pH, which first oxidises the cyanide to sodium cyanate, and secondly to ammonium and carbonate after pH neutralisation (about pH 8.5). Any excess hypochlorite can be reduced using sodium sulphite. Sodium hypochlorite solution can be used, or chlorine gas can be used to generate hypochlorite ions *in situ* at larger facilities. Other oxidising agents such as hydrogen peroxide can be used, with pH varying according to oxidising agent [113, Austria, 2003] [159, TWG, 2004].

Environmental considerations

AOX may be formed when using hypochlorite solution or chlorine gas.

When using hypochlorite solution or chlorine gas, the pH for the first stage must be kept high to ensure a rapid rate of reaction and to prevent the formation and release of the volatile lachromate, cyanogen chloride.

2.13.1.11 Sulphide

Sulphide is normally controlled by the excess of the multivalent cations present in most waste water streams, with no further treatment necessary. Where it occurs in excess, it may be precipitated out as elemental sulphur on oxidation with hydrogen peroxide or iron III salts.

2.13.1.12 Fluorides

Fluoride occurs from scouring, passivation, polishing, coating etc, and is readily precipitated out as calcium fluoride at a pH above 7. The lowest solubility of calcium fluoride is 15 mg/l at pH 11.2.

2.13.1.13 Phosphated compounds

Phosphate compounds are used in degreasing processes, phosphate coating, heat treatment, brightening, chemical nickel plating, etc. Although they are not usually a problem, if necessary they may require control because of local environmental conditions: the release of several kilos of phosphorus per day can have an impact on a receiving river and its eutrophication [121, France, 2003], phosphate is most conveniently precipitated out as calcium hydroxide phosphate.

The solubility is less than 5 mg/l at a pH greater than 10.

2.13.1.14 Other salts

Other ions such as Cl^- , SO_4^{2-} , K^+ , Na^+ , and Ca^+ are not normally a problem, but local environmental conditions may require their removal.

Sulphate can be readily precipitated as calcium sulphate; the solubility product is 2 g/l depending on concentration of other ions.

Concentration of other ions may be desirable, and ion exchange, reverse osmosis or evaporation may be used either prior to one of the other treatments (above) or to produce a concentrate for disposal as a waste.

2.13.1.15 Final cleaning of effluent (polishing)

Whatever waste water treatment technologies are used, the treated water will contain small amounts of the treated components and a significantly higher concentration of more benign materials arising from the treatment reagents used. The effluent may be treated further and examples of this are [3, CETS, 2002]:

- fine (sand) filter (circa 5 μm) to remove residual particulate material
- activated carbon bed to remove organic material
- chelating, crown or thiol cation exchange resin bed to selectively remove multivalent ions.

2.13.2 Wastes

2.13.2.1 Sludge dewatering

Solids removed from the main effluent by precipitation or filtering may be further concentrated using a filter press, belt press or centrifuge to produce a cake manageable as a solid. Filter press treatment of metal hydroxide sludge at pressures above 15 bars can give a final cake with 15 - 35 % solids. The final solids of sludges from anodising rarely rise above 25 % [118, ESTAL, 2003, Sheasby, 2002 #132].

2.13.2.2 Sludge drying

Filter cake may be further dried to lower water content.

Environmental considerations

Drying requires 450 kWh of thermal energy per tonne. Waste heat from other processes can be used.

Drying may create a powdery waste at a water content of less than 40 %. This may cause more dust problems in handling than a solid cake.

Dried sludge containing residues of oxidising components, such as H_2O_2 , NaOCl or persulphates, are reported to heat up through exothermal reactions when stored in big bags, (tonne bags) and may eventually spontaneously combust [3, CETS, 2002].

In some cases, drying sludge may assist subsequent processing, such as solidification.

2.13.2.3 Liquid wastes

Some waste process solutions may be stored and disposed of as liquid waste, sent for specialist recycling or recovery or disposed of as hazardous wastes. Examples are autocatalytic plating solutions, spent etchants and sludges from anodising.

2.13.2.4 Other solid wastes

Surface treatment of metals and plastics generates other industrial wastes. These normally comprise the used packaging from raw materials (chemicals) and incoming workpieces or substrates, as well as discarded equipment such as broken jigs and barrels.

2.13.2.5 Sludge stabilisation

In some cases, such as where waste management regulations require, sludge may be stabilised [21, Agences de l'Eau de France, et al., 2002], although this is usually carried out off-site by specialist waste management contractors, [89, EIPPCB,]. For solidification, two main types of binder are used:

- hydraulic, such as cements, fly ashes from cement kilns or coal-fired power generation
- hydrocarbon-based, such as tars or bitumen (a process derived from the nuclear industry).

Drying of the sludge may be required prior to stabilisation.

Environmental considerations

The volume of waste solidified with hydraulic binders increases in volume 1.5 to 2 fold.

Waste treated with hydraulic binders (such as lime) may have a pozzolanic action and develop mechanical properties that increase stability with time. However, the surface active agents present may interfere with this reaction.

2.13.2.6 Valorisation of wastes

Techniques exist to externally re-use or recycle wastes. These include using sludges as a raw material in on-ferrous metals refining, and regenerating waste acids. These are described in Section 4.17.

2.13.3 Waste gases and other airborne emissions

There are two reasons for managing airborne emissions in surface treatment installations [111, ACEA, 2003]:

- where health and safety legislation applies to the workplace atmosphere for the protection of the employees from dangerous substances in the workplace
- working atmospheres that are damp, acid, alkali or which contain other chemicals and/or particulates are likely to be corrosive to materials, workpieces and substrates, equipment and the fabric of buildings. This can lead to problems such as deterioration of raw materials, finished products becoming corroded and being rejected, equipment malfunctioning and buildings deteriorating at a high rate. Many installations extract water vapour, as well as acid, alkali and other gaseous or aerosol contaminants to prevent these problems.

Additional treatment of the exhaust gases may be required to meet emission values,

2.13.3.1 Emission sources and types

Airborne emissions include gases, vapours, mists and particulates [111, ACEA, 2003]. The main sources are highlighted throughout Chapter 2 and include layer stripping (such as pickling and stripping baths), electrolytic degreasing baths, individual treatment processes, as well as some drag-out and rinsing processes (especially where the rinses are heated and/or sprayed). Particulates can be from mechanical processes such as finishing and polishing, or form from some mists containing chemicals where water vaporises from the droplets leaving airborne chemical particulates.

Harmful substances can be emitted to air as gases from relevant processes (e.g. NO_x , HF, HCl) as well as aerosols loaded with caustic, acids or other chemicals (e.g. caustic soda solution, sulphuric acid, chromium (VI) compounds, cyanide), see Table 1.4.

Emissions of solvents from solvent degreasing or drying of organic coatings (such as electropainting or lacquering) are discussed in [90, EIPPCB,].

2.13.3.2 Measures for reducing emissions

Measures can be taken to minimise pollutant emissions from sources. For example:

- air agitation of process solutions can be replaced with other methods such as:
 - circulating the process solution by pumping
 - mechanisms to move the jigs
- baths not in constant use can be kept covered
- additives can be used to suppress aerosol formation, such as for chromium plating. See Sections 1.4.4.1 and 2.5.3.

2.13.3.3 Extraction systems

Extraction systems can be installed for the capture of the emissions. Although some shops will have general extraction of the workspace, edge or lip extraction at the emitting vat is a widespread procedure. Lines may be fully enclosed with extraction systems. Transporter systems can include an integral lid which is put in place with the flight bar.

The quantity of exhaust air caught by the edge exhaust and the quantity of pollutants contained depend on several parameters:

- bath size
- continuous or intermittent operation of the bath
- bath temperature
- physico-chemical characteristics of the specific chemicals
- classification and permissible concentration values in the workplace
- use of additives for the decrease and/or avoidance of the emissions to HF, NO_x and Cr (VI)
- other emission control procedures
- fully enclosed treatment lines.

2.13.3.4 Waste gas treatments

The following cleaning systems are used:

- droplet separators which use a fill material to condense aerosols and droplets. Condensate is usually treated in a waste water treatment plant.
- exhaust air wet scrubbers. These may be:
 - fibrous packing scrubbers with mats of fibrous packing
 - moving bed scrubbers with a zone of mobile packing, usually low density plastic spheres which are free to move between support grids
 - packed bed scrubbers containing a fixed bed of variously shaped packing material
 - impingement plate scrubbers
 - spray towers.

Water or specific chemical solutions are sprayed into the wet scrubbers usually (but not always) countercurrent to the gas flow.

Reduction of NO_x could be achieved by selective reduction using $\text{NH}_2\text{-X}$ compounds (with $\text{X} = \text{H}, \text{CN}$ or CONH_2) injected into the gas stream. The most common reducing agent is ammonia. Both non-catalytic (SNCR) and catalytic (SCR) techniques exist.

These techniques and devices are described in more detail in the reference document on BAT in the waste water and waste gas treatment/management systems in the chemical sector [87, EIPPCB,]

2.13.4 Noise

The loading and unloading of loose components during delivery in stillages and loading for processing in barrels can give non-continuous peaks. Linishing and polishing generate continuous levels. Both may have associated in-house health effects.

For occupational health and safety it is often necessary to install air extractors combined with exhaust air scrubbers. The extractor motors and fans working at high rotational speeds can have deleterious effects outside the site buildings [121, France, 2003].

Other noise sources include refrigeration systems, heating systems, delivery vehicles, etc. [158, Portugal, 2004]

3 CURRENT CONSUMPTION AND EMISSION LEVELS FOR THE SURFACE TREATMENT OF METALS AND PLASTICS

3.1 Introduction – utilities and input materials

The most significant environment factors for surface treatment installations are energy and water consumption the efficient use of raw materials, the emission of pollutants in waters, and the production of hazardous wastes. The emission of pollutants into the air is of less consequence.

Many factors determine the consumption of raw materials as well as the emission of pollutants at these installations. There is some difficulty in producing comparable statistics for both consumptions and emissions because of the large variation between installations: it is likely that no two of the 18000 installations operated in the 15 EU Member States (EU-15) are similar enough in design and customers to be directly comparable with one another on a like-for-like throughput basis. The variations in the options for plant design are due to the large number of the operating parameters, see Section 1.2. and the general introduction to Chapter 2. The most important are: [104, UBA, 2003]

- the input substrates (e.g. steel, non-ferrous metals, plastics, etc.)
- the form of the workpieces (e.g. small components, wires, sheet metals, small and large coils, pipes, complex assemblies)
- the transport technology of the treatment (jig, barrel, continuous coil)
- the cleaning technology (aqueous, alkaline, acid, electrochemical, etc.)
- the technology for the manufacture of a metallic bright surface (pickling with hydrochloric acid, sulphuric acid, acid mixtures, etc.)
- the coating programme (e.g. copper, nickel, chromium, zinc, tin, alloys, combinations of individual layers such as plating followed by electropainting)
- the selection of individual coatings (chemical, electrolytic and process chemistry)
- the post treatment systems (chromating type, other systems)
- the rinsing technology
- the waste water and waste gas purification technology.

The best starting point for determining consumptions and emissions for comparisons would be on a throughput measure such as ‘unit used per square metre treated’. This would enable both interplant comparisons and individual plants to monitor their performance when considering and managing changes within the same plant. For surface treatments, the preferred basis would be surface area treated. However, the differing sizes, shapes and complexity of the workpieces and/or substrates make the accurate calculation of surface area difficult in all but the most straightforward cases.

On the emission side, the situation appears simpler, as emission standards and measurements exist. However, these are largely for end-of-pipe discharges. Relating discharge quantities to throughput factors for accurate comparison would be best, but are again very difficult.

However, none of these problems should prevent benchmarks being set. Consumption data such as energy usage can always be used in-house to monitor the individual installations’ ongoing performance [112, Assogalvanica, 2003]. Other benchmarks can be derived that may be used on an interplant basis. Material efficiency benchmarks are less complex to apply than surface-related ones and are closely related to the economic efficiency of the process, for example see Table 3.7 and examples in Annex 8.5. They can be derived by subtracting the amount of material emitted in wastes and waste water from the total amount of metal input [127, Oekopol, 2003, ÜBA, 2004 #123]. However, care must still be taken to ensure a like for like basis: there may be other sources of the material within the installation, for example dissolution of substrate such as zinc from zinc die castings in processing vats.

Some basic data are provided in this section. A set of studies on consumption and emission of metals for ten reference plants in Germany are included in Annex 8.5

Data on the key environmental considerations, such as substances of concern emitted, are given with process descriptions in Chapter 2.

Annex 8.3.1 provides examples of regulatory limits for various processes and countries.

3.2 Consumptions and emissions – utilities

3.2.1 Energy

Energy sources and uses are described in Section 2.12.1

Energy losses from the surface area of heated process solutions

Energy losses from the surface area of heated process solutions related to processing temperatures are shown in Figure 3.1, below. It demonstrates that the highest energy loss occurs from the solution surface with air extraction and with liquid agitation. Air extraction above the surface of process solutions enhances evaporation and thus the energy loss [3, CETS, 2002].

Processing temperature (°C)	<i>Without liquid agitation, without air extraction (W/m² tank surface area)</i>	<i>Without liquid agitation, with air extraction (W/m² tank surface area)</i>	<i>With liquid agitation, with air extraction (W/m² tank surface area)</i>
30	352	559	839
35	530	837	1209
40	757	1196	1677
45	1048	1635	2268
50	1426	2198	3012
55	1922	2910	3949
60	2587	3815	5129
65	3505	4973	6621
70	4824	6469	8521
75	6844	8436	10974
80	10279	11096	14212
85	17386	17386	21188
90	41412	41412	46023

Table 3.1: Energy losses at the surface of hot process solutions in watts/m²

3.2.2 Water

Water is used directly for rinsing purposes, or as make-up for recirculating water rinse systems. To a much lesser extent, it is required for making-up evaporation losses from process tanks and the washing of filtration and heat-exchange equipment. It may also be used in cooling systems. Note that unless water is recycled or re-used elsewhere, this consumption figure will be the discharge figure to waste water treatment.

The typical rinse-water usage for an example automated barrel zinc plating plant is [3, CETS, 2002]:

- output 6 barrels/h
- barrel length 1200 mm
- throughput c. 500 kg/h depending on the components
- plating electrolyte acid zinc, 33 g/l zinc
- plating stages 5
- zinc anode usage 20 – 25 tonnes/year
- plating time 45 min
- cascade rinsing
 - post first stage cleaning 4 stages (with return of drag-out)
 - post acid pickle 3 stages
 - post electrolytic degreasing 3 stages [125, Ireland, 2003]
 - post plating 5 stages
(with forced evaporation and drag-out return)
 - post passivate 2 stages
- overall rinse-water usage 600 - 1000 l/h.

Benchmarks for water usage are:

- a cleaned effluent discharge of 50 l/m² of treated surface area and with effluent containing less than 0.1 % of the metal used [8, Nordic-Council, 2002]
- an industry benchmark of about 40 l/m² (personal communication from Surface Engineering Association, UK)
- a maximum of 8 l/m² at each rinse stage [121, France, 2003] [58, France, 2003]. This equates to 40 l/m² with five rinse stages. is met by approximately 80 % of French surface treatment companies where the volume of treatment vats is greater than 10m³. Details of how this is calculated and rinse stage is defined are given in Section 4.1.3.1. PCB manufacture is a significant area where these figures may not be met (see Section 3.4.3.1).

3.2.3 Consumptions and emissions – materials

3.2.3.1 Pretreatment – degreasing

[104, UBA, 2003] The main emissions from aqueous degreasing processes are rinsing waters, separated oil and used degreasing solutions. Their generation, as well as consumption of degreasers, are determined by a number of factors which the operator can only partly influence. Three factors are important for the consumption of chemicals and the appropriate generation of waste water:

- degree of pollution of the workpieces
- service lifetime of the degreasing solution
- recycling of rinsing water concentrates into the degreasing tank.

Table 3.2 shows the large differences which are found in practice. All the enterprises here have similar coating programmes and are considered reference plants for good practice techniques.

Enterprise	Throughput of treated surface (m ² /yr)	Consumption of cleaning agent (t/yr)	Specific consumption (t/100000 m ²)
1	158000	1.24	0.78
2	200000	12.8	6.4
3	63000	0.13	0.2
4	468000	12.4	2.6
5	66000	7	9.0

Table 3.2: Specific consumption of degreasing chemicals

The substantial differences show that it is difficult to set up generally valid consumption figures for this production step.

Both separated oil and oil-saturated process solutions are produced. The quantity of the separated oil is identical to the quantity of oil which is introduced with the workpieces.

Rinsing waters and used degreasing baths are usually disposed of together through a waste water treatment system. It is assumed that all materials used in the cleaning solutions end up in the waste water.

3.2.3.2 Pickling

There are wide differences in the data for the specific consumption of acids in pickling, see Table 3.3. [104, UBA, 2003]

Enterprise	Throughput coated surface (m ² /yr)	Acid consumption (type and strength of acid not known) (t/yr)	Acid consumption t/100000 m ²
1	158000	24	15
2	200000	202	101
3	63000	21	33
4	468000	150	32
5	6000	1.3	2

Table 3.3: Specific consumption of pickling agent

In Denmark, a consumption of 5000 kg (96 %) H₂SO₄/100000 m² is usual. [73, BSTSA,] (5 t/100000 m², compared with Table 3.3).

The data in Table 3.4 show the metal dissolved from the substrate by the pickling action and discharged as a percentage divided by the quantity of metal treated.

Process	Emission ratio (%)
Copper pickling (copper and alloys)	0.013
Zinc pickling (zinc and alloys)	0.045
Stainless steel pickling (18 %Cr and 10 % Ni)	0.12
Copper printed circuit board etching	10
Stripping tin-lead	15
Aluminium etching	2

Table 3.4 Metal losses from pickling and related processes [51, France, 2003]

3.2.3.3 Rinsing

See Section 3.2.2, above, and Sections 4.7.9 and 4.7.10.

3.2.3.4 Core surface treatments

These include not only the metals used, but also process chemicals (e.g. inorganic acid, alkalis and salts) and proprietary additives (e.g. brighteners, anode metals and effluent treatment chemicals). The loss of materials is mainly due to drag-out, but cleaning and maintenance (especially of filtration equipment) leakage and spillage are small but significant contributors.

Coating (deposition) processes

The French water agencies have determined the emissions of pollutants for the principal uses in surface treatment. These values are estimated without taking into account any techniques for reducing or recycling pollution. Some of these may be over-estimated, especially for the printed circuit board industry [51, France, 2003].

The data indicate the metal discharged as a percentage of metals used in the process (anodes, salts, etc.).

Process	Emission ratio (%)
Nickel (electrolytic)	19
Nickel (autocatalytic/chemical)	45
Nickel (phosphating)	55
Copper (electrolytic)	9
Copper (autocatalytic/chemical)	16
Zinc hot dip coating (not covered in this BREF)	6
Zinc (phosphating)	32
Cadmium (plating)	8
Chromium (hard)	40
Chromium (decorative)	52

Table 3.5: Metal losses from coating processes [51, France, 2003]

There are similar differences for the specific electrolyte consumption with zinc electroplating. [104, UBA, 2003] (It is important to specify the type of zinc bath. [73, BSTSA,])

Enterprise	Throughput coated surface (m ² /yr)	Electrolyte consumption (t/yr)	Specific electrolyte consumption (t/100000 m ²)
1	158000	38	24
2	200000	160	80
3	63000	6	9.5
4	468000	90	19.2
5	66000	15.3	23

Table 3.6: Specific consumption of electrolyte

In Denmark, metal consumption for a hot acid zinc-bath is estimated to be 1500 kg Zn/100000 m², if drag-out recovery is used (1.5t Zn/100000m²).

Installation	Metal	Metal input	Metal in waste	Metal in waste water	Metal efficiency
I	Zn kg/yr	4520	770	15	82.63
	Zn %	100	17.04	0.33	
II	Zn kg/yr	10000	1830	0.75	81.69
	Zn %	100	18.30	0.01	
III	Zn kg/yr	12500	2630	3.9	78.93
	Zn %	100	21.04	0.03	
IV	Zn kg/yr	25200	4620	32	81.54
	Zn %	100	18.33	0.13	

Table 3.7 Efficiency benchmarks for different zinc plating installations
Oekopol: extract of installation database 2003 [127, Oekopol, 2003]

Autocatalytic nickel

There are many autocatalytic nickel processes with varying amounts of phosphorus, each with a different life in terms of MTOs. The amount of nickel per litre is about 6g. With 8 MTOs and plate out, up to 5 g/l results in a nickel use of 49g and residue of 5 g in the spent solution. The nickel waste can be reduced by membrane electrolysis and the rest of the spent solution can be reduced to about 3 g/l using steel cathodes. Current processes are being trialled with MTOs of 15 – 20. An MTO of 4 is not unusual and has a much lower efficiency. This makes calculating a universal % efficiency very difficult (personal communication, CETS VOM).

Hexavalent chromium plating

Annex 8.6 gives details of a typical small decorative chromium line, with eco-rinse (see Section 4.7.4) and two counter-flow cascade rinses (which do not return to the eco-rinse). The material efficiency has been measured as 52 %. Without eco-rinse, this would fall to 20 – 30 % (Collini, GmbH).

Phosphating

Table 3.8 shows the efficiency of metal uptake in the applied phosphate layer and losses from a typical modern tri-metal system for corrosion prevention, such as that used in the automotive industry. Nickel efficiency may be in the range of 8 – 16 %.

	Zn %	Ni %	Mn %
Process conditions			
Process pH	1.3 to 1.7		
Metal phosphate solubility	95	98	96
Distribution of metals in a typical phosphating system			
Efficiency of metal uptake in phosphate corrosion layer	40	8	21
Metal in waste water	7	55	25
Metal in phosphate sludge	53	37	54

Table 3.8 Phosphating efficiencies and losses in the automotive industry
[163, Gock and Schlmroszyk, 2004]

Sludge production is inevitable with steel substrates at this pH, with an industry view that the more Fe dissolved the better the coating. Phosphating on zinc gives hardly any sludge, and on aluminium gives large amounts of cryolyte (a Na_3AlF_6).

Modern standard paint lines (over the last 10 – 15 years) will make use of countercurrent rinsing usually with 2 or 3 stages. This technique has been responsible for massive water savings in many companies. The rinses could be fed back, but generally there is too much liquid when the make up chemicals are included.

There have been attempts to concentrate the rinsing waters using membrane techniques such as reverse osmosis or electrodialysis. However, these give rise to pH control problems and precipitation of phosphates, although H_3PO_4 can be added. Electrodialysis has been trialled on large lines, but has failed as process control of the solution is quickly lost, due to the complicated solution kinetics. [164, Wittel, 2004]

Conclusions

Industry data in Table 3.9 demonstrate low material efficiencies except where financial factors (such as for gold, silver) or environmental regulatory pressures (such as for cadmium) are paramount. [3, CETS, 2002]. In these cases, higher efficiencies can be achieved by reducing reworking and using techniques for drag-out and materials recovery, and many of these techniques can be used with other processes (in general, see Sections 4.1.2, 4.6, 4.7, and 4.12). Material efficiency data for modern zinc plating installations vary mainly with the form of the workpieces and the transport technology used.

Process	Efficiency % [29, EA, 2001-3]	Efficiency % [3, CETS, 2002]	Comments on data
Zinc plating (all processes)	90 95 for coil coating [119, Eurofer, 2003]	70 – 80	70 % is likely with passivation (when Zn is redissolved by the acid chromating), 80 % without passivation
Nickel plating (closed loop)	95	(without recycle) 80 – 85 (with recycle) 95	
Autocatalytic nickel plating	95 (excluding losses in spent solutions)	95(excluding spent baths)	This varies widely according to process type, specification to be met and MTOs and is very difficult to define (see Section 2.5.8 and comments in this section)
Copper plating (cyanide process)	95	80	
Tin and tin alloys	95	95	
Chromium plating (closed loop)	95	96 15 (without recycle)	Low efficiency (25 – 30 %) without recovery confirmed (Annex 8.6)
Precious metal plating	98	98	
Cadmium	99	99	
Phosphating	90		Zn 40 %, Ni 8 -.16 %, Mn 21 % are typical values achieved and there is a lack of data describing techniques accounting for the wide range between column 2 and Table 3.8
Anodising	90		
Electroplating pigment, (i.e. electropainting)		98	

Table 3.9: Process efficiencies with respect to input materials

3.3 Overall emissions

3.3.1 Waste water

Overall

Information about waste water discharges from several sources has been reviewed.

Source	Data type	Sample type
ACEA	Phosphating discharges from three automotive production installations	According to local regulation, i.e. German or UK.
CETS Netherlands	One installation: review of data over six years	Daily composites
Finland	Two installations treating for phosphate	
France	Review of unannounced sampling over the period 2002 – 2003 for more than ten surface treatment installations representing the range of activities in the BREF.	Daily composites
Germany	419 samples taken	According to the German sampling regulations
Netherlands	One installation	Spot samples for a year
Nordic Council	Summary data from a BAT assessment study	
Sweden	Analytical and annual emission reports for nine installations, both contract and in-house	Daily and monthly flow-proportional composites
UK	Review of 30 IPPC applications	Mainly spot samples

Table 3.10: Data sources and types for waste water discharges

The individual sources are discussed in more detail, below. The data are summarised at the end of this subsection, and in Table 3.20. This includes the derivation of emission ranges associated with potential BAT.

The data focuses on the emission values of substances, and the ranges found. There are number of examples of high outliers. However, it is also important when considering an installation to look at the overall load discharged per day (or per other period, such as year). In some cases, it has been possible to identify that unusually high emission values are associated with relatively low loads. Also, it can be seen that loads may not vary significantly, even where there are high outliers to the associated emission values.

As can be seen from the sources (above) there is a large variation in the source and type of data and the sampling and analysis used. The analysis of the data (below) shows:

- some data provided has already been summarised, some not. It is not possible to draw overall conclusions about the reliability, repeatability and accuracy of data, as well as confidence intervals
- little information on likely errors in the data provided
- each installation has differences which are not fully given (including potential BAT used) for:
 - size and throughput
 - production lines layout
 - rinsing and other in-process control techniques
 - chemicals
 - waste water treatment
- no data is given for the:
 - age of installation or significant processes
 - percentage of full capacity of each production process
 - capacities and relative contributions where there is more than one production process,
 - geographic location and local environmental conditions (except see below: ACEA information on discharge to public sewer, and Swedish discharges containing phosphate and aluminium to public sewer).

ACEA

ACEA submitted data from three phosphating plants (prior to painting), shown in Table 3.11. The samples are taken according to local regulations (Germany and the UK). The discharges from the surface treatment activities on these large plants are combined with effluents from other sources: the contributors have taken account of the dilution given. ACEA comment that discharges from these plants are to public sewer (PS) and these values take into account local environmental conditions, including treatment in municipal waste water treatment plants. They also comment that suspended solids is relevant for effluent discharges, not settleable solids. Settleable solids is used internally for the operator's process control.

Nickel	PS mg/l 0.99	Type of sample (e.g. spot or 2 hour or daily composite), dilution by and types of non-PO₄ effluents included in sample Batch WWT process so batch samples. Dilution minimal, about 5 % is non-STM effluent.
COD	600 - 1400 (plant 1) or 2000 (plant 4)	Composite samples, sampled after the waste water treatment plants, so diluted by non-STM processes, give range 600 - 1400mg/l (plant 1). Spot samples from 2002 (for plant 3) as high as 1100mg/l. Plant 4 WWT batches sampled, giving 2000mg/l.
HC total	Estimate composite: 2.7 - 20, average 8 (plant 3) 22.5 (plant 4)	Data is oil/grease expressed as non-volatile matter extracted by 40/60 petroleum spirit. Spot samples average 24mg/l (range 8 - 61) Similarly, oil and grease data for plant 4 = 22.5mg/l (Determined by acidification and extraction with tetrachloroethylene. The samples are passed through columns containing florisil and magnesium sulphate and the resulting extracts are quantified by Fourier Transform Spectroscopy.)
VOX	0.3	Annual mean values based on random sampling. Sampling at point of discharge to river, so concentration is reduced due to dilution from other sources. We/the authorities calculate with a dilution factor of 10, which has already been applied to give 0.3mg/l (plant 5).
Settleable solids	30 - 100	Composite samples after the waste water treatment plants, so diluted by non-STM processes (1).

Table 3.11: ACEA emission values for phosphating plants

CETS Netherlands

CETS Netherlands (VOM) provided data ranges for a large contract plating shop, with both electro- and electroless plating. The samples reviewed were flow-proportional daily samples. The range of emission values are given in Table 3.11. Data was also supplied on total metals loads and total volumes for several years. Flow has been approximately halved, with the introduction of more cascade rinsing and changing one nickel barrel plating line to electroless nickel. However, loads have stayed broadly the same (apart from the effect of the overall economic situation of the industry). This is attributed to the difficulty in older process lines of finding space to increase the number of cascade rinsing stages. Also, it was commented that it is not possible to achieve the lowest levels for all metals simultaneously, or for any metal 100 % of the time. This may be due to different loading on different lines, some process chemical interference or the physico-chemical characteristics of the waste water treatment plant (for example, see differing metal solubilities, Figure 2.44). See also German data, below.

	Annual flow m³	Annual metal load k/yr*	Mean daily load kg/day	Comments
1979 to 1997	9032	20	0.084	
1998	9244	12.5	0.053	
2000	10233	26	0.109	Changes in rinses and processes implemented
2002	5607	14.5	0.052	Abnormally low throughput due to sector economic situation
2003	5881	10.5	0.042	
*Metals are: Total Cr, Cu, Ni, Zn, Sn, Pb. 238 working days a year				

Table 3.12: CETS Netherlands (VOM) Flow and load data for a contract plater

Finland

Ranges for phosphate emissions were given for two Finnish reference plants based on average daily composite samples for installations using potential BAT to treat phosphate (see Section 4.16.8.2)

	Reference plant 1	Reference plant 2
Process	First stage: Separate precipitation with Ca(OH) ₂ for waste waters coming from phosphating (10 m ³ /h). Second stage: Treat the residues from first stage together with other waste waters (5 m ³ /h) from a surface treatment installation. This includes hydroxide precipitation and sand filtration and after both treatments waste waters are discharged into public sewer	Waste waters coming from an anodising plant are treated by precipitation
Discharge to:	Combined flows discharged to public sewer (PS)	Discharged into surface water (SW)
Ranges	0.4 – 2.5 mg/l as total phosphorus	0.03 – 0.41 mg/l as total phosphorus
Proposed range		0.5 - 4.0 mg/l as total phosphorus

Table 3.13: Finnish phosphate emission values

France

In France, for many years national policy has been to discharge waste water from surface treatment installations to surface water after complete treatment on site. Discharge to municipal waste water treatment plant is only considered after a detailed analysis including biodegradation studies, and must achieve an additional reduction in pollution [121, France, 2003].

France reviewed daily composite samples from unannounced (unexpected) sampling during the years 2002 to 2003. These were for more than ten surface treatment installations chosen to represent the range of activities in this BREF. The summarised data is shown in Table 3.20.

Germany

Currently, in Germany approximately 94 % of the surface treatment industry discharges its waste water into local sewerage systems. [104, UBA, 2003] Pretreatment is required in the installation prior discharging. In the case of physico-chemical pretreatment the toxic anions (such as cyanide) in the sewage are destroyed and heavy metals are removed to the required standard. Further treatment is given in the local biological municipal water treatment plant.

By using state of the art water-saving rinsing techniques and by multi-stage waste water treatment plants, both the waste water amount and the pollutant concentration in the cleaned waste water can be minimised. The load of pollutants from surface treatment into the waters is small, as Table 3.14 and the reference plants in Annex 8.5 show:

Enterprise	Coated surface m ² /y	Zinc load kg/y	Chromium load kg/y	Specific zinc load kg/100000 m ²	Specific chromium load kg/100000 m ²
I	63000	3036	0.910	4600	1370
II	158000	3900	1120	2470	0.709

Table 3.14: Heavy metal loads from electroplating installations to municipal sewerage systems [104, UBA, 2003]

Germany has provided data on nine reference plants (see Annex 8.5). Table 3.15 shows the percentage of input metal that is discharged from each reference plant after waste water treatment (the data sets are not complete for all plants).

Reference Plant	Chromium %	Copper %	Nickel %	Zinc %	Overall metals discharged as % of input
A		0.05	0.05		0.05
C	0.032	0.14	0.008		0.02
D	Insufficient data				
E				0.007	0.007
F	0.05 (estimated)			0.008	0.01
G				0.037	0.037
H				0.015	0.015
K	Zero discharge				
L				0.002	0.002
Ranges	0.32 - 0.48	0.05 - 0.14	0.008 - 0.05	0.002 - 0.037	0.002 - 0.037

Table 3.15: German reference plants in Annex 8.5: percentage of input metals discharged in waste water

These data broadly show metals outputs to waste water as a percentage of metal inputs of 0.002 to 0.037 %. These levels are significantly lower than the Norwegian value (see below). Exact details are not known, but the waste water treatment plants may be optimised for one of the metals, such as zinc or nickel, as in two cases where more than one metal is used, the least used metal is the least efficiently recovered or removed (see also CETS Netherlands).

Germany also supplied 429 details of samples taken of waste water discharges. The samples were taken according to the German sampling regulations. These data are summarised in Table 3.16.

	Cr total mg/l	Cu mg/l	Ni mg/l	Zn mg/l	CN free mg/l
Number of samples reported for the metal	398	419	399	419	116
Maximum mg/l	0.5	0.6	0.7	1.9	0.11
Minimum mg/l	<0.1	<0.1	<0.1	<0.5	<0.05
Median mg/l	0.125	0.2	0.2	0.8	0.04
Average mg/l	0.181	0.207	0.215	0.972	0.046
Standard deviation (SD)	0.109	0.123	0.116	0.368	0.024
95 % confidence interval (1.96SD)	0.214	0.241	0.227	0.721	0.047
Max value for 95 % confidence	0.395	0.448	0.442	1.693	0.093
99 % confidence interval (3.29SD)	0.359	0.405	0.382	1.211	0.079
Max value for 99 % confidence	0.54	0.612	0.597	2.183	0.125
Note: calculated using Excel and assuming average equates to mean value.					

Table 3.16: Summary data from German surface treatment waste water samples
UBA

From these data it can be seen that the average and median values are generally well below the mid-point given by averaging the two extremes of the ranges: the exception is zinc. This suggests that there is a skewed distribution. It is important to note that the actual average discharge as an instantaneous value or load lies well below the theoretical mid-point between the range values in most cases. The 95 % and 99 % confidence values show the value to be set to cover respectively 95 % and 99 % of values in the range. For example, for zinc, a value of 2.183 mg/l covers the full expected range of values with 99 % confidence, while for chromium it is 0.54 mg/l.

The Netherlands

The data set summarised in Table 3.17 is for 312 spot samples from one factory for 2003. The company specialise in hard anodising, chemical nickel, silver plating, tin plating as well as other finishes. The average values are very low, and the median values frequently zero. The standard deviations are significantly larger than the averages. Interestingly, the range maximum for nickel and the 99 % confidence level are the same as the limit value. The maximum and 99 % confidence value for aluminium are also close to the limit value. The values for chromium are less close, but for this data set, the data show that for an average of 0.127 mg/l (which is again low) and 99 % compliance can be achieved at 1.059 mg/l.

	Al	Pb	Zn	Cu	Cr	Ni	Daily volume
Limit value Units	20 mg/l	mg/l	0.7 mg/l	1.5 mg/l	1.5 mg/l	1.5 mg/l	15 m³
Samples per determinand (maximum 312)	303	302	302	302	302	303	312
Max	19.500	0.070	0.358	0.245	1.500	1.500	81
Min	0.000	0.000	0.000	0.000	0.000	0.000	0.0
Median	1.958	0.000	0.000	0.000	0.020	0.174	26.5
Average	3.165	0.003	0.004	0.011	0.127	0.323	26
Standard Deviation	3.553	0.011	0.026	0.035	0.238	0.386	19.64
95 % confidence level	10.264	0.022	0.025	0.067	0.585	1.274	55.45
99 % confidence level	19.122	0.067	0.069	0.181	1.059	1.500	72

Table 3.17: Summary data for waste water samples for a Netherlands factory

Note: calculated using Excel and assuming average equals mean value.

Nordic Council

In the Nordic countries, an investigation of installations using good practice derived a benchmark figure of a treated effluent discharge of 50 l/m² of treated surface area with an effluent containing less than 0.1 % of the metal used [8, Nordic-Council, 2002].

Sweden

The policy in Sweden is similar to France: surface treatment installations treat their effluent for discharge to surface water. The exceptions are effluents high in aluminium and phosphate, which are usually required to discharge to municipal waste water treatment plant. Regulatory control is based on load per year, with guidance values for emission limit values. These are based on daily and monthly flow - proportional composites.

Raw data were supplied for nine installations. They are a range of contract and in-house installations, and of typical sizes for the sector: usually two or three production lines and 25 to 100 m³ per day discharges. The samples were for daily or monthly averages, according to the priority for control: daily samples for substances such as cyanide, where impact is instantaneous and monthly where load was more critical. The data is summarised in Table 3.18. When examining the data, where the maxima data were found, it was possible to calculate the daily load based on average flows (individual daily flows were not available). For aluminium, the next highest value has also been given to show the outlying nature of the highest values. These all imply the daily load to be relatively small, and that the occasional high value does not have a great impact on the annual load figure (or average daily load). This suggests that the mean (averages) and the median for these data would also be well below the value mid-way between the range maximum and the range minimum, as for the data from Germany and Netherlands.

The ranges for daily and monthly samples are usually similar and have been combined to form one range in most cases. The ranges for surface water discharges and public sewer discharges to waste water treatment plant have also been combined where there is little practical difference: they have been kept separate where there is a significant difference and for aluminium, where there are reasons to consider the ranges separately.

Determinand (and Swedish advisory limit values)	Surface Water (SW)		Public Sewer		Combined range	Load kg per day associated with highest emission value
	Daily composite sample	Monthly composite sample	Daily composite sample	Monthly composite sample		
Ag mg/l (0.1)	0.013 - 0.019	-	-	-	0.013 - 0.019	-
Al mg/l	-	<0.2 - 75	17 - 120	<0.002 - 230	SW <0.2 - 75 (next highest 0.67) PS <0.002 - 230	SW 0.291 (next highest 0.001) PS 0.341
CN free mg/l (0.1)	<0.01 - 0.17	-	-	-	<0.01 - 0.17	
CN total mg/l (1.0)	<0.01 - 0.26	-	-	-	<0.01 - 0.26	
Cr VI mg/l (0.1)	<0.01 - 0.18	-	<0.02 - 0.11	<0.02 - 0.02	<0.1 - 0.18	0.0005
Cr total mg/l (0.05)	-	<0.01 - 1.5	-	<0.01 - 0.28	<0.01 - 1.5	0.008
Cu mg/l (0.05)	-	<0.01 - 0.8	-	-	<0.01 - 0.8	0.063
Fe mg/l	-	0.06 - 1.2	0.08 - 1.5	-	0.06 - 1.5	0.071
Ni mg/l (0.05)	-	<0.03 - 2.1	-	<0.04 - 0.31	<0.03 - 2.1	0.046
Phosphate as PO ₄ mg/l	0.11 - 2.6	1.1 - 20	-	0.02 - 5.1	0.11 - 20	0.017
Pb mg/l (0.05)	-	<0.05 - <0.1	-	-	<0.05 - <0.1	
Sn mg/l (1.0)	-	0.2 - 30	-	-	0.2 - 30 (next highest 2.4)	0.002
Zn mg/l (0.05 - 2.0)	-	0.01 - 1.3	-	<0.01 - 0.62	0.01 - 1.3	0.025
COD mg/l	110 - 240	-	-	-	110 - 240	
Total extractable aliphatic material mg/l	<1 - 15	-	-	-	<1 - 15 <1 - 32	
Total extractable aromatic material mg/l	<1 - 32	-	-	-	Range for total extractable organic material <1 - 32	
Suspended solids mg/l (10 for SW)	<5 - 17	<5 - 25	<5 - 710	5 - 10	SW <5 - 25 PS <5 - 710	

Table 3.18: Summary of Swedish waste water data from nine installations

The United Kingdom

Data were compiled from 37 IPPC permit applications. Of these sites: 4 only released aluminium to public sewer, one discharged to surface water at very low levels, two were so small that the effluent was tankered away. The remaining 30 sites all discharged to public sewer after effluent treatment. Regulation in the UK is usually with instantaneous emission limit values, although load per day is taken into consideration. The data is based on a mixture of spot samples, averages of spot samples over a period of time, and some composite samples. The data are summarised in Table 3.19. It is not known if the peak values are for spot samples, but a range derived from spot samples are likely to show higher values than composite samples (see data from Germany). The new benchmark value is included.

Metal	Number of sites discharging metal in sample of 30 sites	Minimum mg/l	Maximum mg/l	normal range mg/l	IPPC benchmark value (Oct 04)
Chromium (total)	17	0.1	5	1 to 3	1
Copper	6	0.25	3	0.25 to 1	1
Lead	7	<0.01	0.2	0.05 to 0.15	1
Nickel	10	0.1	5	0.2 to 1	1
Silver	1	0.1	-	-	0.1
Tin	1	2	-	-	2
Zinc	16	0.01	8	0.2 to 6	2

Table 3.19: UK data for emission values to waste water from 30 IPPC permit applications

3.3.1.1 Conclusions for waste water emissions

Overall comments

The ranges of emissions discussed above are summarised in Table 3.20. Benchmark (reference) emission values have been derived from this data, as representing the current performance of the installations discussed above, using a selection of techniques such as those described in Chapter 4 describes for:

- minimisation of water and material discharged from the processes (see Sections 4.5, 4.6, 4.7)
- treating waste water (see Section 4.16).

However, it should be noted that it can become difficult to maintain stable pH values in the narrow margins required to minimise the solubility of individual metals when dealing with a mixture. The reduction in the volumes of water can also increase the concentration of dissolved salts and the various metals. Both these factors can increase the solubility of metals in the waste water treatment. This demonstrates that when applying a number of potential BAT in the process and the end-of-pipe treatment, it is not possible to optimise for every parameter, i.e. to minimise all metals discharged, maximise their retention in-process and reducing water consumption (see Section 4.16).

The amount of metals discharged as a percentage of the input metals varies between 0.002 and 0.1 %. The limited data indicates that this will be dependent on the in-process and waste water treatment techniques, as well as the combination of process techniques and metals used. The retention and/or removal efficiency is independent of the proportion of the metal used where there is more than one process, showing that it may not be possible to optimise the system to reduce all components discharged equally (see cadmium and mercury, below).

Examples of applying a mixture of both minimisation and treatment techniques is described in the reference plants in Annex 8.5 [123, UBA, 2004], and in reports on sites visited [Tempany, 2002 #18].

The emission values associated with potential BAT derived here reflect the current performance of some installations in the sector (where data has been provided). However, they are not limit values (see the Preface and introduction to Chapter 5). Some limit values are included in the discussion above for reference. Some typical emission limits for some European countries are given in Table 8.2 and Table 8.3, Annex 8.3. Values are also given for PARCOM 92/4 and HELCOM 23/7 recommendations, and for metals limits in the Drinking Water Directive 98/83/EC. The benchmark ranges in Table 3.20 largely fall within the limit values.

The emission values associated with potential BAT are expected for samples that are daily composites:

- taken after treatment and before any kind of dilution before discharge
- unfiltered prior to analysis.

When considering the values, weighting has been given to daily composite samples and outliers have been discarded. As discussed in individual data sets, what cannot be seen in range values is that, in many cases, the average values used for load calculations will be towards the low end of the range.

Cadmium and mercury

Both are controlled by other legislation. Cadmium is used in the sector, but in a limited number of installations and under tight controls. It is also present as a contaminant, particularly in all zinc anodes (see Section 2.5.4). Low levels can sometimes be detected and this supports the argument that metals are not retained or removed in proportion to their usage in the plant. Mercury is not used in this sector's processes, but may be present due to contamination in caustic soda produced by mercury cell chlor-alkali processes.

Other metals

Silver has been assumed to be towards the low end of the limited data range available, for cost reasons (see Section 4.11). Concentrations of aluminium are only important to surface water discharges (see 4.17.3), so a range has been derived on this basis. For chromium, copper, nickel and zinc the data shows that the installations considered operate within these ranges (excluding some outlying results), although for individual sites, the average data may be towards the bottom of the range. The iron range is only applicable to surface water discharges.

Fluoride

A range for surface waters has been derived from French data.

COD

A range for surface waters has been derived from French data.

Phosphates

The range here is derived for only for effluents discharging to surface water (see Section 4.18.8.2).

Hydrocarbons

For these substances, definitions and analytical methods vary between sources. A range for surface waters is derived from French data.

VOX

There is data for surface waters from France and public sewer from ACEA.

Solids

Some Member States use suspended solids (such as Sweden) and others use settleable solids (such as France). There is no data for any relationship between these values. The range has been derived for surface waters data from France and Sweden: both these ranges are close, but the top of the range has been raised slightly to account for any differences.

All values are mg/l	France	Finland	UK	Germany	Sweden	NL	CETS VOM	ACEA	Emission levels associated with potential BAT	
Note: PS = Public sewer SW =surface water	>10 plants	2 plants	Normal range 30 plants	1 plant	9 plants	1 plant	1 plant	Discharges to PS 3 plants	PS or SW	Additional determinands applicable to surface waters (SW) only
Ag	0.1 – 0.5				0.01 - 0.02		LoD - 2.0		0.1 – 0.5	
Al	1 – 5.0				<0.02 - 6.7 (SW) <0.02 - 230 (FS)	<0.1 - 19.5				1 – 10
Cd	0.1 – 0.2								0.1 – 0.2	
CN free	0.1 – 0.2			<0.02 - <0.28	<0.01 - 0.17				0.01 – 0.2	
Cr(VI)	0.1 – 0.2				<0.01 - 0.18				0.1 – 0.2	
Cr total	0.5 – 2.0		1 – 3	<0.1 - 0.5	<0.01 - 1.5	<0.1 - 1.5	0.02 - 0.1		0.1 – 2.0	
Cu	0.5 – 2		0.25 – 3.0	<0.1 - 0.5	<0.01 - 0.8	<0.1 - 1.5	LoD - 2.8		0.2 – 2.0	
F	10 – 20									10 – 20
Fe	1 – 5				0.06 - 1.2 (SW) 0.06 - 1.2 (FS)					0.1 to 5
Hg	<0.05								0.01 – 0.05	
Ni	0.5 – 2		0.2 – 1.0	<0.1 - 0.3	<0.03 - 2.1	<0.1 - 1.5	0.02 - 2.7	0.99	0.2 – 2.0	
Phosphate as P	5 – 10	0.03 – 2.5			0.11 - 0.62					0.5 – 10
Pb	0.2 – 1		0.05 – 0.15		<0.05 - <0.1		All <LoD		0.05 – 0.5	
Sn	1 – 2				0.2 - 2.4		0.3 - 2		0.2 – 2	
Zn	0.5 – 2.0		0.2 – 6.0	<0.5 - 1.5	0.01 - 1.3	<0.1 - 0.4	0.5 - 1.4		0.2 – 2.0	
COD	150 – 500				110 - 240			600 - 2000		100 – 500
HC Total	1 – 5 (PS or SW)							2.7 - 20 (average 8)		1 – 5
VOX	0.1 – 0.5							0.3		0.1 – 0.5
Solids	5 – 20				<5 - 25 (SW) <5 - 710 (FS)			30 - 100		5 – 30 (for discharges to surface waters)

Table 3.20: Summary data for emission ranges to water including values associated with potential BAT

3.3.2 Waste

There are several types of waste (see Section 1.4.4.10). An overview of the consumption of materials to processes and emissions, particularly to waste and waste water are given in Section 3.1. For most surface treatment shops the most significant waste is the solids (sludge) produced in the waste water treatment plant, and the amount produced is directly linked to the material consumptions and process efficiencies, and more details of these are given in 3.2.3.

The sludge or filter cake is usually concentrated by batch pressure filter and contains 60 – 80 % water, depending upon the maximum filtration pressure and sludge composition [104, UBA, 2003]. Aluminium hydroxide sludges from anodising generally do not go below 75 % water content [118, ESTAL, 2003]. The addition of flocculating agents can aid water extraction (see Section 4.16.7.3). At this water content, the filter cake has a dry appearance and is easily friable. The sludge contains dirt, small quantities of insoluble inorganic salts, organic compounds and metals removed (dissolved) from the surface of workpieces or substrate and chemicals, including dissolved metals, carried over from the treatment processes. The dissolved metals are usually precipitated as hydroxides, including Fe(II) and Fe(III) hydroxides and oxides dissolved from steel substrates, or aluminium dissolved from the substrate in anodising precipitated as alumina. Phosphating process waste is mainly iron manganese or zinc phosphate. These can form large proportions of the sludge. The sludge is usually considered to be hazardous waste, and the industry produces in the order of 300000 tonnes of hazardous waste a year in Europe⁴ (approximately 16 tonnes a year per installation) [92, EC, 1991, 100, EC, 2000] and requires managing according to the appropriate regulations [93, EC, 2000, 103, EC, 1991].

Filter cake can be dried to a lower water content to reduce transport and disposal costs. It does however, become dusty when the water content is less than 40 %. See Section. 2.13.2.2.

The amount of sludge generated depends on the one hand on the condition of the workpieces, and on the other hand on specific process factors during the electroplating process.

The substantial factors are:

- input of pollutions
- erosion of metal oxides from the workpieces surface
- drag-out of process solution with the workpieces
- conversion from layers of metal, for example with chromating
- service lifetime of the process solutions.

From the quantity of the metals used in the electroplating shops in Germany and the drag-out occurring, the amount of electroplating sludge from all the galvanic shops can be estimated. Taking an annual metal usage of 20000 t/yr as a basis, with a drag-out rate of 20 %/t/yr, a metal loss of 4000 t can be calculated. Assuming that the metals are present as sulphates and are precipitated by means of classical lime precipitation:

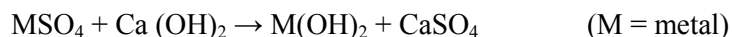

And presupposing that the sludge has a water content of 70 %, then the ratio of metal to sludge is a factor of roughly 1:10. This means approximately 10 tonnes of electroplating sludge result per tonne of lost metal. Consequently, in Germany 40000 t of electroplating sludge is generated by non-ferrous metal losses.

⁴ This derived from an industry estimate of <1 % of hazardous waste in Europe and the Eurostat figures from hazardous waste management in the EU-15.

An investigation on consumptions and emissions for 1998 - 2000 has been carried out in 13 nickel electroplating shops in northern Italy. All of the shops produce filter cake from batch pressure filters. The usual water content is about 70 % wt; the content of nickel in the sludges ranges between 1800 and 42000 mg/kg; the emission factor (nickel emitted to sludge/total nickel used) ranges between 40 and 80 g/kg (4 to 8 %) [112, Assogalvanica, 2003]. This is slightly less than the German ratio.

In addition to the German estimation, it is necessary to take into account the metals arising from the metal processes prior to electroplating, in particular pickling. Here, however, the estimation is difficult, since the condition of the delivered workpieces, which is an important factor, is unknown. In view of these uncertainties, the amount of electroplating sludge can be only estimated. For the total number of electroplating shops in Germany, 70000 to 80000 t/yr seems realistic.

In 2003, in Germany, approximately 30 % of the electroplating sludge was used as a secondary raw material in the non-ferrous metal industry. The remainder was disposed of in hazardous waste landfills. The efficiency of the non-ferrous metal in utilising the sludge is not taken into account: it is not 100 % and may be as low as 70 % [165, Tempany, 2004].

Some service solutions reaching the end of their life are disposed of directly as liquid wastes. They may be returned to the producers for recycling (for instance, copper etchants in printed circuit board manufacture) or managed off-site as hazardous liquid wastes, e.g. used process solutions containing cadmium, cyanides, autocatalytic nickel solution, and/or complexing agents, etc. [121, France, 2003].

3.3.3 Air emissions

Overall

The surface treatment of metals and plastics is not a major source of emissions to air [104, UBA, 2003] and these emissions are not a significant contribution to trans-boundary problems such as acid rain. However, local air quality may be an issue for some installations (for instance, NO_x in urban areas). Techniques and reasons for controlling emissions to air are discussed Section 4.15.

Some materials used in the processes have adverse health effects and their atmospheric concentrations in the workplace are usually controlled by health and safety legislation. Where workplace conditions and regulations require, these substances will need control, also by the techniques discussed in Section 4.15, such as by air extraction. Some substances may also be corrosive to buildings, equipment and workpieces or substrates in storage and require control to prevent unnecessary corrosion, damage and reworking (see Section 4.3.1.2).

Table 3.21 lists some substances and/or activities whose fugitive emissions may have local environmental impacts in some situations and are highlighted in the specific sections of Chapters 2 and 4.

Type of solution or activity	Solutions needing air extraction	
In all cases:		
Cyanide		
Cadmium		
Hexavalent chromium	Solutions which are used for electroplating, and/or are heated and/or are agitated with air	
Nickel solutions	Solutions agitated with air	
Ammonia	Solutions emitting ammonia, either where ammonia is a component or a breakdown product	
Dust producing activities such as polishing and finishing		
Using insoluble anodes	In all solutions hydrogen and/or oxygen are formed and there is a risk of deflagration, see individual processes and techniques in Chapters 2 and 4.	
Acid solutions		
	Solutions not needing extraction	Solutions needing extraction
Processes containing nitric acid with emissions of NO _x		Processes for the surface treatment of metals which are likely to result in the release into the air of any acid-forming oxide of nitrogen include: <ul style="list-style-type: none"> • chemical brightening of aluminium • bright dipping or chemical polishing of copper alloys • pickling using nitric acid, which may also contain hydrofluoric acid • in-situ cleaning using nitric acid • chemical stripping using nitric acid
Pickling and stripping using hydrochloric acid	Hydrochloric acid used at ambient temperatures and concentrations below 50 vol % technical grade with water generally does not evolve HCl gas or fumes which require extraction for health and safety reasons	Hydrochloric acid used at higher concentrations and/or at elevated temperatures generates significant releases of HCl gas or fume which requires extraction for health and safety reasons and to prevent corrosion in the workplace
Pickling and stripping using sulphuric acid	Sulphuric acid used at temperatures below 60 °C generally does not evolve acid mists which require extraction for health and safety reasons	Sulphuric acid used at temperatures above 60 °C releases a fine aerosol of the acid which requires extraction for health and safety reasons and to prevent corrosion in the workplace
Pickling using hydrofluoric acid		In all cases
Alkali solutions		
Aqueous alkaline cleaning	Alkaline cleaning chemicals are non-volatile and do not require fume extraction for health and safety reasons or local environmental protection	Alkaline cleaning tanks operating above 60 °C can generate significant amounts of water vapour which may be extracted for operator comfort and to prevent corrosion

Table 3.21: Solutions and activities which may require prevention of fugitive emissions

Information about air emissions data has been reviewed from several sources and is summarised in Table 3.22:

Source	Data type	Sample type
Austrian industry	Two large barrel lines	Regulatory measurements made for control by standard methods
CETS Netherlands	One installation (the same as in Section 3.3.1)	Regulatory measurements made for control by standard methods
CETS UK	One major chromium plating contractor	One regulatory measurement made by standard methods
Germany	Ten installations	
Sweden	Six installations, 14 sample points	Regulatory measurements made for control by standard methods

Table 3.22: Data sources and types for air emissions

Austrian industry

Examples of air emissions from two large production lines with three processes are given in Table 3.23.

Processes and emissions	Alkaline zinc barrel line		Copper/nickel barrel line	
	26 m ³ alkaline zinc bath with insoluble anodes		58 m ³ Watts type nickel	
Process type and size	16 baths in the process line	9 baths	18 baths	
Exhaust air treatment	Water scrubber	Cyanide air stream washed in an alkaline air scrubber	Extraction of water droplets to heat exchanger. Condensate to waste water treatment.	
Volume of emitted air Nm ³ /h	37700	27800	12200	
Zinc emitted mg/Nm ³	0.048 – 0.071			
Zinc load emitted g/h	2.2			
Copper emitted mg/Nm ³		<0.01		
Copper load emitted g/h		<2.78		
Cyanide emitted mg/Nm ³		0.11 – 0.16		
Cyanide load emitted g/h		3.75		
Nickel in the emitted air mg/Nm ³			<0.01 – 0.011	
Nickel load emitted g/h			0.134	
Dust emitted mg/Nm ³	<1 – 4.0	<1	<1	

Table 3.23: Emissions to air from alkali zinc barrel and copper-nickel barrel lines, Austria Collini GmbH, Austria

CETS Netherlands

Emission measurements taken during 2001 for regulation at a large contract surface treatment installation in the Netherlands are given in Table 3.24. The same installation supplied waste water emissions data given in Section 3.3.1.

Substance	Process details and comments	Measured value (mg/m ³)	Range (mg/m ³)	Flow m ³ /h
Nickel	Electroless nickel, with wet scrubber		0.014 - 0.039	2450
Copper	Air agitated bath 1.7m ³ , no scrubber	0.001		3320
Ammonia	Electroless nickel, with wet scrubber. Adding 1kg/h to process solution		<LoD - 9.2	
Cyanide	Nickel stripping	<LoD		No figure available
Cyanide	Silver cyanide, low temperature Agitation by pumps, no scrubbers		<LoD - 2.7	1847
HCl		1		
Chromium including CrVI)	Mainly hard chromium, using PFOS (2 kg/yr)	Cr(VI): five measurements at 0.0001	0.006 to 0.019 total Cr	2000
Ag		<LoD		
NOx	From stripping nickel from plastics (PDVF):			
	Before installation of wet scrubber		9033 to 35450	
	After installation		<500	
Note: LoD is limit of detection				

Table 3.24: Emission to air CETS Netherlands CETS VOM

CETS UK

Emissions to air from a large contract plating installation in the UK are given in Table 3.25. The samples were taken according to methods given in the Annex 8.4.1.2. The data relate to a trivalent chromium plating installation working 8 hour shifts.

Source	Hydrochloric acid tank 801 3x 0.9x0.9m ³	Hydrochloric acid tank 225 3x 0.9x 0.9m ³	Hydrochloric acid tank 100 3x 0.9x 0.9m ³	Hydrochloric acid with bright trivalent chromium 2.5x0.8x1.2 m ³	Black trivalent chromium 2.5x0.8x1.2 m ³
Emission abatement equipment	2 lip extraction No treatment	2 lip extraction No treatment	2 lip extraction No treatment	2 lip extraction No treatment	2 lip extraction No treatment
Flowrate (normalised) Nm ³ /h	4418	1907	6031	5600	7189
Total particulate matter mg/m ³	-			0.4	0.2
Chromium (total) mg/m ³	-			<0.01	<0.01
HCl mg/m ³	0.6	4.2	0.6	1.3	

Table 3.25: Emissions to air from trivalent chromium plating CETS UK (SEA)

The emissions from a UK aluminium brightening installation are described in Annex 8.12. The facility has automatic/semi-automatic brightening of aluminium prior to anodising. Processing line is alkaline soak clean/degrease; brightener; hot smut removal; anodising, with rinses between, using:

- brightening solution 6 - 7 % of 70 % nitric acid (as supplied)
- 15 % sulphuric acid (supplied as 96 %)
- 78 - 79 % phosphoric acid (supplied as 50 %).

Air is extracted at 30000 m³/h through a scrubber. Most NO₂ is absorbed, leaving mainly NO which is more difficult. Typical figures for NO_x emitted after water scrubbing are 60 - 70 mg/m³

Germany

Table 3.26 shows emission value for pickling plants and a hexavalent chromic plating line in Germany [104, UBA, 2003],[NRW UBA]. Additional parameters are given, such as exhaust air flowrate, composition of the pickles, etc. where this information is known. Simple emission control procedures were used, such as exhaust scrubbers with fill materials and countercurrent scrubbing or droplet separators. Note that each pickling plant differs in its pickling process chemistry-

A water scrubber is normally sufficient for NO_x (e.g. plant 5, Table 3.26). In order to reach the German TA Luft emission value for HF (3 mg/m³) an alkaline scrubber is usually necessary. As a consequence, where NO_x is discharged, then a very low value for NO_x is also reached (see plant 1, 2 and 10, Table 3.26). Plant 8 used HF and HNO₃ for the pickling baths; before they built their new plant and changed the composition of the baths, they had problems in reducing levels to <3 mg/m³ HF using a water scrubber without alkali. They now reach a low HF value and have eliminated NO_x as the solution no longer uses nitric acid.

HCl emission values in the range from 30 to 10 mg/m³ can generally be reached using a water scrubber. Values under 10 mg/m³ are attainable with a water scrubber, however with the disbenefits of significantly increased water consumption.

Very low emission values for Cr (VI) (0.001 - 0.011 mg/l) can be achieved using a mist eliminator/aerosol. Low levels for Ni can also be reached, but no data have been supplied.

Plant data	Plant 1	Plant 2	Plant 3	Plant 4	Plant 5	Plant 6	Plant 7	Plant 8	Plant 9	Plant 10
Type and size of baths	Pickling 8.2 m ³	Pickling >10 m ³	Pickling 22 m ³	Pickling ~50 m ³	Pickling 11 x 18 m ²	Pickling ~150 m ³	Pickling ~90 m ³	New plant pickling high grade steel: 22 m ³	Chromium plating: 25 m ³	Pickling 9.3 m ³
Edge exhaust				No	Exhaust air pipes			Yes	Yes	Yes
Exhaust airflow rate in m ³ /h	6500	<10000	12000	3000 - 6000	<8500	~50000	30000	4600 – 7460	2800	7000
Emission abatement and wash medium	Exhaust scrubbers; sodium hydroxide solution	Exhaust scrubbers; sodium hydroxide solution	None	Absorption chamber; water	Exhaust scrubbers; sodium hydroxide solution	None	Exhaust scrubbers water	No scrubber; only mist eliminator/aerosol separator	No scrubber; only mist eliminator/aerosol separator	Countercurrent wash tower with 3 plates and a mist eliminator; pH value is maintained at 9.0 with addition of KOH
Composition of the pickle										
Nitric acid %	20 - 40	<30	12	-	<40	Not known	Not known	None		15
Hydrofluoric acid %	<7	<2	4	5	<7	Not known	0	5 – 6.5		10
Sulphuric acid %								1.5 – 2		
Phosphoric acid %								0.5		
Picking additives	Nitrite		Nitrite, HF							
g CrO ₃ /l									250 – 260	
Management of baths								low temperature, no air agitation, no additives	Tenside as additives (not PFOS)	Temperature is about 70 °C

Plant data	Plant 1	Plant 2	Plant 3	Plant 4	Plant 5	Plant 6	Plant 7	Plant 8	Plant 9	Plant 10
Substance in mg/Nm ³										
NO _x	4 - 45	<15	21 - 29		15 - 40 (limit value 200) -	<12	<5			7 - 11
HF	0.04 - 0.06	<0.1	2 - 5	0.01 - 0.1		0.05 - 0.07		0.4 - 1.6		0.1 - 0.2
HCl						0.07 - 0.27	<0.4			
H ₂ SO ₄							<0.6			
NaOH							0			
NH ₃							<0.2			
CN ⁻						0.25 - 0.46				
CrVI (ions)						<0.1	<0.3			
Total chromium									0.001 - 0.011 (LoD 0.001)	
Ni	<0.003					<0.1				

Note: LoD = limit of detection

Table 3.26: Air emission values for examples of pickling and chromium plating plants in Germany [104, UBA, 2003],[Germany, NRW]

Sweden

Table 3.27 shows data from samples taken for regulatory reports for 2003 from five installations. Plants 1 to 4 carry out machining activities, and plants 5 and 6 have electroplating lines.

	Plant 1	Plant 2	Plant 3	Plant 4	Plant 5							Plant 6		
Process	Al foundry	Foundry	Machining		Zn II	CuSO ₄		Pickling	Zinc	Cyanide	Nickel	Zinc rack	Zinc barrel	Ni/Cr
Nm ³ /h												33100	2100	2400
Emissions in mg/Nm ³														
Hydrogen chloride					0.49 – 0.63			6.89 – 9.13	0.49 – 0.63		0.177 – 0.184	0.6 – 1.0	0.04 – 2.3	<0.3 – <0.4
SO _x as SO ₂					0.05 – 0.96	0.02 to 0.06			0.05 – 0.96		0.01 to 0.08	0.2 – 2.7	1.1 – 7.0	<0.3 – <0.4
NaOH												0.03 – 0.04	0.2 – 1.2	<0.01 – 0.09
Hydrogen cyanide										<0.01				
Cr(VI) and compounds as Cr														<0.01 – <0.01
Ni and its compounds as nickel				0.05 – 0.08 after filter							<0.04 – 0.06			<0.3 – <0.4
Particulate matter	1. After cleaning <5 2. Other emission sources <10	1.7 – 1.8	23.1 – 29.7 without cleaning											
Zinc					0.06 - 0.126				0.06 to 0.126			<0.01 to <0.01	0.08 to 0.46	
Copper						<0.005 to 0.012								

Table 3.27: Air emission values for examples of activities for the surface treatment of metals in Sweden [104, UBA, 2003]

3.3.3.1 Conclusions for emissions to air

Overall comments

The ranges of emissions discussed above and from large scale steel coil coating (Table 3.30 and Table 3.31) are summarised in Table 3.28. The emission ranges are for this sample of surface treatment plants only; each plant is associated with the data in the sections and tables and a range of BAT (for example, see Section 4.18). The values should be interpreted taking into account the comments below, and the guidance of the Monitoring BREF [91, EIPPCB,]. When considering a specific installation, the air emissions are only likely to be significant locally. It is important to take account of the overall load discharged, in addition to the concentration. In many cases, extraction is for health and safety inside the installation and not to gather fugitive emissions. Some of the low values reported for some substances result from the low emissions from processes and/or in-process measures: low values are not always associated with using end-of-pipe treatments.

The data generally show little variation between sources. This may be because the air emissions from this sector are not large and are easily dealt with using readily available in-process and/or end-of-pipe techniques discussed in Section 4.15. Also, air emission measurements are taken using standardised techniques that may not vary significantly between countries and regulatory systems (unlike water emission measurements, see Section 3.3.1).

The analysis of the data shows:

- some data provided have been provided in a summarised form, and some have not. In some cases, it is not clear if the data provided is from one sample, a composite or summarised from several samples
- it is not possible to draw overall conclusions about errors and the reliability, repeatability and accuracy of data, as well as confidence intervals
- in some cases, low values may have been included for substances that are not used in the process or installation being considered. However, they have been submitted as part of a prescribed group (or suite) of regulatory parameters
- each installation has differences which are not fully stated for:
 - the potential BAT used, particularly whether air agitation is used
 - size and throughput of the process being considered
 - chemicals used in the processes and their concentrations
 - the substrates being treated
 - waste air treatment
- few data are given for the:
 - type and age of the installations, significant processes or potential BAT used
 - percentage of full capacity of the production activity and control techniques at the time of sampling
 - relative contributions where air is extracted through the same sampling point from more than one production activity
 - geographic location and local environmental conditions.

The emission ranges associated with potential BAT derived here reflect the current performance of some installations in the sector (where data has been provided). However, they are not limit values (see the Preface and Chapter 5). Some typical emission limits for some European countries are given in Annex 8.3. The benchmark ranges in Table 3.28 largely fall within the limit values.

The emission ranges associated with potential BAT are for regulatory samples and the time intervals are specified in the standard methods used. These are often taken over a period of 30 to 60 minutes during operating time.

Comments on deriving ranges

Due to the uncertainties raised above, particularly that some low values may be due to the substance not being used, the bottom values of the ranges have been rounded up. The tops of some ranges have been rounded to appropriate figures, also to take account of uncertainties.

Oxides of nitrogen (total acid forming as NO₂)

The data sets for NO_x have widely different values: from Germany <5 to 45 mg/Nm³ to CETS Netherlands with <500 mg/Nm³. One installation reported in Germany has controlled NO_x from pickling by substituting a different process chemistry. The range for NO_x is wide but levels below 100 mg/l have been achieved in the UK when using scrubbers or adsorption towers, (see Annex 8.12).

Hydrogen fluoride

A range has been derived from the German pickling plant data.

Hydrogen chloride

Table 3.25 shows that low values may not be associated with waste gas treatment. The range includes data from CETS Netherlands and CETS UK, Germany and Sweden.

SO_x as SO₂

A range has been derived from the Swedish data.

NaOH

Data are given for one plant in Sweden. However, no method for determination was given and it is generally thought that where NaOH needs to be controlled, it is included in the dust limit value. No range associated with possible BAT has been derived.

Ammonia as N-NH₃

Data are for electroless nickel. No data are included for printed circuit board manufacture, where ammonia etching is frequently used and may be a significant source of ammonia in the sector.

Hydrogen cyanide

Low values could be achieved for one process by in-process measures: using a low temperature solution with pumped agitation (not air). A range has been derived from four sources and several processes. The lower end of the range is achievable with alkali scrubbers.

Zinc

A range has been derived with the data from Austria and Sweden.

Copper

A range close to the limits of detection has been derived with the data from Austria, CETS Netherlands and UK and Sweden.

Chromium and its compounds

A range has been derived for hexavalent chromium of <0.1 to 0.2 mg/Nm³. Total chromium figures are all below <0.1 mg/Nm³. The figure for total chromium should be greater than that for hexavalent, however, the figures are close to the limit of detection and this may account for the abnormality.

Nickel and its compounds

A range close to the limits of detection has been derived from three sources.

Particulate matter

The range is derived from three sources that include wet and dry processes. The range can be met in some circumstances without cleaning, although to achieve the lower end of the range for dry particulates cleaning may be necessary. The low end of the range for aqueous processes is usually achieved after wet or alkali scrubbing for other emissions.

Emissions mg/Nm ³	Jig or barrel activities					Large scale steel coil activities	Some emission ranges	Some techniques used to meet local environmental requirements associated with the emission ranges (see Table 3.21)
	Austria Table 3.23	CETS NL Table 3.24	CETS UK Table 3.25	Germany Table 3.26	Sweden Table 3.27			
Source								
Oxides of nitrogen (total acid forming as NO ₂)		<500		<5 – 45		nd <i>See Note 1</i>	<5 – 500	Scrubbers or adsorption towers
Hydrogen fluoride				<0.1 – 1.6			<0.1 – 2	Alkali scrubber
Hydrogen chloride			0.6 – 4.2		0.3 – 9.0	tin or chromium (ECCS) process 25 – 30	<0.3 – 30	Water scrubber <i>See Note 2</i>
SO _x as SO ₂					0.1 – 7.0	nd	1.0 – 10	Countercurrent packed tower with alkaline scrubber
NaOH					0.3 - 1.2	nd	No range derived	
Ammonia as N - NH ₃		0.1 – 9.2				nd	0.1 – 10	Note: Data is from electroless nickel. No data is given for PCB manufacture Wet scrubber
Hydrogen cyanide	0.11 – 0.16	LoD – 2.7		0.25 – 0.46	<0.1	nd	1) 0.1 – 3.0 2) 0.1 – 0.5	Non-air agitation Low temperature processes Non-cyanide processes The lower end of the range can be met by using an alkali scrubber
Zinc	0.05 – 0.07				<0.01 – 0.46	zinc or zinc nickel process 0.17 – 2.2	<0.01 – 2.5	Water scrubber <i>See Note 2</i>
Copper	<0.01	0.001			<0.005 – 0.012	nd	<0.01 – 0.02	<i>See Note 2</i>

Emissions mg/Nm ³	Jig or barrel activities					Large scale steel coil activities	Some emission ranges	Some techniques used to meet local environmental requirements associated with the emission ranges (see Table 3.21)
	Austria Table 3.23	CETS NL Table 3.24	CETS UK Table 3.25	Germany Table 3.26	Sweden Table 3.27			
Cr(VI) and compounds as chromium		Cr(VI) 0.006 – 0.02 Total Cr (5 results) 0.0001	Total Cr <0.01 – <0.01	Cr(VI) <0.01 – 0.11	<0.01 – <0.01	nd	Cr(VI) <0.01 – 0.2 Total Cr <0.1 – 0.2 <i>See Note 3</i>	Substitution for Cr(VI) by Cr(III) or non-chromium techniques Droplet separator Scrubbers or adsorption tower
Ni and its compounds as nickel	<0.01 – 0.01	0.014 – 0.04			<0.04 – 0.06	nd	<0.01 – 0.1	Extraction and condense in heat exchanger Water or alkali scrubber Filter <i>See Note 2</i>
Particulate matter			0.2 – 0.4		<5 – 29.7	tin or chromium (ECCS) process 1 – 20	<5 – 30	Wet scrubber Cyclone Filter (Values include where there is no treatment)
<p><i>Note 1: nd = no data provided</i></p> <p><i>Note 2: in some circumstances, some operators are meeting these ranges without EoP</i></p> <p><i>Note 3: The total Cr <0.1 – 0.2 is derived from the range of both measurements of Cr(VI) emissions and total Cr emissions</i></p>								

Table 3.28: Summary data for emission ranges to air from some installations

3.3.4 Noise

Internal noise issues are controlled by occupational health legislation.

External noise is a nuisance factor and depends on nearby targets, such as housing, other businesses, socially sensitive targets such as hospitals, public access, wildlife etc. Noise is usually measured as constant levels and peak levels are often compared with local background levels. Regulation often considers a maximum noise level and level additional to the local norm. Sometimes noise is also controlled by working hours permitted or giving different noise limits for different times of day and weekends, e.g. when people living or working locally will be most affected.

Activities that are especially noisy are identified in Sections 2.13.4 and 4.19. No values have been given for operating installations.

An example of a regulatory level being given as an addition to the background level is given in Annex 8.3 [121, France, 2003].

Vibration may also be considered along with noise as a local nuisance issue. It is more difficult to determine.

3.4 Consumptions and emissions and for other activities

3.4.1 Continuous electrolytic tin coating of steel and continuous electrolytic chromium coating of steel (ECCS)

The data in this section are based on information supplied from up to seven European lines. The data should be seen as typical data for this type of process and should not be seen as definitive.

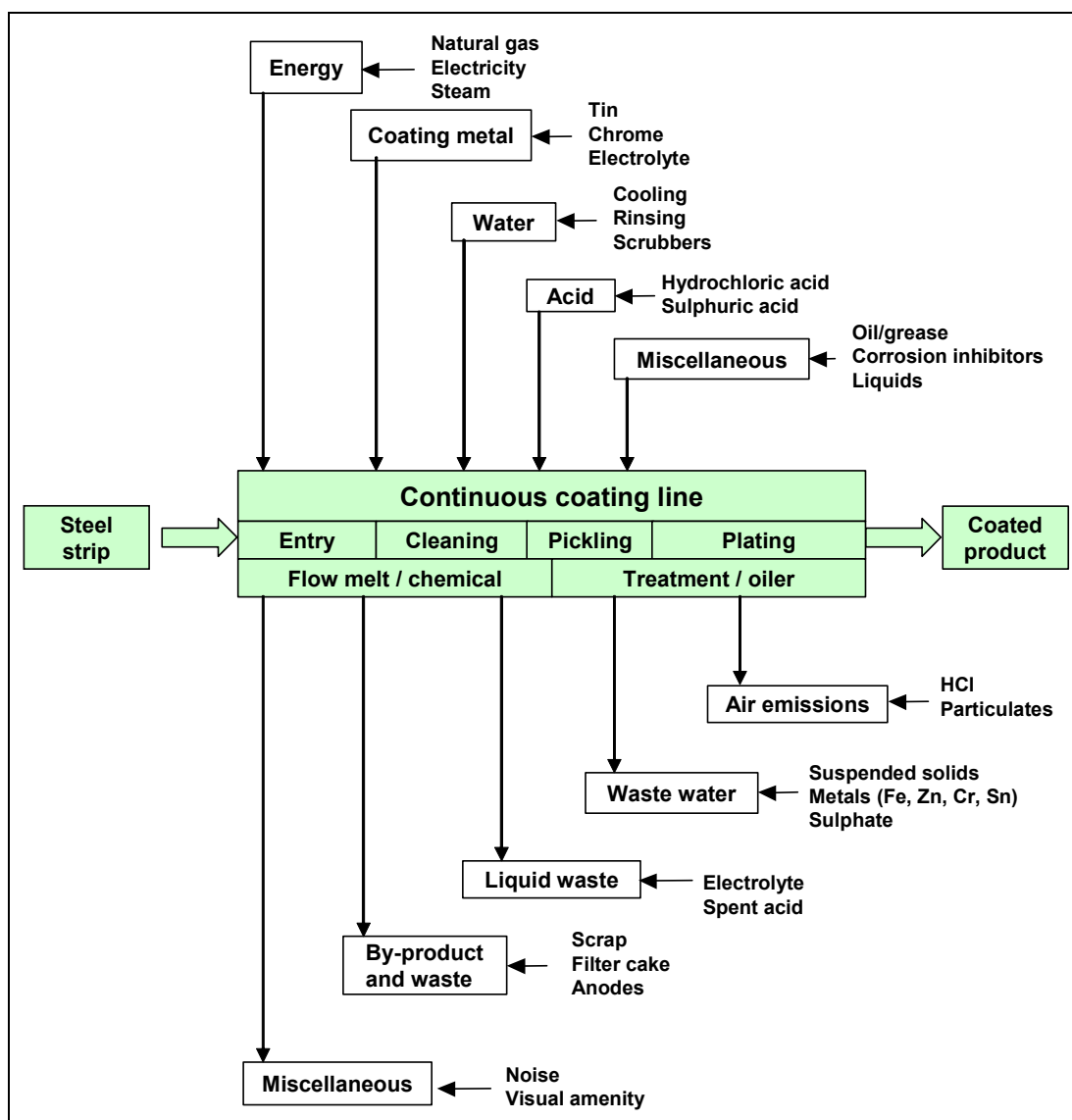

Figure 3.1: Continuous mass stream overview of tin plate and ECCS

Table 3.29 and Table 3.30 represent ranges in consumption and emission levels for the total coating lines. It should be noted that common site effluent treatment facilities (shared with other steel processing activities) are often used for these types of processes and hence limited data are available for final effluent discharges from individual coating lines. Due to the relatively low impact, only limited data are available for emissions to air.

Materials	
Tin plate – electrolyte tin	250 – 300 t/yr
	Composition 17 – 40 g/l – Sn
	10 - 28 g/l – SA
	3 - 5 g/l - ENSA
Chromate – sodium dichromate	40 - 50 t/yr
Energy	
Natural gas	26 - 40 MJ/t
Electrolyte	360 - 720 MJ/t
Steam	124 - 368 Kg/t
Water total	6.71 - 42.1 m ³ /t

Table 3.29: Typical input and consumption levels for continuous steel coating by electrolytic tin or ECCS

Specific emission	Typical range
To the air	
HCl	25 - 30 mg/Nm ³
Particulate (dry)	1 - 20 mg/Nm ³
To the water*	
Total suspended solids	4 - 40 mg/l
COD	120 - 200 mg/l
Iron	2 - 10 mg/l
Chromium	0.03 - 1 mg/l
Zinc	0.02 - 0.2 mg/l
Tin	0.03 - 1 mg/l
Chromium (VI)	0.0001 - 0.01 mg/l
To waste**	
Filter cake from effluent treatment	8000 - 14000 t/yr
*following waste water treatment and for several different production lines	
** wet and depending on production throughput	

Table 3.30: Typical emission values for continuous steel coating by electrolytic tin or ECCS

3.4.2 Continuous electrolytic zinc and zinc-nickel coating of steel

The data in this section are based on information supplied from up to 14 European lines. The data should be seen as typical data for this type of process and should not be seen as definitive values.

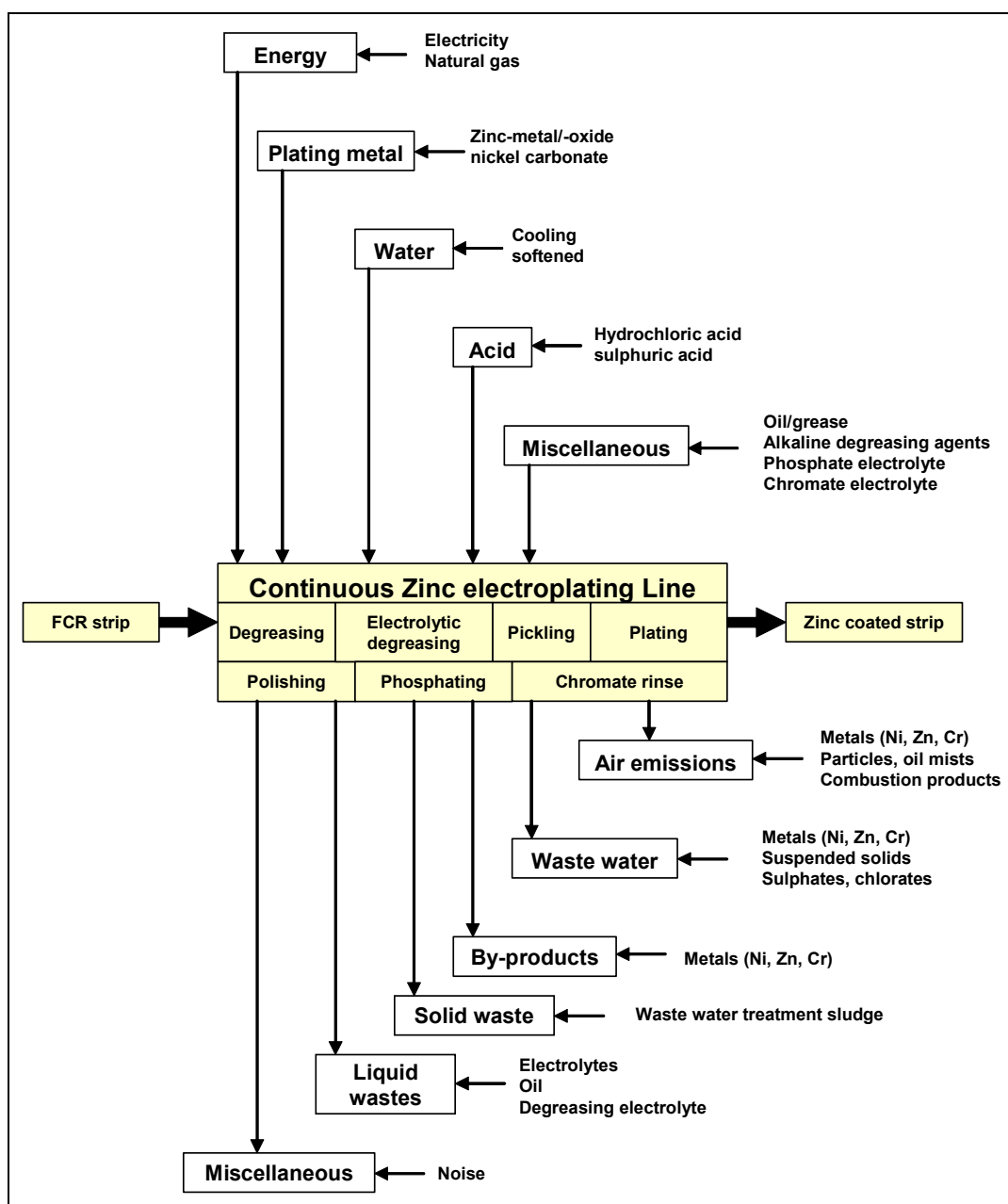

Figure 3.2: Continuous coating mass stream overview for zinc and zinc-nickel

Table 3.31 represents ranges in consumption and emission levels for the total coating lines. It should be noted that common site effluent treatment facilities (shared with other steel processing activities) are often used for these types of processes and hence limited data are available for final effluent discharges from individual coating lines. Due to the relatively low impact, only limited data are available for emissions to air.

Input/consumption level	
Energy (GJ/t plated steel)	
Electrical	0.4 to 1.5
Natural gas/steam	0.08 to 0.63
Materials (kg/t plated steel)	
Zinc	9.3 to 16.3
Nickel	0.7 to 1.3
Detergent	<0.45
Specific emissions	
Treated waste water (m ³ /t plated steel)	0.3 to 4.1
Released water	
To the air (mg/nm ³)	
Zinc	0.17 to 2.2
Nickel	-
To the water* (mg/l)	
Zinc	0.2 to 2.2
Nickel	-
Chromium	-
COD	-
Solid wastes ** (kg/t plated steel)	
Oily sludge	0.18
Filter cake	
Recycled/Valorised	
Metal	
Steel scrap	Recycled
Zinc anodes	Recycled (processes with soluble anodes)
Electrolyte	
Zinc electrolyte	Recycled (processes with soluble anodes)
* Following waste water treatment and for several different production lines	
** Wet and depending on the level of production throughput	

Table 3.31 Typical consumption and emission levels for continuous steel coating by zinc and zinc nickel

3.4.3 Printed circuit board manufacturing

3.4.3.1 Water consumption in PCB production

The specific consumption of water per m² PCB produced depends on the processes being applied (for instance, there will be increased consumption when manufacturing multilayer boards with a higher layer count and HDI boards). Therefore, the consumption can be a range between 170 and 600 l/m².

3.4.3.2 Raw materials and auxiliary products used and their potential disposal

[122, UBA, 2003] The following table gives a summary of substances used in the individual production steps, as well as the resulting emissions to air and water, as well as wastes produced.

Ref	Process step	Significant substances					Possible waste management route
		In the individual product	In the effluent of the process	In the exhaust air	Effluent resulting from air scrubbing	In the waste	
	Generation of phototools	Fixing: emulsions, ammonium thiosulphate, acidic acid, sodium sulphite, sodium tetraborate, aluminium sulphate, sulphuric acid Developer: potassium sulphite, potassium phosphate, hydroquinone, n-butyl diethanol amine	Fixing: emulsions, ammonium thiosulphate, acidic acid, sodium sulphite, sodium tetra borate, aluminium sulphate, sulphuric acid Developer: potassium sulphite, potassium phosphate, hydroquinone, n-butyl diethanol amine, silver	Acidic acid, sulphites		Silver	Good potential for recycling as silver can be retrieved
	Generation of sieves for screen printing, stripping	Emulsions, hypochlorite, iodine compound, halogen free solvent	Emulsions, hypochlorite, iodine compound	Hypochlorite, iodine compound			Disposal
	Treatment of surfaces	Copper clad laminate, aluminium, wood	Mechanical processes: abrasion of brush rollers, copper Chemical processes (micro etch, etch back, desmear): sodium persulphate, sulphuric acid, copper, hydrogen peroxide, sodium permanganate	SO ₂	SO ₂	Mechanical processes: drill dust (consisting of epoxy resin/glass fibre, copper, aluminium) Chemical processes: copper hydroxide, potassium sulphate	Mechanical processes: disposal Chemical processes: recycling in waste water equipment with recycling of sludge
	Brown oxide process	Hydrogen peroxide, sulphuric acid, copper compounds		SO ₂ vapours	SO ₃	Copper hydroxide	Recycling in waste water equipment with recycling of sludge
	Mechanical processing	Copper clad laminate		Dusts (epoxy resin and glass fibre)		Drilling and routing dust consisting of copper, glass fibre and epoxy resin Drill back boards made of aluminium and drill parts	Hazardous waste disposal recycling by specialised companies Return to manufacturer or disposal

Ref	Process step	Significant substances					Possible waste management route
		In the individual product	In the effluent of the process	In the exhaust air	Effluent resulting from air scrubbing	In the waste	
		Cut-to-size and processing of outline				Laminate and PCB waste	Recycling
Electroplating of PCBs							
	Plating in electroless copper process	Sulphuric acid, sodium persulphate, tin compounds, palladium, hydrochloric acid, formaldehyde, EDTA/tartrate/Quadrol, sodium hydroxide, copper compounds		HCl, SO ₂		Copper sulphide	Recycling in waste water equipment with recycling of sludge Recovery of palladium
	Direct plating	Thiophene derivate, sulphuric acid, potassium permanganate		SO ₂			
	Generation of primary image by screen printing or photo printing	Dry film, photo sensible screen printing inks	Polyacrylates, sodium carbonate	Acrylates		Sludge of solder mask Protective films (PE, PES), packing material, dry film, inks	Treatment of effluents with disposal of ink sludge Recycling of plastics and packing materials
	Electroplating of primary image	Sulphuric acid, sodium persulphate, tin sulphate, copper sulphate, hydrochloric acid, tetrafluoroboric acid, nitric acid		SO ₂ , HCl, NO _x		Copper hydroxide sludge, tin hydroxide sludge	Recycling in waste water equipment with recycling of sludge
	Stripping of photo resist and screen printing ink	Sodium hydroxide, polymerised acrylates	Polyacrylates, sodium hydroxide	Acrylates		Sludge of solder mask	Recycling in waste water equipment and disposal of sludge
Etching							
	Acidic, etching	Hydrochloric acid, copper compounds, hydrogen peroxide		Hydrochloric acid, copper compounds, hydrogen peroxide		Hydrochloric acid, copper compounds, hydrogen peroxide	Recycling of concentrates
	Alkaline, etching	Ammonium compounds, copper compounds		Ammonium compounds, copper compounds		Ammonium compounds, copper compounds	Recycling
	Stripping of metal resist	Nitric acid, metal compounds (tin)		NO _x		Metal compounds, especially tin hydroxide	Recycling in waste water equipment with recycling of sludge

Ref	Process step	Significant substances					Possible waste management route
		In the individual product	In the effluent of the process	In the exhaust air	Effluent resulting from air scrubbing	In the waste	
	Application of solder mask	Multifunctional acrylates, methoxypropylacetate, ketones, sodium carbonate	Monomeric and polymeric acrylates, sodium carbonate	Halogen free solvent (MPA)		Sludge of solder mask	Recycling in waste water equipment with recycling of sludge
	Hot air levelling	Tin-lead alloy, hydrogen bromide, polyethylene glycol	Bromide, tin, lead	Polyethylene glycol (decomposition products)		Polyethylene glycol (decomposition products), tin-lead dross	Hazardous waste incineration Recycling
	Nickel/gold surface	Sodium peroxide sulphate, sulphuric acid, hydrochloric acid, nickel salt, sodium phosphite, organic acids, gold salt		HCl, SO ₂		Nickel, gold, sulphate	Selective ion exchange with subsequent refining of gold, precipitation in waste water equipment with recycling of sludge
	Organic surface passivation	Acidic acid, imidazole derivate, ammonium compounds		CO ₂ , NO _x , NH ₄	Acidic acid, ammonium		Effluent treatment

Table 3.32: Printed circuit boards: summary of types of consumptions and waste outputs

3.4.3.3 Waste water from PCB production

As similar techniques to control emission to water are used for PCB production, the discussion and conclusions in Section 3.3.1 are applicable. Typical regulatory discharge limit values from PCB production to both public sewer and watercourses are shown in Annex 8.3.

3.4.3.4 Waste from PCB production

Wastes arising from the various process steps are described in the relevant sections in Section 2.11.

Table 3.33 below states the maximum quantities of the most common wastes occurring during the production of PCBs (per 1000 m² surface produced), with their possible management routes, and indicative Hazardous Waste List (HWL) numbers [100, EC, 2000]. The quantities are highly dependent on the production programme, types and designs of board produced and the treatments of wastes and effluents.

PCB wastes arising	Indicative HWL Number	Possible waste management routes	Maximum quantity (kg/1000 m ²)
Sludges which may contain hazardous substances from physico-chemical treatment	11 01 09	Recycling	2500
Sludges from an in-house water treatment plant	11 01 09	Disposal	1000
Acidic pickling agents	11 01 05	Recycling	3000
Alkaline pickling agents	11 01 07	Recycling, use in reconditioned replenisher	2500
Bare PCB (without Au), wastes originating of outline processing	16 03 04	Recycling	1500
Bare PCB (with Au)	16 03 04	Recycling	100
Drill back material	12 01 05	Disposal/return	1000
Drilling and routing dust	12 01 05	Disposal	600
Drill entry boards		Recycling	800
Solder mask sludge and dry resist of photo print dept.	08 01 16 08 01 18	Material recycling, thermal disposal	900
Protective films PP/PE	150102	Recycling	400
Precious metals/metals (Ag, Au, Cu, Ni, Pd, Sn/Pb)	11 01 99	Recycling, significant compensation by refineries	<100 - 500

Table 3.33: Wastes arising from PCB manufacture

3.4.3.5 Air emissions from PCB production

Substances to be expected in the various processes are shown in Table 3.34 below: As similar techniques to control emissions to air are used for PCB production, the discussion and conclusions in Section 3.3.3 are applicable

Process	Substances
Direct plating	Formaldehyde, manganese, copper and sulphuric acid as aerosol
Plating	Sulphuric acid, nitric acid, hydrogen fluoride and nitrogen oxides
Etching and stripper	Ammonia, copper aerosol, hydrogen chloride, and nitrogen oxides
Hot air levelling equipment	C_{total} , aldehydes, lead and tin
Immersion tin plating	Tin, sulphuric acid, methyl sulphonic acid and thiourea
Plasma treatment to clean drill holes	Adsorption of radicals by gas scrubbing necessary
Solder masks	C_{total} and CO

Table 3.34: Air emissions from PCB production

Thermal or catalytic air scrubbing may be required to ensure the C_{total} levels meet regulatory requirements.

4 TECHNIQUES TO CONSIDER IN THE DETERMINATION OF BAT

This chapter sets out techniques considered generally to have potential for achieving a high level of environmental protection in the industries within the scope of the document. Management systems, process-integrated techniques and end-of-pipe measures are included, but a certain amount of overlap exists between these three when seeking the optimum results.

Prevention, control, minimisation and re-cycling procedures are considered as well as the re-use of materials and energy

Techniques may be presented singly or as combinations to achieve the objectives of IPPC. Annex IV to the Directive lists a number of general considerations to be taken into account when determining BAT and techniques within this chapter will address one or more of these considerations. As far as possible a standard structure is used to outline each technique, to enable comparison of techniques and an objective assessment against the definition of BAT given in the Directive.

The content of this chapter is not an exhaustive list of techniques and others may exist or be developed which may be equally valid within the framework of BAT.

Generally a standard structure is used to outline each technique, as shown in Table 4.1:

Type of information considered	Type of information included
Description	Technical description of the technique
Achieved environmental benefits	Main environmental impact(s) to be addressed by the technique (process or abatement), including emission values achieved and efficiency performance. Environmental benefits of the technique in comparison with others
Cross-media effects	Any side-effects and disadvantages caused by implementation of the technique. Details on the environmental problems of the technique in comparison with others
Operational data	Performance data on emissions/wastes and consumption (raw materials, water and energy). Any other useful information on how to operate, maintain and control the technique, including safety aspects, operability constraints of the technique, output quality, etc.
Applicability	Consideration of the factors involved in applying and retrofitting the technique (e.g. space availability, process specific)
Economics	Information on costs (investment and operation) and any possible savings (e.g. reduced raw material consumption, waste charges) also as related to the capacity of the technique
Driving force for implementation	Reasons for implementation of the technique (e.g. other legislation, improvement in production quality)
Example plants	Reference to a plant where the technique is reported to be used
Reference literature	Literature for more detailed information on the technique

Table 4.1: Information breakdown for each technique described in this chapter

Key issues for the implementation of IPPC in this sector are:

- effective management systems
- efficient raw material, energy and water usage
- optimised use of chemicals in processes and directly related activities
- the substitution by less harmful substances
- minimisation, recovery and recycling of waste
- the prevention of environmental accidents and minimisation of their consequences.

Individual sections may address more than one of these issues. Good management systems, both production and environmental are central to fully addressing integrated pollution prevention and control issues in the surface treatment of metals and plastics. Important issues for management systems to achieve optimum effect are:

- being constructively self-critical
- production and environmental systems implemented as entirely complementary to each other
- inclusion of audits for energy and water usage, as well as raw material consumption
- the design and operation of installations to negate the impact of unplanned releases, both chronic and acute.

4.1 Management techniques

4.1.1 Environmental management tools

Description

The best environmental performance is usually achieved by the installation of the best technology and its operation in the most effective and efficient manner. This is recognised by the IPPC Directive definition of ‘techniques’ as *“both the technology used and the way in which the installation is designed, built, maintained, operated and decommissioned”*.

For IPPC installations an Environmental Management System (EMS) is a tool that operators can use to address these design, construction, maintenance, operation and decommissioning issues in a systematic, demonstrable way. An EMS includes the organisational structure, responsibilities, practices, procedures, processes and resources for developing, implementing, maintaining, reviewing and monitoring the environmental policy. Environmental Management Systems are most effective and efficient where they form an inherent part of the overall management and operation of an installation.

Within the European Union, many organisations have decided on a voluntary basis to implement environmental management systems based on EN ISO 14001:1996 or the EU Eco-management and audit scheme EMAS. EMAS includes the management system requirements of EN ISO 14001, but places additional emphasis on legal compliance, environmental performance and employee involvement; it also requires external verification of the management system and validation of a public environmental statement (in EN ISO 14001 self-declaration is an alternative to external verification). There are also many organisations that have decided to put in place non-standardised EMSs.

While both standardised systems (EN ISO 14001:1996 and EMAS) and non-standardised (“customised”) systems in principle take the *organisation* as the entity, this document takes a more narrow approach, not including all activities of the organisation e.g. with regard to their products and services, due to the fact that the regulated entity under the IPPC Directive is the *installation* (as defined in Article 2).

An environmental management system (EMS) for an IPPC installation can contain the following components:

- (a) definition of an environmental policy
- (b) planning and establishing objectives and targets
- (c) implementation and operation of procedures
- (d) checking and corrective action
- (e) management review
- (f) preparation of a regular environmental statement
- (g) validation by certification body or external EMS verifier
- (h) design considerations for end-of-life plant decommissioning
- (i) development of cleaner technologies
- (j) benchmarking.

These features are explained in somewhat greater detail below. For detailed information on components (a) to (g), which are all included in EMAS, the reader is referred to the reference literature indicated below.

(a) Definition of an environmental policy

Top management are responsible for defining an environmental policy for an installation and ensuring that it:

- is appropriate to the nature, scale and environmental impacts of the activities
- includes a commitment to pollution prevention and control
- includes a commitment to comply with all relevant applicable environmental legislation and regulations, and with other requirements to which the organisation subscribes
- provides the framework for setting and reviewing environmental objectives and targets
- is documented and communicated to all employees
- is available to the public and all interested parties.

(b) Planning, i.e.:

- procedures to identify the environmental aspects of the installation, in order to determine those activities which have or can have significant impacts on the environment, and to keep this information up-to-date
- procedures to identify and have access to legal and other requirements to which the organisation subscribes and that are applicable to the environmental aspects of its activities
- establishing and reviewing documented environmental objectives and targets, taking into consideration the legal and other requirements and the views of interested parties
- establishing and regularly updating an environmental management programme, including designation of responsibility for achieving objectives and targets at each relevant function and level as well as the means and timeframe by which they are to be achieved.

(c) Implementation and operation of procedures

It is important to have systems in place to ensure that procedures are known, understood and complied with, therefore effective environmental management includes:

- (i) Structure and responsibility
 - defining, documenting and communicating roles, responsibilities and authorities, which includes appointing one specific management representative
 - providing resources essential to the implementation and control of the environmental management system, including human resources and specialised skills, technology and financial resources.

(ii) Training, awareness and competence

- identifying training needs to ensure that all personnel whose work may significantly affect the environmental impacts of the activity have received appropriate training.

(iii) Communication

- establishing and maintaining procedures for internal communication between the various levels and functions of the installation, as well as procedures that foster a dialogue with external interested parties and procedures for receiving, documenting and, where reasonable, responding to relevant communication from external interested parties.

(iv) Employee involvement

- involving employees in the process aimed at achieving a high level of environmental performance by applying appropriate forms of participation such as the suggestion-book system or project-based group works or environmental committees.

(v) Documentation

- establishing and maintaining up-to-date information, in paper or electronic form, to describe the core elements of the management system and their interaction and to provide direction to related documentation.

(vi) Efficient process control

- adequate control of processes under all modes of operation, i.e. preparation, start-up, routine operation, shutdown and abnormal conditions
- identifying the key performance indicators and methods for measuring and controlling these parameters (e.g. flow, pressure, temperature, composition and quantity)
- documenting and analysing abnormal operating conditions to identify the root causes and then addressing these to ensure that events do not recur (this can be facilitated by a ‘no-blame’ culture where the identification of causes is more important than apportioning blame to individuals).

(vii) Maintenance programme

- establishing a structured programme for maintenance based on technical descriptions of the equipment, norms etc. as well as any equipment failures and consequences
- supporting the maintenance programme by appropriate record keeping systems and diagnostic testing
- clearly allocating responsibility for the planning and execution of maintenance.

(viii) Emergency preparedness and response

- establishing and maintaining procedures to identify the potential for and response to accidents and emergency situations, and for preventing and mitigating the environmental impacts that may be associated with them.

(d) Checking and corrective action, i.e.:

(i) Monitoring and measurement

- establishing and maintaining documented procedures to monitor and measure, on a regular basis, the key characteristics of operations and activities that can have a significant impact on the environment, including the recording of information for tracking performance, relevant operational controls and conformance with the installation's environmental objectives and targets (*see also the Reference document on Monitoring of Emissions*)
- establishing and maintaining a documented procedure for periodically evaluating compliance with relevant environmental legislation and regulations.

(ii) Corrective and preventive action

- establishing and maintaining procedures for defining responsibility and authority for handling and investigating non-conformance with permit conditions, other legal requirements as well as objectives and targets, taking action to mitigate any impacts caused and for initiating and completing corrective and preventive action that are appropriate to the magnitude of the problem and commensurate with the environmental impact encountered.

(iii) Records

- establishing and maintaining procedures for the identification, maintenance and disposition of legible, identifiable and traceable environmental records, including training records and the results of audits and reviews.

(iv) Audit

- establishing and maintaining (a) programme(s) and procedures for periodic environmental management system audits that include discussions with personnel, inspection of operating conditions and equipment and reviewing of records and documentation and that results in a written report, to be carried out impartially and objectively by employees (internal audits) or external parties (external audits), covering the audit scope, frequency and methodologies, as well as the responsibilities and requirements for conducting audits and reporting results, in order to determine whether or not the environmental management system conforms to planned arrangements and has been properly implemented and maintained
- completing the audit or audit cycle, as appropriate, at intervals of no longer than three years, depending on the nature, scale and complexity of the activities, the significance of associated environmental impacts, the importance and urgency of the problems detected by previous audits and the history of environmental problems – more complex activities with a more significant environmental impact are audited more frequently
- having appropriate mechanisms in place to ensure that the audit results are followed up.

(v) Periodic evaluation of legal compliance

- reviewing compliance with the applicable environmental legislation and the conditions of the environmental permit(s) held by the installation
- documentation of the evaluation.

(e) Management review, i.e.:

- reviewing, by top management, at intervals that it determines, the environmental management system, to ensure its continuing suitability, adequacy and effectiveness
- ensuring that the necessary information is collected to allow management to carry out this evaluation
- documentation of the review.

(f) Preparation of a regular environmental statement:

- preparing an environmental statement that pays particular attention to the results achieved by the installation against its environmental objectives and targets. It is regularly produced – from once a year to less frequently depending on the significance of emissions, waste generation etc. It considers the information needs of relevant interested parties and it is publicly available (e.g. in electronic publications, libraries etc.).

When producing a statement, the operator may use relevant existing environmental performance indicators, making sure that the indicators chosen:

- i. give an accurate appraisal of the installation's performance
- ii. are understandable and unambiguous
- iii. allow for year on year comparison to assess the development of the environmental performance of the installation
- iv. allow for comparison with sector, national or regional benchmarks as appropriate
- v. allow for comparison with regulatory requirements as appropriate.

(g) Validation by certification body or external EMS verifier:

- having the management system, audit procedure and environmental statement examined and validated by an accredited certification body or an external EMS verifier can, if carried out properly, enhance the credibility of the system.

(h) Design considerations for end-of-life plant decommissioning

- giving consideration to the environmental impact from the eventual decommissioning of the unit at the stage of designing a new plant, as forethought makes decommissioning easier, cleaner and cheaper
- decommissioning poses environmental risks for the contamination of land (and groundwater) and generates large quantities of solid waste. Preventive techniques are process-specific but general considerations may include:
 - i. avoiding underground structures
 - ii. incorporating features that facilitate dismantling
 - iii. choosing surface finishes that are easily decontaminated
 - iv. using an equipment configuration that minimises trapped chemicals and facilitates drain-down or washing
 - v. designing flexible, self-contained units that enable phased closure
 - vi. using biodegradable and recyclable materials where possible.

(i) Development of cleaner technologies:

- environmental protection should be an inherent feature of any process design activities carried out by the operator, since techniques incorporated at the earliest possible design stage are both more effective and cheaper. Giving consideration to the development of cleaner technologies can for instance occur through R&D activities or studies. As an alternative to internal activities, arrangements can be made to keep abreast with – and where appropriate – commission work by other operators or research institutes active in the relevant field.

(j) Benchmarking, i.e.:

- carrying out systematic and regular comparisons with sector, national or regional benchmarks, including for energy efficiency and energy conservation activities, choice of input materials, emissions to air and discharges to water (using for example the European Pollutant Emission Register, EPER), consumption of water and generation of waste.

Standardised and non-standardised EMSs

An EMS can take the form of a standardised or non-standardised (“customised”) system. Implementation and adherence to an internationally accepted standardised system such as EN ISO 14001:1996 can give higher credibility to the EMS, especially when subject to a properly performed external verification. EMAS provides additional credibility due to the interaction with the public through the environmental statement and the mechanism to ensure compliance with the applicable environmental legislation. However, non-standardised systems can in principle be equally effective provided that they are properly designed and implemented.

Achieved environmental benefits

Implementation of and adherence to an EMS focuses the attention of the operator on the environmental performance of the installation. In particular, the maintenance of and compliance with clear operating procedures for both normal and abnormal situations and the associated lines of responsibility should ensure that the installation’s permit conditions and other environmental targets and objectives are met at all times.

Environmental management systems typically ensure the continuous improvement of the environmental performance of the installation. The poorer the starting point is, the more significant short-term improvements can be expected. If the installation already has a good overall environmental performance, the system helps the operator to maintain the high performance level.

Cross-media effects

Environmental management techniques are designed to address the overall environmental impact, which is consistent with the integrated approach of the IPPC Directive.

Operational data

No specific information reported.

Applicability

The components described above can typically be applied to all IPPC installations. The scope (e.g. level of detail) and nature of the EMS (e.g. standardised or non-standardised) will generally be related to the nature, scale and complexity of the installation, and the range of environmental impacts it may have.

Economics

It is difficult to accurately determine the costs and economic benefits of introducing and maintaining a good EMS. A number of studies are presented below. However, these are just examples and their results are not entirely coherent. They might not be representative for all sectors across the EU and should thus be treated with caution.

A Swedish study carried out in 1999 surveyed all 360 ISO-certified and EMAS-registered companies in Sweden. With a response rate of 50 %, it concluded among other things that:

- the expenses for introducing and operating EMS are high but not unreasonably so, save in the case of very small companies. Expenses are expected to decrease in the future
- a higher degree of co-ordination and integration of EMS with other management systems is seen as a possible way to decrease costs
- half of all the environmental objectives and targets give payback within one year through cost savings and/or increased revenue
- the largest cost savings were made through decreased expenditure on energy, waste treatment and raw materials
- most of the companies think that their position on the market has been strengthened through the EMS. One-third of the companies report increasing revenue due to EMS.

In some Member States reduced supervision fees are charged if the installation has a certification.

A number of studies⁵ show that there is an inverse relationship between company size and the cost of implementing an EMS. A similar inverse relationship exists for the payback period of invested capital. Both elements imply a less favourable cost-benefit relationship for implementing an EMS in SMEs compared to larger companies.

According to a Swiss study, the average cost for building and operating ISO 14001 can vary:

- for a company with between 1 and 49 employees: CHF 64000 (EUR 44000) for building the EMS and CHF 16000 (EUR 11000) per year for operating it
- for an industrial site with more than 250 employees: CHF 367000 (EUR 252000) for building the EMS and CHF 155000 (EUR 106000) per year for operating it.

These average figures do not necessarily represent the actual cost for a given industrial site because this cost is also highly dependent on the number of significant items (pollutants, energy consumption,...) and on the complexity of the problems to be studied.

A recent German study (Schaltegger, Stefan and Wagner, Marcus, *Umweltmanagement in deutschen Unternehmen - der aktuelle Stand der Praxis*, February 2002, p. 106) shows the following costs for EMAS for different branches. It can be noted that these figures are much lower than those of the Swiss study quoted above. This is a confirmation of the difficulty to determine the costs of an EMS.

Costs for building (EUR):

minimum - 18750
maximum - 75000
average - 50000

Costs for validation (EUR):

minimum - 5000
maximum - 12500
average - 6000

A study by the German Institute of Entrepreneurs (Unternehmerinstitut/Arbeitsgemeinschaft Selbständiger Unternehmer UNI/ASU, 1997, *Umweltmanagementbefragung - Öko-Audit in der mittelständischen Praxis - Evaluierung und Ansätze für eine Effizienzsteigerung von Umweltmanagementsystemen in der Praxis*, Bonn.) gives information about the average savings achieved for EMAS per year and the average payback time. For example, for implementation costs of EUR 80000 they found average savings of EUR 50000 per year, corresponding to a payback time of about one and a half years.

External costs relating to verification of the system can be estimated from guidance issued by the International Accreditation Forum (<http://www.iaf.nu>).

⁵ E.g. Dyllick and Hamschmidt (2000, 73) quoted in Klemisch H. and R. Holger, *Umweltmanagementsysteme in kleinen und mittleren Unternehmen – Befunde bisheriger Umsetzung*, KNI Papers 01/02, January 2002, p 15; Clausen J., M. Keil and M. Jungwirth, *The State of EMAS in the EU. Eco-Management as a Tool for Sustainable Development – Literature Study*, Institute for Ecological Economy Research (Berlin) and Ecologic – Institute for International and European Environmental Policy (Berlin), 2002, p 15.

Driving forces for implementation

Environmental management systems can provide a number of advantages, for example:

- improved insight into the environmental aspects of the company
- improved basis for decision-making
- improved motivation of personnel
- additional opportunities for operational cost reduction and product quality improvement
- improved environmental performance
- improved company image
- reduced liability, insurance and non-compliance costs
- increased attractiveness for employees, customers and investors
- increased trust of regulators, which could lead to reduced regulatory oversight
- improved relationship with environmental groups.

Example plants

The features described under (a) to (e) above are elements of EN ISO 14001:1996 and the European Community Eco-Management and Audit Scheme (EMAS), whereas the features (f) and (g) are specific to EMAS. These two standardised systems are applied in a number of IPPC installations

Examples from site visits are:

- CROPU S.A., Burgos Spain: ISO 14000
- SIKEL N.V, Genk, Belgium: ISO 14001
- Société de Galvanoplastie Industrielle (SGI), Plaisir, France
- Exhall Plating, Ltd., Coventry, UK: EMAS and ISO 14001. Direct costs reduced by GBP 500000 in seven years.

In this sector, the application of an EMS (and whether the EMS is a standardised one) is often a customer-requirement.

Reference literature

(Regulation (EC) No 761/2001 of the European parliament and of the council allowing voluntary participation by organisations in a Community eco-management and audit scheme (EMAS), OJ L 114, 24/4/2001, http://europa.eu.int/comm/environment/emas/index_en.htm).

(EN ISO 14001:1996, <http://www.iso.ch/iso/en/iso9000-14000/iso14000/iso14000index.html>; <http://www.tc207.org>)

4.1.1.1 Specific EMS issues for surface treatment activities

Specific EMS issues that may be relevant are:

- installing valves and numbering them for all pipes. The numbers are then used in instructions for shutdown sequences, both long and short-term shutdown
- checking all tanks and pipework regularly for leakage. This requires tank bottoms and pipes to be visible, with no accrual of dirt, rubbish, old jigs, anode ends, etc. in contained areas and around tanks or pipes
- using fixed and temporary pumps, hydraulic fluid systems and filters over mobile tanks or drip trays with sufficient capacity to retain leakage and spills. Pipe ends are kept over the process tank or drip trays. This enables liquid residues to be collected and returned to the correct process solutions or dealt with as a waste or waste water
- keeping all process areas clean and painted to allow chronic leakage to be readily identified
- the use of high level alarms in both process vats and waste water treatment where overflow is possible [125, Ireland, 2003]
- the management of the chemicals and proprietary products for their correct use, and especially the identification of risks associated with the storage and use of incompatible materials [125, Ireland, 2003]
- the identification of the use of priority pollutants in the installation (used currently and in the past). This may also be required for compliance with legislation controlling priority pollutants, see Annex 8.1 in the Water Framework Directive (2000/60/EG) [113, Austria, 2003]. Priority pollutants are also identified by PARCOM [12, PARCOM, 1992]. Key examples for this sector are:
 - polychlorinated biphenyls, e.g. in capacitors and other electrical equipment
 - cadmium
 - other materials that do not or are slow to degrade, such as other metals in soluble form (such as nickel, chromium, zinc, copper, lead)
 - VOCs used for degreasing (including C10 - C13 chloralkanes)
 - cyanides
 - acids and alkalis
- the establishment of the use of the land and buildings of the installation prior to the existing installation and/or activities and if the activities carried out could be confused with the activities of the surface treatment installation
- the self - monitoring of indicators for environmental performance as well as those affecting individual processes. Examples are:
 - effluent discharged and quality, see Annex 8.4.2 [56, France, 2003, 121, France, 2003]
 - raw material consumption by type
 - energy consumption
 - water consumption
 - waste produced and type.

These figures are most meaningful when related to other relevant production parameters, such as area of workpiece or substrate throughput, number of barrels or flight bars processed, weight of workpieces or substrate processed, etc.

4.1.2 Reduction in reworking by process specification and quality control

Description

Workpieces or substrate surface treated incorrectly, to the wrong or inappropriate specification, or a specification incorrectly applied can lead to significant amounts of metal stripping and rectification (in barrel and jig work) as described in Section 2.3, metal stripping. Workpieces and/or substrate may also have to be scrapped, predominantly large scale coils and printed circuit boards, although some jig and barrel processed workpieces may be damaged irrecoverably.

Reduction in reworking and scrap can be achieved in a variety of ways, such as using formal quality management systems, QMS. As with environmental management tools, described in Section 4.1.1, to achieve success within the installation, it is good practice to ensure these systems are formally recorded and disseminated to the workforce. While many such systems are externally accredited (and this may be a customer requirement) it may not be essential. However, it is usual to have the system externally audited, to provide unbiased input to validate and update the system, as well as giving customer confidence. These systems usually include statistical process control (SPC).

Attention to the appropriate process specification and its quality control is also an important factor. In surface treatment activities a 'right first time approach' is normally anticipated and is often part of a formal system. To achieve this, it is common practice to ensure the correct process is applied in the correct manner to achieve the desired effect. This requires a proper understanding of the properties given by the surface treatment and the subsequent operations to be performed on the workpiece or substrate such as pressing, forming, bending, crimping, drilling, welding, soldering, etc. Other techniques that form part of achieving the correct specification are discussed in EMS (Section 4.1.1) and in production management systems, such as ISO 9000

To match the treatment to the required objective, environmental and/or quality management systems (as appropriate) can make sufficient provision for dialogue and agreement between the operator and the customer about the correct process specification, engineering design drawings and the quality control measurement points for the workpieces and/or substrates (see Applicability, below). The following are examples of areas that can be addressed:

- surface treatments can alter the dimensions of a workpiece by the thickness of layer added (e.g. changing the size of threaded components), the characteristics of the substrate (e.g. hydrogen embrittlement with acid zinc plating) or be inappropriate for subsequent manipulation (e.g. some finishes may be brittle and may flake when a treated workpiece is subsequently bent or crimped)
- in electrolytic processes where the applied material is current-carrying, the deposits build preferentially at edges and corners of the workpiece and/or substrate, where the charge density is greatest. The method of measurement and the points to be measured for quality control of the finish may be agreed taking account of the differences of thickness at different parts of the workpiece or substrate to be finished. Some measurement methods require flat surfaces and to meet performance requirements attention may need to be given the coating thickness being significantly thinner in flat areas than at the edges (a ratio of centre thickness to edge thickness of approximately 1:3 or 1:4). Also, while specifications may be met in the flat, measured areas, edge build-up can result in flaking if the edges are subsequently manipulated, such as by crimping
- performance specifications (such as to achieve a specified level of corrosion resistance) are preferable to total reliance on prescriptive specifications. The more usual and readily applied thickness measurements are best used in conjunction with performance specifications, when thicknesses at agreed points that meet the specified performance can be established (see also the discussion on Substitution, Section 4.9)

- alterations to the manufacturing process prior to surface treatment. For example, change in pressing oils (to a type which may become pressed into the substrate micro-structure and does not respond to normal degreasing processes), type of substrate, pressing workpieces in place of machining, hardening prior to surface treatment, etc.
- alterations to end use specification
- barrel treatment instead of jig (possibly because of cost constraints)
- major organisations or industry sectors requiring large amounts of surface treatment may write their own specifications (such as automotive or aerospace organisations). Smaller organisations often use these publicly available specifications. To meet specifications, take care to ensure the latest versions are referred to, and the specifications are suitable for other products, their subsequent processing and end use
- some customers may request the highest quality specifications available, such as military and aerospace specifications involving cadmium for other products. However, military and aerospace applications are exempt from marketing and use legislation applying to cadmium.

There are many ways in which processes can be improved for stability and consistency over time and many techniques described in Chapter 4 have this advantage as well as improving environmental performance. Where this occurs, it is highlighted in the section 'Driving force for implementation'. Examples are the use of insoluble anodes with external make-up (see Section 4.8.2), process solution agitation (Section 4.3.4) and control of concentration of process chemicals (Section 4.8.1).

Achieved environmental benefits

Avoiding reworking minimises losses in raw material, energy and water inputs, as well as minimising waste water treatment and the generation of sludge and liquid acid wastes.

Metal stripping with strong acids is often carried out as a batch process. Reduction in this activity can result in reductions in:

- spillage which can attack concrete floors and can pollute surface and groundwaters
- exceeding waste water treatment plant capacity leading to breach of permit discharge conditions
- acid fumes and mists leading to problems with local air quality, health and safety and deterioration of plant and equipment.

Reduction in surface treated scrap can reduce emissions to air from other installations such as furnaces and foundries. In these, some non-ferrous metals may be vaporised and organic coatings burnt off with unknown breakdown products.

Cross-media effects

There are no negative cross-media effects.

Operational data

If specification or processing is incorrect, a significant proportion of production capacity may be affected.

In some cases, workpieces and/or substrates are damaged in the reworking, or cannot be reworked and are scrapped.

Applicability

Applicable to all installations. However, note that the IPPC Directive applies to the installation and its management systems. It does not apply to the supply chain and products.

Economics

There is significant economic justification for ensuring the specification is correct and is met, thus preventing reworking. Avoiding reworking is a positive action towards sustainable manufacturing and increases process throughput efficiency, as well as increasing customer confidence. There are cost savings in raw materials, hazardous waste disposal, energy and water, as well as labour. For sub-contract installations, the cost of stripping and reworking is usually borne by the sub-contractor.

Conversely, there are costs associated with introducing and maintaining process management systems and SPC.

Driving force for implementation

Business economics and sustainability.

Customer requirements for quality management systems.

Example plants

All sites visited have quality management systems; some accredited, but all externally assessed. Examples are: SIKEL N.V., Genk, Belgium; Exhall Plating, Coventry, UK; SGI, Plaisir, France; Corus, Llanelli, UK; Cropu SA, Burgos, Spain.

Reference literature

[11, Tempany, 2002, 18, Tempany, 2002]

4.1.3 Benchmarking**Description**

Benchmarking is the systematic recording of inputs (raw materials, energy and water) and outputs (emissions to air, water and as waste), and the regular comparisons of these with previous data for the installation, with its sector, national or regional benchmarks see Section 4.1.1(j). Appropriate benchmarking requires comparable data – a “like for like” comparison. For surface treatment activities this would be best achieved on a surface area treated basis or other consumption or throughout basis. For instance, kg of zinc used per 10000 m² of surface, kg zinc discharged per 10000 m² of surface, kWh per 10000 m² of surface.

The surface area for stamped or pressed parts, or parts fabricated from the same thickness of substrate can be calculated [145, LeCarre, 2004] as follows:

$$S = \frac{\text{weight (kg)}}{\text{density (kg/m}^3\text{)} \times e \text{ (m)}}$$

Where: S = surface area , e = thickness and m = metres

The Solvent Emissions Directive [97, EC, 1999] gives a formula for calculating the surface area for the vehicle coating industry and other coated parts made from sheets (note the factor ‘2x’ for coating both sides):

$$\frac{2 \times \text{total weight of product shell}}{\text{average thickness of metal sheet} \times \text{density of metal sheet}}$$

Variables can make such data difficult to acquire accurately: for instance, workpieces have irregular shapes and varying thicknesses so estimations of surface area can vary in accuracy, and thickness of deposited coatings can vary widely [124, Germany, 2003]. However, these difficulties do not prevent the gathering of data to be used as Section 4.1.1(j) describes (see Table 3.5). Designs produced electronically by CAD can also be a source of deriving areas.

When data is benchmarked in an installation, it is good practice to maintain a system to action the data, including:

- identifying a person or persons responsible for evaluating and taking action on the data
- informing those responsible for plant performance, including alerting operators, rapidly and effectively to variations from normal performance
- other investigations to ascertain why performance has varied or is out of line with external benchmarks.

Examples of benchmarking methods and applications are given below. Where sector, national or regional data is gathered, it can be made public while keeping individual site identities confidential:

Installation

One company electroplating or phosphating complex-shaped parts uses five barrel lines, all with barrels of the same size. Water inputs are metered at every input point. Barrel movements are recorded per flight bar. All data, such as raw material consumption, water and power consumption etc are then related to flight bar movements, and tracked and compared on a regular basis to monitor plant performance and costs.

Sector

In the UK, the Surface Engineering Association conducts a national survey of members to benchmark costs, etc.

Regional

Data envelope analysis (DEA) is a method of analysis that has been developed to compare the efficiency of organisational units when it is difficult to make the inputs or outputs comparable with unambiguous quantities. It can be applied in situations in which there are observations from many relatively homogeneous production units. In this context, homogeneity refers to the inputs and outputs that the units produce. They do not need to be organised in the same way or use the same types of production technology.

An example of DEA applied to surface treatment is given in Data variables from a survey of 15 electroplating companies were analysed in four groups:

- quantity of workpiece/substrate outputs
- labour and capital invested in equipment
- energy and water consumption
- emissions.

The DEA results were calculated using a varying combination of input factors. The efficiency score (productive efficiency) was calculated for inputs in capital and man-hours, water and energy with various outputs to the environment. The only output quantifier was the annual revenue earned by treatment. The data was modelled using linear programming methods with weighting factors.

Examples are also given for steel coil coating in Section 3.3.4

Achieved environmental benefits

Assists individual installations to assess their environmental performance with other installations. Assists in identifying techniques used by the best performing installations.

Cross-media effects

None.

Operational data

Provides benchmarks and assessment of operational environmental performance for installations and techniques.

Applicability

Data must be available for several installations with homogeneity of inputs and outputs before an individual installation can be benchmarked. The breadth of data and installations needs to be sufficiently wide to be challenging; for example, [8, Nordic-Council, 2002] benchmarks water usage at 50 litres per m². The UK industry median is about 44 litres per m² (verbal information from TWG) and the French regulatory maximum is 8 litres per m² per rinsing operation which equates to 40 litres per m² for a 5-process line (see Section 3.2.2) [58, France, 2003].

Weighting factors need to be determined. Knowledge of DEA and its application with linear programming is required. This approach may be useful for a group of companies or a trade association. The technique does not readily take account of cross-media effects.

Economics

DEA may need expert assistance for application.

Optimisation of the plant environmental performance will usually achieve economic optimisation.

Driving force for implementation

Benchmarking is also commensurate with good economic performance. Benchmarking and optimising environmental performance (such as raw material, water and power inputs, as well as material losses) will achieve economic optimisation at the same time.

Example plants

Unnamed examples are given by, [8, Nordic-Council, 2002] Oekepol and Eurofer.
Regional/sector schemes: Ford-BOS (e.g. Frost Electroplating Ltd., Birmingham, UK)
Installations: Exhall Plating Ltd., Coventry, UK e.g. m³ per barrel line per shift,
Metal Colours Ltd., Slough, UK: e.g. kWh/kg Zn
SIKEL N.V., Genk, Belgium: e.g. efficiency of zinc utilisation (>95 %).

Reference literature

Installation and national sector: [18, Tempany, 2002], [127, Oekepol, 2003],
Regional: [8, Nordic-Council, 2002], [19, Eurofer, 2003]

4.1.3.1 Benchmarking water consumption**Description**

In France, a benchmark value for water usage of 8 l/m²/rinse stage was introduced in 1985 in legislation applying to all surface treatment installations with a total volume of treatment tanks of more than 10m³.

Achieved environmental benefits

This benchmark reduces the water usage and the waste water treatment requirements, prevents dilution of effluents and reduces the flux (weight per day) of materials lost.

Cross-media effects

These depend on the water-reduction techniques used.

Operational data

Once determined, it need only be checked periodically. It is not a routine limit value, and that some key measures to achieve this value, such as number of rinses in a cascade, can only be changed periodically, see Section 4.7. Other measures can be used to control variables, such as conductivity meters on rinse tanks as well as flow-meters and restrictor valves on each point of water use: these are important factors in achieving the range, and maintaining the values, see Section 4.4.5.

Only the volume of water leaving the plant is measured, therefore avoiding problems with calculating evaporation, added liquid solutions, how much water is recycled, etc. This discharge figure accounts for all water used, except for domestic-type usage (toilets, canteens, etc.).

The values for individual rinsing stages (or the component steps) are not calculated, only the total volume against the total number of rinse stages for the installation. This allows for some rinsing stages to use more water than others, according to operational needs.

There is difficulty in calculating the surface area, see Section 4.1.3, but in 80 – 90 % of cases the operator knows this for commercial reasons, or can determine this. In some cases, operators can determine and use a surrogate measure; for example, by running the process for a set period using the most geometrically simple components and measuring the water discharged, at the same time measuring another consumption or throughput factor (e.g. power usage, number of jigs or barrels, number or weight of parts, chemicals or anode consumption, etc). The amount of water discharged is then related to this secondary throughput or consumption factor. This secondary factor can subsequently be used to re-check the benchmark value against more geometrically intricate components.

The surface area is the simple geometric wetted surface. It includes all surfaces of the supports moving through the rinses, i.e. barrels (inside and outside surfaces) and jigs.

A stage is all the tanks in one rinsing operation after a process or associated activity. It may be one or multiple tanks, and multiple tanks used in cascade rinsing significantly reduce water usage (as described in Section 4.7), see Figure 4.1.

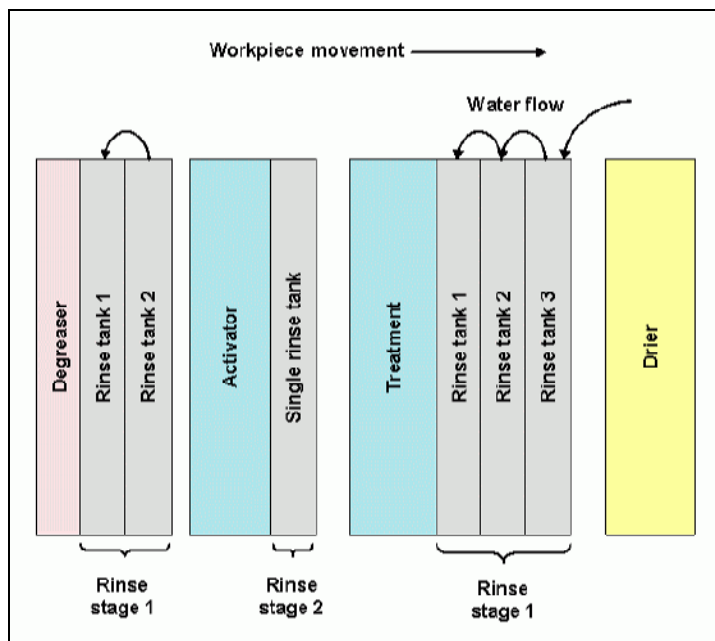

Figure 4.1: Definition of rinse stage

Applicability

This has been successfully used in 80 % of French installations since 1985. Water usage may be higher in very high specification activities such as PCB production (see Section 3.4.3.1).

Economics

This benchmark can reduce investment costs (particularly for raw water and waste water treatment) and running costs (particularly for raw materials and water).

Driving force for implementation

Reducing water flow through the process is crucial, not only for water saving, but can be used with drag-out controls to reduce raw material usage and increase materials efficiency. This also reduces the size of waste water treatment plant needed and the treatment chemicals and energy used in treatment.

Example plants

80 % of French surface treatment installations.

Reference literature

[58, France, 2003], [121, France, 2003], [165, Tempany, 2004]

4.1.4 Process line optimisation**Description**

Calculating the theoretical inputs and outputs required for selected options, such as those given in Sections 4.4.2, 4.4.4.2, 4.6 and 4.7 is useful to benchmark the installation's environmental and economical performance. While this can be carried out manually, it is tedious and time consuming. Software modelling tools can be used to help optimise performance of process lines by making recalculations easier and quicker. They can be written for processes by external contractors or in-house, and may be general or bespoke for a specific installation.

One software tool is based on an Excel spreadsheet and has a series of parameters for rack and barrel zinc electroplating. The calculations used in the spreadsheet are the same as, or similar to, the ones quoted in this BREF, and other similar information, including standard financial calculations. An example calculation is given in Annex 8.11. One data set is held for a 'good practice' plant (the SE2000 model plant) and the other set initially to a UK industry average plant called the 'benchmark' (this is not 'benchmark as used in this BREF, but means the current level of practice). The example given shows the costs of changing from an industry average to a 'good practice' plant using several improvement options described in Chapter 4 of this BREF.

As an example, using the software shown in Annex 8.11 the difference in a typical zinc and passivation barrel line and one optimised using various BAT techniques:

- Typical line: 11500 m³ water usage per year
- Optimised line: 2951 m³ water usage per year, a saving of 74 %

The input data for the 'industry average' (benchmark) plant can be adjusted to an actual plant for benchmarking, or used to examine the effects of various options, such as adding rinsing stages, evaporators, or changing processes, etc.

While the software is set for zinc plating, all the variables, such as chemical make-up type, and all input and output costs can be varied, so the software can be used for other processes, either complete lines such as for copper plating, or to judge the effects of changing one activity.

Achieved environmental benefits

Enables a process line to be optimised theoretically for consumption of water, energy and conservation of raw materials, as well as minimising emissions to water.

Cross-media effects

Enables optimisation of inputs (raw materials and utilities) and emissions to water at the same time.

Operational data

Can use existing data and can be used to benchmark performance as well as plan improvements.

Applicability

For this example, the 'front-end' (visible page in the software) shows zinc electroplating, but the same calculations can readily be adapted by the user to other surface treatment activities, by entering simple, appropriate data in the model. It can therefore be used for all multistage process lines, or individual sub-processes.

While financial data is shown in GBP this is purely symbolic, all financial data can be entered as if in other currencies for calculation.

The programme does not optimise the whole installation.

Other manual or software packages can be used or built, sometimes for a specific plant, see example, below.

Economics

The software referred to is free of charge.

Trialling options using software can assist with process management and investment decisions before commitment.

As an example, Annex 8.11 shows a payback time for optimising a zinc and passivation barrel line, (without infrastructure work) = 0.6 years, based on savings in water, raw materials and reject reworking.

Driving force for implementation

Environmental optimisation can optimise the plant's process and economic performance.

Example plants

A general example is shown in Annex 8.11 of a non-optimised installation and an installation using various potential BAT techniques agreed with British industry is used as a comparison in the software.

For optimisation by bespoke software, Sikel N.V. Genk, Belgium

Reference literature

[26, Envirowise, 2003]

4.1.5 Real time process control

Description

Digital process control systems collect data and react to maintain predetermined process values in real time.

Achieved environmental benefits

Improved plant efficiency and product quality as well as lowering the emissions.

Cross-media effects

None.

Applicability

Many continuous electroplating lines

Economics

For coil coating, the initial investment is EUR>0.8/t installed with operating and maintenance costs of EUR>0.8/t installed.

Driving force for implementation

Process efficiency and quality requirements.

Example plants

CROPU S.A., Burgos, Spain, SIKEL N.V., Genk, Belgium.

Reference literature

[19, Eurofer, 2003, 73, BSTSA,]

4.2 Installation design, construction and operation

4.2.1 Pollution prevention from unplanned releases – planning, design, construction and other systems

Description

Section 1.4.2 identifies the sector as still having the potential to cause environmental accidents, or unplanned releases. A planned, integrated approach can decrease this, starting with the identification of those aspects of an installation that may have significant impacts on the environment. The identified risks are then tackled by careful design and construction, as well as by management systems that address the prevention, mitigation and management of accidents and emergencies, and the breaches of permit conditions.

Regulatory and/or good practice systems for pollution prevention are in use in some countries, for example, see Reference literature, below. Many installations in the sector have benefited from the introduction of such techniques. The following activities are key examples where these techniques reduce the frequency and impacts of acute and chronic pollution of surface and groundwaters and soil, and make the operations more cost effective:

- routine and non-routine maintenance including maintenance of solutions, see Section 4.11
- delivery and storage of raw materials, see Section 4.2.2
- process control, process and environmental monitoring, see Section 4.1.

Key issues for delivery and storage of consumable raw materials are identified in Section 2.1.2 and environmental or health effects from chemicals are identified in Section 1.4.4. The BREF on emission from the storage of chemicals also discusses these issues [23, EIPPCB, 2002]. In surface treatment activities, the process solutions are usually kept in open tanks with connecting pipework in situations analogous to the storage of chemicals and many of the same techniques can be applied, such as double skinned tanks or contained areas.

Some key aspects of preventing pollution given in the Reference literature are:

- the identification of hazards and pathways
- a simple ranking of hazard potential
- a three step implementation of actions for pollution prevention:
 - primary measures (structural)
 - sufficient plant dimensions
 - selection of sealing materials where chemicals are stored or handled, e.g. for flooring, contained areas
 - stability of the process line and components (including temporary and infrequently used equipment, such as pumps and tanks used for occasional maintenance operations)
 - secondary measures (plant or equipment)
 - containment (or secondary containment) refers to additional protection against storage tank releases over and above the inherent protection provided by the tank container itself (in this sector, the tanks may be for storage or production). There are two major types of secondary containment for leakages, namely those that are part of the tank construction, such as, double tank bottoms (only for aboveground tanks), double skinned and double walled tanks and impervious barriers which are placed upon the soil surface below the tanks
 - correct specification of size and strength of tanks to receive pumped-out liquors (see also stability, in primary measures, above)
 - leak identification systems
 - tertiary measures (management systems)
 - inspections, external experts and internal including regular maintenance emergency plans for potential accidents (see Section 4.1.1)
 - test programmes.

The identification of pathways and targets for the environmental effects can determine the choice of site, plant and equipment as well as design and construction of the infrastructure and plant.

Achieved environmental benefits

Particularly useful in minimising contamination of soil and groundwater by routes that are not readily visible and are difficult to identify.

Facilitates site decommissioning.

Minimisation of unplanned chronic and acute discharges to surface waters as well as municipal waste water treatment systems.

Cross-media effects

No adverse implications.

Operational data

Careful planning and design utilising operational experience can make routine operation, maintenance and monitoring easier, cheaper and environmentally safer.

Single skinned tanks within a contained area are as secure as a double skinned tank; and any leakage is easy to find earlier than within a double skinned tank. Containment and capacity are discussed in the Reference literature (below): to fulfil its intended function the contained area must be able to contain an expected spillage or leak and, as an example, the contained or banded volume is often 110 % of the volume of the largest tank contained within it. The contained area can be a sealed area draining to either a big vat under the process tanks or a floor with a chemical-resistant coat (within raised walls or drains or the floor is sloped to drains). During cleaning or maintenance the contents (of the contained area) may be connected to (or, pumped to) the appropriate waste water stream, but to ensure operational control of any spillages, the connection should be operated under supervision, see Section 4.1.1.

Applicability

These measures can be considered for all installations; however they are best implemented at the proposal and initial design and build stages. Many changes can be incorporated in major upgrades, while some improvements can be made to existing installations during normal maintenance periods, although retrospective improvement may be more difficult, and may not be as effective. Various standards and guidance can also form part of longer term planning for plant improvements.

Economics

These are part of the investment costs with initial investments or upgrades. Some techniques may be no-cost options at a new build or upgrade stage. Often costs can be recovered by more efficient working, maintenance, and the avoidance of costs for dealing with accidents and breaches of permit.

Driving force for implementation

Business duty of care and possible liability for any environmental damage arising.

Example plants

Widely used in many countries.

Reference literature

[16, RIZA, 1999, 19, Eurofer, 2003, EIPPCB, 2002 #23, 23, EIPPCB, 2002, 42, SEA, 2001, 81, INRS, 1998]

4.2.1.1 Oil tight trays

Description

Leakage of oil from hydraulic systems is a specific pollution prevention problem controlled by the use of oil tight trays.

Achieved environmental benefits

Environmental benefit is medium, by minimising the possible release of oil to soil, surface water, groundwater and soil.

Cross-media effects

None.

Operational data

The trays require checking and emptying as part of a maintenance programme. Significant and/or repeated amounts of oil accumulating indicate maintenance problems with the hydraulic system.

Applicability of the BAT

New and existing plants with significant hydraulic systems.

Economics

Installation costs for large scale coil plants are EUR 0.001 - 0.15/t and operating costs are EUR 0.001 - 0.15/t.

Driving force for implementation

Efficient, clean and safer working environment (prevents slips by workforce).

Reference literature

[19, Eurofer, 2003]

4.2.2 Storage of chemicals

Description

See Section 2.1.2, and for more detailed information, Section 4.2.1 and the Storage BREF [23, EIPPCB, 2002]. Many other documents also advise on good practice (for examples, see Reference literature, below).

The key issues are to:

- avoid generating free cyanide gas by storing acids and cyanides separately
- store acids and alkalis separately
- reduce the risk of fires by storing flammables and oxidising agents chemicals separately
- reduce the risk of fire by storing in dry conditions, and separately to oxidising agents, chemicals which are spontaneously combustible when damp. Mark the storage area of these chemicals to avoid the use of water in fire-fighting
- avoid the contamination of soil and water environments from spillages and leakages of chemicals
- avoid or prevent the corrosion of storage vessels, pipework, delivery systems and control systems by corrosive chemicals and fumes from their handling.

Achieved environmental benefits

Reduction of unplanned releases to the environment, particularly from fire-fighting.

Cross-media effects

None reported.

Operational data

Requires management of chemicals as they are delivered and used.

Applicability

All sites.

Economics

Construction costs of separate and/or contained storage areas.

Driving force for implementation

Occupational health legislation, EMS and other management systems, Seveso Directive [142, EC, 1996] and water legislation, as well as PARCOM [12, PARCOM, 1992].

Example plants

CROPU S.A., Burgos, Spain

Reference literature

[16, RIZA, 1999, 19, Eurofer, 2003 October, 23, EIPPCB, 2002, VITO, 1998 #20, Agences de l'Eau, 1996 #82, 42, SEA, 2001, 79, Loire-Bretagne, 1985, 81, INRS, 1998]

4.2.3 Process line type and construction

Description

Process line type is generally prescribed by various factors (see the introduction to Section 2).

The use of horizontal in-line production lines is ideal for PCB production, with the exception of the generation of the primary images and etch resists. These lines often contain modules that can be integrated.

Coils also lend themselves to integrated production lines, on both small and large scale.

In some installations it is possible to produce an encapsulated integrated surface treatment line (see Figure 4.2), or integrate the surface treatment into the overall production (see Section 6.1).

Achieved environmental benefits

No fugitive air emissions in the installation.

High process control reduces chemical and water usage.

Cross-media effects

None.

Operational data

The precision automatic movement of components and high accuracy plating reduces process time and improves quality.



Figure 4.2 Encapsulated integrated chromium plating line
[140, Atotech, 2003]

Applicability

For new build installation and lines. Most applicable where the parts have a high consistency of shape and size, such as shock absorber (automotive damper) piston rods, PCBs, and coils of steel and aluminium, etc.

Economics

High capital cost.

Driving force for implementation

Improved workplace environment.

Low production labour costs.

High precision and quality.

Example plants

Monroe, ZF-Sachs, Arvin in US and Europe.

Sikel N.V., Genk, Belgium

Figure 4.2.

See Section 6.1.

Reference literature

[122, UBA, 2003]

4.3 General operational issues

4.3.1 Protection of workpieces and substrates - before and after treatment

Corrosion can take place on metal substrates prior to surface treatment and on treated surfaces of metals and plastics after surface treatment and prior to dispatch. Corrosion may cause poor adhesion of the surface treatment or damage decorative finishes and therefore require stripping and reworking or scrapping. Corroded products are likely to require additional processing to remove corrosion prior to surface treatment. Corrosion prevention can reduce the environmental impacts associated with stripping and reworking (see Sections 2.3).

Most metal surfaces oxidise or corrode when exposed to oxygen or other factors in the atmosphere. Corrosion time is dependent on the type of material and the conditions under which the material is stored, for instance, steel components do not corrode in an atmosphere with less than 50 % humidity. Humidity, temperature and acid atmospheres are factors determining how quickly corrosion takes place. All these factors are present in surface treatment installations, so controlling the exposure of stored products is important.

Protection of surfaces from mechanical damage is also important.

4.3.1.1 Shortening storage time

Description

Eliminating or shortening storage between operations, e.g. between manufacture and surface treatment, or between surface treatment and dispatch, can avoid the need for other corrosion prevention treatment. This may be as part of a formal JIT (just in time) system or as part of good production planning.

Achieved environmental benefits

Prevention of stripping and reworking.

Applicability

Most applicable for in-house installations and where transport links are short and frequent. However, this may not be applicable where customers are distant and economic transport batch sizes require storage before and after processing.

Economics

The only foreseen costs are labour costs for planning and supervision of production and delivery timing. Reduced capital and running costs for storage, as well as production costs for stripping and reworking reject products.

Driving force for implementation

See Economics, above.

Example plants

Reference literature

[3, CETS, 2002] [118, ESTAL, 2003].

4.3.1.2 Storage and transport conditions**Description**

It is usual to store components both awaiting treatment and treated away from humid and acid air associated with many surface treatment installations. Good ventilation of the workplace will assist (see design, Section 4.2), as will ensuring the vented moist, and often acid, exhaust air does not come into contact with products in storage or awaiting transport. Ventilation of the storage areas may also be used provided that it reduces moisture and does not draw in moist and acid air. Moisture condenses on components which become chilled during transport or storage and are subsequently delivered to a warm, humid location. Keeping products warm in transport and storage in a low humidity environment can eliminate these problems.

Achieved environmental benefits

Reduced stripping and reworking.

Cross-media effects

Increased energy usage for dehumidification or ventilation may be offset by environmental benefits from decreased reworking.

Applicability

All locations. However, detailed application will vary with regional climatic conditions such as normal humidity levels and daily mean temperatures.

Economics

Increased costs of energy usage for dehumidification or ventilation may be offset by savings from reworking. The discounted capital cost of segregating storage may need to be balanced with add-on measures such as improved dehumidification or ventilation.

Driving force for implementation

Economic and environmental savings from reduced stripping and reworking.

Example plants

SIKEL N.V., Genk, Belgium.

Reference literature

[3, CETS, 2002]

4.3.1.3 Packaging**Description**

Workpieces or substrates may be packed with absorbent or corrosion preventing materials such as specialist papers or woodchips. Such materials can both prevent corrosion and prevent surface damage in transit and are often specified by the customer, particularly for high value components, such as printed circuit boards and aerospace components. Coils are usually protected by the outer layers, with a protective strip providing immediate contact with flooring and cradles preventing unwanted movement.

Achieved environmental benefits

Reduced stripping and reworking.

Cross-media effects

Increased consumption of raw materials. This can be offset by selecting and using recyclable packaging systems.

Applicability

Can be considered in all applications, but costs will be limiting for low added value components.

Economics

Increased costs of packaging materials and labour may be offset by savings from reworking.

Driving force for implementation

See Economics, above.

Customer quality requirements.

Example plants

Sikel N.V., Genk, Belgium; Corus, Trostre Works, Llanelli, UK; SGI, Plaisir, France.

Reference literature

Site visits to example plants.

4.3.1.4 Corrosion prevention coating with oil or grease

Description

Oil and/or grease may be used for corrosion prevention during storage. The disadvantage is that items have to be cleaned (see Section 2.3). When choosing the type of oil or grease, the degree of protection required needs to be considered. However, this must be balanced with Section 4.3.2, below.

Achieved environmental benefits

Prevention of reworking and scrapping.

Cross-media effects

Increased chemical, energy and water usage to remove oil and/or grease.

Increased disposal to waste water and waste routes.

Operational data

Greases are often used for military applications when components are left in storage for long periods prior to use. The duration of coating becomes significant when cleaning the components at a later date. Long storage times especially during warm weather complicate cleaning.

Pure mineral oils are generally easier to remove compared with emulsions and vegetable-based products. Vegetable-based oils and greases are often promoted as environmentally friendly products, however these can be very difficult to remove especially if the product has been stored during a warm weather period. This may be a more important factor in warmer regions.

Applicability

Suitable in some applications and often associated with minimising tool wear in pressing, etc.

Economics

The environmental and economic savings from the avoidance of stripping, reworking or scrapping may offset or exceed the costs of avoiding corrosion.

Driving force for implementation

Economics, see above.

Customer requirements.

Reference literature

[3, CETS, 2002]

4.3.2 Minimisation and optimisation of coatings from previous mechanical treatments - oil and grease

Description

Oil or grease is used to minimise tool wear, e.g. pressing sheet steel, drilling or drawing operations, or for corrosion prevention prior to surface treatment and therefore the choice of cleaning method begins early in the production process. Degreasing operations prior to surface treatment can often be simplified by manufacturing and storing components in the correct way rather than using excessive oil or grease. Some oils used in pressing can be ground into the metal surface and are resistant to cleaning.

Any changes to remove or minimise oily coatings often take place at the mechanical production stage. This may involve discussion with the customer (see Section 4.1.2, Specifications). By changing the production method the use of oil can be minimised or eliminated. Oil usage can be minimised by regularly assessing the application methods, type and quantity of oil used. Oil that is compatible with the subsequent cleaning system should be used. Possibilities for reduction of oil and grease applied in the mechanical production areas are included:

- use of volatile lubricants
- employment of minimal quantity cool lubrication
- dripping off and/or centrifuging the workpieces
- pre-cleaning the workpieces at the point of production
- shortening the storage time, see Section 4.3.1.4
- drilling with compressed air cooling
- use of applied plastic film lubricants in pressing.

Achieved environmental benefits

Reduction in degreasing processing requirements including chemicals and energy consumption, as well as wastes produced.

Cross-media effects

Consumption of energy and/or materials for alternative techniques, such as dry lubricant films and air-cooled drilling.

Volatile lubricants contain VOC (volatile organic compounds), which are released to the air.

Operational data

Can be considered for all oiled workpieces/substrates.

Applicability

Case dependent. The use and type of oils and greases can be critically and constructively discussed with all customers.

Economics

Case dependent: one installation quotes savings of EUR 25000 per year in oil applied by one of their customers (year 2000 costs), plus uncosted savings in degreasing chemicals and energy, labour and impacts on process quality.

Driving force for implementation

Subsequent process control improved; reworking reduced.

Example plants

Exhall Plating, Coventry, UK.

Reference literature

[18, Tempany, 2002]; [104, UBA, 2003],[3, CETS, 2002]. [113, Austria, 2003].

4.3.3 Jigging

Description

See Section 2.2. The correct jigging, whether using jigs with spring clips to retain the workpieces, or wiring on with copper wire is important for several reasons:

- correct current/area loading in the electrolytic process
- minimising of drag-out, see Section 4.6.3
- prevention of loss of workpieces:
 - the dissolving substrates contaminates the process solution
 - reflects badly on customer quality.

Achieved environmental benefits

Optimises metal usage.

Minimises material losses.

Reduces solution maintenance requirements.

Cross-media effects

None.

Operational data

Requires skilled labour.

Can be labour intensive.

Applicability

All jig plants.

Driving force for implementation

Process quality.

4.3.4 Agitation of process solutions

Description

It is good practice for process solutions to be agitated to keep a consistent solution concentration throughout the vat. This replaces depleted solution at the surfaces and prevents the build-up of gas bubbles and contaminants at the workpiece or substrate surface, giving uneven finishes, pitting, etc. In barrel treatments, sufficient agitation is usually achieved by the turning of the barrels and movement of the workpieces within.

Agitation of anodising solutions is essential to maintain a constant temperature in the bath and remove heat from the surface of the aluminium.

The options are:

- compressed air through nozzles
- low pressure air
- hydraulic turbulence
- agitation of the workpieces by moving the flight bars or rods by cams or motors.

The use of compressed air gives high evaporative heat losses, especially when used in conjunction with air extraction, see Section 4.4.3, as well as energy consumption by the compressor. However, the energy losses may be negligible when used in very small tanks.

Hydraulic turbulence is by a pumped system with eductor nozzles placed at the bottom of the tank. Although the energy required is greater than that needed for traditional air or cathode rod agitation, the energy loss through evaporation of water in air agitated tanks offsets the higher energy usage of hydraulic turbulence.

Achieved environmental benefits

The energy consumption when using air agitated systems is considerable, see Section 4.4.3.

Cross-media effect

Air agitation may create or exacerbate sprays, mists or fumes of airborne particles or droplets. These may contain chemicals harmful in the workplace and/or in the environment, if removed by extraction systems.

Compressors for air agitation may be a source of noise.

Air agitation can be the source of large energy losses, see Section 4.4.3

Operational data

Hydraulic turbulence provides greater agitation than air systems. This results in improved plating quality, reduction of rejects, and optimisation of proprietary additives consumption.

All systems need to be operated at a level that is effective in moving the solution, but does not cause displacement of workpieces from jigs. Displaced parts left in the solution often cause contamination problems (see Section 4.11).

Applicability

All process tanks requiring agitation.

Driving force for implementation

Costs saved in energy consumption, improved process quality, improved workplace health and safety.

Example plants

Bodycote, Uxbridge, UK (formally West Middlesex Plating)

Reference literature

[3, CETS, 2002], [18, Tempany, 2002] [118, ESTAL, 2003].

4.3.5 Maintenance – plant and equipment

Maintenance of all plant and equipment is an essential part of an EMS, see Section 4.1.1 (c)viii.

4.4 Utility inputs and their management

This section discusses the general usage of utilities and individual measures are described by their specific activities, for example the optimisation of energy in air extraction systems is discussed in air emissions, Section 4.18.2 and water-saving measures for rinsing in Section 4.7. In this section, energy inputs are discussed separately as electricity and heating. The reduction of heating losses are discussed as a part of the heating section. Cooling is also discussed as it uses water and/or energy. Water inputs are also considered.

Energy saving measures and systems involve the use of operating tools or equipment capable of:

- maximising the use of energy consumed by the installation, e.g. management of incoming electrical supply
- minimising the energy used to heat process solutions
- minimising the energy (current) losses in electrochemical processes
- minimising the energy used to cool process solutions
- maximising the efficiency of other uses, such as air extraction and other electric drive motors, and the operation of peripheral and recycling plants
- optimising air extraction and space heating.

All utility inputs can be recorded on an actual basis, and split according to type and major end-use on a specified basis, such as monthly, daily, hourly, etc. Inputs can also be benchmarked and optimised against other production measures (see Section 4.1.3), such as surface area or tonnage throughput, number of barrels, processing costs, etc. Action can be taken as described in these Sections where there are variations from the benchmarks.

4.4.1 Electricity

4.4.1.1 Incoming high voltage supplies and large current demands

Description

Incoming supply should be managed to match phases, minimise reactive energy losses on step down from high voltage and supply large current demand, etc.

On a large site, the energy is supplied at 150 kV and is rectified to 0.033 kV for use in the galvanic cells. Typical rectifying operations involve the following steps:

- step 1: two high tension transformers drop the voltage from 150 kV to 15 kV
- step 2: 15 feeding cells drop the voltage for the rectifiers from 15 kV to 525 V
- step 3: 60 rectifiers (one per anode, four per galvanic cell) drop the voltage from 525 V to 33 V. Rectification is through thyristor bridges, transformers and diode bridges
- step 4: supply to 15 galvanic cells. The length of the copper bus bars are short and water cooled to minimise the resistance losses. This is achieved through:
 - a very short distance between the rectifiers and the conductor rolls and anodes
 - the connection of the conductor rolls and anodes through one (the same) side of the cells
 - the individual anode feeding allows an optimal current setting
- step 5: compensation for the reactive energy.

Any AC electrical equipment such as transformers, motors etc., absorbs a total energy called the apparent energy. This is made up of active energy (in the form of work or heat) and reactive energy which is unproductive. The reactive energy increases if the current is out of phase in relation to the voltage, and is the difference between the voltage and the current wave peaks. The power factor ($\cos \phi$) of an electrical device is the ratio of the active power P (kW) over the apparent power S (kVA) and is the cosine of the angle between the peaks of the sine curves of voltage and current. The closer $\cos \phi$ is to unity (1), the more efficient the use of power; the lower $\cos \phi$ value, the less effectively the energy is used. When $\cos \phi$ lies permanently above 0.95, the reactive energy losses at 15 kV and 150 kV levels are limited.

Achieved environmental benefits

Minimises energy losses.

Cross-media effects

None

Applicability

All installations using a three-phase supply. Power correction and reduction of reactive energy requires skilled review of power demands and correction.

All installations using electrolytic processes can ensure reduction of resistance losses in power supplies.

Economics

Energy losses as unwanted heating, reactive energy, etc. increase power consumption and cause higher costs.

Driving force for implementation

Cost saving.

Example plants

Sikel N.V., Genk, NL.

Reference literature

[19, Eurofer, 2003], (Personal communication, Fernando Dorado Nevas, Escuela Superior de Ingenieros, University of Sevilla).

4.4.1.2 DC supply**Description**

Energy savings can be attained through:

- reduction of voltage drop in conductors and connectors
- regular maintenance of rectifiers and contacts (bus bars) in the electrical supply system
- installation of modern rectifiers having a better conversion factor than older types, when run at maximum power
- increasing conductivity of process solutions through additives, e. g. sulphuric acid in acid copper baths, and by maintenance of solutions, such as lowering the iron and the trivalent chromium content in hard chromium baths
- modified wave forms (e.g. pulse, reverse) which may improve metal deposits. This is widely used in PCB plating and is described in Section 6.2.

Achieved environmental benefits

In total, an energy saving in DC supply of 10 – 20 % may be expected.

Cross-media effects

Higher concentrations in solutions means higher drag-out of materials.

Economics

Lower power consumption and therefore lower costs.

Driving force for implementation

Cost savings associated with saving 10 – 20 % of DC supply.

Reference literature

[3, CETS, 2002, 159, TWG, 2004]

4.4.1.3 Energy efficient equipment

Description

It is good practice to install energy efficient equipment, such as energy efficient motors, see Section 4.14.3.1.

Achieved environmental benefits

Power saving.

Cross-media effects

None

Applicability

Depending on the size of the unit and energy consumption, the use of energy efficient motors is good practice for large applications. They can be specified for new installations, for the replacement for defective motors or for cost savings.

Economics

For large scale applications, see Section 4.14.3.1.

Driving force for implementation

Cost saving.

Reference literature

[19, Eurofer, 2003]

4.4.1.4 Optimising process electrical efficiency

Description

Addition of conducting chemical compounds to the electrolyte to increase the electrical conductivity.

Achieved environmental benefits

Reduces electrical power consumption. Environmental benefit is high compared with cost.

Cross-media effects

None

Applicability

To new and existing lines

This requires technical support, either in-house or from the supplier.

Economics

For coil plating, the initial investment is EUR 0.001 to 0.15/t installed, with operating and maintenance costs of EUR 0.001 to 0.15/t installed.

Driving force for implementation

Process efficiency and cost.

Example plants

Many continuous electroplating plants

Reference literature

[19, Eurofer, 2003]

4.4.2 Heating of process solutions

Description

There are four main ways of heating process solutions, and they are by indirect heating coils using:

- high pressure hot water
- unpressurised hot water
- thermal fluids - oils
- direct heating of individual tanks by electric (immersion) heaters or burners directly installed at the surface treatment vats. Immersion heaters are often used to supplement indirect systems.

Information from site visits revealed the following information:

- high pressure hot water can be expensive to run and maintain
- unpressurised hot water and thermal fluids may be cheaper to run
- thermal fluid leakage may damage process solutions irrecoverably
- hot water system leakage may dilute process solutions irrecoverably, although solution may be recovered if leakage is corrected before dilution is significant.

Achieved environmental benefits

Cross-media effects

All process solutions may be damaged by leakages from heating coils, either by contamination of non-aqueous thermal fluids (oils) or by dilution from water leaks.

Where immersion heaters or direct heating are used, it is advisable to monitor the level of liquid in the tank. Heating a tank in this way as been known to dry the tank out and cause fire.

Operational data

High pressure hot water systems require specialist maintenance.

Other systems require monitoring of process solutions to ensure no leaks are occurring into the solutions.

Economics

One installation claimed a payback period of 11 weeks for a EUR 96000 investment when switching from high pressure hot water to a thermal fluid boiler. This figure is based on savings following a period of exceptionally high expenditure for maintenance of the high pressure system before the change over.

Driving force for implementation

Cost savings.

Example plants

Exhall Plating Ltd, Coventry, UK.

Reference literature

[18, Tempany, 2002] [125, Ireland, 2003, 128, Portugal, 2003].

4.4.3 Reducing heating losses from process solutions

It is normal practice to minimise heating losses from process solutions but actual techniques used may depend on the options to re-use heat, the availability of renewable energy supplies and local climatic conditions.

This section briefly describes heating losses in the surface treatment industries. More information on cooling is available in the BREF on industrial cooling systems.

Description

Temperatures of heated processes can be monitored manually or automatically (according to the size and energy demand of the vat being heated), with automatic and/or lockable controls. Record and benchmark information and optimise heating according to Section 4.1.3.

Energy losses from the surface area of heated process solutions related to processing temperatures are shown in Table 3.1. It demonstrates that the highest energy loss occurs from the solution surface with air extraction and with liquid agitation. Air extraction above the surface of process solutions enhances evaporation and thus the energy loss, see Section 4.3.4. Techniques to reduce the volume of warm air extracted and reduce energy losses by evaporation are described in Section 4.18.3.

Where there is a temperature range for a process, the temperature can be controlled to minimise the energy input:

- operating temperature of process solutions that require heating may be reduced,
- processes that require cooling may be operated at higher temperatures.

Heated process tanks can be insulated to reduce heating losses by:

- using double skinned tanks
- using pre-insulated tanks
- applying insulation.

Floating spheres are widely used to insulate the solution surface without restricting the access of workpieces or substrates. They allow jigs, barrels, coils or individual components to pass between them.

Process solutions may be heated by energy coming from process steps generating energy. Water from the cooling circuit of various process solutions may be used to heat lower temperature solutions, incoming air, etc. Alternatively, the hot cooling water is collected in a central tank and cooled through a suitable heat pump. The gain in energy may be used to heat process solutions with process temperatures up to 65 °C, or to heat up water for other purposes.

Achieved environmental benefits

Energy saving.

Cross-media effects

None

Operational data

See Description, above.

Seek technical support when changing operating temperatures changes to processes.

Applicability

To all heated solutions.

Reducing the operating temperature of solutions will depend on support from the proprietary process suppliers or in-house expertise in developing solutions or processes that are viable at lower or higher temperature ranges. It may also be a factor in choice of process solution chemistry (see Section 4.9).

Many solutions have a narrow operating range, and cannot be operated outside of these. Other optimal operating factors may have to be considered, such as processing time.

In anodising, the heat of spent seal solutions can be used to heat the water used for a new sealing process, using a heat exchanger or piping the incoming cold water through the hot seal solution.

In automatic lines, floating spheres may be carried to the rinsing tanks by barrels or by components. The spheres may block pipes and cause malfunctions for pumps and transport tubes. This can be limited to some extent by the choice of size of spheres and installing simple coarse screens to critical pipework and equipment. The spheres can cause tidiness problems in the workplace by being carried outside of the tanks. The system can be used in manual lines, and in automatic plants.

Economics

Applicable to all heated solutions.

Floating spheres are cheap.

Capital investment for sophisticated heat-exchange systems may be high.

Driving force for implementation

Cost saving and process quality control.

Example plants

Exhall Plating Ltd, Coventry, UK; SGI, Plaisir, France, Sikel N.V., Genk, Belgium

Reference literature

[3, CETS, 2002, 18, Tempany, 2002, 165, Tempany, 2004] [85, EIPPCB,] [124, Germany, 2003] [118, ESTAL, 2003] [129, Spain, 2003].

4.4.4 Cooling of process solutions

4.4.4.1 Water cooling systems

Description

Once-through cooling systems pass cold water through the cooling system once, and then discharge the water. Water sources are described in Section 4.4.5.1. Open cooling systems recycle the water through an open cooling tower. Closed systems use a secondary system, such as refrigeration, for cooling the recirculating coolant in the primary system. These are described in Section 2.12.1.3 and more information is given in the BREF on industrial cooling systems

Water from once-through cooling systems may be re-used to utilise the heat gained, for instance in rinsing prior to drying. The water may also be used in processes, with treatment as required, see Section 4.4.5.1. Also, water used in the processes for rinsing may be used for cooling prior to discharge.

Achieved environmental benefits

Using closed cooling systems saves water.

Cross-media effects

There may be energy associated with pumping the water in any system, and increased energy consumption for refrigerated systems.

Once-through systems may deplete limited local resources, may become contaminated by chemicals and the heat content may have an impact on local ecosystems.

Open cooling systems can be the source of legionella infections. Proper design, cleaning maintenance and water treatment combined can generally minimise legionella counts but cannot be expected to eliminate them entirely in every system. Therefore, the location and design of cooling systems must also aim at minimising the distribution and transmission of legionella.

Operational data

It is not good practice to use:

- discharge cooling water through waste water treatment plant, unless treatment is necessary (such as to remove anti-corrosion additives)
- use cooling water to dilute process waste waters.

Applicability

Closed recirculatory systems are widely used. The type of cooling system may be dependent on water availability and local climatic conditions.

Where water resources locally allow, once-through systems may be used, particularly where the water can be returned to the source.

Economics

Once-through water systems are only likely to be economic where the cost of the incoming water is very low, including any charges or taxes for extraction, etc. However, they may be cost-effective where the water is re-cycled or re-used elsewhere in the installation, see Section 4.4.5.1. Water used in the processes for rinsing may be used for cooling prior to discharge, although for most situations and if other water saving techniques are in use, there is insufficient water from such sources to provide sufficient cooling.

Driving force for implementation

Closed systems can offer cost savings in water usage for once-through systems and the cost of maintenance of open cooling systems.

Example plants

Sikel N.V., Genk, Belgium, Exhall Plating, Coventry, UK, Industria Galvanica Dalla Torre Ermanno e Figli SpA, Fontane di Villorba, Italy (re-use of heated water).

Reference literature

[18, Tempany, 2002, 85, EIPPCB, , 159, TWG, 2004] [121, France, 2003] [159, TWG, 2004](personal communication, RIZA and Infomil NL).

4.4.4.2 Evaporation

Description

Evaporation is widely used to remove excessive energy from vats by evaporating water from the process solution and maintaining the process temperature at the desired level. It can be optimised by using an air agitation (see Section 4.3.4), an evaporation system or evaporator, and may be used with cascade rinsing systems to conserve materials, minimise discharges, and can assist with closing loops for materials (see Sections 2.7.4, 2.7.5, 4.7.11.2, 4.7.11.3 and 4.16.12).

Achieved environmental benefits

Evaporation combines process cooling with drag-out recovery and usually forms part of any closed loop or zero discharge systems.

Cross-media effects

May require higher process bath temperatures with increased energy use and/or for drag-out recovery.

May require energy input into the evaporator to evaporate sufficient water.

Condensed water may be re-used.

Operational data

Normally run as an integrated system with countercurrent rinsing to maximise drag-out recovery and minimise process solution losses and therefore waste treatment. With sufficient countercurrent rinsing stages and/or additional heating in the evaporator, loops can be closed for certain materials.

For electrolytic processes, evaporators have less power input and costs are lower if the processing temperature is as high as necessary to remove any electrolytic energy input by natural evaporation from the solution surface (see Annexes 8.5 and 8.11).

Applicability

Can be used with solutions running at ambient temperatures.

Economics

Each kWh removed by evaporation is equivalent to 1.4 litres of water which can be balanced by drag-out recovery containing process chemicals and reduced rinse-water. See Annex 8.11 and for example calculations and sites for cost savings.

Driving force for implementation

If direct evaporation is used, then no capital investment is required. See Section 4.7.11 for driving for solution recovery and minimum discharge processes.

Example plants

Merry Polishing and Plating, Wednesbury, West Midlands, UK, Frost Electroplating Birmingham, UK, most plants in Annex 8.5 use evaporation but plants K and L (Annexes 8.5.8 and 8.5.9) specifically use evaporators.

Reference literature

[3, CETS, 2002, 18, Tempany, 2002, 26, Envirowise, 2003] [104, UBA, 2003]

4.4.5 Water

4.4.5.1 Water supply, treatment and recycling/re-use

Description

Water is commonly from the municipal supply, although it may also come from boreholes or surface waters such as rivers or lakes, depending on local resources and regulations. The types of processes and customer specifications will require a minimum quality of water used.

Water may also be re-used from cooling, rinsing or after waste water treatment, see Section 4.7.8.

It is important when considering the re-use/recycling of water to have an overall approach for the installation that considers the saving of water and raw materials, as well as waste water treatment, see Section 4.7 (particularly Sections 4.7.8, 4.7.11, 4.7.12 and 4.7.13) and Section 4.16. Options may include combining compatible streams from different processes for purification/recovery. This could include use of single fixed location recovery systems (e.g., centralized reverse osmosis/ion exchange for recycling rinse-waters from several process lines). Combined strategies may be more cost-effective, due to economy of scale, unless there are substantially increased plant interface requirements. Point source systems may offer more flexibility, redundancy, and reliability.

For basic uses such as cooling and floor and plant cleaning, only the suspended and/or (TDS) content may be of importance and recycled water may be adequate; but depending on the source, filtering may be required. For many process solutions and rinses, water similar in quality to drinking water is satisfactory, again possibly with filtering. For high quality work or to improve process and product quality water sources will require treatment to lower TDS to demineralised or deionised water quality:

- where the staining from TDS left from drying is critical, such as decorative finishes or printed circuit boards, or
- where there is interference in the process, such as anodising annealing.

Where incoming water is treated to reduce TDS, it may be more effective to treat and recycle the waste rinse-waters, as the amount of dissolved salts added during the process rinsing may be less than the amount in the incoming water.

Treatment options include (see Section 2.7):

- filtration
- deionisation/demineralisation
- ultrafiltration
- reverse osmosis.

The residues of these treatments will contain the retained solids and any saline solutions from regeneration (deionisation/demineralisation). They may be discharged to the treatment plant of the installation or directly to foul sewers, according to local environmental considerations.

Achieved environmental benefits

Water saving, where water is recycling or re-use.

Cross-media effects

Increased dissolved salts in waste waters from treatments such as reverse osmosis, deionisation, Use of chemicals in deionisation.

Example plants

See German plants in Annex 8.5; BGT, Eindhoven, NL.

Reference literature

[166, RIZA, 2004]

4.4.5.2 Control of water usage

Description

Recording all water inputs on an actual basis, irrespective of the source costs enables usage control (including internally treated supplies, see Section 4.4.5.1). This is achieved by metering all usage points throughout the installation: on rinses, solution top-up, even in areas such as washrooms, etc. This identifies areas of high water usage for appropriate corrective action.



Figure 4.3: Example of locking flow valve
Menoni SA, France and Agence de l'eau Seine-Normandie

The usage can be monitored according to type and major end-use on a specified basis, such as monthly, daily, hourly, etc. Inputs can also be benchmarked and optimised against other production measures (see Section 4.1.3.1) such as surface area or tonnage throughput, number of barrels, processing costs, etc. Where consumption is seen to be higher than external and/or internal benchmarks, action can be taken in the areas to examine the cause(s).

When optimum water usage is established, flow can be maintained at an optimum usage rate level by a variety of measures controlled by an authorised person, such as:

- flow valves - it is good practice to use locking valves
- conductivity, pH temperature or other process control measurements - this may be automated, and can also be used to control static fill and dump systems, either manually or automatically (see Section 4.7).

Achieved environmental benefits

Water consumption in one case has been reduced over seven years by 83 %, from 263636 m³ to 31818 m³ per year by installing about 70 water meters (usually 20 – 30 mm). Other installations confirm significant savings can be made.

Cross-media effects

None reported.

Operational data

Maximum effect is gained when used in conjunction with locking flow valves set at optimum usage rate and with other monitoring data, such as water usage per flight bar or per square metre treated.

Applicability

To all installations.

Economics

Installations with direct raw water abstractions from resources that are fully and continually replenished may not have a financial payback for the investment. Note that reduced water consumption also means reduced water volume discharged, and this may reflect in lower cost for discharge to municipal or third party water treatment plants.

Driving force for implementation

Rapid payback period where water costs are significant.

Example plants

Exhall Plating Ltd., Coventry, UK; Frost Electroplating Ltd., Birmingham, UK.

Reference literature

[18, Tempany, 2002]

4.4.5.3 Rinsing stages using recycled water

Description

The technique may be regarded as an extension of the integrated treatment system (widely known as the Lancy system). Water from a rinsing stage is re-used in another rinsing stage, where the chemical or physical characteristics acquired in the first stage can be exploited in the second stage without requiring any additional treatment.

As an example, in a nickel electroplating installation water from the rinsing stage after the nickel plating process may be used again in a sequence of several rinsing stages:

- 1st: after cool electrolytic degreasing, then
- 2nd: after pickling, and eventually
- 3rd: after heated chemical pre-degreasing

Achieved environmental benefits

Reduction of water consumption up to 40 %.

Reduction of chemicals used to modify the pH of water after the rinsing stages.

Reduction of chemicals used to neutralise the water before to channel it into the treatment plant.

Operational data

The technique applies only to processes free of cyanides. It requires the laying of an appropriate network of pipes and pumps.

Applicability

The technique may apply to new plants. It can be applied to existing plants, depending on local circumstances.

Economics

No data available

Driving forces for implementation

Saving of water and chemicals.

Example plants

Coletto Danilo Srl, Padova, Italy. Industria Galvanica Dalla Torre Ermanno e Figli SpA, Fontane di Villorba, Italy.

Reference literature

Lancy Laboratories Inc., Zelienople, Pa (US) quoted in Bertorelle E. (1974) – Trattato di Galvanotecnica. 4th Edition, Vol. II, Hoepli Ed. Milano, pp. 693 - 697.

4.5 Drag-in reduction

Description

Drag-in can contaminate a process solution if there is insufficient rinsing after the previous processes. Drag-in of clean rinse-water can significantly dilute a process solution. Drag in can be minimised by using an eco-rinse (or pre-dip), see Section 4.7.4, or by removing as much rinse-water as possible, such as by air knives or wiper rollers for sheet or coil substrates. The effects can also be minimised by using compatible chemical systems, see Section 4.6.2

Achieved environmental benefits

Extends the life of process solutions.

Cross-media effects

Spray from using air knives or blowers.

Operational data

See Description and Section 4.7.4.

Applicability

Eco-rinse cannot be used in all situations, see Section 4.7.4.

Economics

See Overall economics, Section 4.7.1

Driving force for implementation

Extending process solution life, improving process quality and reducing material costs in make up chemicals.

Reference literature

[159, TWG, 2004, 165, Tempany, 2004]

4.6 Drag-out reduction

4.6.1 Preliminary remarks

Drag-out is described in Section 2.4.

A reduction of drag-out is an effective primary measure for:

- minimising losses of chemicals in rinses
- reducing the amount of rinsing required
- reducing raw material costs
- reducing quality and maintenance problems with subsequent processes
- reducing environmental problems associated with rinsing waters.

Techniques to reduce losses of chemicals resulting from drag-out are outlined in this section. These are also applicable to other process specific sections e.g. coil coating, PCBs, etc.

However, elimination of drag-out is impossible.

Drag-out depends on a large variety of parameters and a reduction of this key step with many impacts on the environment and the process can only be achieved by close co-operation of all personnel involved. For this reason a thorough understanding of the complex interrelations of many parameters is needed by the operational staff to improve the situation successfully, see issues such as training in environmental management systems, Section 4.1.1

4.6.2 Use of compatible chemicals

Description

The use of compatible chemicals (e.g. the use of the same acid in pickling or activating the surface prior to an acid-based plating process) reduces the consequences of chemical drag-over to the subsequent process.

Achieved environmental benefits

Minimises loss of chemicals as they are used in the next process.

Minimises water use in intermediate rinsing.

Cross-media effects

May increase the need to top-up the chemicals in the first stage that would otherwise be recovered from counter-flow rinsing, etc. (see Section 4.7).

Operational data

May increase maintenance requirements on the subsequent solution, e.g. removal of dissolved contaminating metals.

Reduces the number of stages required in a process line by removing/reducing rinse steps.

Applicability

Applicable to all types of processing, but limited to where processes having compatible chemistry can be used.

Economics

Low cost, depending on choice of chemical systems.

Driving force for implementation

Cost savings.

Reference literature

[CETS, 2002 #3; [104, UBA, 2003].

4.6.3 Reduction of drag-out – jig (rack) processing

Description

Arrange the largest surfaces of the workpieces in a vertical position at the jigs (racks) allows the adhering solution to run down to the bottom edge of the workpieces,

The longer dimensions of the articles are normally arranged horizontally and/or slightly inclined to allow the adhering solution to run down, improving drainage.

The lower edge of all articles may be tilted to allow the droplets to cohere and facilitate dripping down above the process tank.

When lifted out of the process solution, the jigs may be tilted in such a way that large droplets can be formed faster and drip down from the lowest point of the suspended articles.

Allow sufficient drainage time above the process tank to let the adhering liquid to cohere and form droplets which will drip from the articles

By slow withdrawal of the jigs from the process solution, the drag-out volume can be decreased considerably. Therefore, slow withdrawal and a sufficient drainage time above the process tank can significantly minimise drag-out. Withdrawal and dwell times given in Table 4.2 below are valid for some specific processes and are given as indication only. The times vary according to the specific processes.

Process	Minimum time withdrawal (seconds)	Minimum time dwell (seconds)
Plating	10	10
Cleaning/pickling	8	7
Passivation	10	10
Seals/lacquers	10	5

Table 4.2: Withdrawal and dwell times for jigs

Cup-shaped recesses are normally avoided where possible, and cup-shaped components are jigged cup-side down on the incline so process solution is not carried into the rinse-water.

In some cases, arrangements can be made by dialogue with customers for components with high drag-out retention, such as cup-shaped components, to be manufactured with drainage holes.

Dripping of process solution on other articles arranged lower on the jig is normally addressed by suitable positioning of the workpieces.

Automatically or manually inserted draining pans below the jigs will collect any drippings and prevent contamination of subsequent tanks and solutions (where immediately adjacent vats are not used). A fast transfer of the racks from one tank to the next also minimises this.

Drag-out by jigs can be reduced by inclining supporting arms to avoid horizontal surfaces from which the adherent solution cannot easily run off.

A normal inspection and maintenance task is to check the insulation coating of the jigs to ensure smooth surfaces, with no fissures or cracks in damaged insulation to trap and retain solution. It is good practice to regularly inspect jigs for defective insulation so they can be identified for replacement or repair.

Jig insulation coatings are normally hydrophobic to assist draining of drag-out.

Jigs may be rinsed or sprayed with water, or blown with air to remove dragged-out solution (see Section 4.6.6).

Achieved environmental benefits

This is a key step in reducing the loss of soluble chemicals from process vats to the environment via rinsing.

Cross-media effects

None reported.

Operational data

Where a rapid stopping of the surface reaction is required, this is often achieved by rapid dilution of the remaining process solution on the surface, particularly for:

- hexavalent chromium passivation
- etching, brightening and sealing of aluminium, magnesium and their alloys
- zincate dipping
- pickling
- pre-dip when activating plastic
- activating prior to chromium plating
- colour lightening after alkali zinc.

In some processes drainage time may affect the quality of the treated surface, such as where a delay causes de-activation of, or damage to, the surface between treatments, such as between nickel plating followed by chromium plating.

For problems with blowing or spraying, see Section 4.6.6.

The dragged-out volume is:

$$W = 0.02A \cdot \sqrt{\frac{a \cdot p}{t \cdot d}}$$

where:

W is the volume withdrawn in cm³

A is the surface area of the article in cm²

a is the vertical length of the article in cm

p is the dynamic viscosity of the process solution in Poise (1 Poise = 0.1 Pascal second)

t is the withdrawal time in seconds

d is the density of the process solution.

The surface roughness of the articles was found to have no effect on the volume of drag-out.

Actual drag-out measurements can be determined by chemical or measuring the increase in volume. In the absence of such data, the following typical data can be used for rack plating:

- flat surfaces 0.1 l/m²
- contoured surfaces 0.2 l/m²
- the equation above is for flatter shapes. A typical value for cup shapes is 1 l/m².

Applicability

All jig (rack) plants.

Economics

All these measures can be incorporated into the operation of any jig (rack) plant. Jigs have a relatively short operating life, are not capital intensive, and design can be improved and implemented over time. Correct positioning of workpieces on jigs is usually achieved by staff training.

Other measures, such as draining and dwell time will depend on transporter control equipment being used.

Increasing time for draining can reduce throughput and machine capacity.

Driving force for implementation

Cost savings in chemical usage and reduction in waste water treatment costs.

Reference literature

K. G. Soderberg (Proceedings of the American Electroplaters' Society 24 (1936) pp. 233 - 249), [3, CETS, 2002] [118, ESTAL, 2003](personal communications, TWG members) [113, Austria, 2003]. [104, UBA, 2003]

4.6.4 Reduction of drag-out barrel processing

Description

The plastic material of the barrel normally has a smooth surface and is inspected for worn areas and the formation of recesses or bulges around the holes.

The bores of holes in the panels usually have a sufficient cross-section to minimise capillary effects, and the thickness of the panels of the cylinder is just thick enough to meet the mechanical strength requirements.

The total proportion of the body of the barrel that is perforated is usually as high as possible to allow the drag-out to drop back easily into the process tank. This also improves the efficiency of the whole plating process by allowing easier solution access and decreasing voltage drop.

A further reduction of drag-out can be attained by intermittent rotation of the barrel above the process tank while draining (such as rotating for about 90 degrees, stopping for at least 10 seconds, next sequence of intermittent rotation, etc.).

More reduction of drag-out can be achieved by the application of draining ledges within the barrels to allow the draining liquid to flow together and to drain out of the rotating barrel.

Drag-out can be reduced dramatically by blowing excess solution out of the barrel while draining over the bath. With hot baths, the barrels can be rinsed with water or sprayed (see Section 4.6.6), although for barrels, sparging is more effective: sparging is where pipe is constructed within the barrel and runs rinse-water inside the barrels and through the workpieces.

In a barrel, the workpieces usually lie with the main surfaces horizontal. To achieve better draining, inclined lifting of the barrels from the tanks can be considered. The suspension and hoisting systems may be adapted to this requirement. However, in conventional systems this is difficult to achieve.

The application of mesh plugs instead of holes has proven successful, by reducing the length of the bores in the panels of the cylinder body of the barrel. The drag-out can be decreased, and the voltage drop at the perforation is effectively reduced.

Achieved environmental benefits

This is a key step in reducing loss of soluble chemicals from process vats to the environment via rinsing.

Cross-media effects

When blowing out the barrel with air or water spray, care must be taken to ensure that the removed solutions fall into the bath below, and to minimise droplets or particles in the air. Removed solutions could be harmful in the workplace atmosphere, in the outside environment and may contaminate other processes (see Section 4.6.6).

Operational data

As with jig plating, where a rapid stopping of the surface reaction is required, this is often achieved by rapid dilution of the remaining process solution on the surface. In some processes excessive drainage time may affect the quality of the treated surface, see Sections 2.5 and 4.6.3.

To minimise the volume of liquid dragged out, the barrel may be withdrawn from the liquid slowly to decrease the drag-out effectively, with a sufficient draining time afterwards as described in Table 4.3.

Process	Holes (mm)	Minimum time		
		Withdrawal (seconds)	Dwell (seconds)	Stationary periods (see Note*)
Plating	2	5	24	3 x 6
	3	5	20	3 x 6
	4	5	16	2 x 6
	>6	5	12	2 x 6
Cleaning/pickling	2	5	24	3 x 6
	3	5	20	3 x 6
	4	5	16	2 x 6
	>6	5	12	2 x 6
Passivation	2	5	16	1 x 6
	3	5	12	1 x 6
	4	5	8	1 x 6
	>6	5	4	1 x 6
Seals	2	5	24	3 x 6
	3	5	20	3 x 6
	4	5	16	2 x 6
	>6	5	12	2 x 6

Note*: barrel is rotated one, two or three times through 90° with a 6 second dwell period.

**Table 4.3: Withdrawal and dwell times for barrels
CETS Italy, Assogalvanica**

Actual drag-out measurements can be determined by measuring the increase in chemical concentration in the first rinse or measuring the increase in volume.

Data for zinc barrel plating is given in Table 4.4 and Table 4.5:

	760 mm barrel width	1200 mm barrel width
Flat and contoured surfaces	1 – 2 l/barrel	2 – 3 l/barrel
Cup shapes	2 – 4 l/barrel	3 – 6 l/barrel

Table 4.4: Drag-out retention, barrel diameter 380 mm with 8 mm holes

	760 mm barrel width	1200 mm barrel width
Flat and contoured surfaces	2 – 4 l/barrel	3 – 5 l/barrel
Cup shapes	3 – 6 l/barrel	4 – 8 l/barrel

Table 4.5: Drag-out retention, barrel diameter 380 mm with 2 mm holes

In some processes, such as chromium passivation, excessive drainage time may affect the quality of treated surface, see Section 2.5. Where a rapid stopping of the surface reaction is required this is often achieved by rapid dilution of the remaining process solution on the surface.

Applicability

All barrel process activities.

Economics

Many of these measures can be incorporated into the operation of any barrel plant. Barrels have a limited operating life, require maintenance, are not capital intensive, and design can be improved and implemented gradually.

Other measures, such as draining and dwell time, will depend on the transporter control equipment used.

Increasing time for draining can reduce throughput and machine capacity.

Driving force for implementation

Savings in chemicals and other inputs for degreasing. Reduction in wastes produced.

Example plants

Exhall Plating, Ltd, Coventry, UK.

Collini GmbH, Austria.

Reference literature

[3, CETS, 2002],[113, Austria, 2003], [104, UBA, 2003] [165, Tempany, 2004](personal communication, Martin Peter, GmbH, Collini GmbH)

4.6.5 Properties of process solutions – effect on drag-out

Description

The drag-out also depends on the properties of the process solutions.

Drag-out can be reduced by raising the temperature of the process solution which normally lowers the viscosity of the solution.

Lowering the concentrations of the process solutions will effectively reduce the drag-out, by lowering the amount of material contained in the dragged-out solution, as well as reducing surface tension and viscosity of normal ionic solutions.

The addition of wetting agents to the process solution reduces the drag-out by reducing surface tension.

To avoid excessively increased concentrations, the process solution may be controlled to a constant composition during regeneration and maintenance. This, and the selection of appropriate process solutions, is an important step in the reduction of drag-out.

Achieved environmental benefits

This is a key step in reducing the loss of soluble chemicals from process vats to the environment via rinsing.

Cross-media effects

Increasing the temperature of process solutions uses extra energy.

The addition of wetting agents increases in the amount of chemicals used.

Operational data

Reducing the concentrations of chemicals in solutions below prescribed levels will need technical expertise in-house or from suppliers.

Ensuring constant compositions of process solutions is a part of SPC, see Section 4.8.1

Temperature sensitive brighteners may be affected by increased temperatures.

Applicability

All process solutions.

Driving force for implementation

Improved process control and costs.

Reference literature

[CETS, 2002 #3; UBA, 2003 #104, [124, Germany, 2003]

4.6.6 Transition from drag-out draining to rinsing

Description

There is a close connection between minimising drag-out and the following rinsing steps. In barrel plating, sucking off or blowing off a considerable part of the drag-out above the process tank is a successful measure to reduce losses of process solutions.

A key measure for high drag-out reduction for uniform cross section workpieces or substrate are squeeze or wiper rollers. They are used in coil processing see Section 4.14.5 and for PCB manufacture see Section 4.15.2.

When jigs (racks) or barrels are being removed from a tank of heated solution, it is good practice to drench it with a fog spray while it is still over the processing tank. This achieves a reduction in drag-out loss, and the water used compensates for evaporation. This treatment can be combined with a pre-rinse, returning water from the first static rinse to the process solution. For removing solution adhering to, or trapped in, recesses, combined water and air jets may be used above the process tank and within an empty tank, respectively.

Sloping drain boards of plastic material can be provided at the exit end of each tank. In effect, these extend the draining period for the workpieces and return as much of the drippings as possible to the tank of origin.

Achieved environmental benefits

This is a key step in reducing the loss of soluble chemicals from process vats to the environment via rinsing.

Cross-media effects

Energy usage in compressed air for blowing drag-out off workpieces.

Blowing off or spraying can distribute aerosols of bath solutions within the workplace and via extraction systems to the environment. Other processes can be contaminated.

Operational data

Blowing off or spraying jigs or barrels is difficult practice, and can be technically elaborate

Applicability

To all jig and barrel installations.

Economics

Costs in energy consumption and pumping may be offset by savings in chemicals and waste water treatment

Reference literature

[3, CETS, 2002] [113, Austria, 2003].

4.7 Rinsing techniques and drag-out recovery

4.7.1 Introduction

This section must be considered in conjunction with Section 4.6 above, which highlights the reasons for controlling drag-out and drag-in. This section discusses techniques for two connected purposes [3, CETS, 2002]:

- how drag-out (and drag-in) can be reduced by different means
- how rinsing water consumption can be reduced.

Section 2.4 describes the need for rinsing to reduce cross-contamination and/or deterioration in the appearance of the workpiece by chemical attack or dried-on salts.

Some recommended rinsing ratios are given in Table 4.6:

Process		Ratio
Post alkaline cleaner rinse		2000
Post acid pickle rinse	Pre-cyanide process	5000
	Pre non-cyanide process	2000
Post plating rinse	Cadmium, silver, zinc (alkaline)	2000
	Zinc (acid)	3000
	Electrolytic nickel	5000
	Autocatalytic nickel	10000
Chromium VI	15000	
Post passivate rinse		5000

Table 4.6: Some recommended rinse ratios
[29, EA, 2001-3]

Drag-out of process solution and drag-in of rinse-water leads to continuous dilution and drop of chemical concentration in process solutions. This is shown in Figure 4.4.

Note: The theoretical formulas have been used, as little operational data have been provided. All formulas mentioned in this section provide exact theoretical results which do not concur with practical experience. This is caused by (but not limited to) simple parameters such as varying quantities of drag-out for different workloads, different rinsing efficiencies due to differing shapes of processed components or changing concentrations of wetting agents in process solutions.

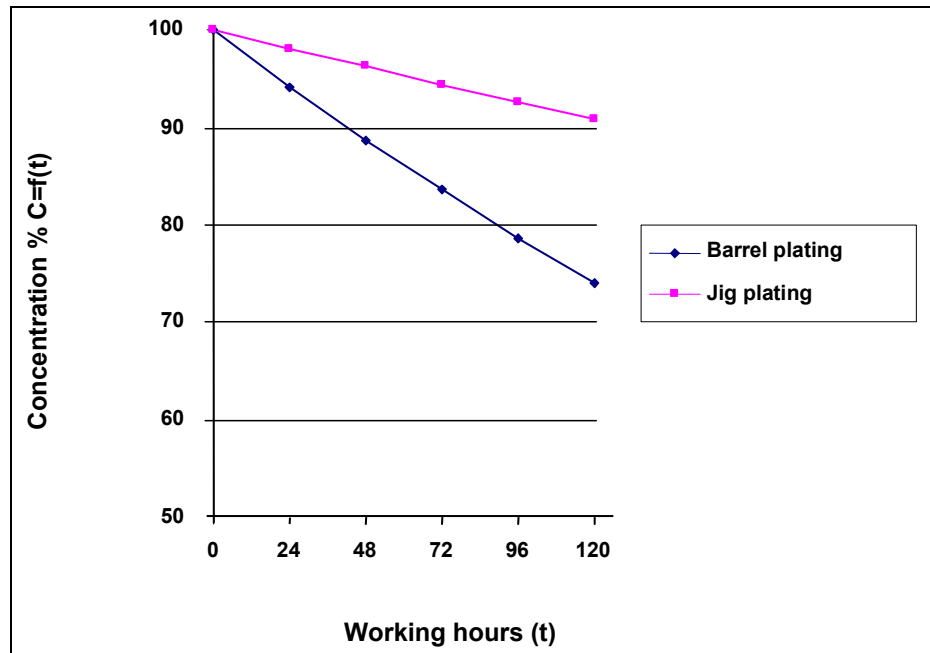

Figure 4.4: Drop of chemical concentration in process solution due to drag-in of rinse-water and drag-out of process solution without replenishing

Note: $C=f(t)$ is concentration of process solution at time (t)

The concentration left in the process solution can be calculated:

$$C_{0n} = C_0 \{V/(V+D)\}^n$$

- C_{0n} = concentration of chemicals in process solution after n work loads
- C_0 = concentration of chemicals in process solution at start of operation
- V = volume of process solution
- D = quantity of drag-in/drag-out per work load (barrel or flight bar)
- n = number of workloads processed.

Reference data for Figure 4.4:

Barrel plating:

- throughput: 10 barrels per hour
- drag-in/-out: 1.5 litres per barrel, 15 litres per hour
- process solution: medium cyanide zinc
- total volume: 6 m³
- processing temperature: ambient.

Jig plating:

- throughput: 15 flight bars per hour (25 m² of surface area to be plated)
- drag-in/-out: 0.4 litres per flight bar, 6 litres per hour
- process solution: bright nickel, air agitated
- total volume: 7.5 m³
- processing temperature: 60 °C.

General cross-media and operational effects

Drag-out can be used as a means for regeneration of process solution, as it continuously removes process-disturbing residues of degradation products from brighteners and other organic additives. This ignores the simultaneous loss of valuable undegraded components. However, the use of drag-out minimisation and recovery techniques are likely to increase the need for properly designed techniques to reduce or remove contaminants *in situ*, see Section 4.11.

Overall economics

The economics for the recovery of materials and the reduction of water usage, vs. the cost of increasing the number of rinse tanks in a rinsing stage, amendments to plant, etc. can be calculated using the data in this section, with specific plant data. It can also be calculated using software tools for plant optimisation, see Section 4.1.4. Annex 8.11 shows examples of rinsing after cleaning, after pickling, after electrocleaning, after plating and in conjunction with forced evaporation, as well as after passivation.

4.7.2 Evaporation as a requirement for drag-out recovery

Evaporation is described in Sections 2.7.4 and 2.7.5. Increased recovery of drag-out is made feasible by using the used rinse-water to equalise the evaporation losses from process solutions. Techniques for using and increasing evaporation are discussed in Sections 4.7.11.2 and 4.7.11.3.

This cannot be achieved for:

- where problems are caused with subsequent processes (such as partial chemical pre-plating)
- carousel, coil coating or reel-to-reel lines because work cannot be returned through the pre-dip tank. A second tank could be installed after and coupled by a pumped system, but this is not known in practice and would require the creation of another tank in the line, which may be impossible with existing plant
- etching or degreasing
- nickel lines because of increased quality problems.

In anodising, material is removed from the substrate (not added) and the technique is not used.

Economics

See Overall economics, Section 4.7.1

An increase in the number of steps causes loss of machine capacity.

Driving force for implementation

Where the process solution is running at ambient temperatures and/or there is little evaporation taking place.

Reference literature

[3, CETTS, 2002] [113, Austria, 2003].

4.7.5 Spray rinsing

Description

Spray rinsing may be carried out in two ways: over the process solution (as in Figure 4.6) or in a separate empty tank.

Spraying prior to rinsing (or pre-rinse) above the process bath is an effective method of rinsing. The rinsing water is sprayed onto the workpieces while they are still above the bath surface. This may be manually for small process lines, or automatically. For the pre-rinse, the amount of water to be used should equal that dragged-out from the process tank to maintain the water balance. The pre-rinse causes a direct feedback of process solution into the process tank.

Spray rinsing in a separate tank acts as a first rinse. The solution can then be recycled back to the process solution in amounts equal to evaporative and drag-out losses.



Figure 4.6 Manual spray rinsing
Producmetal S.A., France

Achieved environmental benefits

This is a key step in reducing the loss of soluble chemicals from process vats to the environment via rinsing.

Cross-media effects

There is a risk of legionella bacteria infecting in the pipe ends of spray systems and being spread in the spray aerosols.

Operational data

Spraying above the bath recovers the process solution directly back into the tank. No additional tank is required. However, overspray may cause problems, but can be controlled in various ways, for example:

- in anodising, spraying is used at low pressure, referred to as ‘splash rinsing’, which avoids the creation of aerosols and over-spraying
- spraying in a tank reduces over-spray.

Legionella infection can be prevented by design of the spray systems or regularly cleaning. Testing may be required.

Applicability

Can be considered for all installations, but may be limited where there is a risk of drying and residues being left on workpieces or substrate prior to further rinsing or processing.

Example plants

SGI, Plaisir, France.

See reference plants in Annex 8.5.

Reference literature

[104, UBA, 2003] (Personal communication from ESTAL)

4.7.6 Manual or semi-automatic lines

Description

Manual or semi-automatic lines are used for small production throughput, or for development work. Controlling water usage, drag-in and drag-out may appear more difficult. To achieve adequate draining time on a manual line, the jig or barrel should be supported on a static rack over the preceding bath.

This enables spray rinsing (see Section 4.7.5) to be carried out directly above the treatment tank to return the drag-out and/or allows draining to be properly timed before immersion in a rinse.

In semi-automatic lines, spray rinsing can be also carried manually, see Section 4.7.5 and Figure 4.6

Achieved environmental benefits

As for drag-in and drag-out control, see Sections 4.5 and 4.6

Cross-media effects

None

Operational data

Ensures better reliability and repeatability of rinsing and draining for automatic and semi-automatic lines.

The amount of spraying above a treatment process needs to be controlled to avoid exceeding the drag-out and evaporative losses.

Applicability

All manual and semi-automatic lines.

Economics

Cheap and easy to install.

Driving force for implementation

Health and safety of staff using manual lines.

Example plants

Bodycote West Middlesex Plating Co. Ltd., Uxbridge, UK.

Reference literature

[18, Tempany, 2002, 165, Tempany, 2004]

4.7.7 Chemical rinses

Description

An accelerated technique to achieve the required cleaning efficiency is obtained by means of chemical rinses called the Lancy process. Here the dragged-out process solution is reacted chemically with the rinsing liquid at the same time.

Achieved environmental benefits

Reduces the effluent treatment capacity required by reducing or eliminating the primary waste water treatment stages.

Cross-media effects

The main use of the Lancy process, the oxidation of dragged-out cyanides by rinsing in chlorine bleaching caustic solution, is now reduced because of concerns about the associated AOX generation.

The processes make recovery of dragged-out solution impossible.

Operational data

Technically simple to operate.

Incorporation of chemical rinsing can reduce the number of rinse stations with a consequent increase in contaminated rinsing.

Can lead to large sludge build up in the rinsing tanks. There is a danger of gas build up if the automatic dosing fails.

Applicability

Requires a suitable chemical reaction that can readily take place in the conditions of the first drag-out tank. The main uses are:

- oxidation of cyanide
- reduction of hexavalent chromium.

Limited contact time may not eliminate the target chemical, especially cyanide. This limits the usefulness to the reduction of Cr(VI), particularly where workpieces have complex geometry and retain Cr(VI) solution. The usual system is a vat after the chromium bath with sulphuric acid and sodium bisulphite.

Driving force for implementation

Can be used where waste water treatment capacity is limited.

Reference literature

[IHOBE, 1997 #6; UBA, 2003 #104[3, CETS, 2002, 6, IHOBE, 1997] [124, Germany, 2003] Lancy Laboratories Inc., Zelienople, Pa (US)

4.7.8 Regeneration and re-use/recycling of rinsing water

Section 4.4.5.1 highlights how water can be regenerated and re-used, and that this should be considered in the context of the water usage for the whole installation.

Spent rinse-water can be regenerated, such as by one of the techniques described below (for other possibilities, see Section 4.10). This can lead to savings in water consumption and will reduce to amount of waste water to be treated, reducing the waste water treatment costs for capital investment, energy usage and chemicals. However, this has to be offset by the cost of the regeneration equipment and the power and chemicals that this may incur. Where incoming water is treated, it is often easier and cheaper (in terms of capital deployed, chemicals and power) to recover the rinse-water than to treat fresh incoming water, as the ionic concentration or TDS in the incoming water may be higher than that of the rinse-water.

The cross-media effects for one application have been investigated, see Section 4.7.8.2 [159, TWG, 2004, 166, RIZA, 2004].

4.7.8.1 Regeneration by ion exchange**Description**

By feeding the rinsing water through cation and/or anion exchangers, the cations become exchanged for H^+ , and the anions for OH^- , and water of a quality approaching demineralised water is achieved. This is fed back to the rinsing system.

Achieved environmental benefits

Minimised water usage.

Cross-media effects

Construction and operation of the ion exchanger with consumption of energy and regeneration chemicals.

Operational data

A filter is used before the ion exchanger for protection against blocking by solid particles.

Applicability

An ion exchanger to regenerate rinsing water is not usable if strong oxidants, high concentrations of organic material, and metal cyanide complexes are present. To regenerate highly concentrated rinsing waters, large scale installations and frequent regeneration of the system are needed, e.g. with HCl or H_2SO_4 and $NaOH$.

The resins do not usually remove organics, which will accumulate in the rinsing water. This may require additional treatment. If not, in a system with a central ion exchange plant, the organics may be spread to all processes and might interfere with other processes, such as the rinse recovery, unless additional cleaning processes are added, such as activated carbon filtration, or the use of the recycled water is limited to selected uses.

Ion exchange may become impractical for use with total dissolved solids concentrations above 500 ppm, due to the need for frequent regeneration.

Resins have different effective pH ranges. For example, iminodiacetate chelating resin works best in a slightly acidic range; selectivity is lower at higher pH and below a pH of approximately 2.0.

Oxidants, solvents, organics, oil and grease can degrade resins and suspended solids can clog resin columns.

Economics

Capital cost of equipment versus savings in water usage will be site-specific.

Example plants

Richard (Argenteuil), SATEC (Buchelet), SEAM (les Mureaux), France

Reference literature

[104, UBA, 2003], [114, Belgium, 2003, 124, Germany, 2003, 162, USEPA, 2000]

4.7.8.2 Regeneration by reverse osmosis

Description

Rinsing water can, in some cases, be regenerated by reverse osmosis (this process is described in Section 4.7.11.5).

Achieved environmental benefits

The achieved environmental benefits are more than just a reduction in water usage and extend to energy savings and a significant reduction in chemical use in waste water treatment.

Cross-media effects

Construction and operation of the ion exchanger with consumption of energy and regeneration chemicals. The salt content of the residual water is high and may be difficult to treat in a typical waste water treatment plant. The membranes also need rinsing with fresh water.

Applicability

The water to be treated may not be suitable or may need pretreatment because of solids or undissolved particles, organics, calcium, aluminium and heavy metals, see Section 4.7.11.5

Example plants

BGT Eindhoven, Netherlands

Reference literature

[126, Netherlands, 2003].

4.7.9 Single rinsing techniques

Description

In certain situations, single rinsing operations are necessary (see Section 4.6.3). This may be where there is a loss in quality if there is too much rinsing of the surface, for example, black passivation zinc, thick film passivations or rinsing between nickel and bright chromium

In other cases, the stopping of the surface reaction succeeds only when there is quick dilution in the first rinsing stage, which requires the use of high quantities of water. In such cases, the concentration of the reacting chemicals in the first rinsing stage must be kept low.

Other examples are manual or semi-automatic lines with small production throughput, or used for development work, see Section 4.7.6 above.

To minimise environmental impacts:

- water used here may be regenerated and recycled within the process, e.g. by a deioniser, or water regenerated from elsewhere may be used
- where technically possible, having compatible chemistry for the preceding and subsequent solutions can minimise the need for rinsing (e.g. same acid base), see Section 4.6.2.

Achieved environmental benefits

Steps to minimise impacts are described in Description, above.

Cross-media effects

High water consumption and material losses.

Operational data

Multi-stage rinsing may damage surface treatment, such as reducing corrosion resistance.

Applicability

See Description, above.

Reference literature

[3, CETS, 2002, 104, UBA, 2003],[113, Austria, 2003, Germany, 2003 #124]

4.7.10 Multiple rinse techniques

General description

Multiple stage rinsing is particularly suitable to achieve a high rinsing rate with a small amount of rinsing water.

For example, in cascade rinsing, the water flows in the opposite direction to the workpieces, as shown in Figure 4.7. This results in a rinsing water requirement of constant rinsing quality (the rinsing ratio), and is mathematically expressed in the term:

$$Q/t = \sqrt[n]{Sk} (V/t)$$

Q/t	= rinsing water amount (in l/h) required to reach the rinsing ratio
n	= rinsing stage number
Sk	= rinsing ratio
V/t	= drag-out (in l/h)

The main effect of saving is reached with the transition from the first into the second stage. As Table 4.7 shows, a smaller rinsing quantity of water can be achieved by the selection of the correct rinsing system. The effect of water saving decreases with an increasing number of rinsing stages. However, the volume of water required decreases to the point where direct make up for water losses from process solutions at ambient temperatures can be considered. The achievable recovery rate is, at a given volume of evaporation, directly related to the concentration of process chemicals in the first rinse station.

Rinsing ratio(x:1)	10000	5000	1000	200
Number of stages	Necessary rinsing quantity of water in l/h			
Single stage	10000	5000	1000	200
Two stages	100	71	32	14
Three stages	22	17	10	6
Four stages	10	8	6	4
Five stages	6	5	4	3

Table 4.7: The rinsing ratio is a function of a specific rinsing quantity of water (expressed as litres of rinsing water per litre of dragged-out electrolyte) given and the number of cascades [3, CETS, 2002].

Some options and variations are outlined in Sections 4.7.10.1, 4.7.10.2, 4.7.10.3 and 4.7.10.4. They may be used in conjunction with other techniques, such as those described in Sections 4.7.1, 4.7.4, 4.7.5, 4.7.7, and 4.7.8.

Only a description of each option is given, other factors are described in this general section.

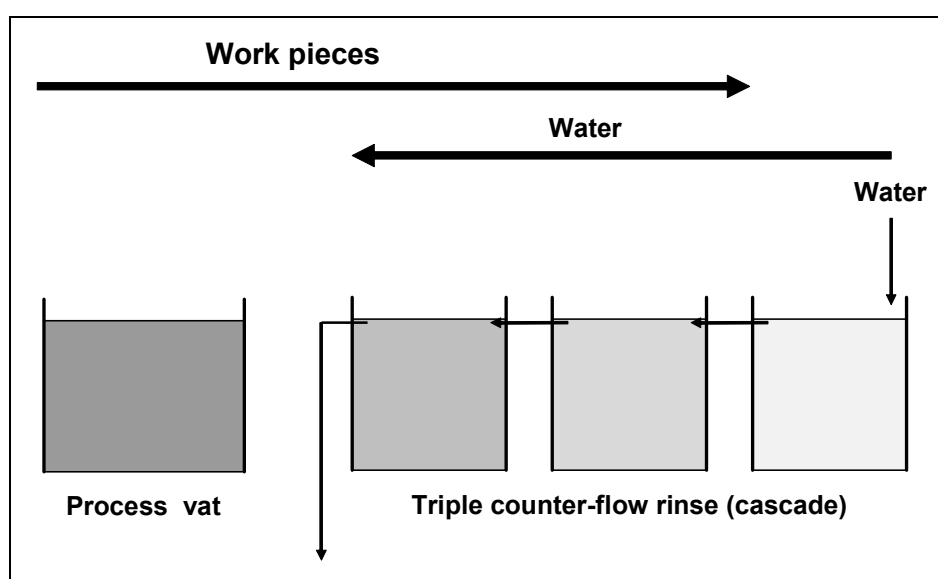

Figure 4.7: Multi-level rinsing technology (cascade technology) [104, UBA, 2003]

Overall achieved environmental benefits for all options described

Multiple rinsing techniques play an important role in reducing water usage and materials recovery. The zero discharge (or squared water balance) is often seen as the ultimate criterion of the rinsing technology for a surface treatment process low in emissions and requires additional techniques to prevent all water discharges (see Section 4.16.12). However, closing the loop for materials for specific process chemistries within a process line is more readily achievable, see Section 4.7.11.

Closing the loop for a process requires the water returned to the process solution from the first rinse station to be brought into balance with the water lost in evaporation and drag-out. Process solutions operated at higher temperatures and with multi-stage rinsing offer possibilities for this (see Sections 4.7.11.2 and 4.7.11.3). By the introduction of multistage rinsing systems partly combined with a rinsing water recycling system and other techniques (see Section 4.7.11) and decreases of waste water of up to 90% can be obtained. One coil coating plant reports a reduction of 30 m³ per hour.

Table 4.8 shows drag-out recovery rates achievable with different multiple rinse techniques, taking the respective values of the reference lines as basis. Good practice for the rinse criterion after both main processing steps is a minimum $R = 1000$, for the examples given here: medium cyanide zinc barrel plating and bright nickel jig plating (see Table 4.7).

Rinse technique	Recovery rates Medium cyanide zinc barrel	Recovery rates Bright nickel, jig
Triple counter flow rinse	<24 %	<57 %
This technique does not provide satisfactory recovery rates in a barrel plant since $WD > 3WR$ (see formulas, 4.7.10.1). If no major additional investment is necessary, a rate of 57 % in jig plant seems attractive.		
Triple static rinse	>40 %	>95 %
The necessity of changing rinse-water already after less than eight hours operation in barrel plating plant makes this technique difficult to apply, whereas in jig plant the rinse-water has to be changed no earlier than 56 hours operation and the recovery rate of >95 % can be attained again without major additional investment		
Dual static rinse plus flow rinse	>90 %	>98 %
When a high drag-out recovery is required, this technique should be used in barrel plating. Changing of rinse-water is required after 24 hours operation. The installation of an appropriate ion exchanger plant or a counter-flow rinse system will minimise the use of water.		

Table 4.8: Achievable recovery rates for some multiple rinse techniques

Overall cross-media effects for all options described

There are none for multiple rinsing on its own.

If used in conjunction with other techniques, there may be increased energy if evaporation or other concentration techniques are used (see Section 4.7.11) and chemicals for regeneration if deionisation is used

Overall operational data for all options described

A combination of spray rinsing, particularly if carried out over the process solution, as part of a multiple rinsing system may combine the advantages of multiple stage water usage reduction with minimum extra space requirement. It may also reduce water usage further.

Overall applicability of all options described

There are options and combinations suitable for most types of installations. In some cases, this may be limited by the need for single rinsing, see Section 4.7.9.

A build-up of breakdown materials which may reduce process quality is likely unless other solution maintenance measures are taken, see Section 4.11.

Overall economics for all options described

Generally the installation of multistage rinsing techniques is associated with higher space requirement and higher investments (costs for additional tanks, workpiece transport equipment and control). The decrease of the water consumption, recovery of process chemicals and the smaller effluent discharge, which requires a smaller waste water processing facility and less treatment chemicals, reduces the total costs.

The economics for the recovery of materials and the reduction of water usage, vs. the cost of increasing the number of rinse tanks in a rinsing stage, amendments to plant, etc. can be calculated using the data in this section, with specific plant data. It can also be calculated using software tools for plant optimisation, see Section 4.1.4 and Annex 8.11 for examples of rinsing after cleaning, after pickling, after electrocleaning, after plating and in conjunction with forced evaporation, as well as after passivation.

One example plant avoided the need to construct a waste water treatment plant by using multistage cascade rinsing combined with process solution evaporation, see Section 4.7.11.3.

Overall driving force for implementation for all options described

See Overall economics for all options, above.

Example plants

SGI, Plaisir, France, Sikel N.V., Genk, Belgium, Exhall Plating Ltd, Coventry, UK. Frost Electroplating Ltd., Birmingham, Merrydale Ltd, Wednesbury, UK; Bodycote Metallurgical Coatings, Uxbridge, UK, Annex 8.5.8, Germany

Reference literature

[3, CETTS, 2002, 18, Tempany, 2002, 104, UBA, 2003], [159, TWG, 2004]

4.7.10.1 Multiple stage counterflow rinse

Description

This is shown in Figure 4.8, with drag out recovery. The rinse ratio R achievable with counter flow rinsing can be calculated as

$$R = C_0/C_n = (q^{(n+1)}-1)/(q-1)$$

where $q = W/D$

- R = rinse ratio
- C_0 = concentration of chemicals in process solution
- C_n = concentration of process chemicals in last nth rinse station
- D = quantity of drag-out,
- n = number of counterflow rinses

W = quantity of rinse-water to achieve R at a given D,

A triple counter flow recovery rinse is shown in Figure 4.8, below.

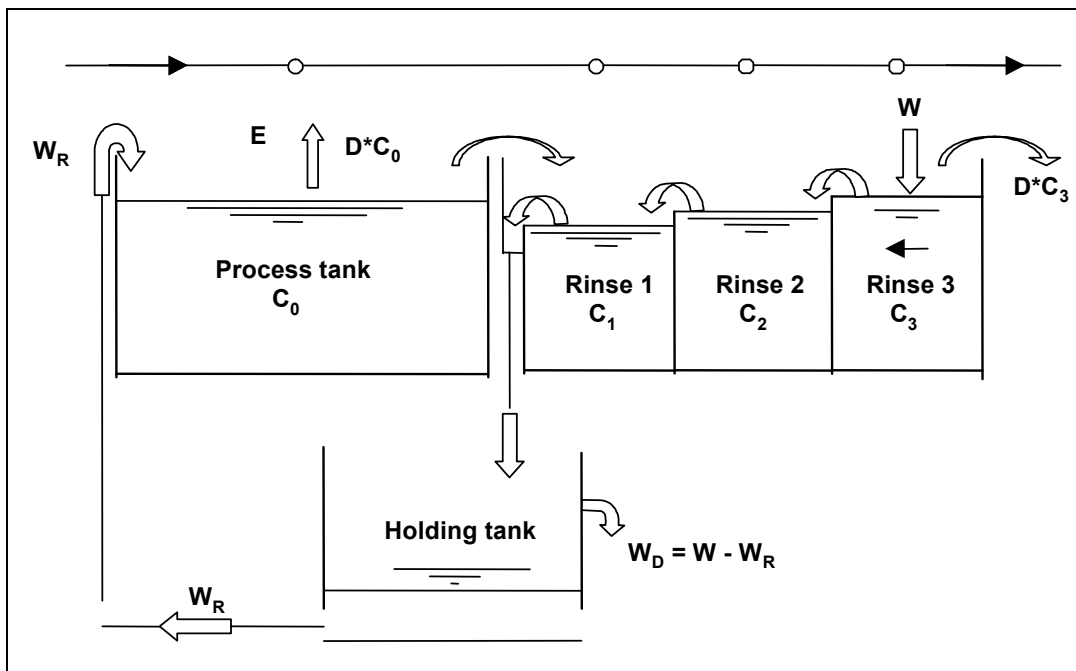

Figure 4.8: Recovery of drag-out with a triple counter flow rinse

In cases where $E \geq W$, the drag-out recovery rate is:

$$Rc_R = 1 - C_3/C_0$$

In cases where $E = WR < W$, drag-out recovery rate is reduced to:

$$Rc_R = (1 - C_3) * W_R/W$$

C_0	=	concentration of chemicals in process solution
C_3	=	concentration of process chemicals in rinse station 3
E	=	evaporation losses
Rc_R	=	recovery rate of drag-out
W	=	quantity of rinse-water used
W_D	=	quantity of rinse-water to be discharged
W_R	=	quantity of rinse-water available for drag-out recovery.

Figure 4.6 shows the specific water consumption of triple and quadruple counter flow rinses in litres per litre drag-out.

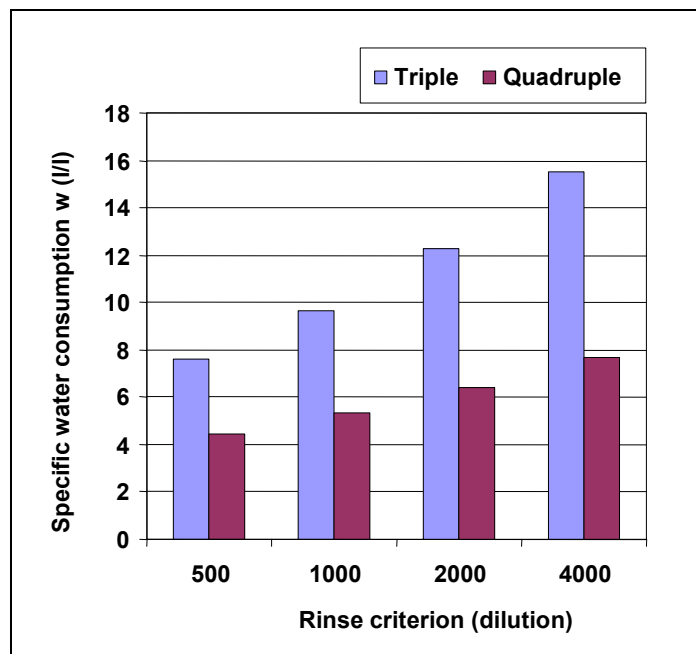

Figure 4.9: Specific water consumption 'w' of triple and quadruple counterflow rinses

4.7.10.2 Multiple static rinse

Description

Multiple static rinsing instead of counter flow rinsing allows for reduced water consumption [3, CETS, 2002].

Figure 4.10 shows the arrangement of tanks and the process sequence of a triple static rinse.

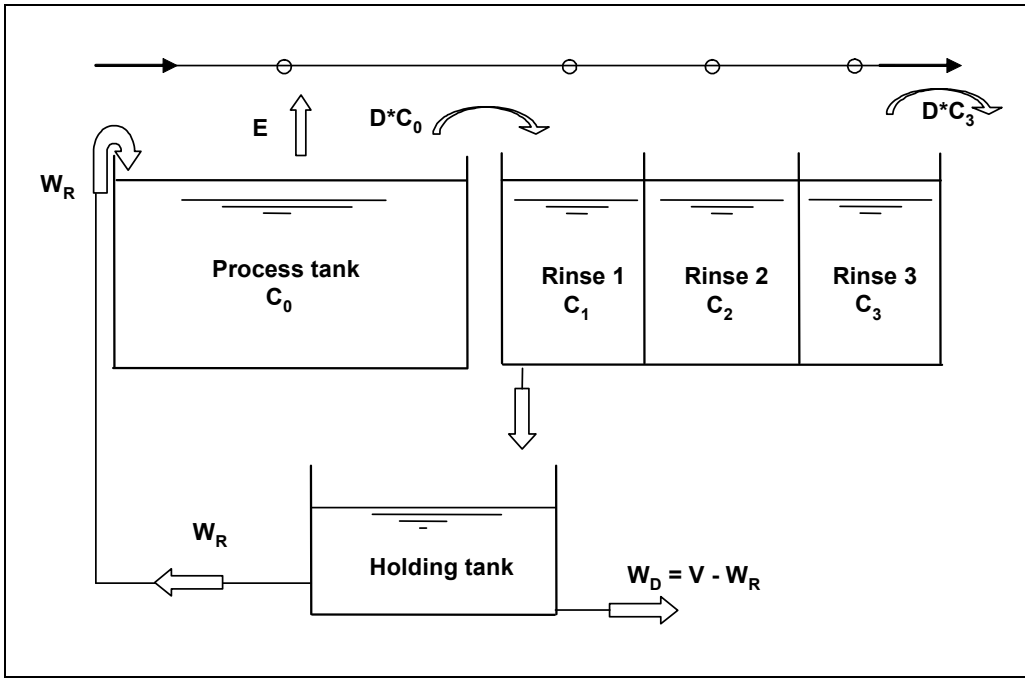

Figure 4.10: Recovery of drag-out with triple static rinse

Instead of continuous inflow and overflow, rinse 1 is discharged into holding tank only when C_3 has reached its set value. Rinse-water from tank 2 than is pumped into tank 1 and water from tank 3 into tank 2. After tank 3 has been filled with fresh water, processing can be continued.

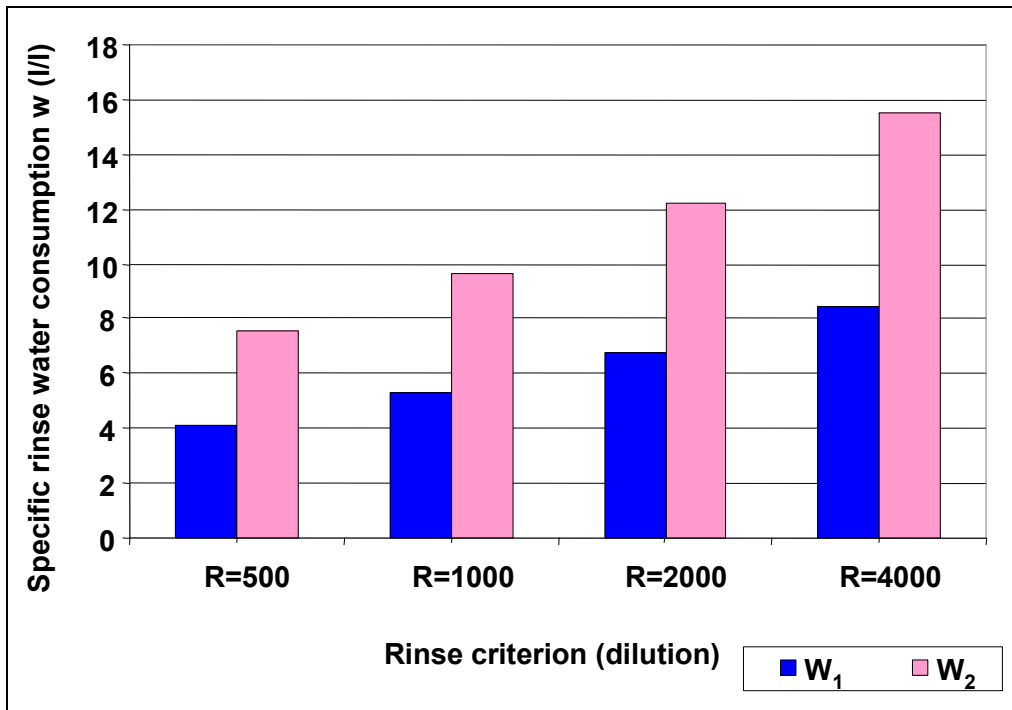

Figure 4.11: Specific water consumption in litre per litre of drag-out W_1 triple static vs. W_2 triple counter flow rinse
(Values for W_1 valid when all three tanks are filled with fresh water)

As Figure 4.11 shows, savings of water compared with counter-flow rinsing are substantial: savings of approximately 45 %, when all rinse tanks are filled with fresh water, and approximately 40 %, when water from tank 2 has been filled into tank 1 and tank from tank 2, as it is done at normal operation.

The concentration of process chemicals in static rinses 1, 2, 3 can be calculated with the following equations:

$$C_{1n} = C_0 (1 - q^n)$$

$$C_{2n} = C_0 \{ 1 - (n+1) * q^n + n * q^{(n+1)} \}$$

$$C_{3n} = C_0 \{ 1 - (1/2) * (n+1)(n+2) * q^n + n * (n+2) * q^{(n+1)} - (n/2)(n+1) * q^{(n+2)} \}$$

C_0	= concentration of chemicals in process solution
$C_{1,2,3n}$	= concentration of process chemicals in rinse station 1, 2, 3, etc. after n workloads rinsed
D	= quantity of drag-out
n	= number of workloads rinsed
V	= volume of water per rinse station.
q	= $V/(V+D)$

4.7.10.3 Dual static rinse followed by final flow rinse with recirculated water

At comparatively high drag-out rates, even triple counter flow or static rinses might not be sufficient for satisfactory drag-out recovery. A modified triple rinse is shown in Figure 4.12.

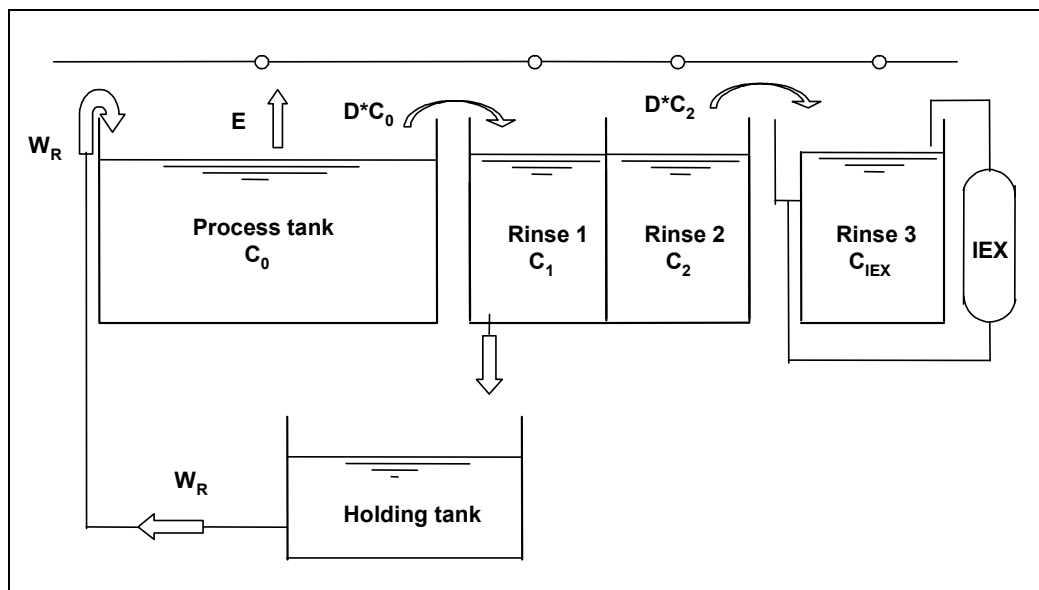

Figure 4.12: Dual static rinse followed by single flow rinse with recirculated water, continuously purified in ion exchangers (IEX)
[104, UBA, 2003]

Description

Rinse 1 is discharged into a holding tank after a period of time depending on the mode of operation of the line. In this example, this would be after three shifts or 240 rinsed barrels (Figure 4.12).

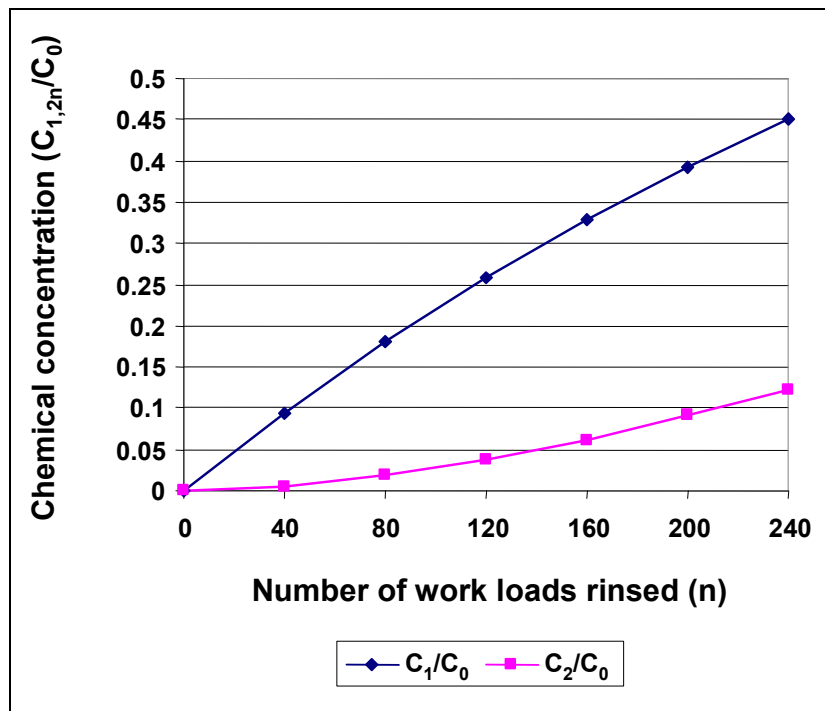

Figure 4.13: Increase of chemical concentration C_1 and C_2 related to number of rinsed barrels

This technique allows for concentrations $C_2 \leq 0.2 C_0$, equalling an average value of approximately $0.095 C_0$, starting from 0 and ending at $0.2 C_0$. The area below curve C_2/C_0 is equivalent to the quantity of chemicals loaded on the ion exchangers. The design flowrate of recirculated water has to be high as the ion concentration must not exceed 2 mVal per litre.

The final rinse in recirculated water provides a sufficiently high rinse rate (or criterion) at low water consumption (approximately 5 % of flowrate).

Reference Literature

[3, CETS, 2002]

4.7.10.4 Multi-cascade rinsing with limited process line space

Description

In the case of existing plants, the use of a larger number of tanks is often not possible within the plant because of reasons of space. In such cases, the employment of so-called external cascades (where the cascades are external to the process line) may be possible. In the treatment line there is only one rinsing tank per process step. Each rinse tank is connected to several external tanks which work as rinsing stages according to the cascade principle. The workpieces or substrates are brought into the rinsing tank and rinsed successively with the water from the individual rinsing stage tanks, becoming progressively cleaner. Rinsing can be by sprays or filling the tank to immerse the workpieces or substrates. Figure 4.14 shows a spray rinsing system with the first rinse holding tank being concentrated. The concentrate is returned to the process solution and the cleaned water returned to the final rinse holding tank. Concentration techniques are described in 4.7.11.

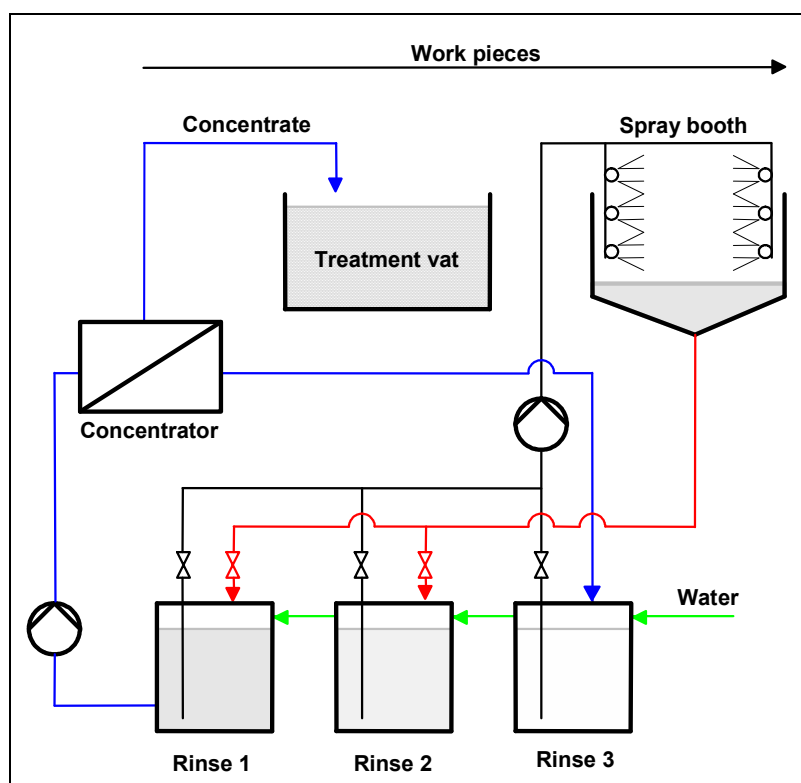

Figure 4.14: External cascade system: Single spray compartment with external cascade and concentrate recycling

Operational data

Gives quality problems if rinse-water contains solid particles, especially with alkaline water

Reference Literature

[104, UBA, 2003], [113, Austria, 2003].

4.7.11 Increasing drag-out recovery rate and closing the loop

Where the quantity of water needed for appropriate rinsing (to achieve process control and product quality) exceeds evaporation losses, and recovery rates $>90\%$ are expected, the amount of water in the drag-out recovery system has to be decreased. This is achieved by a combination of techniques.

In some cases, drag-out can be recovered until the loop can be closed for process chemicals by applying a suitable combination of techniques. Closing the loop refers to one process chemistry within a process line, not to entire lines or installations,

Closed loop is not zero discharge: there may be small discharges from the treatment processes applied to the process solution and process water circuits (such as from ion exchange regeneration). It may not be possible to keep the loop closed during maintenance periods. Wastes and exhaust gases/vapours will also be produced. There are also likely to be discharges from other parts of the process line, such as rinsing after degreasing or etching.

Increasing drag-out recovery can best be considered with other processes and activities, such as recycling and re-using water and an overall approach derived for the installation, see Operational data, below.

Increasing drag-out recovery and closing the loop require techniques to:

- reduce drag-out, see Section 4.6
- reduce rinse-water (such as by cascade rinsing and/or sprays) with drag-out recovery, see Section 4.7
- concentrate the returning drag-out or receiving solutions, such as by ion exchange, membrane techniques, or evaporation, see Section 4.10. The water removed during concentration (such as from evaporation) can often be recycled back into the rinse.

Examples of techniques for this purpose are, for example:

- addition of an eco rinse tank
- evaporation using surplus internal energy
- evaporation using additional energy (and in some cases, low pressure)
- electrodialysis
- reverse osmosis.

The principle of rinse-water removal and chemical concentration is shown in Figure 4.15. The concentrate is used to replenish the process solution whilst the condensate can be reutilised as rinse-water.

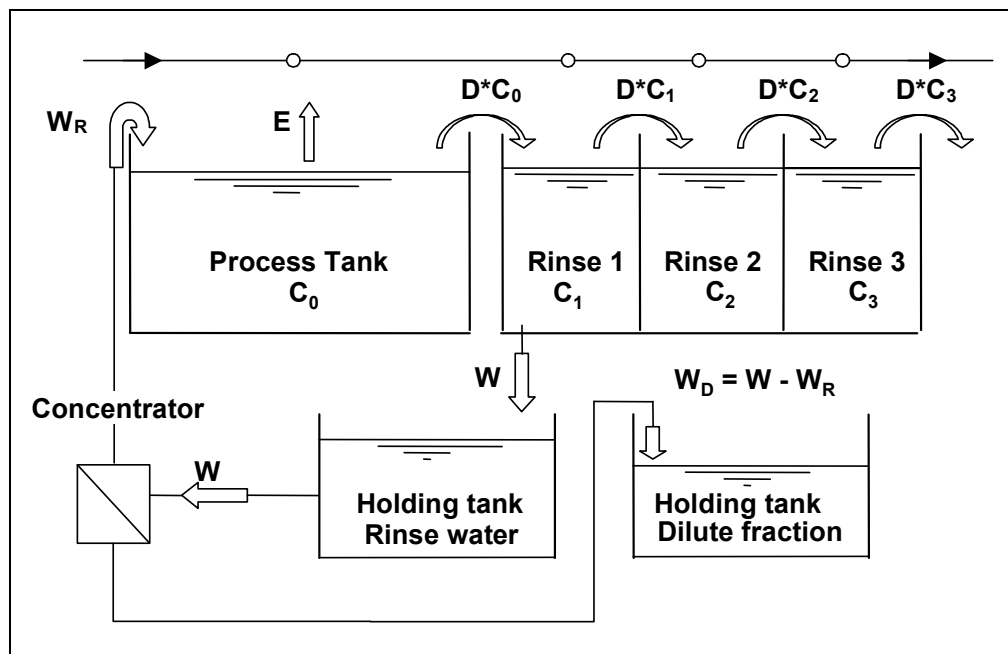

Figure 4.15: Rinse-water and chemical recovery through concentration

Achieved environmental benefits

See Overall achieved environmental benefits, Section 4.7.10.

Closing the loop achieves a high raw material utilisation rate and in particular can:

- reduce the use (and therefore cost) of raw materials and water
- as a point-source treatment technique, achieve low emission limit values
- reduce the need for end-of-pipe waste water treatment (e.g. removing nickel from contact with effluent containing cyanide)
- reduce overall energy usage when used in conjunction with evaporation to replace cooling systems
- reduce the use of chemicals for treating the recovered materials that would otherwise be discharged in the waste water
- reduce the loss of conservative materials such as PFOS where used.

Cross-media effects

See Overall applicability, Section 4.7.10.

The lifetime of the process baths may be affected by the recycling of contaminants, and may require additional maintenance.

Energy is used for concentration techniques, although this is less for processes that gain heat from the electrochemical reactions, such as hexavalent Cr(VI). Energy is also used for pumping and pressure filtration techniques.

Chemicals are used in some concentration techniques, such as ion exchange.

Operational data

See individual techniques, Section 4.7.10.1 to Section 4.7.10.4.

It is good practice to consider increased drag-out recovery with other options for the whole installation. These can include combining compatible streams from different processes for purification/recovery,

Applicability

Increasing drag-out recovery is widely practised. Some techniques require additional energy, which means cost, which may be offset by savings in cooling energy and drag-out recovery. The chemical content of the rinse-water to be processed also affects the appropriate choice.

Closing the loop has been successfully achieved on some substrates for:

- precious metals
- cadmium
- barrel nickel plating
- copper, nickel and hexavalent chromium for decorative rack plating
- hexavalent decorative chromium
- hexavalent hard chromium
- etching copper from PCBs.

The type of system installed will depend on the existing infrastructure, and plant as well as the process type.

Economics

See Overall applicability, Section 4.7.10. These will be site-specific.

Capital and running costs of the techniques may be offset by increased recovery of process chemicals, which can be >95%. Also, these techniques can reduce running costs and/or investment in a waste water treatment plant. Extra steps cause a loss in process line capacity (an increase in the number of cycles).

Planning calculations can be assisted by software tools, see Section 4.1.4 and Annex 8.11.

Driving forces for implementation

See Overall economics, Section 4.7.10.

Reduced costs.

Example plants

See individual techniques, Section 4.7.10.1 to Sections 4.7.10.4 and 4.7.11.5, and Reference Plants K and L, Annexes 8.5.8 and 8.5.9).

Bodycote, Uxbridge, UK (formally West Middlesex Plating)

Merrydale, Wednesbury, UK

Reference literature

[3, CETS, 2002, 104, UBA, 2003], [18, Tempany, 2002, 48, France, 2003, 49, France, 2003, 55, France, 2003, 113, Austria, 2003, 162, USEPA, 2000]

4.7.11.1 Addition of an eco rinse tank

Description

The operation of an eco tank is described in Section 4.7.4. This alone can recover 50 % of drag-out; and can assist in achieving rates of above 50 %. The total rate can be calculated when 50 % of the values in Table 4.8 are taken, for instance, triple static rinse in barrel plating:

$$R_{cR \text{ total}} = 50 \% + 0.5(40) \% = 70 \%,$$

equivalent to an increase of 75 % and a reduction of rinse-water by >20 %.

Achieved environmental benefits

May be considered where other alternatives are not achievable or as part of several rinses steps.

Cross-media effects

See Section 4.7.4

Operational data

See Section 4.7.4. Requires additional process line space as well as an additional process station programming into automatic lines.

Applicability

Adding an eco rinse tank requires additional space on the process line

Can also be used for minimising chemical usage for metal plating baths, where the concentration of metal and other ions must be increased by salts to maintain a certain level. For some processes, pre-dip can cause problems, see Section 4.7.4

Economics

See Overall economics Section 4.7.1.

Driving force for implementation

See Overall economics Section 4.7.1.

Reference literature

[3, CETS, 2002] [113, Austria, 2003]

4.7.11.2 Evaporation using surplus internal energy

Description

Evaporation is atmospheric and achieved here by using the surplus heat energy in the process generated because of the poor electrical efficiency of the solution. The amount of energy necessary for evaporating corresponds roughly to the energy which is released in the process tank as heat energy thus the system is energetically self-sufficient. The rate of evaporation can be increased by using air agitation, or an evaporator (see 4.4.4.2). In this case, the process solution is pumped through the evaporator where it meets an air stream blown through the evaporator to the atmosphere. The evaporator chamber is usually filled with packing material to increase the water evaporation surface. Heated evaporators are described below in Section 4.7.11.3

Evaporation from the process can be due to:

- an elevated processing temperature, such as >80 °C for electroless nickel and >55 °C for electrolytic nickel and phosphating at >90 °C (see Figure 4.16)
- cooling of the process solution by evaporation to maintain a constant processing temperature, such as in cyanide zinc barrel plating at <25 °C, bright chromium at 40 °C and hard chromium at 60 °C.

The evaporation of 1 litre of water requires approximately 1.4 kWh.

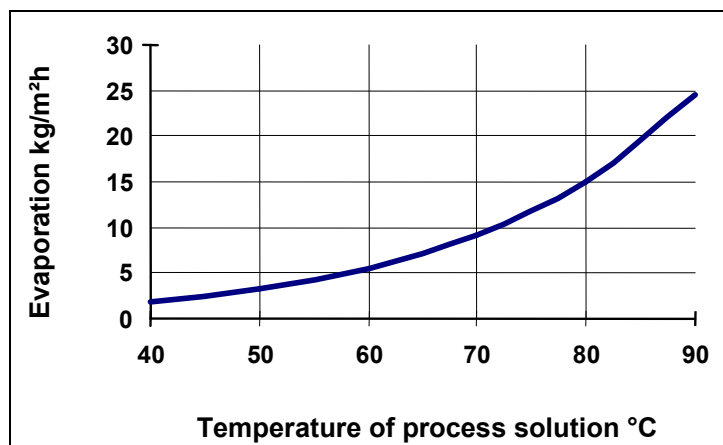

Figure 4.16: Specific water evaporation from process solutions, with fume extraction at the process tank

The evaporation losses in operating parameters in the previous example can be calculated as follows:

Jig plating

- surface area of plating solution 6 m²
- water evaporation at 60 ° 5.5 litres/m²h
- water evaporation 33 litres/h.

Barrel plating

- plating energy/barrel 2.5 kWh
- plating energy total 25 kWh
- water evaporation equivalent 35 litres/h.

An example calculation is given in Annex 8.11 for zinc barrel plating and examples are shown in Annex 8.5.

Equivalent quantities of rinse-water with diluted process solution can be added back into the process tank. The recovery rate is directly related to the concentration of process chemicals in rinse-water, and this again depends on the chosen rinse technique. A choice of appropriate technique is outlined below.

Even if there is no significant evaporation, a technique for drag-out recovery is shown in Section 4.7.4.

Achieved environmental benefits

Higher recovery of drag-out.

Can be part of closing the loop for specific process steps.

Cross-media effects

Reduction in the need for cooling systems.

Possible aggressive fume formation at higher operating temperatures in some processes.

Extraction of the vapours from the process is part of the evaporation. The extracted air may need scrubbing. Scrubbing liquors may be treated in a typical waste water treatment plant.

Decomposition products are concentrated, so additional solution maintenance is required

Operational data

Evaporation is most readily used with process solutions working at elevated temperatures, in particular chromium electrolytes. In connection with multistage rinsing technology (in practice up to five rinsing stages), the procedure can be operated almost waste water free. Sufficient evaporation can occur at an ambient temperature. In hexavalent chromium plating, chromic acid dragged out from the process bath into the rinses is virtually completely recovered to the solution. Minimum chromium acid losses are to be expected through the exhaust air and with the regeneration of the electrolytes.

Evaporation can be increased by using air agitation and/or an evaporator to increase the surface area (see Sections 2.7.4, 2.7.5 and 4.7.11.3).

Applicability

All process solutions, particularly those with poor electrical efficiency where the process solution heats and is often cooled by evaporation (see Section 4.4.4.2). Hexavalent chromium electrolytes are particularly suitable for this technique.

May also be used with chemical solutions with a high heat of reaction.

Regional weather patterns may also affect applicability.

Economics

Requires little or no capital installation.

Driving force for implementation

See Overall economics, see Section 4.7.10.

Example plants

See reference plants in Annex 8.5

Reference literature

[18, Tempany, 2002, 104, UBA, 2003], [124, Germany, 2003] [113, Austria, 2003].

4.7.11.3 Evaporation using additional energy with an evaporator

Description

In electrochemical installations, atmospheric evaporators are used for the concentration of rinsing water, which are fed back into the process tank. Industrially used evaporators usually work at temperatures between 20 and 200 °C and at operating pressures between 0.1 and 1 bar. Usually the evaporators used in electroplating shops are equipped with energy recovery (vacuum evaporators with vapour consolidating or heat pump) and need approximately 150 – 200 kWh per cubic metre of evaporated water.

The principles of (natural process) evaporation (see Section 4.7.11.2) and evaporators are approximately the same, yet the evaporator is more universally applicable in practice, since its performance is adjustable independently of the process conditions, (see Sections 2.7.4 and 2.7.5)

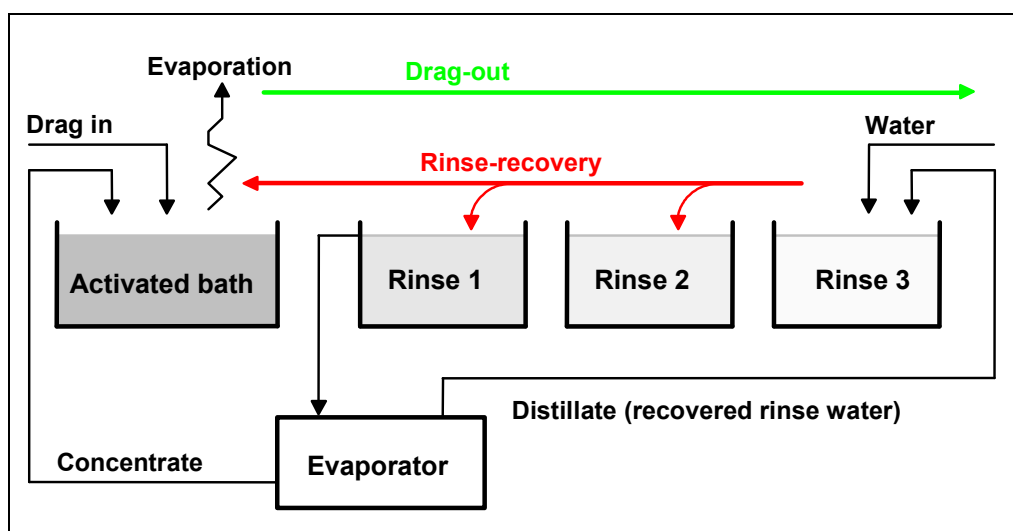

Figure 4.17: Schematic diagram of the evaporator

Achieved environmental benefits

See Overall achieved environmental benefits, see Section 4.7.10.

Cross-media effects

Additional energy in the order of 150 – 200 kWh/m³ of water may be used in evaporators, either as heat input and/or reducing pressure.

To prevent contaminated water droplets being emitted to the air, the evaporation tank can be equipped with a mist eliminator at the outlet side. The performance of the evaporation tank depends on the air temperature and humidity, and there are likely to be significant regional variations

Operational data

With the evaporation of diluted electrolytes at normal boiling temperature of the water, organic additives of the electrolytes can be destroyed. Vacuum evaporator systems have therefore been developed which work at much lower pressures and low temperatures. Due to high demands on the materials in such systems, they are more expensive than simpler systems.

Applicability

All process solutions that are heat stable.

Although not dependent on surplus energy in the process bath (see Section 4.7.11.2), the process will work most effectively with hot solutions, or those with poor electrical efficiency where the process solution heats and is often cooled by evaporation (see Section 4.4.4.2)

Regional weather patterns may also affect applicability.

To ensure appropriate investment all process chemicals contained in the process solution must be tested for their application in an evaporation system before introduction of the technique.

In addition to the evaporation of chromium electrolytes, evaporators are also used for concentration of rinsing waters from the acid or cyanide zinc, nickel and cadmium electroplating. With zinc solutions, there is a tendency for the electrolytes to form foam which requires additional treatment.

Evaporators are increasingly used for electrolyte feedback from rinsing waters. The complete closing of material cycles with an evaporator enabling the complete feed back of rinse-water for certain process stages is achievable.

Economics

See Overall economics, Section 4.7.10.

There is a capital cost for installation of the evaporator (with or without vacuum), usually with a storage tank. There are additional energy costs, although these may be marginal with hot solutions. Cost savings come from recovered materials, reduced use of effluent treatment materials and in some cases, reduced capital investment in a waste water treatment plant.

The economics for the recovery of materials and the reduction of water usage, vs. the cost of increasing the number of rinse tanks in a rinsing stage, amendments to plant, etc. can be calculated using the data in this section (with specific plant data). It can also be calculated using software tools for plant optimisation, see Section 4.1.4 and Annex 8.11 for examples for rinsing after cleaning, after pickling, after electrocleaning, after plating and in conjunction with forced evaporation, as well as after passivation.

Driving force for implementation

See Overall economics, Section 4.7.10

Example plants

Frost Electroplating Ltd, Birmingham, UK; Merrydale, Wednesbury, UK, Sikel N.V. Genk, Belgium, Disflex France (Breuil le sec), TMN (Notre Dame de Gravenchon), France, ACRODUR (Carrière sur Seine), France (see Section 4.7.11.6).

Reference literature

[18, Tempany, 2002, 104, UBA, 2003], [119, Eurofer, 2003], [124, Germany, 2003], [124, Germany, 2003], [119, Eurofer, 2003, Czech, 2003 #116].

4.7.11.4 Electrodialysis

Description

The electrical dialysis is a diaphragm procedure, in which an electrical field forces material transport. Anions and cations are removed from solutions with an applied electric field in cells with alternating anion- and cation-permeable membranes. It is used both for the concentration of diluted solutions and for the demineralisation of water.

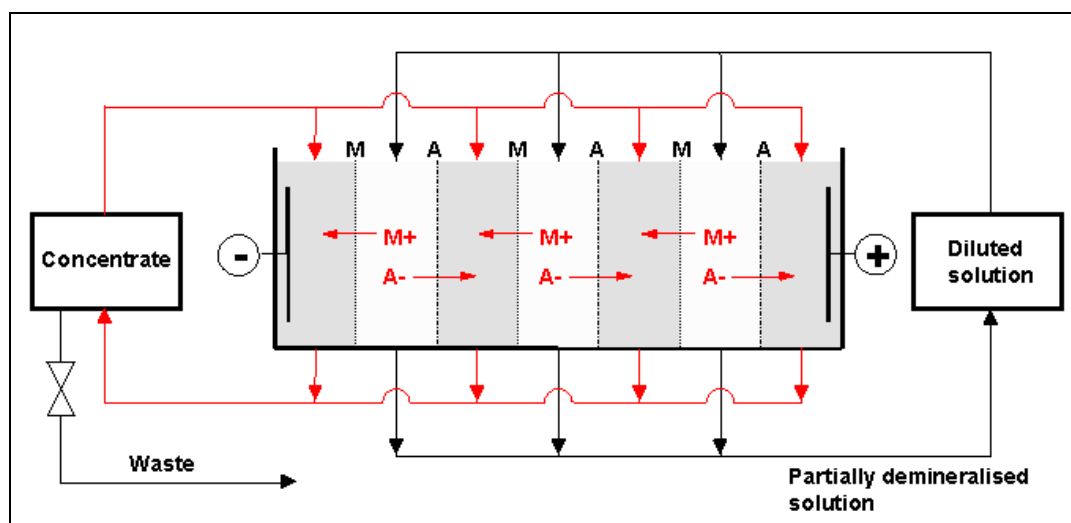

Note: M^+ = cation, A^- = anion

Figure 4.18: Operational principle of the electrical dialysis

[104, UBA, 2003]

Achieved environmental benefits

Reduced water consumption.
Increased drag-out recovery.

Cross-media effects

Requires energy inputs.

Operational data

To achieve long service life of the diaphragms:

- the diaphragms must be protected by a pre-filtration stage against mechanical pollution
- the blocking of the diaphragms by organic materials (such as oils) must be prevented
- blocking at the diaphragm surface can be avoided by regular rinsing and polarity reversal (pole changes).

Applicability

Has been used in surface treatment to recover nickel salts from rinse-water.

Economics

Criteria for an economic application of electrical dialysis are the service lifetimes of the diaphragms, the efficiency of the plant in separating components and the yield per kWh.

Reference literature

[104, UBA, 2003], [113, Austria, 2003, 162, USEPA, 2000]

4.7.11.5 Reverse osmosis – closed loop electroplating**Description**

Reverse osmosis (RO) uses a hydrostatic pressure gradient across a semi-permeable membrane to separate water from a solution of salts. The pressure applied exceeds the osmotic pressure of the feed solution causing water to flow from the concentrated solution to the more dilute solution: the reverse of the natural osmotic diffusion. Dissolved solids are rejected by the membrane surface. Many multi-charged ions can be rejected at rates exceeding 99 %. Single-charged ions typically have rejection rates in the range of 90 - 96 %.



Figure 4.19: Reverse osmosis plant
Menoni S.A. and Agence de l'eau Seine-Normandie

Achieved environmental benefits

Used to concentrate rinse-waters and recover materials, treat waste waters and incoming or recycled water.

Cross-media effects

Energy required for maintaining pressure.

Operational data

Reverse osmosis is used in the surface finishing industry for purifying rinse-water and for recovery of chemicals from rinse-waters. It has also been used to purify raw water for the generation of high-quality deionised water in rinsing and plating solutions. Figure 4.19 presents a reverse osmosis flow schematic for rinse-water applications. Reverse osmosis applications involving the separation of plating chemical drag-out from rinse-water have been applied mainly to nickel plating operations (sulphamate, fluoborate, Watts and bright nickel). Other common applications include copper (acid and cyanide) and acid zinc. Recently, RO has been applied successfully to chromate rinse-water. In the typical configuration, the RO unit is operated in a loop with the first rinse following plating. The concentrate stream is recycled to the plating bath and the permeate stream is recycled to the final rinse. Reverse osmosis is commonly used for water treatment (with and without ion exchange) applications requiring production of high-quality water from high total dissolved solids (TDS) sources. Large scale waste water recycling is evolving as an important application for RO in the surface finishing industry.

Membrane performance of all polymer-based membranes decreases over time and permeate flow (flux) and membrane rejection performance are reduced. RO membranes are susceptible to fouling by organics, water hardness, and suspended solids in the feed stream or materials that precipitate during processing. Installing prefilters can control solids in the feed stream. Changing operational parameters, such as pH, inhibits precipitation. Oxidising chemicals like peroxide, chlorine and chromic acid can also damage polymer membranes. Acid and alkaline solutions with concentrations greater than 0.025 molar can also deteriorate membranes. In most applications, the feed solution will have significant osmotic pressure that must be overcome by the hydrostatic pressure. This pressure requirement limits the practical application of this technology to solutions with total dissolved solids concentrations below approximately 5000 ppm (with the exception of disc tube applications). Specific ionic levels in the concentrate must be kept below the solubility product points to prevent precipitation and fouling. Ionic species differ with respect to rejection percentage. Some ions such as borates exhibit relatively poor rejection rates for conventional membranes.

Applicability

See Operational data, above.

Economics

See Example plant, below. Payback can be short (see Example Plants, BGT Eindhoven)

Driving force for implementation

Materials recovery, water recovery, reduced investment and running costs in a typical waste water treatment plant

Example plants

BGT Eindhoven, Netherlands

Disflex France, Breuil le Sec, France.

The following data are for: Disflex France

Nickel is deposited on a flexible support before decorative chromium plating.

Water from the first cascade rinsing is recovered. This water is rich in nickel because of the drag-out, and is passed through activated carbon and it is sent to a buffer tank. The solution is pumped at 20 bars pressure through the membranes of the reverse osmosis unit. The recovered nickel solution is returned to the treatment bath and the water is reintroduced in the first stage of the cascade rinsings.

The process conditions are:

- nickel bath temperature: 60 °C
- nickel bath volume: 6000 l
- nickel bath concentration: 80 g/l
- five cascade rinsing tanks, volume: five tanks at 400 litres
- buffer tank volume (after activated carbon and before reverse osmosis): 300 litres

Nickel concentration of the different cascade rinsings to judge the system efficiency:

- nickel bath = 80g/l
- rinse 1 Ni = 6.3 g/l
- rinse 2 Ni = 1.6 g/l
- rinse 3 Ni = 0.54 g/l
- rinse 4 Ni = 0.250 g/l (250 mg/l)
- rinse 5 Ni = 0.065 g/l (65mg/l).

The size of the reverse osmosis unit is not large and comprises two blocks of membranes each one metre long.

Benefits

Recovery of nickel solution, both metal and other additives.

Reduced waste water treatment costs.

Reduced water consumption.

Economics

For this example:

- electric consumption of the pump: 2.5 kWh
- membrane maintenance costs (change and cleaning): EUR 2000 for 3 years
- monitoring of the system (in time and manpower), levels control and filters cleaning:
- 1 hour each day
- cost of a reverse osmosis unit: EUR 30 000.

Other driving forces for implementation

There is no loss of nickel to solid waste or water. All the nickel bought is deposited, so there is 100 % efficiency.

Better quality of the products because rinsing is more effective.

Reference literature

[55, France, 2003, 162, USEPA, 2000, 166, RIZA, 2004]

4.7.11.6 Electrolytic chromium plating - closed loop electroplating

Description

Hexavalent Cr(VI) plating can be operated as closed loop for chromium. This is achieved by a combination of cascade rinsing and an evaporator to ensure that the rinsing water is in equilibrium with the evaporation.

Ion exchange is used to remove accumulated impurities.

Achieved environmental benefits

There are no discharges of Cr (VI) or other materials from the process to waste water. This minimises the capital cost of treatment and the use of chemicals and energy in treatment.

Chromic acid and other components (such as foam suppressants, e.g. PFOS) are recycled in the process.

Cross-media effects

The baths of hexavalent Cr(VI) plating are polluted by inorganic cations from the treated metals and the reduction of the chromic acid. These impurities must be maintained at low concentration in order not to disturb the chromium plating operation.

Energy is used to assist in evaporation

Operational data

The plating bath is followed by reversed cascade rinsing. The rinsing water is treated on cationic resin (to retain Cr(III) and other cations) and then concentrated on an evaporator to get a concentrate rich in chromic acid. This acid is sent back to the working bath. The distillate is recycled in the rinsing step.

The evaporator reduces the rinsings until a concentration of 250 – 280 g/l is obtained, or an intermediate concentration (120 g/l), which can be returned to the plating solution, where the natural evaporation of the bath contributing to the concentration.

There is an efficiency optimum which is a compromise between the necessary consumption of electricity for the evaporation and the consumption of used water for the rinsing refeeding.

The equipment size depends on the pollution drag-out quantity. The evaporation flows are between generally 60 and 200 l/h.

Ions exchangers collect the metal cations on the rinsings before evaporation. The regeneration of the ions exchangers is carried out in a hazardous waste treatment centre.

There is the possible problem of corrosion, depending on the alloy quality of the evaporator.

Applicability

All Cr (VI) plating plants.

Economics

Capital cost will be site dependant on existing plant and drivers, such as the need to reduce Cr(VI) discharges, increase waste water treatment plant capacity, etc. There are higher maintenance and energy costs.

Driving force for implementation

Example plants

Disflex France (Breuil le sec), TMN (Notre Dame de Gravenchon), ACRODUR (Carrière sur Seine)

Reference literature

[48, France, 2003]

4.7.12 Combining techniques and installation-wide approaches

General Description

Techniques can be used in combination more widely within the installation to achieve the overall environmental objectives for the installation (see 4.1.1 (a) and (b)).

The preceding sections (4.4.5.3, 4.5, 4.6 and 4.7) describe point source techniques based on one process or process line to:

- reduce water consumption by recovering and re-using water
- reduce materials consumption by recovery and re-use.

These and other techniques can be used to further the objectives above for the whole installation as well as to minimise waste waters and waste water treatment. However, this needs an overall view taking into account, for example:

- the details of the objectives
- the existing equipment (including infrastructure such as existing waste water treatment plant), existing or planned changes in process
- the condition/suitability of the equipment for the current or planned tasks
- pressures for change, such as meeting environmental quality standards
- costs, including point in the depreciation curve for existing equipment.

There are trade-offs between the point source options and centralised or combined systems for purification/recovery. For example, a single fixed location recovery systems (e.g., centralized reverse osmosis/ion exchange for recycling rinse-waters from several process lines). Another combined strategy would be to use a mobile system to perform intermittent purification/recovery of several point sources. For example, a single mobile diffusion dialysis system might be used to purify/recycle several different acid baths. Combined strategies may be more cost-effective, due to economy of scale, unless there are substantially increased plant interface requirements: for example, a typical waste water treatment plant is based on combining all the flows (see Sections 2.13.1 and 4.16). Point source systems, in part or completely, may offer more flexibility, redundancy, reliability and may be more cost-effective. In some cases, techniques can be combined to achieve zero, or close to zero, discharge (see Section 4.16.12).

Examples of combining techniques

There are several techniques that can be used to enable water to be re-used in processes and/or for the final cleaning of waste waters to meet low emission requirements, see Annexes 8.5 and 8.11.

Description

The final cleaning of waste waters by using chelating cation exchange resin is more efficient when carried out after effective metal removal. This can be by prevention and retention of raw materials (for example, see Sections 4.6 and 4.7), electrolytes (see Section 4.11.9) and/or precipitation (see Section 4.16.7). The efficiency of chelating cation exchange resin depends also on the effluent pH. The optimum pH is different for each metal. [121, France, 2003].

The removal of the metal (for example, with electrolysis,) may be most easily achieved at the rinsing stages (see Figure 4.20 Section 4.7), where it most concentrated and prior to mixing with any other contaminants. High efficiency electrolytic cells increase the lifetime of the exchange resin.

A combination of electrolysis and fluid bed technologies can be used on their own or in combination with semi-permeable membranes and ion-exchange technologies for the recovery of metals from polluted aqueous solutions, see Section 4.12.1 (some of these are proprietary and patented).

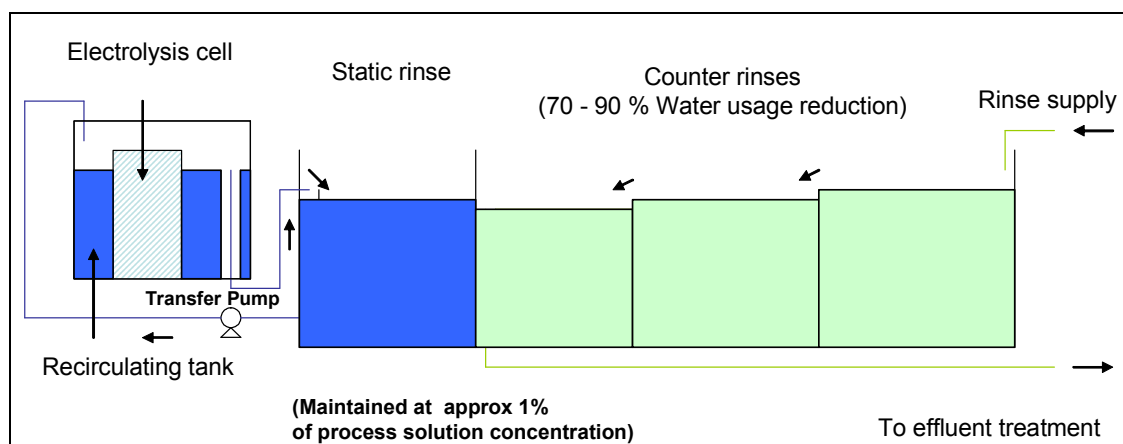

Figure 4.20: Removal of metal lost in rinsing prior to ion exchange Chemelec cell, BEWT Environmental Services Ltd.

Achieved environmental benefits

Achieving low levels of metal discharged.
Potential to re-use rinse-waters.

Ion exchange systems require space, not only for the resin columns but also for the regeneration plant. They also require sufficient expertise to control the regeneration and the produced water quality. For small installations, commercial systems operate where the resin columns are exchanged with a supplier who regenerates the resins at a central facility.

Cross-media effects

Power consumption, especially at low concentrations, unless a high efficiency cell is used.

Operational data

See Section

Applicability

Wide applicability on precious and non-precious metals.

Economics

There are several parameters that can have a significant effect on the capital cost but the central ones are the sustained flow through the ion-exchange and the level of metal contamination. Introducing metal recovery in the process line can remove 95 % of the metal transferred to the ion exchange resulting in a 2000 % increase in the time before the resin needs to be 'refreshed' (or alternatively the amount of resin and therefore the size and cost of the equipment can be reduced significantly):

- nominal capacity:
 - <1 m³/hr at 100 ppm GBP 25000 (June 2003)
 - <3 m³/hr at 100 ppm GBP 47000

Effluent treatment: The standalone units, which require minimal civil engineering works to install (i.e. pipe runs and level hard-standing) are modular in design and cater for a range of continuous flow of effluent from 0.5 to 9.0 cubic metres/hour of rinse solution. Capital costs vary dependant upon the number of stages of treatment prior to the final settlement tank and the level of process monitoring that has to be included and the method of off-site discharge. Operating costs are almost totally dependent upon the cost of the chemicals (acid, alkali, flocculent etc.) required for pretreatment.

- nominal capacity:
 - <0.5 m³/hr GBP 11000
 - <3 m³/hr GBP 23000
 - <9 m³/hr GBP 38000

Driving force for implementation

Water protection policy and legislation.

Example plants

For cadmium recovery and water re-use:

- South West Metal Finishing Ltd, Exeter, UK
- Moores (Wallisdown) Ltd., Bournemouth, UK.

For effluent treatment:

- C-TEC Ltd., Leighton Buzzard, UK
- Ekkato Ltd. (Aluminium Thrakis), 19 300 Athens, Greece.

Deioniser exchange is used by over 1500 installations in Germany.

Reference literature

[104, UBA, 2003, 110, BEWT, 2003], [12, PARCOM, 1992].

4.7.13 Zero discharge

In some cases techniques can be combined to the achieve zero discharges to water, See Section 4.16.12.

4.8 Other techniques to optimise raw material usage**4.8.1 Control of concentration of process chemicals****Description**

Process solutions become increasingly ineffective when the working concentration of certain process chemicals drops below specification. By topping up of the consumed process chemicals the service lifetime of a solution can be extended, see Section 4.1.2. SPC controls are often used and/or other production management systems A key problem remains that some production operators tendency to add more material than is necessary.

Where possible, automated dosing is the best option for accuracy and reliability, and allows regular additions and avoids swings in concentration. This may be actuated on a time, temperature, flowrate, or other control basis, such as pH or rH, etc.

Existing processes can be optimised by suppliers and/or in-house expertise to reduce the concentration of chemicals, particularly those with significant environmental or health effects.

There are two cases to differentiate between:

- Metals: the balance of the metal ions in electroplating is theoretically constant between the amount dissolved from the anode and the amount deposited at the cathode, but this is not true in practice, see Section 4.8.2. In the electroless deposition of a metal or with the use of inert anodes, the metal ions must be replaced in the solution according to their deposition rate and their drag-out.
- Process chemicals: the concentration of other remaining chemicals in the process solution, such as acids, alkalis, salts, gloss additives/brighteners or buffer substances is reduced automatically by drag out of electrolyte or by degradation in the process.

Achieved environmental benefits

Extension of service life of solutions.

Reduction in over-use of chemicals through uncontrolled additions.

Cross-media effects

None

Operational data

Measurement of key process solution components at preset intervals is necessary to monitor consumption, breakdown rates and additions made.

The consumption of the individual ingredients of the process solutions does not happen uniformly. Selected ingredients which are subject to a higher consumption need to be topped up separately. The selected dosage of components can be problematic where the individual material components are not known to the operator and not always available on the market. Chemical suppliers can assist with advising on control parameters and provide concentrates for topping up. The top up may have to be based on empirical investigations (operational experience) and can often only be automated with difficulty.

Applicability

All process solutions. The top-up of process chemicals to the original composition is general process technology and in practice found everywhere

Economics

Extends working life of most process solutions.

Improved process quality and consistency.

Driving force for implementation

See Economics, above. This is frequently required by customers.

Example plants

All sites visited; for example, SGI, Plaisir, France; Sikel N.V. Genk, Belgium; Corus, Llanelli, UK.

Reference literature

[18, Tempany, 2002, 104, UBA, 2003]

4.8.2 Different electrode yields

Description

The simple concept of electrolytic metal deposition is that the concentration of the metal ions in the solution remains constant because the metal anode dissolves at the same rate as deposition. However, in reality, there are frequently different electrode efficiencies at the anode and cathode. A higher anodic yield leads to an increase of the metal ion concentration. This can be found with certain electrolytes, such as nickel and zinc solutions.

There are options for dealing with this problem, which may be used alone or together. Problems are discussed under Applicability, below:

- where solution electrochemistry allows, use insoluble anodes with external dissolution of the metal and controlled solution strength (see introduction to Chapter 2, Electrolytic cells and reactions)
- replace some of the soluble anodes by membrane anodes with an extra current circuit
- special insoluble anodes that allow the concentration of the solution to be balanced
- run workpieces or substrates requiring higher thickness coatings
- 'plating out' on steel sheet
- removing anodes.

Achieved environmental benefits

Minimisation of energy usage and waste of process metal in drag-over.

Reduction of plating over the required specification thickness.

Reduction in environmental effects from reworking due to problems with over-plating.

Cross-media effects

Additional equipment is required where external dissolution tanks are used, or membrane circuits and/or separately controlled additional circuits.

Operational data

All techniques may improve process control, but see Applicability. Use of external make-up tanks or process additions requires increased process quality control and maintenance.

Applicability

Many electrolytic processes, including zinc, can utilise insoluble electrodes and use external make-up tanks, or separate solution additions. An inert anode system with external make up requires additional investment but addresses the problem consistently over time.

Running workpieces or substrates requiring higher thickness coatings and 'plating out' on steel sheet, only works with soluble anodes. 'Current efficiency' may then become too high. The right balance of specifications for workpieces (i.e. combination of thicker and thinner coating thickness requirements) may not coincide with the need to remove excess dissolved metal, especially for jobbing shops.

Removing anodes: the anodic current density must be considered. This can lead to anode passivation and/or increased electrolytic decomposition of process solution constituents. The reduced current density reduces throughput and takes more time to reduce the process solution metal concentration.

Plating out does not recover anode metal. However, electrolytic selective plating using low current densities can be used to remove unwanted contaminating metals, for example from nickel baths with soluble Ni anodes.

In practice, nickel processes cannot utilise insoluble electrodes (see Section 2.5.2)

Membrane anodes are breakable, and it may not be possible to use this technique in sub-contract plating, where the shapes and sizes of parts to be plated vary continuously (and may make contact with and break membranes). Membrane anodes are also limited by current density.

Economics

Investment in an inert anode system with external make-up or using membrane anodes with a separate circuit is usually self-financing through materials saving and improved process quality. Other options are cheaper in the short term, but lack long-term consistency and savings, and if relied on regularly, may give more quality problems (and hence cost) than they resolve.

Driving force for implementation

Process economics.

Process uniformity over time and reduction in reworking.

Example plants

Metal Colours, Slough, UK.; SIKEL N.V. Genk, Belgium.

Reference literature

[18, Tempany, 2002](verbal discussions with TWG members) [60, Hemsley, 2003, 73, BSTSA,]. [119, Eurofer, 2003] [73, BSTSA,], [113, Austria, 2003, 165, Tempany, 2004]

4.8.3 Switching the polarisation of the electrodes in the electrolytic processes

Description

The polarisation of electrodes in electrolytic degreasing and in electrolytic pickling processes is switched at regular time intervals.

Achieved environmental benefits

Reduction of raw material consumption as the plating efficiency is higher.

Cross-media effects

None.

Applicability

New and existing coil coating plants with bipolar electrodes.

For jig and barrel plants, the solutions become contaminated by the substrate metals and would require two tanks.

Where the substrate is suitable, e.g. hydrogen production may occur.

Economics

For coil coating, the initial investment is EUR 0.015 to 0.8/t to EUR >0.8/t installed, with maintenance costs of EUR 0.001 to 0.15/t.

Driving force for implementation

Process efficiency and product quality.

Example plants

Many continuous coil electroplating lines.

Reference literature

[19, Eurofer, 2003]

4.9 Substitution – choice of raw materials and processes

General description

Surface treatment uses a wide range of chemicals in a wide range of processes. Section 1.4.4. Annex IV of the Directive requires the use of less hazardous substances to be considered [1, EC, 1996] and it is also a PARCOM recommendation. However, there may be other environmental benefits to be gained, either in conjunction with using less harmful substances, or for the other gains in their own right, e.g.:

- lower materials usage, both in process, in waste water and air emission treatment
- energy saving
- water saving

There are also other operational and economic reasons for substitution, e.g.:

- improved quality and reliability of the process
- costs savings for decreased waste water treatment
- cost savings for reducing air extraction and treatment
- health and safety in the workplace.

Substitution can be achieved by:

- substitution directly of one substance by a less harmful one. An example is the replacement of EDTA or NTA with derivatives of gluconic acid. There are limited opportunities for this in surface treatment
- substitution by different process chemistries or methods. This is used where there is no direct replacement, for example, replacement of zinc cyanide by cyanide-free alkali or zinc acid solutions. Different coating process chemistries give treatments with different properties, even for the same materials
- substitution by different surface treatments, such as substituting autocatalytic nickel or vapour deposition of chromium for hard chromium plating. If the substitution is for the core treatment, the final properties may be different.

Some key issues are discussed as substances, e.g. hexavalent chromium, and options include substitution of chemicals and processes. Others issues are discussed as process types, such as degreasing.

Overall achieved environmental benefits

Reduction in the use of harmful substances and the amounts subsequently entering the environment.

Other improvements in environmental performance, such as energy saving, production of less waste, emission of less noise or dust, etc.

Overall cross-media effects

These effects depend on the individual alternative technique. Some may have effects such as increased energy usage (vapour deposition techniques), increased waste production (acid zinc) or increased water or raw material consumption.

Failure to meet specific requirements (see Overall applicability, below) will lead to increased rejects and reworking, with consequent environmental impacts (see Section 4.1.2).

Overall operational data

See individual examples from Sections 4.9.1 to 4.9.16.

Overall applicability

In all cases, it is essential to discuss the changes with the customer in advance of making the substitution. It is good practice not to make changes without full knowledge of the final performance characteristics required. Failure to meet these characteristics, particularly without warning, can lead to loss of customer confidence and increased rejects. To ensure processes operate to the required standard, it is advisable for both operator and customer to monitor quality and performance to, and exchange information on, the required specification (see Section 4.1.2).

Economics

This will be on a case by case basis. In some cases, there will be economic incentives from energy saving, etc.

Driving force for implementation

Health and safety of employees is a major driver for substituting less harmful substances, e.g. substituting for hexavalent chromium.

Other environmental legislation, such water legislation driven by OPSAR and PARCOM recommendations, the Water Framework, Seveso II, and Solvent Emissions Directives. Substitutes may be more cost effective.

Example plants

SGI, Plaisir, France; Sikel N.V., Genk, Belgium.

Reference literature

[11, Tempany, 2002, 18, Tempany, 2002](verbal discussions with TWG members industry at site meetings)[60, Hemsley, 2003] [12, PARCOM, 1992] [124, Germany, 2003]

4.9.1 Substitution for EDTA and other strong complexing agents (chelating agents)

Description

The problems of strong chelating agents particularly EDTA are described in Section 1.4.4.5. They are widely used in process solutions such as degreasing and etchants used for printed circuit board manufacture. They may be replaced by weaker and biodegradable ones, such as those based on gluconic acid. There are alternatives used in pickling and cleaning in Germany. EDTA is also used to some extent in electroless copper in PCB manufacturing. However, there are many alternatives to substitute EDTA, including so-called direct plating methods (for example tartrate-complex in copper solution), see Section 2.11.2.4.

Achieved environmental benefits

Reduction in solubilisation of metals in waste water treatment systems and in environment systems.

Cross-media effects

Substituting or reducing the amount of EDTA released reduces the energy and chemicals required for destruction.

Operational data

EDTA can also be destroyed or eliminated, see Section 4.16.8

Applicability

Printed circuit board manufacture: specifications for the latest technology may require the return to using EDTA.

Reference literature

[3, CETS, 2002, 12, PARCOM, 1992, 22, Fraunhofer, 2002] [124, Germany, 2003] [120, Finland, 2003]

4.9.2 Substitution for, and reduction of, toxic surfactants (NPE and PFOS)

Description

There are two families of problem materials that are toxic and bio-accumulative:

- NPE and nonylphenol are OSPAR chemicals for priority action and are banned for metal working, with effect from 17 January 2005, except for uses in “*controlled systems where the washing liquid is recycled or incinerated*”
- PFOS (Perfluorooctane sulphonate) is widely used as a foam suppressant and surfactant, especially in preventing the formation of mists in hexavalent chromium electroplating and alkali non-cyanide baths. However, it is now under investigation (see Annex 8.2) and the OECD Task Force on Existing Chemicals has already agreed that it is persistent, bio-accumulative and toxic.

No substitutes for NPE have been reported.

Substitutes are available and in use for anodising.

There are currently no substitutes for PFOS in Cr(VI) plating and pickling because of its strong resistance to oxidation. PFOS is also used in alkali cyanide-free zinc processes to reduce spray, as well as zinc alloy plating, some anodising and strong acid gold processes.

Achieved environmental benefits

Substitution by less harmful substances, or alternative processes will reduce the environmental and health effects.

Cross-media effects

PFOS has important health and safety functions in controlling the spray from harmful solutions. Increased extraction of Cr(VI) and other air pollutants due to cessation of use may require additional scrubbing and treatment.

Operational data

In situations where PFOS has been used, such as Cr(VI) plating, other measures may be taken to prevent Cr(VI) mist reaching MAC levels in the workplace, such as use of floating insulation (see Section 4.4.3), lids on tanks and/or redesigned and/or upgraded ventilation (see Section 4.18.2), substitution by a less harmful process (see the appropriate parts of this section), etc.

If PFOS has to be used, then it is best practice to use it in a closed loop process. Cr(VI) plating can be run on this basis.

Other processes can be run with drag-out reduction and rinsing techniques to conserve PFOS in the process tanks, see Sections 4.6 and 4.7

Applicability

Cr(VI) plating can be run on a closed loop system. Other processes can utilise drag-out and rinsing techniques to minimise the release of PFOS. Its use can also be minimised by controlling the addition of PFOS (or solutions containing PFOS) using surface tension measurements.

Originally, it was reported that no PFOS is used in France, but other reports suggest it is in use.

Economics

Cost of additional air extraction or control equipment.

Control measures, such as surface tension measurements, are minimal.

Drag-out measures also retain other materials.

Driving force for implementation

Occupational health legislation. For NPE, a ban is now in place

Example plants

Reference literature

[73, BSTSA,] [30, EC, 2003] [109, DEFRA, 2004, 165, Tempany, 2004]

4.9.3 Substitution for cyanide – overview

Overall description

Cyanide has been widely used in many electrolytic processes such as zinc, copper, cadmium, silver and gold plating. It is also extensively used in other surface treatment processes, such as degreasing processes and nickel stripping.

Processes with alternatives to cyanide are discussed in Sections 4.9.4 and 4.9.5.

Overall achieved environmental benefits

Reduction of use and emission of cyanide.

Reduction of AOX: AOX may be generated through chemical oxidation of cyanide in waste water treatment with sodium hypochlorite and chlorine.

Cyanide electrochemical baths have low current efficiency compared with acid zinc (70 - 85 % efficient), see Section 2.5.4.

The plating baths for cyanide-free plating of copper on iron and steel have a phosphonate complexing agent, which can only be removed by precipitation with lime. This leads to more waste produced when compared to cyanide plating.

Cyanide-free copper also needs twice the current than cyanide copper because of the two oxidation states of cyanide-free processes.

Overall cross-media effects

See specific applications for data on each application.

Overall operational data

Free cyanide is easy to manage and treat.

See specific applications for data on each application.

Applicability

There is no single chemical substitute for cyanide.

There is no successful substitute (chemical or process) for cyanide in the treatment of substrates such as zinc die-cast, magnesium die-cast and others. Zinc die-cast products are widely used in bathroom fittings, furniture, automotive and telecommunication products. A stable working substitute process is not known for serial, high volume production lines.

Other factors affecting substitution for cyanide are:

- poorer degreasing ability of cyanide-free electrolytic degreasing electrolyte (cyanide solutions have inherently good cleaning properties and are tolerant of indifferent pre-cleaning)
- increased maintenance and skill level required for alternative processes (bath control, bath analysis, etc.)
- modification of the coating characteristics.

Economics

There may be increased costs with running non-cyanide systems. However, these may be offset by reduced effluent treatment.

Driving force for implementation

Decreased health and safety risk.
Public perception of the use of cyanide.
Improved compliance with environmental quality standards.
Decrease in the risk of environmental accidents.

Example plants

Metal Colours Ltd, Slough, UK; SIKEL N.V. Genk, Belgium.

Reference literature

[3, CETS, 2002, 18, Tempany, 2002, 124, Germany, 2003] [113, Austria, 2003]

4.9.4 Zinc electroplating

Zinc electroplating has been one of the major uses for cyanide in the sector.

4.9.4.1 Alkaline cyanide zinc**Description**

See Section 2.5.4.

Achieved environmental benefits

Cyanide can be readily oxidised in waste water treatment plants

Cross-media effects

Requires waste water treatment.
May require fume extraction.
Poor process efficiency of 50 % power input, decreasing with current density.

Operational data

Does not require high standard degreasing because of self-cleaning capability
Easy to operate and maintain.
Has a lower consumption of brighteners Requires more space.
Highly suitable for barrel plating. Achieves guaranteed layer thickness on jig and barrel processing and has good throwing power into holes and blind spaces

Applicability

Ductile deposit with good throwing power.

Reference literature

[114, Belgium, 2003, 124, Germany, 2003].

4.9.4.2 Alkaline cyanide-free zinc**Description**

See Section 2.5.4.

Achieved environmental benefits

No cyanide used.
Reduced waste water treatment requirements.

Cross-media effects

With higher voltage because of insoluble anodes and poor current efficiency of 50 – 70 % decreasing with increasing current density, the process is at least twice as energy intensive as other Zn processes. With potassium electrolytes, the current efficiency can be increased to 70 %. 70 – 85 % is achievable at 2 A/m² for well managed processes. See Section 2.5.4.

With poor current efficiency, more (possibly twice) the process capacity is needed compared with acid zinc systems.

Alkaline zinc needs more air extraction than the other Zn processes. It can be optimised by using wetting agents, which provide a foam covering to the bath. A further option is to cover the tank where the zinc is chemically dissolved externally to the solution, although the foam suppressant may contain PFOS (see Section 4.9.2 and Annex 8.2).

Operational data

Needs to be preceded by high quality degreasing systems.

Needs skilled process control and management.

Dispersion of coating thickness is better than cyanide processes.

Applicability

Better metal distribution than cyanide processes.

Driving force for implementation

See Section 4.9.3, Overall driving forces for implementation.

Reference literature

[3, CETS, 2002, 18, Tempany, 2002, 124, Germany, 2003] [113, Austria, 2003] [129, Spain, 2003, CETS, 2003 #115]

4.9.4.3 Acid zinc

Description

See Section 2.5.4.

Achieved environmental benefits

High current efficiency, approaching 95 %.

No cyanide used.

Reduced waste water treatment requirements.

No special requirement for fume extraction.

Cross-media effects

Increased sludge production, from dissolution of some of steel substrates and with soluble anodes.

May require fume extraction for acid mists, but not necessary for chloride-based solutions. However, extraction is advisable.

Operational data

Needs to be preceded by high quality degreasing systems.

Needs skilled process control and management.

Soluble and insoluble anodes can be used instead of only soluble ones, giving better quality control, see Section 4.8.2

Applicability

The metal distribution is poor to acceptable, increasing with warm electrolytes.

Economics

Large savings in power consumption.

Driving force for implementation

See Section 4.9.3, Overall driving forces for implementation.

Example plants

Metal Colours Ltd, Slough, UK; Sikel N.V. Genk, Belgium.

Reference literature

[18, Tempany, 2002] [119, Eurofer, 2003]

4.9.4.4 Zinc alloys

Zinc alloys are widely used and well-established, but no data has been provided on their use as substitutes for zinc processes.

4.9.5 Other cyanide - based solutions

More detail is given on these in the relevant sections in Chapter 2.

Chapter 2 description	Process or chemical	Chapter 4 Reference
2.3 Workpiece or substrate preparation		
	Cyanide degreasing	Thought to be obsolete [112, Assogalvanica, 2003]
2.5	Core activities - plating	
2.5.1	Copper and copper alloy plating	Copper cyanide is necessary for strike plating on steel and zinc die casts, and some barrel plating. Acid copper is the solution of choice in Germany. Pyrophosphate copper has limited applications. No alternatives to cyanide solutions for brass and bronze are reported.
	Copper cyanide	
	Acid copper	
	Pyrophosphate copper	
	Brass	
	Bronze	
2.5.4	Zinc and zinc alloy plating	See Section 4.9.4.
	Alkali cyanide zinc	
	Alkali cyanide free zinc	
	Acid zinc	
	Zinc alloys	
2.5.5	Cadmium plating Electrolytes may be based on cyanide, fluoroborate, sulphate or chloride For most other applications acceptable alternatives have been developed. Acid zinc plating lowers the risk for hydrogen embrittlement and tin can replace cadmium for giving a low and constant friction coefficient on fasteners. Mechanical zinc plating and zinc/aluminium flake coatings can also be viable alternatives for protecting high strength steels. [115, CETS, 2003]	
2.5.7	Precious metal plating	
	Silver	
	Gold	

Table 4.9 Process solutions using cyanide

4.9.6 Substitution for, and minimisation of, hexavalent chromium

Introduction

Hexavalent chromium chemicals, such as chromic acid, are frequently used in surface finishing. The main applications are:

- decorative chromium plating
- hard chromium plating
- chromic acid anodising
- chromate conversion coatings.

See Annex 8.1 for details of chromium and its compounds in relevant legislation and agreements. Hexavalent chromium has been classified as carcinogenic by inhalation, and regulations apply to its use in processes. It is a priority substance for the US EPA to minimise use and release [148, HTMLA, 2003] [108, NEWMOA, 2003], as well as restrictions on the use of hexavalent chromium products [144, EC, 1976]. Chromium trioxide is being reviewed by the EU and is likely to be raised in status from toxic to very toxic. This may trigger the lower threshold requirements of the Seveso II Directive where over five tonnes are used [142, EC, 1996].

The health and environmental issues associated with hexavalent chromium are described in Section 1.4.4.1. In addition, only chromate films containing hexavalent chromium may release Cr(VI) during the handling and the usage of the finished product. There are no contact problems with metallic chromium on finished workpieces from any process (hexavalent or a trivalent) [124, Germany, 2003].

Any zinc-plated part is usually post-treated with a suitable chromate conversion process as well as many substrates (such as die-castings). The colour of the finishes of existing hexavalent chromium conversion processes and the level of their corrosion protection is directly in relation to their thickness and to their hexavalent chromium content.

Because of these environmental and health and safety concerns, European directives limit the amount of hexavalent chromium left in the product in the automotive, electrical and electronic industries [96, EC, 2003, 98, EC, 2003, 99, EC, 2000]. This is the driving force for innovative hexavalent chromium-free technologies. Various EU R&D projects are nearing conclusions on Cr(VI) management, [28, DG-RTD, 2002].

4.9.7 Minimisation of release of hexavalent chromium from treated surfaces

Description

Topcoatings for chromium passivation systems are described in Section 2.5.17. or they can be provided by powder coating or any other topcoat. From Table 4.10, it can be seen that an application of a suitable topcoating layer on the chromate conversion coating is sufficient to dramatically reduce release of chromium VI.

The chromium VI release is also a function of the quality and amount of the rinsing following the post-treatment: rinses have to be designed to avoid any residue of the chromate conversion solution remain adsorbed on the surface of the treated parts. However, the corrosion protection of the more intense colours (yellow to black) can be severely diminished by excessive leaching from rinsing.

Table 4.10 shows the releases of Cr(VI) from different coloured passivations, based on several statistical industrial determinations.

Electroplated coating	Chromate conversion coating Finish colour process type	Cr(VI) release
Zinc and zinc alloys [124, Germany, 2003]	Clear-blue Cr(VI)	0.05 – 0.1 µg/cm ²
	Clear-blue Cr(III)	0.0 µg/cm ²
	Yellow-Tropical Cr(VI)	0.3 – 0.6 µg/cm ²
	Green Cr(VI)	0.7 – 0.9 µg/cm ²
	Black Cr(VI)	0.7 – 1.0 µg/cm ²
	Yellow-Tropical Cr(VI) Followed by a topcoat layer	0.1 – 0.2 µg/cm ²
	Black Cr(VI) Followed by a topcoat layer	0.02 – 0.1 µg/cm ²

Table 4.10: Release of chromium (VI) from treated substrate

Achieved environmental benefits

Reduced hexavalent chromium releases in subsequent handling and use.

Driving force for implementation

Increasing health and safety concerns for the use of Cr(VI) and various directives limiting its use.

Example plants

Reference literature

[124, Germany, 2003] [96, EC, 2003, 98, EC, 2003, 99, EC, 2000] [3, CETS, 2002] [118, ESTAL, 2003].

4.9.8 Chromium electroplating techniques

There are several options commercially available. Hexavalent chromium is the most widely used, but concern about its toxicity and use are increasing. The most widely-used alternative is trivalent chromium. There has been a significant information exchange and validation of this issue by the technical working group The comments [146, ZVO, 2003, CETS, 2004 #147] and discussion are in Annex 8.10.

4.9.8.1 Hexavalent chromium plating

Description

See Section 2.5.3.

Achieved environmental benefits

Waste water s can be treated in a typical waste water treatment plant. Because of poor current efficiency and the need to cool the solution, it can be run as a closed loop system, using multistage cascade rinsing and evaporation.

Cross-media effects

Very toxic to health in the workplace and the environment (see Section 4.9.6).

Treatment requires additional hazardous chemicals.

High solution concentrations have high viscosity and drag-out levels.

Air extraction requires scrubbing to remove the aerosol of Cr(VI).

High waste production from lead anodes.

Cr(VI) compounds are strong oxidising agents and it is advisable to store them separately. Dried Cr(VI) electrolytes have been known to cause fires

Operational data

Poor electrical efficiency caused by hydrogen evolution at the cathode (up to 85 - 90 % of power consumption) and the solution requires cooling.

Hydrogen evolution causes a mist of Cr(VI) which, with handling of the solution and components, creates high profile workplace occupational health problems.

Mist suppression additives can be used, but these are based on PFOS, which has health and environmental risks (see Section 4.9.2).

Poor metal distribution and sensitivity to ripples in the power supply cause relatively high reject rates.

Self-passivation of unplated areas assists corrosion resistance.

Applicability

Widely applied in nearly 3000 installations worldwide.

Hard or functional chromium for engineering purposes can only be applied by this technique (but for an emerging alternative technique, see Section 6.2).

Economics

Solution costs are cheap.

High energy costs for power consumption, higher reject rates and waste water treatment plant costs.

Increasing insurance costs to cover health and safety of workforce have been reported.

Driving force for implementation

Only large scale techniques for hard chromium plating, and some higher specification decorative finishes. Self-passivating in unplated areas.

Example plants

Widely applied in nearly 3000 installations worldwide.
Closed loop operation (with preceding closed loop nickel and copper) in Merrydale Industries Ltd, Wednesbury, UK.

Reference literature

[108, NEWMOA, 2003, 147, CETS, 2004] [125, Ireland, 2003, 147, CETS, 2004]

4.9.8.2 'Cold chromium' – hexavalent process**Description**

A new technique using 'cold chromium' has been put into production in 2000 in an Italian plant. The temperature of the processing bath with Cr(VI) is kept at about 18 – 19 °C by a refrigeration system (instead of 25 – 30 °C). At this temperature, the concentration of Cr(VI) in the process solution may be reduced by about 50 %. The quality of plating is the same.

Achieved environmental benefits

Minimisation of hexavalent chromium released.
Minimisation of evaporation of process solution evaporation.
Less energy used in the process.
Reduction of exposure to workers.
Reduction of water consumption.
Less waste water treatment required and less sludge produced.

Cross-media effects

Additional energy required for refrigeration. It is not clear how this compares with the energy savings in the process.

Operational data

Less concentrated solutions require a longer time for processing.
Better quality because of better throwing power.
No white edges.

Applicability

The technique may only be suitable for application in a new plant.

Driving forces for implementation

As introduction to Section 4.9.

Example plants

Industria Galvanica Dalla Torre Ermanno e Figli SpA, Fontane di Villorba, Italy.

Reference literature

[112, Assogalvanica, 2003]

4.9.8.3 Trivalent chromium chloride-based electroplating process

Description

See Section 2.5.3

Achieved environmental benefits

The plating bath runs at a concentration of 20 g/l instead of 200 to 450g/l for hexavalent chromium. Reduced solution viscosity means less chromium dragged-out, and a reduction of chromium released: Cr(VI) is not released. Solutions can be chloride- or sulphate-based.

In three case studies, the following were found:

- reduced or no hexavalent chromium compounds to store, handle or were in use
- in conjunction with electrolytic removal of chromium (as hydroxide), waste water treatment sludge reduced from 20 tonnes per year to 2 tonnes per year in one case, and there was thirty times less sludge in another
- about 30 % reduced power consumption
- no chemicals required for metals reduction
- no surfactants required to prevent mist formation
- the plating baths can be recovered using porous pots, membrane electrolysis or ion exchange
- air pollution treatment requirements reduced.

Lower health and environmental problems for Cr(III), reflected in TA-Luft values of 1 mg/m³ for Cr(III) to 0.05 mg/m³ for Cr(VI).

Cross-media effects

Problems have been reported in waste water treatment plant caused by complexing agents used in Cr (III) solutions. However, these have not been confirmed on site visits or in the case studies.

Operational data

The colour of the Cr(VI) deposit is described as blue-bright, the chloride trivalent deposit varying as grey-bright, yellow-bright or dark-bright. These historic problems with colour differences to deposits from hexavalent chromium and variations during processing compared with hexavalent chromium have largely been overcome by new solutions. These colour problems, and poor solution reliability and life, have long been overcome: it is crucial to use carbon filtration and ion exchange, or proprietary solution treatment processes, as well as minimising carry-over from previous processes.

Trivalent chromium solutions containing chloride can theoretically produce chlorine at the anode and hence AOX in the solutions, which could be dragged-out. In practice this has been controlled for 20 years by the addition of proprietary chemicals.

Requires training of staff and increased process control, which is similar to that required for bright nickel, which is used for the preceding layers.

Thicknesses can be measured by the same equipment (e.g. Couloscope, X-ray diffraction).

Higher current efficiency means higher loading of racks and 15 % increase in throughput has been reported.

Lower current density requires lighter, less expensive racks and wiring.

Reject rate reduced from 5 - 10 % to 0.5 % due to Cr(III)'s better throwing power, higher current capacity and less susceptibility to ripples in supply, reducing rough deposits (i.e. burning in high current density areas) and reduced 'whitewashing' from plating interruption.

Applicability

It cannot replace hard chromium plating.

It cannot replace certain corrosion resistance applications, such as where the CASS requirement is greater than 16 h. Trivalent chromium does not passivate unplated surfaces. Lower corrosion resistance has been reported, which is likely to be due to areas of no or low nickel thickness. Where hollow or recessed components (such as tubes) are plated, care is needed to prevent corrosion post-plating. This includes rapid and thorough rinsing of the acid bath, and possibly followed by passivation in a proprietary organic solution (validation from industry practitioners internationally) or a light Cr(VI) passivation (this mitigates some of the advantages of a Cr(VI)-free system).

The colour is a slightly yellow hue when compared directly to parts plated by hexavalent chromium. Cases have been reported of this being a problem to specific customers.

Colour and corrosion resistance has been accepted in major retail uses, such as cookers, on components subject to high temperatures and abrasive cleaners with strong caustic and acid components.

This has successfully been used with no loss of customer confidence (see Section 4.1.2).

Economics

One-off costs include disposal of old hexavalent chromium solution, replacing lead vat lining with PVDF and replacing lead/antimony anodes with carbon. An ion exchange system is required for controlling metal contamination, and the resin requires changing at approximately three year intervals. The base chemicals are more expensive.

These are more than offset by:

- a 30 % saving in energy
- a reduction in solid waste produced and disposed of
- reduced effluent treatment costs (no Cr(VI) to reduce)
- reduced air monitoring
- reduced staff medical monitoring
- reduced reject rate
- a significantly reduced risk of employee ill health.

One case study reports an overall gross profit improvement of USD 182 per shift of 670 m² from a jig plating line (1995 costs).

Driving force for implementation

Reduced risk to employee health. Reduces health and safety requirements, as well as expenditure on aerosol suppression, air extraction, monitoring for hexavalent chromium in the workplace atmosphere, as well as medical monitoring of staff. Cost-effective overall.

Example plants

Townrow (Hi-Tech Plating) Ltd, Sheffield, UK (case study), Foss Plating, Santa Fe Springs, California.

Reference literature

[43, SEA, 2001] [108, NEWMOA, 2003, 115, CETS, 2003, 148, HTMLA, 2003]

4.9.8.4 Trivalent chromium sulphate electroplating process

Description

For decorative nickel-chromium process. The process is carried out using sulphate electrolyte with Cr (metal) concentration between 6 and 8 g/l.

Achieved environmental benefits

Reduced Cr concentration when compared with trivalent chromium chloride (up to 20 g/l) and with hexavalent chromium (up to 450 g/l) processes.

No complexing agents (unlike chloride process) that may give rise to problems in the waste water treatment plant.

In addition to the environmental benefits achieved with chromium chloride solutions this process is more safe because there is no production of chlorine at the anode.

The solution is less aggressive and last longer. The problem of iron dissolution in the inner, hollow parts of workpieces is dramatically reduced.

Reduced drag-out thanks to the low viscosity of the solution.

Cross-media effects

No data available.

Operational data

Special insoluble anodes are used. They last much longer than graphite anodes used for trivalent chromium chloride solution (chlorine corrodes graphite anodes).

The bath is operated at 55 °C. Evaporation reduces the level of solution in the vat and therefore the addition of recovered solution is made possible. When slowly withdrawn workpieces are rather dry and drag-out is reduced.

The colour difference to hexavalent chromium coating is further reduced when compared with the colour of coatings deposited from chloride solution.

Throwing power is excellent: it increases the overall resistance to corrosion and in particular of those places usually never reached even by Cr(VI) coating and where rust will first crop out. In addition, no “burning” like patch forms when the intensity of current is high.

Applicability

The technique may apply to new and existing plants.

Economics

No data available.

The components of the solution are very expensive when compared with those of Cr(VI). These costs are only partially offset by the lower costs of waste water treatment and the smaller amount of sludge produced. However, other costs are also lower (see Cr(III) chloride case studies).

Driving forces for implementation

As for chromium (III) chloride process, see Section 4.9.8.3.

Example plants

Industria Galvanica Dalla Torre Ermanno e Figli SpA, Fontane di Villorba, Italy. About 12 more lines in Italy.

Reference literature

[161, Assogalvanica, 2004]

4.9.9 Chromium free processes – other coating processes

Options are given in Table 4.11, below.

Other hard chromium plating substitutes such as nickel-tungsten-silicon carbide composite are still in the research phase. For specific applications, an alternative could be an electroless nickel coating [3, CETS, 2002]. Nickel - tungsten is only used in brush plating in applications [113, Austria, 2003].

Hard chromium can be replaced in some applications by alloyed WC-Ni(Co)Cr/Cr₂O₃, or by high velocity oxy-fuel spraying or plasma spraying [121, France, 2003].

Possible Non-chromium replacement		Comments
Electroplated nickel	Nickel-tungsten-boron	Uses conventional plating equipment and operates similarly to a conventional nickel plating bath; may be more costly than Cr(VI)
	Nickel-tungsten-silicon-carbide	May provide higher plating rates and higher cathode current efficiencies; may provide better throwing power and better wear resistance; may be more costly than Cr(VI)
	Tin-nickel	Good corrosion resistance in strong acids, breaks down above 320 °C, less wear resistance than Cr(VI)
	Nickel-iron-cobalt	Vendor claims twice the wear resistance and 2.6 times the corrosion resistance of hex chrome; same colour can be obtained
	Nickel-tungsten-cobalt	Contains no chloride or strong chelators; can be used in rack and barrel plating; good corrosion resistance except in marine environments; may tarnish; contains ammonia
Non-nickel electroplate	Tin-cobalt	Three commercial options reported, with different attributes: <ul style="list-style-type: none"> • plate on nickel; decorative only • plate on decorative nickel and nickel alloy; may be used in racking; mildly alkaline • good colour, light blue cast; no ammonia; no fluorides; no chlorides
	Cobalt phosphorous	Nano-crystalline deposit produces extreme hardness; plating current waveform modification (electrically mediated deposition) used to produce nano-crystalline deposit.
Electroless	Electroless nickel: -nickel-tungsten -nickel-boron -nickel-diamond composite -nickel-phosphorous -nickel-polytetrafluoroethylene	Possibly less hardness and abrasion resistance than Cr(VI); no build up on corners
Other methods	HVOF (high velocity oxygenated fuel) thermal sprays	Hardness and wear resistance similar to Cr(VI); limited to line-of-sight applications.
	Physical vapour deposition (PVD) -titanium nitride	Greater hardness than Cr(VI) with a thinner coating; less corrosion resistance
	Ion beam-assisted PVD	Line-of-sight; thinner coatings give same properties as other thicker coatings
	Plasma spray -titanium carbide	Aluminium, steel, carbon steel, titanium substrates
	Chemical vapour deposition	Vacuum deposition; not limited to line-of-sight; resistant to acids; high deposition rate
	Ion implantation	Ions are implanted – no thickness; non-line-of-sight
	Powder coating	Vacuum metallisation (PVD) – has met OEM wheel industry testing requirements including ASTM B117, GM4472P, GM9508P, GM9682P, and GM6
	Laser cladding	Non-line-of-sight; nickel carbide coating

Table 4.11: Summary of non-chromium substitutes for hard and decorative chromium baths
North East Waste Management Officers' Association, US [108, NEWMOA, 2003]Tin cobalt alloy electroplating

Description

A chromeless technique using Sn/Co alloy (Co 5 – 10 %) has been tested and run in production lines for several years in Italian installations and in the Netherlands. This technique has a high penetration capacity (it can plate more complex shapes than hexavalent chromium) and provides top quality finishing. The finishing colour may be slightly darker than that obtained with Cr(VI).

Achieved environmental benefits

Minimisation of hexavalent chromium.
Treatment of rinsing water is easy and effective.

Cross-media effects

Some tin-cobalt baths contain chelating amines which cause problems with waste water treatment. However, this does not apply to all solutions.

Operational data

The bath is rather unstable, a strict control of the operative conditions is required, in particular the pH.

A passivation stage with light Cr(VI) may be needed.

Barrels need to be made of acrylic.

Applicability

It has been approved for certain automotive interior parts since the 1990s by General Motors.

It does not have high wear resistance.

Economics

No data available

Driving forces for implementation

As introduction to Section 4.9.

Example plants

Cromotrevigiana Srl, Ponzano Veneto, Italy. Industria Galvanica Dalla Torre Ermanno e Figli SpA, Fontane di Villorba, Italy. Brandsma Metaalveredeling B.V., Hilversum The Netherlands.

Reference literature

[112, Assogalvanica, 2003] [165, Tempany, 2004] (Personal communication, Hank de Man, Brandsma Metaalveredeling BV.)

4.9.10 Chromium conversion coatings

The processes are widely used and described in Section 2.5.17. Due to the driving force of the ELV and ROHS Directives [98, EC, 2003, 99, EC, 2000], a large amount of work is being undertaken worldwide to develop alternatives to Cr(VI). Improvements and options are steadily being reported. Some reports indicate the future lies with alternative substrates, or alternative coating systems, such as replacing zinc plating with zinc alloys [149, PPT, 2004, 150, Rowan, 2003].

Phosphochromating exists with both hexavalent chromium (Cr(VI)) and trivalent chromium (Cr(III)) versions and is used in the treatment of aluminium prior to painting [90, EIPPCB,] [118, ESTAL, 2003].

4.9.10.1 Hexavalent chromium

Description

A widely used technique, often in conjunction with zinc plating, as discussed in Section 2.5.17.

Used in passivating copper, brass and bronze in preference to bright dipping, as fewer fumes are evolved. It is also used for magnesium and its alloys.

It is widely used prior to power coating, although low Cr(VI) solutions are available, as well as the alternatives described in Sections 4.9.10.2 and 4.9.10.3

Achieved environmental benefits

Low Cr(VI) solutions reduce negative impacts.

Cr(VI) solutions run at lower concentrations and lower temperatures than some of the alternatives.

Cr(VI) can readily be reduced and precipitated in a typical waste water treatment plant.

Operational data

Easy to use.

Applicability

Economics

Very cheap.

Driving force for implementation

Cost, ease of use and corrosion resistance.

4.9.10.2 Trivalent chromium conversion processes

Description

Trivalent chromium passivation is described in Section 2.5.17. The protection mechanism of the trivalent chromium conversion coatings is not yet fully understood. Their behaviour seems to indicate that the protection is mainly due to the physical barrier of the coating itself, since the coating is not sensible to any subsequent thermal shock. As can be seen from Table 4.10, there is no release of trivalent chromium from workpieces where it is used.

In some cases at least, the action of the Cr(III) is catalysed or assisted by other metals, such as cobalt

Certain Cr(III)-based conversion coatings have a higher performance and can match normal Cr(VI) conversion coatings when used with alloy plating and/or with additional coatings, see Sections 2.5.11, 2.5.17 and for emerging techniques, Section 6.3.

Achieved environmental benefits

No hexavalent chromium use and releases.

Cross-media effects

May involve the use and release of other metals such as cobalt.

Runs at ten times the concentration of Cr(VI) conversion layers, requiring more attention to minimisation of drag-out and possibly more waste water treatment.

Requires heated solutions with more energy input.

Applicability

The corrosion protection achievable with these processes is currently limited to the protection level provided by the equivalent clear blue and yellow iridescent finishes achieved with hexavalent chromium. Although trivalent chromium can now exceed the equivalent hexavalent chromium performance for these colours, they are not capable of replacing brown, olive drab and black finishes. Their corrosion resistance is extended to match or exceed Cr(VI) performance by using additional coatings, see Section 2.5.11 and Section 2.5.17.

Economics

Savings in reduced effluent treatment costs, and health and safety management including scrubbing any extracted air.

Driving force for implementation

The ELV and ROHS Directives.

Also reduces health and safety requirements, as well as expenditure on aerosol suppression, air extraction and monitoring for hexavalent chromium in the workplace atmosphere.

Reference literature

[3, CETS, 2002] (Personal communication, Berthold Sessler, CETS) [98, EC, 2003, 99, EC, 2000].

4.9.10.3 Chromium-free conversion processes**Description**

Chromium-free processes are based on treatments with a composite organic-zirconium fluoride solution, treatments with titanium fluoride, or treatments with organic silicon derivatives (silanes). They may require a subsequent polymer layer, such as electrophoretic lacquer, to achieve required corrosion resistance, see Section 2.5.11..

There are black dyeing methods, which must be supplemented by sealing or topcoats for appearance and anticorrosion

Achieved environmental benefits

Minimisation of hexavalent chromium released.

Cross-media effects

MSDS-based alternatives may be as toxic as Cr(VI).

Applicability

Chromium-free solutions on the market are not yet fully able to provide zinc corrosion protection equivalent to chromate conversion coatings. These new processes still have some limitations with regard to the level of corrosion protection and the required bonding capability with any subsequent polymeric layer applied for functional and/or decorative purposes. There are chrome-free solutions, comparable to chrome conversion coating solutions, for aluminium

Driving force for implementation

As for Section 4.9.6.

Reference literature

[3, CETS, 2002] [76, BSTSA, , 104, UBA, 2003] (Personal communication, Johannes Lusser, ESTAL) [152, ESTAL, 2004] Technical specifications for aluminium surface treatment: QUALICOAT.

4.9.11 Chromic acid anodising

Description

See Section 2.5.13.

Applicability

Used largely prior to powder coating but also in aerospace, electronics and other specialist applications, as residues cause no corrosion with aluminium or alloy substrates.

Reference literature

[90, EIPPCB,]

4.9.12 Phosphochromating (phosphating with chromium)

Description

Sealers and phosphochromate finishes can contain hexavalent chromium. Phospho-chromating processes for aluminium produce layers containing trivalent chrome and phosphates. Many of these can be replaced with non-CrVI systems. Examples systems based on are silanes, zirconium and titanium.

Achieved environmental benefits

Minimisation of Cr(VI) and hence discharges to air and water.

Cross-media effects

Some of the alternatives may be as toxic as Cr(VI) (according to the materials safety data sheets).

Driving force for implementation

Occupational health, ELV and REE Directives.

Reference literature

[71, BSTSA, , ESTAL, 2004 #152] [98, EC, 2003, 99, EC, 2000]

4.9.13 Substitution for mechanical polishing and buffing

Description

Acid copper plating has an excellent levelling capability. It can sometimes be used to replace polishing and buffing processes.

Achieved environmental benefits

Reduction or elimination of dust and noise from mechanical processes.

Cross-media effects

Increased waste water treatment requirements.

Operational data

Specification of the basic roughness and the necessary layer thickness are not given.

Applicability

Suitable for workpieces prior to decorative nickel and copper plating.

Economics

Investment in polishing and buffing is replaced by investment in acid copper processing.

Driving force for implementation

Simplified health and safety requirements.

Reference literature

[3, CETS, 2002, 113, Austria, 2003].

4.9.14 Substitution and choices for degreasing**4.9.14.1 Mechanical pre-cleaning - centrifuging****Description**

Excessive oil and grease can be removed mechanically, i.e. by centrifuging or by air knife (see Section 2.3.5 for alternatives) before other forms of degreasing, such as chemical or solvent.

Achieved environmental benefits

Extends the life of degreasing solutions. Savings in chemicals and other inputs for degreasing. Reduction in wastes produced.

Cross-media effects

Power consumption in centrifuging and other mechanical techniques.

Operational data

The majority of oil deposits on small components can be removed by centrifugal force, providing the components can withstand the mechanical load without distortion, e.g. screws, bolts, nuts and nails. In most cases, removed oil can be recycled after filtering. Cleaning is often improved by warming the components to decrease the viscosity of the oil.

Workpieces can be destroyed or surfaces for decorative finishing damaged.

Applicability

The majority of small oiled components, usually undergoing barrel treatment. Energy used for heating components prior to centrifuging.

Driving force for implementation

Reduced subsequent degreasing treatment, reducing degreasing chemicals, power consumption, and improving quality.

Reference literature

[3, CETS, 2002]

4.9.14.2 Solvent degreasing**Description**

See Section 2.3.3.

Achieved environmental benefits

Low heat consumption.

Cross-media effects

Because of the classification of certain CHCs as potentially carcinogenic materials, their water-endangering potential and problems with emissions to the air and their use is strongly regulated (see Driving forces for implementation, below). Alternative solvents are inflammable.

The use and control of this technique may be discussed in the BREF on the Surface Treatment using Solvents.

Operational data

Good cleaning efficiency, quick drying.

Applicability

Almost universally applicable, see Section 2.3.3

Driving force for implementation

Used for high specification work, e.g. some aerospace or military applications.

Used where water-based treatments can damage the surface being treated.

Example plants

Have been widely used.

Reference literature

[90, EIPPCB,] [12, PARCOM, 1992, 93, EC, 2000, 96, EC, 2003, 97, EC, 1999]

[165, Tempany, 2004]

4.9.14.3 Chemical aqueous (soak) degreasing

Description

This section refers to cyanide-free aqueous degreasing, see Section 2.3. Cleaners can be of varying pH strengths and surfactant types and concentrations, according to the input oil/grease load, the substrate being treated and the requirements of the subsequent processes.

Achieved environmental benefits

The acids and alkalis used are simple and easy to treat in typical waste water treatment plants, unless strong chelating agents are present (see EDTA, Section 4.9.1 and waste water treatment, Section 4.16.8).

Cross-media effects

Process tanks operate at 40 - 90 °C and may require fume extraction to remove water vapour and alkaline or acid fumes.

Metals can be stripped from the substrate surface, (including trace elements such as lead, in some steels. They can be separated after pH adjustment.

Used acid or alkali solutions are often treated separately as they create a large pH change which may not be accommodated by continuous flow waste water treatment plants.

The surfactants present are not usually eliminated by a typical waste water treatment plant. Cleaning solutions may need to be separated from other process effluents to avoid interference with the waste water treatment plant by excess surfactants.

Maintenance can extend bath lives, see Section 4.11.13

Operational data

Short process solution life, depending on the throughput and the amount of oil and grease removed.

Applicability

Water-based degreasing systems offer well proven alternatives to solvent-based systems in almost all cases.

Cleaning processes for zinc and aluminium must be at or near neutral pH.

Emulsifying degreasing solutions have better degreasing efficiency, but are more difficult to regenerate than unstable emulsion (weak emulsion) systems. Applicability may need to be determined in each case.

Driving force for implementation

Health and safety, replacing solvents in the workplace.

Example plants

Worldwide usage.

Reference literature

[IHOBE, 1997 #6; UBA, 2003 #104, CETES, 2002 #3[124, Germany, 2003]

4.9.14.4 Weak emulsion degreasing**Description**

This is a variation of chemical aqueous degreasing, using a more easily maintained solution. Surface-active agents used in weak emulsion degreasing solutions are developed chemically so they do not form a stable emulsion with the removed oils and greases. The degreasing tanks are drained to a holding tank (usually for a group of degreasing tanks) for the removal of floating oils and sediments. Weak emulsion cleaning solution separates by itself, so that simple mechanical systems (skimmers) can be used for the removal of the oil. By the continuous removal of contamination via the holding tank and feedback of the cleaned degreasing solutions in the bath, a high service lifetime is achieved.

Weak emulsion degreasing systems offers thereby a compromise between the two requirements for degreasing systems:

- a smaller (but still sufficiently high) oil-absorbing capacity than strongly emulsifying degreasing baths;
- they can be substantially more easily regenerated and re-used.

The type of systems to be used can be derived from these characteristics.

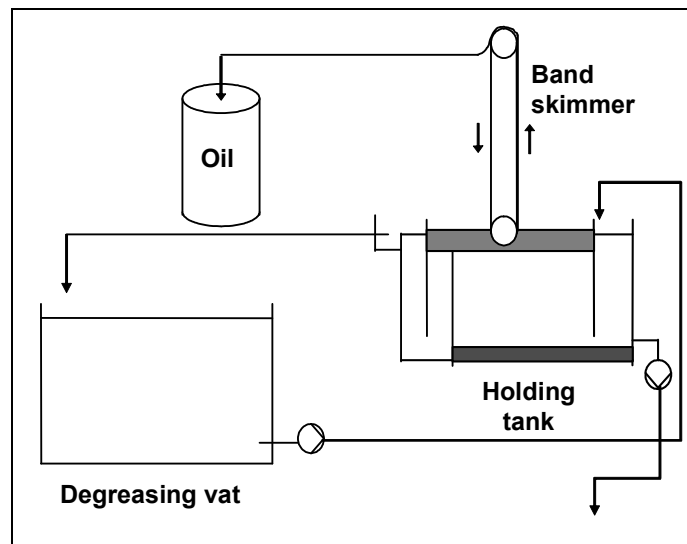

Figure 4.21: Weak emulsion degreasing system with holding tank for cleaning
[104, UBA, 2003]

Achieved environmental benefits

Minimisation of chemical and power consumption in cleaning.

Cross-media effects

Small additional power consumption required for pumping and oil recovery.

Operational data

The advantage of a weak emulsion system is that the solution is constantly being refreshed by having the oil removed.

Weak emulsion degreasing can leave grease/oil films on the panels of barrels - especially from the first bath. This film can be carried through all the vats in the plant. The grease/oil films from cleaners with weak emulsions can block ion-exchanger resins and membranes for membrane processes if these are used for recirculating rinses in the plant. These effects do not exist with stable emulsions

Applicability

Numerous cases are known in practice, where the conversion to a weak emulsion degreasing systems has given satisfactory cleaning.

Workpieces with strongly adhering pollution or with very viscous oils or grease on the surface cannot be cleaned by weak emulsion systems.

Strongly emulsifying systems have better degreasing capabilities, but are more difficult to regenerate. It is advisable to determine applicability on a case by case basis.

Economics

The investment in this type of plant may be high particularly if taken in conjunction with the maintenance options in Sections 4.11.13. A complex investment is only likely to be cost-effective if the process line and the amounts of oil and grease involved are large.

Driving force for implementation

Improved down-stream process control.

Reference literature

[104, UBA, 2003], [118, ESTAL, 2003], [113, Austria, 2003].

4.9.14.5 Biological degreasing

Although often referred to as a substitute technique, this is a maintenance technique for weak alkali degreasing baths that overcome their short lifetime by constant bypass regeneration. It is described in full in Section 4.11.13.4

4.9.14.6 Dry ice

Description

See Section 2.3.5.3

Achieved environmental benefits

Removal of oil, grease and particles, paint, etc. without the use of solvents.
Dry waste containing only removed components.

Cross-media effects

Noise and energy to form and propel dry ice pellets.

Operational data

See Section 2.3.

Applicability

This method is used mainly for cleaning pressing forms and other special parts. In special cases it is used to strip coatings (organic and metallic).

Driving force for implementation

Removal of paint without solvents and solvent emissions.

Reference literature

[116, Czech-Republic, 2003]; CETS, 2003 #115]

4.9.14.7 Ultrasonic cleaning

Description

Ultrasonic cleaning uses high frequency sound waves to improve the cleaning efficiency of aqueous, semi-aqueous and solvent cleaners. By generating zones of high and low pressure in the liquid, the sound waves create microscopic vacuum bubbles that implode when the sound wave moves and the zone changes from negative to positive pressure: this is called cavitation. If this occurs at the surface to be cleaned, the pressure cycles lead to local impacts, resulting in a mechanical action at the surface. Theoretically, localised pressures of >1000 bar are generated, dislodging grease and dirt.

Cleaning agents make this a viable process in aqueous solutions.

Achieved environmental benefits

More effective cleaning with less hazardous chemicals, when using aqueous solutions.

Cross-media effects

Waste water may include includes phosphates, surfactants, polishing paste and metals contained in it (copper and zinc).

Causes high frequency noise, which may be above 85dB.

A power consumption of 10 W per litre is reported.

Solvent systems contain volatile organic solvents.

Operational data

Process advantages: the surface that needs to be clean is not attacked; good degreasing efficiency and short operation time. Suitable for high specification cleaning.

Chemically efficient cleaners and higher temperature accelerate the process. Cleaners can be:

- alkaline (pH 8 – 14) although >pH10 may attack some substrates such as aluminium, zinc)
- neutral (pH 7 – 9.5) are used to remove dirt
- acid (pH 2 – 6). These remove oils and grease, although not as well as alkaline agents. They are used for cleaning oxidised surfaces.

Organic solvents have good properties for removing pastes and have the advantage of drying fast. They are expensive and more toxic than aqueous solutions.

The possible imbalance of the transducers can cause wave shock zones and dead zones, giving uneven cleaning.

Parts may fall from jogs due to vibration.

Applicability

Widely applicable. Does not attack surfaces to be cleaned (such as copper, zinc).

Economics

Cost for installation in an automatic electroplating line with this system is approximately EUR 80000 (2004).

Driving force for implementation

Wide applicability and high quality of cleaning.

Example plants

At least two installations in Portugal.

Installation A: 250 litres, uses an aqueous degreasing bath without silicates and with neutral pH; removes polishing paste:

- working temperature: 60 °C
- bath duration: 1 week
- ultrasound power: 1200 W.

Installation B:

- bath working temperature: 55 - 60 °C (heating by electrical means)
- bath solution life: 90 days
- consumption: 50 kg of chemicals/month
- process disadvantages: cost of the equipment.

Reference literature

(Personal correspondence. S Gomes, Instituto do Ambiente, Portugal) [159, TWG, 2004]
See Annex 8.8

4.9.14.8 Electrolytic cleaning with pH control

Description

Electrolysis in a degreasing solution is used to remove grease and dirt prior to the coating operation (see Sections 2.3.8 and 2.9.3.1). The degreasing solution is continuously monitored using pH to measure its effectiveness and to control the addition of new solution.

Achieved environmental benefits

Minimises the use of degreasing solution and the amount of waste solution requiring treatment. Reduces the volume of waste water and sludge from the waste water treatment plant.

Cross-media effects

Production of an explosive mixture of gases (O₂ and H₂).

Operational data

The process reduces the contamination of the plating solutions and contributes to less rejects of the finished product.

Applicability

New and existing plants prior to the coating process sections.

Economics

Approximate costs for large scale coil installations are an initial investment of EUR >0.8/t along with operating costs of EUR 0.015 - 0.8/t installed.

Driving force for implementation

Process quality and efficiency.

Example plants

Many coil coating plants.

Reference literature

[19, Eurofer, 2003]

4.9.14.9 High performance degreasing systems

Description

For high quality cleaning, aqueous systems are used which can be supplemented by electrolytic action. High quality cleaning is essential with modern process solutions such as acid zinc, etc.

In the case of strongly oiled parts, multistage degreasing can be advantageous. For the first stage, a hot water pre-degreasing or an unstable emulsion cleaning solution is used (see Section 4.9.14.4). For a second stage, a more strongly emulsifying cleaning solution is used. Also the combination of any two degreasing baths in sequence with the second, cleaner bath being used to replenish or replace the first, dirtier bath extends the service life of the degreasing solutions considerably.

Achieved environmental benefits

Extension of life of degreasing solutions. Reduction of reworking.

Cross-media effects

Energy consumption in higher temperature systems.

Economics

Case specific.

Driving force for implementation

Improved quality of workpieces or substrate for subsequent processing.

Reference literature

[3, CETS, 2002, 104, UBA, 2003]

4.9.15 Other degreasing techniques

Description

Many alternatives are mentioned in Section 2.3, such as:

- air knives and rollers: for sheet metal, flat pressed components and wire, the majority of oil can be removed by passing through a divider that can be mechanical (a wringer roller) or an air knife
- cyanide degreasing: thought to be obsolete
- hot water: hot water (80 - 90 °C) without chemicals can remove the majority of oil and grease. This method is used mainly in the automotive industry when cleaning pressed sheet steel. Using a high pressure water jet further improves the effect.
- hand wiping: large and/or high value components can be cleaned manually with cloth or paper wipers.

Some of these are newer techniques (e.g. air knives, dry ice) and are not widely used. Hand wiping is for specific applications, e.g. for high value components.

Achieved environmental benefits

Extends the life of degreasing solutions.

Cross-media effects

Hand wiping can produce large amounts of wastes, such as paper wipers and solvents. In addition, the use of solvents is poorly controlled.

Applicability

Depends on size and type of components: see Description, above.

Driving force for implementation

Reference literature

[3, CETS, 2002, 112, Assogalvanica, 2003] [90, EIPPCB, , 129, Spain, 2003]

4.9.16 Substitution by alternative processes

Description

The manufacturing industry is moving towards performance standards, such as corrosion resistance achieved. This is being catalysed where the use of traditional coatings (such as zinc and hexavalent chromium passivation) are being challenged by recent Directives being implemented limiting the amount of hexavalent chromium in end-of-life products. This change is challenging traditional specifications.

To achieve modern high standards for corrosion prevention, multilayer systems are increasingly used. This enables the operator to offer alternative systems to customers that achieve the same performance criteria, and the potential to move away from more polluting processes. For example:

- electroless nickel for some hard chromium applications
- zinc alloys in place of zinc and chromium passivation, in conjunction with organic lacquers applied by dipping or electropainting
- electropainting in conjunction with phosphating (see the Solvents BREFs [90, EIPPCB,]).

Note: As an example, substitution has already been widely achieved for cadmium electroplating as marketing and use regulations required many specifications to be changed to utilise alternative surface treatments.

Alternative processes not in the scope of this document

Metals can be applied by physical methods, such as vapour phase deposition. They are not within the scope of this document. However, an operator may wish to consider them as a clean technology option, as set out in IPPC Directive, Annex IV. While such techniques are ‘clean technology’ at the point of use, they may produce some cross-media effects, such as higher energy usage.

Examples of such techniques are:

- vapour phase deposition of aluminium on plastic for automobile lighting reflectors
- vapour phase deposition of chromium as a decorative finish, such as bathroom fittings.

Hard chromium can be replaced in some applications by alloyed WC-Ni(Co)Cr/Cr₂O₃, or by high velocity oxy-fuel spraying or plasma spraying.

The US Defence Department is funding a study on alternatives for chromium conversion coatings, and USEPA have also researched the replacement of chromate conversion coatings on aluminium and zinc.

Achieved environmental benefits

Reduction of toxic emissions.

Cross-media effects

To be investigated for each application.

Operational data

To be determined for each application.

Applicability

To be determined for each application.

May be limited by existing specifications.

Economics

To be determined for each application.

Overall, regulation of mass customer sectors will drive a shift away from traditional standards for surface treatment.

Driving force for implementation

Health and safety and product regulations, such as automotive and electronics Directives.

Reference literature

[68, USEPA, 2003, 106, NCMS, 2003] [94, EC, 1999, 96, EC, 2003, 98, EC, 2003, 99, EC, 2000] [30, EC, 2003] [121, France, 2003] [106, NCMS, 2003] [66, PPRC, 2003, 68, USEPA, 2003]

4.10 Common techniques for treating waters and aqueous solutions: feed-water, rinses, waste water treatment, process solutions, and materials recovery

Many techniques can be used with waters and aqueous solutions, to:

- remove unwanted materials, such as:
 - cleaning incoming water for rinsing
 - recycling rinse-waters
 - removing breakdown products or tramp metals in process solutions
 - treating waste water prior to discharge
- remove the water to concentrate the materials, such as to recover drag-out, recovery of materials from waste waters

Table 4.12 lists the sections which discuss the application of treatment techniques.

Section	Subject or techniques
4.4.5.1	Water supply, treatment and recycling/re-use
4.7	Rinsing techniques and drag-out recovery
4.7.8	Regeneration and re-use/recycling of rinsing waters
4.7.11	Increasing drag-out rate and closing the loop
4.7.12	Combining techniques and installation-wide approaches
4.11	Process solution maintenance
4.11.13	Maintenance of degreasing solution
4.11.14	Pickling
4.12	Recovery of process metals
4.16	Waste water emission abatement techniques
4.16.12	Zero discharge techniques

Table 4.12: Sections discussing the application of treatment techniques

A list of the current common techniques used singly or in combination to achieve a variety of objectives is given in Table 4.13.

Table 4.14 in Section 4.11 lists common process solutions, their disturbing pollutants and their treatment techniques.

Technique	Applicability: references to sections with examples of uses (Key process descriptions are marked *)	Limitations	Cross-media effects
Filtration	Widely used for: <ul style="list-style-type: none"> incoming water supplies (4.4.5.1) process solution maintenance (4.11.1*) waste water treatment (4.16.10). 	Limited to the removal of solids except when used in conjunction with an absorption technique.	Generation of waste solids, used filter media, etc. Energy used in pumping.
Absorption techniques	Activated carbon to remove organic breakdown products from solutions (4.11.6*). Granulated polypropylene felt, or other lyophobic media are used to absorb oils in filter housings or as ropes, clothes etc. used (4.11.13.2*). Polymer filtration is used to selectively bind target metals.	Activated carbon can also indiscriminately remove active organic additives.	Generation of waste solids, absorption media, etc. Energy used in pumping.
Crystallisation	Some etching or pickling baths with relatively high concentrations where controlled metals removal and recovery can be beneficial, e.g. copper from peroxide-sulphuric acid solutions. Removal of carbonates to maintain alkaline and cyanide plating solutions (4.11.4*). Also for acid pickling, and aluminium etchant (4.11.5*)	See Applicability.	Energy used for cooling and pumping.
Atmospheric evaporation: natural and assisted (evaporators, etc.)	Used to concentrate process solutions or rinses. (4.7.2, 4.7.11.2*, 4.7.11.3*) In some cases, the distillate can be re-used in rinsing in the process. The distillate may trap spray from the process (such as in Cr(VI) plating.	In some applications there is a risk of over-concentration and fouling of the evaporator due to salting out. Surfactants can cause foaming problems Some bath constituents may be heat degraded or oxidised. Aeration can cause build up of carbonates. Recovery results vary depending on changing process and air stream conditions.	When the feed streams and/or air streams need to be heated, atmospheric evaporators have a high energy use. The discharged air may contain hazardous substances. If the distillate traps process spray and is not returned to the solution, it may require treatment.
Vacuum evaporation	Used to concentrate process solutions or rinse-waters (4.16.12.1.1*) where: <ul style="list-style-type: none"> air pollution is potential problem relatively low evaporation temperatures are needed to avoid problems with solutions sensitive to temperature and/or oxidation alkaline cyanide solutions that build up carbonates easily energy costs are high for atmospheric evaporation. Produce high-quality condensate that can be re-used and a concentrate that that may be re-used, recycled or is managed as waste.	High capital cost. Application-specific potential for fouling and separation limitations.	Periodic waste streams form clean out if there is fouling. Some concentrated wastes may be difficult to dispose of if not recycled or re-used.

Technique	Applicability: references to sections with examples of uses (Key process descriptions are marked *)	Limitations	Cross-media effects
Electrolysis – Recovery of metals	Widely used to recover precious metals, copper, zinc, tin, tin/lead. The more noble the metal, the easier plating out is (4.12.1*). Best carried out from concentrated solutions, such as a static rinses, and in combination with other techniques e.g. ion exchange regenerates and reverse osmosis concentrates (4.7.12). There are options to improve efficiency and overcome electrode polarisation and low ion diffusion rates.	Chromium is the only common metal not usually recovered (but see 4.12.1*). Minimum practical concentrations vary, but plating from low concentrations difficult (see Applicability). Metals recovery can be difficult for solutions that contain chelated or complexed metals, reducing agents or stabilisers.	High current use if concentration is very low.
Electrolysis – plating out	Removal of metallic impurities (at low current densities, LCD) which accumulate with time, e.g.: <ul style="list-style-type: none"> nickel strikes, and plating nickel, copper, cadmium, and trivalent chromium (4.11.8*) removing excess metals (4.11.9*) purifying acids (e.g. sulphuric from copper wire pickling). 		
Electrolysis – oxidation	Oxidation of cyanide solutions (4.16.4). High-current density (HCD) to oxidise Cr(III) to Cr(VI) and organic by-products (4.11.10*).		
Ion exchange – resin	General description Annex 8.7* 1. Used to remove ions to increase of water: <ul style="list-style-type: none"> improving incoming water quality in deionisation water softening applications (4.4.5.1) rinse-water recovery (4.7.8.1) waste water treatment applications (4.16.10) 2. Concentration of ions onto resin, and recovery of concentrated metals solution (4.12.2)	Ion exchange may become impractical for use with total dissolved solids concentrations above 500 ppm, due to the need for frequent regeneration. Different resins have different effective pH ranges. Oxidants, solvents, organics, oil and grease, and strong acids or alkalis (with the inappropriate resins) can degrade resins. Suspended solids can clog resin columns.	Chemicals used in regeneration. Impacts of waste solutions from regeneration. Energy consumption used for pumping.
Electro-deionisation	Effective for relatively high purity water purification/recovery applications, such as polishing treatment of reverse osmosis permeate (no example).		No chemical usage in resin regeneration.
Acid (resin) sorption or retardation	Regeneration of acids, particularly for pickling and etching (4.11.3*) including anodising (4.11.3.1*)	Not applicable for some highly concentrated acids. Should not be used on acids with anionic complexes that sorb to the resin, thus reducing acid recovery. Application-specific temperature limitations should not be exceeded	Only a part of the free or unused acid is recovered. 33 – 70 % of the acid may end up in the waste stream and require treatment.
Ion exchange – liquid/liquid	Currently only one application: in PCB manufacture, recycling of alkali (ammonia) etchants with copper recovery (4.15.7*)	High capital cost.	Some power consumption.

Technique	Applicability: references to sections with examples of uses (Key process descriptions are marked *)	Limitations	Cross-media effects
Membrane filtration microfiltration (MF) ultrafiltration (UF) nanofiltration (NF)	Input water purification (MF and UF, 4.4.5.1) Removal of oils and greases from degreasing baths (MF and UF, 4.11.13.6*) and in coil coating (4.14.7) Waste water treatment: increases amount of solids removed, and hence lower metals levels achieved, e.g. replace clarification and polishing applications, (4.16.10), zero discharge techniques (4.16.12), etc For PCBs, filtration of stripped resist from effluents (4.15.5).	Cleaning agents removed along with oils/greases. Cleaners with high silicate concentrations less amenable to treatment. Aluminium cleaning solutions not recycled due to build up of dissolved aluminium.	Waste oil/grease or solids to dispose of: Power consumption for pumping. Clogging of membranes, depending on solutions treated.
Reverse osmosis (RO)	Purifying input water for generating high-quality deionised water (4.4.5.1) Separation and recovery of rinse-waters and chemical for: In general (4.7.8.2*) nickel electroplating (4.7.11, 4.7.11.5 copper (acid and cyanide) acid zinc chromate Large-scale waste water recycling. In combination with other techniques: (4.7.12, 4.16.12.2)	Membrane performance deteriorates with time. Membranes subject to fouling by organics, water hardness, suspended solids (may require pre-filtering, prior pH control and control of ionic concentration). Some ions such as borates show poor rejection. Oxidising agents can damage membranes, as well as acid or alkali solutions >0.25 molar. Osmotic pressure limits RO to <5000 ppm TDS.	Energy for pumping to overcome osmotic pressure of solution.
Diffusion dialysis	Maintain or reclaim spent or contaminated acids where acid concentrations are >3 % w/w, such as: For HCl, H ₂ SO ₄ HNO ₃ pickle and strip solutions (4.11.14.2*) anodising solutions HNO ₃ /HF stainless steel pickling solutions HCl/H ₂ SO ₄ aluminium etch solutions methane sulphonic acid (MSA) solutions	Acids not highly dissociated (e.g. H ₃ PO ₄) will not diffuse across the membrane. Complexed metal anions (e.g., fluorotitanium) can readily diffuse and are not well separated. Cooling may be needed if influent >50C or heating if cold.	The recovered acid is not full strength and fresh acid is still needed. Depleted acid waste stream contains 5 – 20 acid and 60 – 95 % of metals from influent, which require treatment. Requires deionised water supply.
Membrane electrolysis	Extends bath life for chromic acid solutions and other acid based etchants (including for plastics), pickling and stripping solutions. Removes contaminants. Oxidises Cr(III) to Cr(VI) (4.11.11*) Multi-cell systems can be used with highly corrosive acids. Extending life of autocatalytic nickel solutions (in 3.2.3.4)	Special materials may required for construction. Anionic metal complexes require pretreatment. Operating temperatures limited between 15 – 60 °C. Oil, grease and solvents can damage membranes. Suspended solids and precipitates can clog membranes.	Hazardous fumes may be generated.

Technique	Applicability: references to sections with examples of uses (Key process descriptions are marked *)	Limitations	Cross-media effects
Electrodialysis	Maintain nickel electrolytes by removing organic decomposition products (preserves ductility of the nickel deposit). (4.11.2) Maintain and extends life of electroless nickel solutions (4.11.2). Extends life of pickling acids and etching solutions (such as for tin, tin/lead) (4.11.14.2*) Recovery of metals from rinse-waters, e.g. nickel (4.7.11.4*).	To prevent blocking of the membrane, pickling acids must be pre-filtered.	Power consumption.

Table 4.13: Common techniques for treating aqueous systems

4.11 Process solution maintenance

Proper control of bath operating parameters will result in more consistent workpiece/substrate quality as well as longer bath life. This requires determining critical operating parameters and maintaining them within the established acceptable limits [67, IAMS, 2003].

Contaminants which affect the quality of treatment accumulate in process solutions as conversion or decomposition products during processing or drag-in from preceding solutions with the workpieces/substrates. Batch or continuous maintenance and regeneration are therefore necessary especially when the renewing function of drag-out is eliminated through drag-out recovery.

Particularly when carrying out solution maintenance on a batch or ad hoc basis, care must be taken to prevent spillages when pumping concentrated solutions from tank to tank, by ensuring all tanks are properly and evenly supported inside contained areas, pump drips and spillages are collected and pipework is secure, see Section 4.2.1.

In principle, there is a difference between electrochemical and chemical process solutions.

Electrochemical procedures with dissolving anodes are based on metal ions migrating to the cathode in the applied electrical field and are reduced to the metal. In electroplating, the workpiece or substrate is connected as a cathode, while the anode usually consists of the metal to be deposited. Within the electrical field ideally the same quantity of metal dissolves from the anode, as it is cathodically deposited, so that the composition of the process solution remains essentially constant. That means that the service life of the process solution of electrochemical processes is theoretically infinite. However in practice the process solutions suffer quality losses by the entry of impurities and formation of interfering substances by different causes, such as:

- introduction of interfering substances from preceding process solutions due to insufficient rinsing
- dissolving of base metal (in particular with acid working process solutions)
- chemical change of the process solutions (reduction of Cr(VI) to Cr(III) with the chromium plating, carbonate formation by reaction of CO₂ from air in alkaline cyanide process solutions)
- higher dissolution of anode metal than separation at the cathode
- decomposition of organic compounds in the process solutions.

In other processes, chemicals are also consumed, such as the reduction of metal ions to metal by chemical reducing agents at activated sites on the basic material in autocatalytic plating, or other chemical reactions take place (such as layer conversion). Metal ions, reducing agents and other chemicals must be added in salt form constantly, so in principle the service life of these solutions is limited.

Because of these degradation processes, the quality of a process solution can deteriorate to the extent that it must be discarded, unless it is possible to keep the quality of the process solutions constant by the application of a regeneration technique, such as those described in this section.

The procedures described this section are not limited exclusively to electrolytes. They include the care of pickling and etching solutions, degreasing solutions, etc. The remarks are limited to the technical description of the individual procedures for avoidance and decrease of environmental nuisance.

The following Table 4.14 shows the most significant disturbing solution pollutants for many processes.

Some are dealt with elsewhere and are cross-referenced:

Process Solution	Disturbing pollutants	Remarks	Maintenance technique	Reference to description of technique
Soak cleaner	Sludge of oil, liquid grease, metal slivers, dirt etc.	Removed from the work	Described in detail in Section 4.11.13	4.11.13
Pickling of metals	Dissolved metal	Large volumes only	Retardation	4.11.3
Pickling of plastics	Dissolved resin reduced oxidising agent	Balance situation	Reoxidation through ceramic membrane	4.11.10
Desmear of multilayers	Dissolved resin Cr(VI) and O ⁴⁻⁻		Electrolytic reoxidation	4.11.10
Electrolytic cleaner	Dissolved metal, oil, grease	Use overflow compartment	Skimmer	4.11.13.8
Cyanide copper	Redundant copper	May be used in an extra tank for cyanide oxidation for waste water treatment and/or Cu recycling. In the plating bath, it will oxidise cyanide to ammonia and carbonate, which are unwanted decomposition products.	Insoluble anodes with individual DC supply	4.4.1.2
	Decomposition products of organic additives, carbonates		Active carbon treatment Dilution of solution	4.11.6
Acid copper	Redundant copper		Dilution of solution	
	Decomposition products of organic additives		Active carbon treatment	4.11.6
Electroless copper	Decomposition products		Feed and bleed	
Dull nickel, Watt's type	Redundant nickel		Membrane anodes with individual DC supply	4.4.1.2 4.8.2
	By-metals		Selective plating cathode at low current densities	4.11.9
				Electrodialysis can be used to remove breakdown products
Bright nickel, Watt's Type	Redundant nickel		Dilution of solution	4.4.1.2 4.8.2
	Decomposition products of organic additives		Active carbon treatment	4.11.6
			Electrodialysis	4.11.2
	By-metals as Zn, Cu, Fe		Adsorber resin treatment	4.11.7
			Elective plating cathode at low current densities	4.11.9
Sulphamate nickel	Decomposition products of surfactants		Electrodialysis can be used to remove breakdown products	4.11.2
			Active carbon treatment	4.11.6
Electroless nickel for plastics	Orthophosphite, sulphate, sodium palladium		Replace after lifetime Electrodialysis can be used to remove breakdown products	4.11.2

Electroless nickel for metals	Orthophosphite, sulphate, sodium		Replace after lifetime Electrodialysis can be used to remove breakdown products	4.11.2
Bright chromium and hard chromium	Cr(III), by-metals, dissolved from plated items		Static rinse-water recirculated over cation exchanger prior to balance evaporation losses of treatment solution	4.11.7 4.7
Alkaline zinc	Carbonates		Crystallisation of carbonate by low temperature treatment, batch and/or continuously	4.11.4
Cyanide Zinc	Redundant zinc		Insoluble anodes	4.4.1.2 4.8.2
	Decomposition products carbonates		Crystallisation of carbonate by low temperature treatment, batch and/or continuously	4.11.4
Acid Zinc	Redundant zinc		Membrane anodes with individual DC supply	4.4.1.2 4.8.2
	Decomposition products of organic additives		Active carbon treatment H ₂ O ₂ treatment with lots of air	4.11.6
	By-metal (iron)	Oxidise FeII to insoluble Fe III	High pH H ₂ O ₂ treatment and filter	
Zinc-nickel (alkaline)	Carbonates		Crystallisation of carbonate by low temperature	4.11.4
Zinc –iron	Carbonate		Crystallisation of carbonate by low temperature	4.11.4
Passivation	Conversion products of passivated zinc and zinc alloys, sulphate, by-metals		Feed and bleed	
Aluminium pickling Caustic etch recovery	Dissolved aluminium, Al(OH) ₃		Removal of Al(OH) ₃ NaOH	
Aluminium anodising (sulphuric)	Dissolved aluminium	Usually more economic to replace solutions, and use old solution to neutralise waste waters [113, Austria, 2003]	Retardation (see comments)	
Aluminium anodising (chromic acid)	Dissolved aluminium, Cr ³⁺	Filtration not appropriated	Feed and bleed Correct anode--cathode ratio	
Electrolytic colouring	Sn ⁴⁺ Aluminium enrichment		Feed and bleed	
Inorganic colouring	Drag in of sulphate and phosphate Iron hydroxide	Affects colour	Feed and bleed based on colour Filtration	4.11.1
	Free ferri-ammonium oxalate		Reaction with H ₂ O ₂	
Organic colouring	Numerous pollutants		Regeneration difficult	
Silver	Decomposition products, potassium carbonate	Based on potassium	Feed and bleed	
Static rinses	Metal hydroxides, depending on pH, surfactants and algae		Filtration	4.11.1
Phosphating baths	Metals, pH		adjust metals concentration and pH Filter	4.11.1

Table 4.14: Examples of techniques applied for maintenance of process solutions

4.11.1 Filtration of process solutions

Description

Particles suspended in electrolytes can generate negative effects on the layer quality (in particular by inclusion of the particles into the layer). The filtration of process solutions is used to remove particles (e.g. splinters or dirt), which were introduced by the workpieces/substrate, anode mud, dust from the air or the insoluble compounds developed during the process (such as metal hydroxides). In order to guarantee a continuous removal of the solids, the filter is operated in a bypass to the process tank, see Figure 4.22.

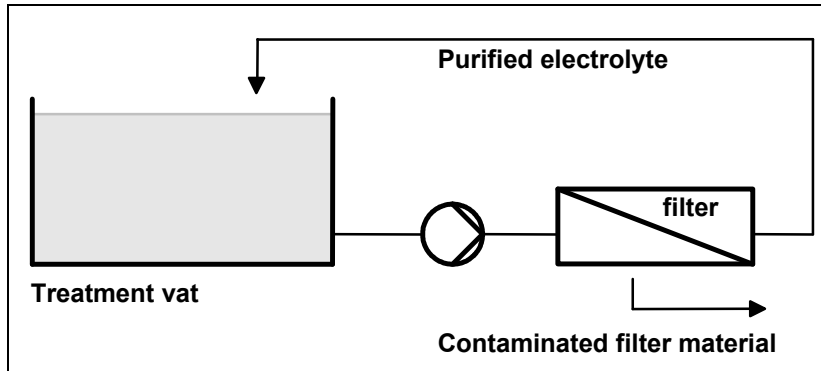

Figure 4.22: Filtration of process solutions

Achieved environmental benefits

Extension of the process solution life.

Cross-media effects

Energy consumption for pumping.

Renewable materials are preferred as a filtration medium, since increased waste results from disposable filters.

Filters which cannot be used any more despite back flushing are usually contaminated with hazardous solution remainders and need to be disposed of as hazardous waste.

Applicability

Many solutions can benefit. The filtration of process solutions in surface treatment is part of the normal practice to extend process solution life.

Economics

The investment required for filtration is small with costs of a few hundred to thousands of euros. They are usually economically viable, as insufficient filtration causes surface quality problems and the process solution must be rejected earlier than it otherwise need be, as well as the cost of reworking reject work.

Driving force for implementation

Reduction in frequency of replacing solution.

See Economics, above.

Example plants

Widely used in many installations.

Reference literature

[104, UBA, 2003].

4.11.2 Electrodialysis

Description

See also pickling, Section 4.11.14.2. Maintenance by electro dialysis, for example, removes organic decomposition products from nickel electrolytes and preserves the ductility of the nickel deposits. It is also used to extend the lifetime of electroless nickel plating solutions.

Achieved environmental benefits

Extension of bath quality and lifetime.

Cross-media effects

See Section 4.11.14.2

Operational data

See Section 4.11.14.2

Driving force for implementation

Example plants

Small installation: Siemens AG in Speyer (Germany)

Large installation: Otto Kynast in Quakenbrück (Germany)

Reference literature

[3, CETS, 2002]

4.11.3 Retardation (acid resin sorbtion)

Description

Retardation (or acid resin sorption) is an ion exchange separation technique used primarily for the regeneration of acids (e.g. pickling acids and etchants such as in anodising).

A high concentration solution containing metal (or acid salt) is pumped upstream through an ion exchange resin, where the major proportion of the acid anions penetrate into the resin of an anion exchanger while the metal cations are excluded by electrostatic repulsion, and pass through. In the second step, water is pumped downstream through the resin; the acid is set free again. The recovered acid can be re-used. A depletion rate of between 40 and 60 % can be achieved, depending on the type of acid and metal (see Figure 4.23).

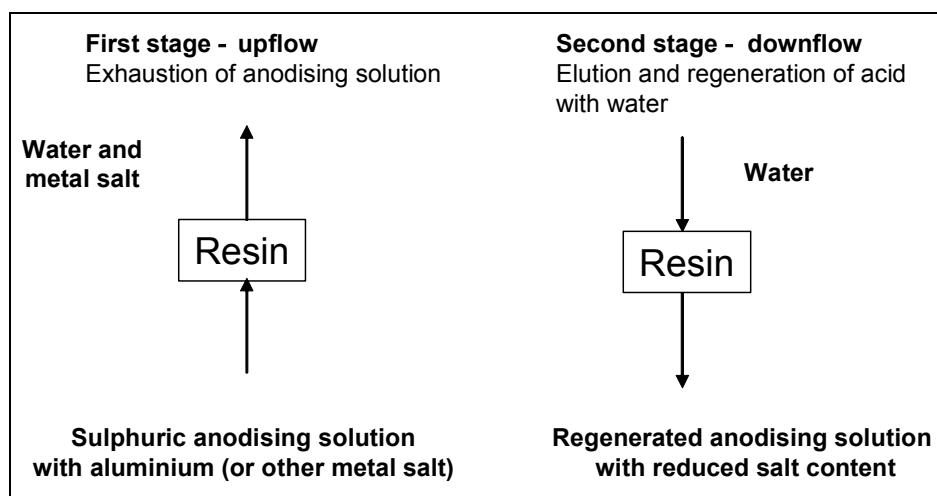

Figure 4.23: Retardation process

Achieved environmental benefits

Recovery of used acids.

Cross-media effects

The acid sorption process recovers only a portion of the free or unused acid. It does not recover any of the combined acid (salt). As a result, approximately 35 to 70 % of the total acid used is incorporated into a waste stream from the process and will require treatment. Depending on the metal involved, treatment will range from conventional neutralisation (pH adjustment with caustic) to metals removal (e.g., precipitation).

Operational data

Not applicable for some highly concentrated acids.

Should not be used on acids with anionic complexes that sorb to the resin, thus reducing acid recovery.

Application-specific temperature limitations should not be exceeded (e.g., approximately 32 °C for nitric acid, and up to 70 °C for sulphuric or hydrochloric acid).

Applicability

Can be used on

- sulphuric acid anodising baths for aluminium
- sulphuric or nitric acid pickling, etching, or brightening baths for copper or brass
- nitric/hydrofluoric acid pickling baths used for processing stainless steel
- phosphoric and/or sulphuric acid baths for stainless steel or aluminium electropolishing
- cation ion exchange acid regenerated solutions
- sulphuric or hydrochloric acid pickling baths for steel and galvanized steel.

Economics

See Section 4.11.3.1.

Driving force for implementation

Recovery of used acid, particularly to provide a constant acid quality to ensure process stability

See Section 4.11.3.1)

Example plants

See Section 4.11.3.1.

Reference literature

[3, CETS, 2002, 53, France, 2003, 86, EIPPCB, , 162, USEPA, 2000]

4.11.3.1 Retardation regeneration of sulphuric acid anodising solution

Description

The dissolved aluminium levels in the sulphuric acid anodising operation must be kept low. When the aluminium level in the acid reaches 15 - 20 g/l, the anodising bath is decanted or dumped. Continuous purification can eliminate waste and enhance the uniformity of the anodised film.

Operating an anodising bath presents a number of potential problems. There is a delicate balance within an anodising bath between the electrical resistance (caused by the oxide coating being created) the anodising solution conductivity, the applied voltage, and the controlled constant current condition. The electrical resistance increases according to the thickness of the oxide coating and decreases when aluminium concentration rises in the anodising solution. To compensate this increased resistance, the rectified voltage must be increased so that the current remains stable. Other variables such as bath temperature, degree of solution agitation, and sulphuric acid concentration cause a decline in product quality. Maintaining a stable low aluminium concentration removes or lowers a variable affecting the balance between resistance, voltage, and current.

An anodising bath containing 200 g/l H₂SO₄ and 5 - 10 g/l Al is passed over an anion exchange resin bed (preferentially upstream) until the sulphuric acid appears in the bed effluent and the whole resin becomes saturated with sulphuric acid.

When the resin is rinsed with demineralised water, the aluminium sulphate which is not absorbed by the resin beads appears first in the eluate, followed by the sulphuric acid, which has to be replaced by demineralised water from inside the resin beads.

Achieved environmental benefits

Extension of process solution life.

The whole pickling solution is recovered.

Cross-media effects

Retardation generates a high volume of waste water.

Alternatively, waste acids can be used in waste water treatment, replacing fresh acids for this purpose. This will depend on waste acid generation and waste water requirements.

Operational data

For optimum performance, it is essential that the acid concentration of the process bath exceeds 10 %.

Applicability

The efficiency of retardation decreases in the following sequence:

HCl > HNO₃ > HClO₄ > H₂SO₄ > (HF)_n > H₃PO₄ > tartaric acid.

Controlling the aluminium concentration and recovery of sulphuric acid for a continued process in the aluminium finishing industry has been carried out for years.

Economics

The cost of a regeneration unit system for sulphuric acid anodising is between EUR 30000 and 60000.

Driving force for implementation

The end result is ensuring a stable, predictable bath operation leading to cost savings and improved product quality.

Example plants

LRB Roulie, Nanterre, France

Reference literature

[53, France, 2003] [121, France, 2003] [3, CETS, 2002, 118, ESTAL, 2003]

4.11.4 Crystallisation of carbonates and metal sulphates

Description

Cold crystallisation is a technology by which interfering salts can be separated selectively from a process solution. These salts are formed by the dissolving of metals or metal oxides (pickling) or by unwanted reactions (oxidation of cyanide to carbonate). By cooling down a solution to <5 °C, the solubility of most of the salts is reduced. Only certain salts in the selected salt mixture crystallise with the cooling down of a solution, while the remaining salts stay in the solution, see Figure 4.24.

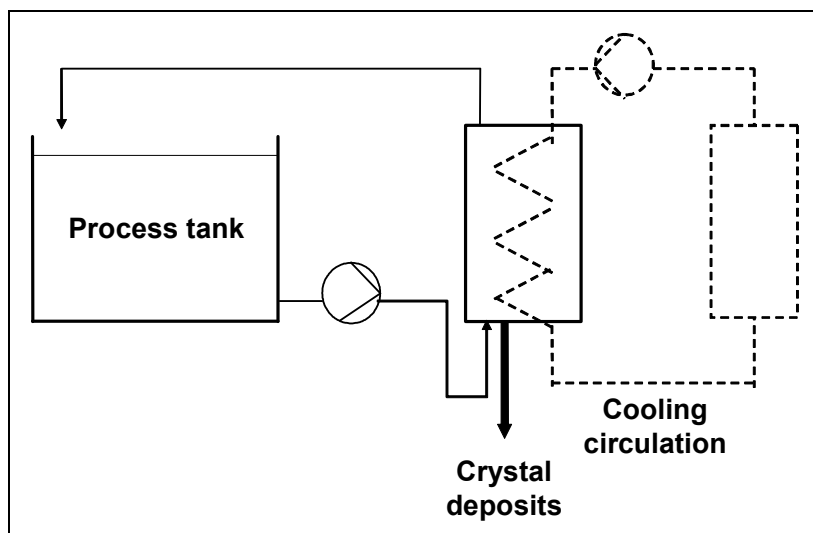

Figure 4.24: Operating principle of cold crystallisation

Simple systems can be utilised, where the solution is pumped to a tank that can be cooled naturally during a winter shut-down period. This also enables other maintenance to be carried such as checking tank liner integrity, removing broken jigs and dropped workpieces.

Achieved environmental benefits

Extension of the process solution life.

Cross-media effects

Additional energy will be required for cooling, where this is applied. This may be necessary in warmer countries.

For anodising, the additional energy requirements for cooling outweigh the benefits from crystallisation.

For cyanide solutions, the precipitated carbonate will contain cyanide.

The wastes produced will require management as hazardous wastes, unless the metal content is sufficiently high for recovery.

Simple pumping out systems increase the risk of spillages.

Operational data

The service lifetime extension attainable by cold crystallisation depends on:

- the type of salts to be frozen out of the electrolyte
- the process of salt formation
- the time necessary for the process.

In many cases, this is carried out in winter, especially during shut down periods, such as Christmas, when the solution can be cooled naturally.

Applicability

Due to the diversity of each application, an individual examination of each case is recommended.

Economics

For electroplating, the investment is in the order of EUR 15000 to 20000 for a cooling system.

Simpler systems using winter temperatures for cooling require only a tank and pump.

Example plants

In Germany, approximately 10 % of installations have this technique installed.

Reference literature

[104, UBA, 2003] [[118, ESTAL, 2003, 124, Germany, 2003]

4.11.5 Anodising caustic etch recovery**Description**

A hot solution of sodium hydroxide creates a decorative matt surface finish by removing a thin layer of aluminium. This etching process is caused by a reaction between the aluminium and caustic soda that produces sodium aluminate and hydrogen gas:

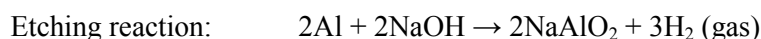

The etching process is typically responsible for 80 - 90 % of the aluminium in the waste treatment system.

Chemical stabilisers (complexing agents) are added to prevent the aluminium from precipitating out in the etch tank. Water is used to rinse the etching solution off the parts. The rinse-water carries dissolved aluminium and caustic to the plant waste treatment system.

If stabilisers are not used, the sodium aluminate concentration becomes too high and it will hydrolyse to produce alumina trihydrate ($\text{Al}_2\text{O}_3(\text{H}_2\text{O})_3$), liberating free caustic soda.

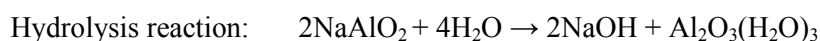

This reaction, known as the Bayer process, is used in the primary aluminium industry to make alumina. If not properly controlled, it leads to an accumulation of a rock-hard aluminium hydroxide scale in the etch tank.

A regeneration system recirculates the etch solution continuously between the etch tank and a separate crystalliser tank, where the etch solution is seeded with alumina crystals in a separate crystalliser tank. It is then possible to regenerate the etch solution without scale building up.

The hydrated alumina crystals formed in the crystalliser settle out in a settlement section. Regenerated etch solution, with reduced aluminium and increased free caustic levels, feeds back to the etch bath directly from the top of the crystalliser. Alumina crystals are withdrawn periodically from the bottom of the crystalliser and dewatered in a vacuum filter.

Achieved environmental benefits

Regeneration can reduce a plant's solid waste by over 80 % while lowering caustic chemical (and neutralisation) costs by over 70 %.

The removed alumina crystals may be used in a variety of alumina substitutes (however, this is dependant on quality, see Cross-media effects, below).

Cross-media effects

In some installations, to achieve a specific quality for specified products, additives may be added to the etching baths which generate impurities in the recovered alumina. The alumina is then impure and is not directly usable.

Operational data

The use of some additives may inhibit precipitation of alumina.
The process is difficult to control.

Applicability

Where the use of additives to achieve a specific surface specification does not interfere with the process or prevents the re-use of the alumina

Economics

Although these systems are relatively expensive to install, larger plants can recover their costs within two or three years.

Driving force for implementation

Economic and waste reduction.

Reference literature

[62, France, 2003, 152, ESTAL, 2004, 165, Tempany, 2004]

4.11.6 Activated carbon treatment

Description

Activated carbon filtration is an absorption technique (or adsorption, in the case of activated carbon) and used with filtration. Organic decomposition products in electrolytic solutions tend to disturb electrolytic metal deposition or the properties of the metal deposit itself. The major proportion of such products can be extracted from electrolytes through activated carbon treatment. The quantity of active carbon needed depends on the quantity of the products to be removed: up to 10 g/l may be necessary.

Activated carbon is mixed into the electrolyte and removed by filtration after a suitable reaction time. A combination of normal filtration and active carbon cartridges in by-pass is used to continuously remove both solid contaminants and soluble organic decomposition products from the electrolytes.

Achieved environmental benefits

Extension of process solution life.

Theoretically, contaminated activated carbon can be regenerated, but this is usually not economical or has associated limiting cross-media effects.

Cross-media effects

Additional energy in pumping. Used carbon filters may need to be disposed of as hazardous waste.

Operational data

The process is non-specific and also removes active process substances. Compensating additions need to be made to the process solution.

Applicability

The process is widely used, and frequently for bright nickel electrolytes.

Reference literature

[3, CETS, 2002, 104, UBA, 2003]

4.11.7 Ion exchange purification of metallic contamination

Description

Ion exchange is described in general in Annex 8.7. The technique can be used to selectively remove unwanted metal ions (cations) from aqueous solutions and cation exchange resins with special properties, such as resistance to strong oxidants, are used. An example for chromic acid regeneration is shown in Figure 4.25.

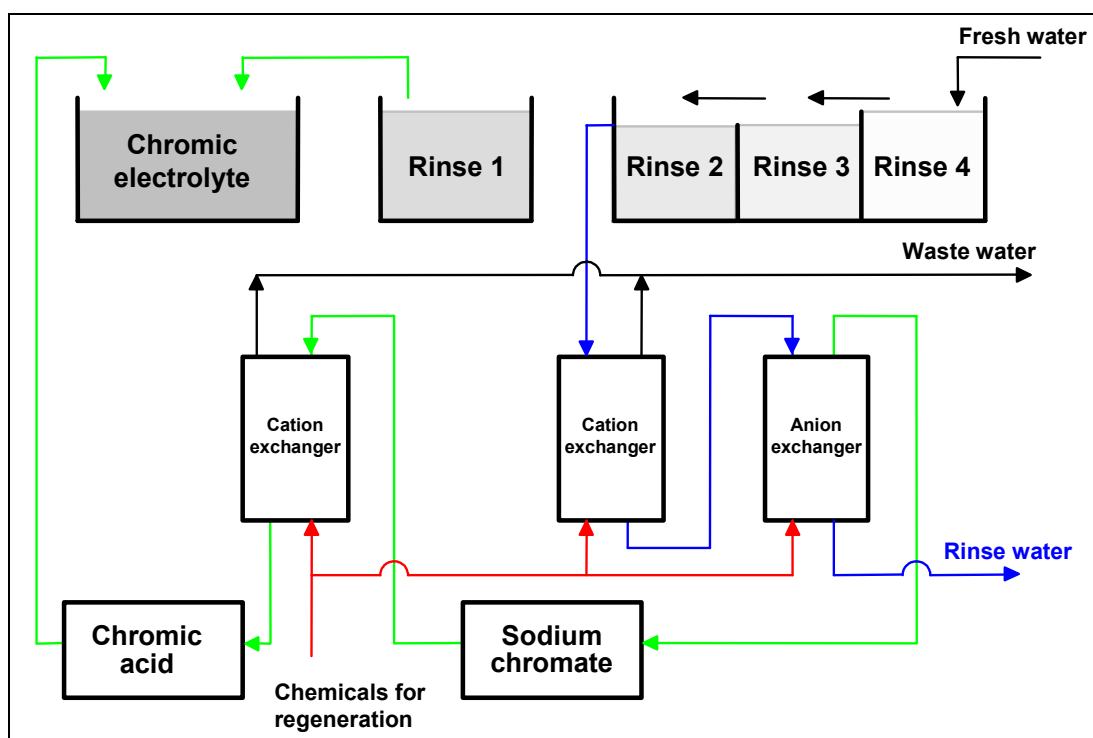

Figure 4.25: Chromic acid electrolyte regeneration by ion exchange

Achieved environmental benefits

Extension of the process solution life.

Cross-media effects

Eluates arising from ion exchange column regeneration have to be treated in waste water plants.

Applicability

This technique is applied in by-pass for the regeneration of process solutions, such as phosphoric acid pickling and chromium plating electrolytes. It is essential when using Cr(III) electrolytes (see Section 2.5.3) although control may be more difficult than for other ions. Selection of the correct resin is essential.

Metal pollution in process baths can be removed by using acid cation exchangers, e.g. chromium electrolyte: removal of Fe(III), Cr(III), Ni(II), Cu(II), Zn(II).

Example: Chromic acid passivation after zinc plating. After weeks of working, the bath contains Zn(II) which must be removed to increase the solution life. When the bath contains more than 15 mg/l of zinc it must be changed. Zn(II) can be removed using a cationic ion exchanger.

Economics

The technology is expensive and may not give payback for small installations. Na_2CrO_4 regeneration from passivation may not be economic.

Driving force for implementation

The technique is easy to integrate into the production process.

Example plants

In a Spanish installation, a cation exchange resin is used to treat a hexavalent chromium solution. The recovered chromium solution is then concentrated in an evaporator and returned to the solution.

Reference literature

[3, CETS, 2002] [120, Finland, 2003] [114, Belgium, 2003] [113, Austria, 2003] [114, Belgium, 2003] [129, Spain, 2003]

4.11.8 Electrolysis – purification of process solutions

Description

Some metallic contaminants can be removed selectively from electrolytes at low current densities from 0.05 to 0.3 A/dm². The efficiency of this selective cleaning can be enhanced with increased electrolyte throughput.

Achieved environmental benefits

Extension of process solution life.

Cross-media effects

Operational data

Not only unwanted metals, but also unused organic additives can be removed. Therefore electrolytic purification may be reduced to a minimum or compensatory additions of organic process materials may be necessary.

Reference literature

[3, CETS, 2002]

4.11.9 Electrolysis – removal of surplus metal from process solutions

Description

Metal process solutions where there is a higher anode yield than required in solution (such as zinc and nickel) suffer from increasing metal concentration leading to over-plating. The concentration can be lowered by electrolysis – usually called plating out, see Section 4.8.2. A typical system for maintaining nickel solution is shown in Figure 4.26, with activated carbon to remove organic contaminants as well as electrolysis.

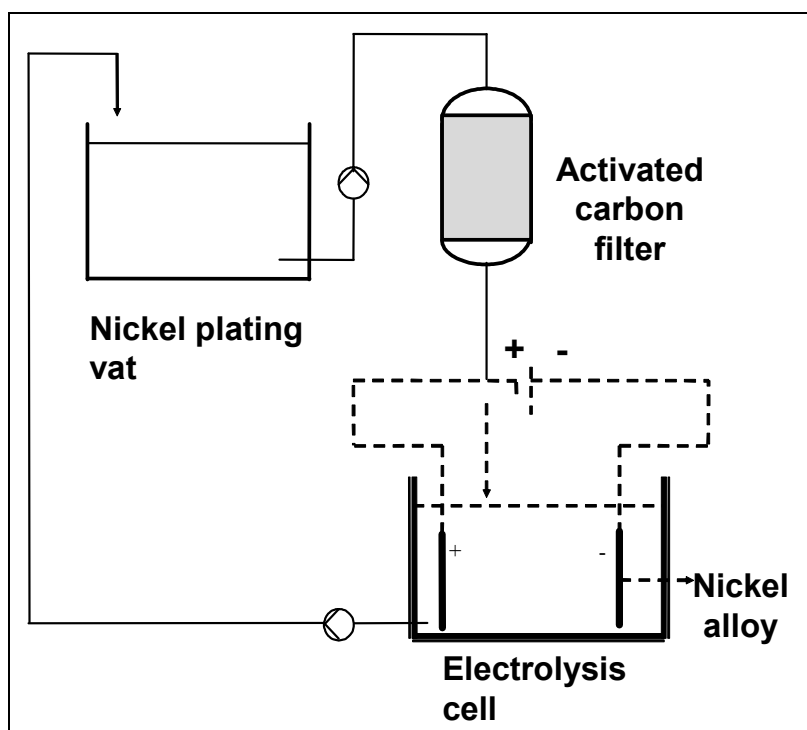

Figure 4.26: Electrolytic removal of surplus and contaminating metals

Achieved environmental benefits

Reduction of reworking.

Minimising dissolved metal drag-over into rinses.

Cross-media effects

Unwanted metal in solution increases dragged-out quantities.

Operational data

High anode yield can be better controlled by using insoluble anodes and external metal dissolution, see Section 4.8.2.

Applicability

Zinc and nickel electroplating with soluble anodes.

Driving force for implementation

Process control and minimisation of reworking.

Reference literature

[104, UBA, 2003]

4.11.10 Electrolysis – reoxidation of breakdown products**Description**

Chromium/sulphuric acid pickling of ABS plastic items oxidises and dissolves the butadiene component of the substrate, simultaneously generating trivalent chromium. Both the organic decomposition product and the trivalent chromium will disturb the process if a tolerable concentration level is exceeded.

It is possible to oxidise trivalent chromium without a membrane but with adequate anodic and cathodic density conditions.

Ceramic membrane electrolysis is the more reliable means to continuously regenerate process solutions, see Section 4.11.9.

Achieved environmental benefits

Extension of the process solution life.

Applicability

Chromium/sulphuric acid pickling of ABS plastic items.

Driving force for implementation

Product and process quality.

Reference literature

[3, CETS, 2002] [129, Spain, 2003]

4.11.11 Membrane electrolysis for chromium solution maintenance**Description**

Membrane electrolysis uses one or more ion-selective membranes to separate electrolyte solutions within an electrolysis cell. The membranes are ion-permeable and selective. Cation membranes pass cations such as Cu and Al, but reject anions. Anion membranes pass anions, such as sulphates and chlorides, but reject cations.

Membrane electrolysis can regenerate process solutions through two primary mechanisms:

- (1) Selective transfer of ions from the process solution, across the membrane, into an electrolyte solution and
- (2) Regenerating oxidation states/ionic forms of key constituents in the process solution through electrode electrochemical reactions.

A common configuration for removing cation contaminants from surface finishing process solutions uses a cation specific membrane coupled with a two-cell compartment drawing an electrical potential applied across the membrane. One cell contains an anode with the anolyte solution; the other contains a cathode with the catholyte solution.

The anolyte solution is typically the spent process solution requiring regeneration. Contaminant cations are removed from the anolyte solution and transferred into the catholyte solution. Anode and cathode reactions occur based on the relative electro-negativity and concentration of specific ions in each solution, as water decomposes.

An electrolytic cell technique with fluidised bed technology and used in conjunction with semi-permeable membranes extends the life of a hexavalent solution by 300 to 400 %.

Achieved environmental benefits

Reduces chemical usage.
Extends solution life.

Cross-media effects

Low power consumption.
Hazardous fumes may be emitted depending on solution (see Operational data, below).

Operational data

The membrane life depends on the conditions but can be more than a year.

Limitations of membrane electrolysis:

- special materials of construction and cell configurations may be required for processing
- highly corrosive fluids
- fume collection and treatment may be required if hazardous gases are generated in electrode reactions
- anionic metal complexes require pretreatment prior to removal across a cation exchange membrane
- operating temperatures are typically limited from 15°C to 60°C
- oil, grease and solvents can adversely affect membranes
- suspended solids and precipitates can clog membranes.

Membrane electrolysis systems can be configured as multi-cell systems to enhance capacity. Three compartment cells are used for special applications where the electrodes must be isolated from the feed stream. A range of selective and custom-made electrodes are available for removal of special and noble metals.

Applicability

Membrane electrolysis has been used with chromic acid based solutions, including chromium plating, chromic acid anodising, etchants and chromating solutions. Trivalent chromium can be beneficially deoxidised at anodes to hexavalent chrome. Contaminant metals are transported into the catholyte. Membrane electrolysis has also been applied to various acid-based etchants, stripping and pickling solutions to remove contaminant metals. Multi-cell systems with special anolyte and/or catholyte solutions have been used with highly corrosive acids, such as nitric and hydrofluoric, to isolate the electrodes. Membrane electrolysis can be used on a batch or continuous basis, and is often configured as a mobile unit for smaller point source applications.

Economics

Typical plant costs are EUR 15000 for the unit with annual operating costs of EUR 300.

Driving force for implementation

Materials and cost saving.
Process and quality reliability.

Example plants

BAe Systems plc, Balderstone, Lancs, UK

Reference literature

[110, BEWT, 2003]

4.11.12 Cleaning and regeneration of phosphate solutions**Description**

See Sections 2.5.16 and 2.9.8.9.

Spent phosphate solution is filtered; the concentrations in metallic ions and the pH are adjusted. The regenerated phosphate solution is re-used.

Achieved environmental benefits

Environmental benefit is high. Reduces the consumption of chemicals, reduces water and sludge releases.

Cross-media effects

None.

Applicability

New and existing plant, provided space is available.

Economics

Investment costs are EUR 0.015 to 0.8/t installed and operating costs are EUR 0.001 to 0.15/t.

Driving force for implementation

Process efficiency primarily.

Example plants

In several continuous electroplating lines in EU-15.

Reference literature

[19, Eurofer, 2003]

4.11.13 Maintenance of degreasing solutions

Table 4.15 summarises the techniques described in this section that may be used to maintain and extend the lives of degreasing solutions.

Technique	Uses and comments	Reference
Simple methods: Filtration with cellulose filters	Low cost for low volumes, widely applicable	4.11.13.2
Mechanical separation		
Gravity separation	Higher cost, but still widely applicable.	4.11.13.2
Breaking emulsion by chemical addition		
Static separator	Reduction in COD of effluent up to 50 % Extends solution life 50 - 70 % Simple in use and monitoring High cost: only applicable to high volumes of oil	4.11.13.3
Biological degreasing/regeneration	Used for weak alkali and/or unstable emulsions. Cheap and effective. May not work for all oils/greases.	4.11.13.4
Centrifuging degreasing baths	98 % removal of oil Low servicing Use in restricted space High cost: only applicable to high volumes of oil	4.11.13.5
Membrane filtration	COD load in effluent reduced 30 - 70 % Up to 10-fold increase in bath life High cost: only applicable to high volumes of oil	4.11.13.6
Multistage	Cost varies according to options combined	4.11.13.7
Electrolytic degreasing	Any of the same techniques as above	4.11.13.8
Cascading or re-using	Re-use or cascade the electrolytic cleaner to the soak clean vat.	4.11.13.1

Table 4.15: Techniques for degreasing solution maintenance

4.11.13.1 Cascade (multiple) use of degreasing solutions

Description

One technique for extending the working life of degreasing solutions is to re-use the solution, or use it in a cascade fashion. The solution from the electrolytic degreasing section is re-used once a certain oil level is reached, either in the spray section of coil lines, or in the first degreasing section of other lines. The spent degreasing solution of the spray section can be regenerated.

Achieved environmental benefits

Significant reduction in electrolytes and water consumptions within the processes and hence a reduction in the quantity of waste water volumes.

Applicability

New and existing plant, provided space is available.

Not applicable where specific solutions are used for the electrochemical degreasing (e.g. highly alkaline with high conductivity) and the precleaning (e.g. good oil solubility).

Economics

For coil systems, investments costs are EUR 0.015 to 0.8/t installed and operating costs are EUR 0.001 to 0.15/t.

Driving force for implementation

Process efficiency primarily.

Example plants

In several continuous electroplating lines in the EU-15

Reference literature

[19, Eurofer, 2003]

4.11.13.2 Simple methods**Descriptions of typical simple methods**

Simple filtration with cellulose filters, see Section 2.7.1.

Mechanical separation by skimmers.

Gravity oil separators working in by-pass separate oil/grease by allowing agglomeration of small droplets of oil to larger globules which float to the surface and are then removed. This may be enhanced by dissolved air flotation.

Separating emulsified oil by breaking down the emulsion. The easiest route is by chemical addition which splits the wetting agent system and releases the oil, at the same time destroying the degreasing effect.

Achieved environmental benefits

All methods remove oil and extend the working life of degreasing solutions.

Cross-media effects

Energy consumption for skimmers and for dissolved air flotation.

Chemicals used for demulsifying.

Cellulose filters have to be discarded periodically, increasing waste.

Operational data

Gravity separation is the lowest maintenance system.

Applicability

All degreasing solutions, depending on solution life, and investment costs.

Economics

Mechanical separation by skimmers is the simplest and cheapest method of removing floating oil from the cleaner surface.

Driving force for implementation

Improved cleaning results in improved performance and reliability of subsequent surface treatments. This in turn decreases rejects and reworking.

Reference literature

[129, Spain, 2003]

4.11.13.3 Static separator for degreasing baths**Description**

Using a static separator (where the used degreasing bath is pumped by batch or continuously) is a simple technique to increase the bath life, although baths may need active ingredients adjusting to keep their efficiency. Physical separation by the difference in density between two phases allows the separation of the oil-water mixture. This separation is made by natural decantation of the separated oil in a separate tank off-line or by a mechanical system using a scraper or oleophilic drum or belt skimmers on the surface.

Achieved environmental benefits

Large fall of the COD in the effluents, by 50 % in some cases.

Significant reduction in dumping of used solutions: in most cases reduction of between 50 and 70 %.

Reduction of detergent purchases by 50 %.

Cross-media effects

This process is less selective and also less expensive than techniques using membranes. The recuperated oils are usually polluted and therefore destroyed.

There is only elimination of the floating layer, with just a small fraction of the emulsions discarded.

Operational data

This technique is very simple (there is no membrane). Monitoring is very simple.

The pollution in the degreasing bath is maintained at a constant low level, reducing the level of drag-out and minimising the use and pollution of rinsing water.

Eliminates the floating oils which represent the main pollution of a bath.

Decreases problems with waste water treatment by decreasing flocs and sludges coming from hydrocarbons, and batch discharge of high pHs.

Very fine dispersions (emulsions, micro emulsions, COD) and soluble oils are not readily separated. The polluted species concentration will increase in the bath and it will be necessary to discard the solution or make additions of surface active agent.

Applicability

Best used with weak emulsion degreasing solutions, see Section 4.9.14.4

Economics

This is an inexpensive technology, depending on the size and sophistication of the technique applied. At its most basic, it will comprise a separate tank, with pump, and pipework. Costs can be up to EUR 50000 for a more complex system.

Driving force for implementation

High throughput through degreasing process.

Strong demand for high quality and consistent degreasing.

High cost of rejection and reworking.

Example plants

In France: Berezecki (Beauvais), Kerbério (Gretz Armainvilliers), Berthollet (Montreuil)

Reference literature

[57, France, 2003]

4.11.13.4 Biological degreasing regeneration

Description

Although often referred to as a degreasing system, it is a maintenance system for weak alkali degreasing baths. Its constant bypass regeneration of the bath by degrading the oil biologically overcomes the limitation of the weak alkali bath: the accelerated exhaustion of its dissolution capacity compared with strong alkali/stable emulsion systems. A typical layout is shown in Figure 4.27, although simple systems with manual additional of additives also work well.

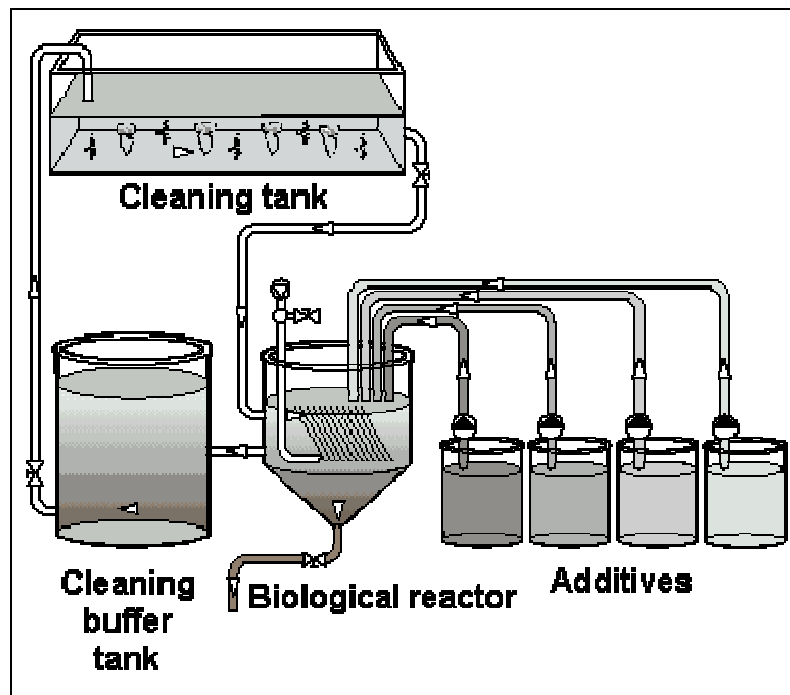

Figure 4.27: Biological aqueous degreasing process
[3, CETS, 2002]

Workpieces/substrates are placed in the process solution consisting of mildly alkaline emulsifying cleaners. In this case, the operating temperature is lower (approximately 45 °C). The ingredients include a surfactant to lift and emulsify dirt and oil from the surfaces, naturally occurring micro-organisms to degrade the oils to carbon dioxide and water, and nutrients for the micro-organisms. Air is bubbled into the solution at a low rate to ensure the system stays aerobic. The solution is continuously circulated through a side tank, containing the micro-organisms, where additions of nutrients and other process chemicals are made and the solution continuously regenerates itself, with the occasional removal of small amounts of sludge from the side tank.

There are several variants of this general type of biological degreasing process. In some applications, the degreasing bath itself is used as a bioreactor and the workpieces to be degreased are immersed into this solution-containing biomass. It can be operated as a two-stage process with normal alkaline aqueous degreasing as a pre-degreasing stage followed by a combined biological degreasing/rinsing stage where the bath itself is also the bioreactor.

Achieved environmental benefits

Runs at more neutral pH, with lower operating temperatures of around 45 °.

Reduced use of process chemicals as the solution rarely needs replacement.

Reduction in use of hazardous chemicals in the workplace.

Reduced usage of neutralising chemicals when discharging used process solution and lower impact of surfactants on effluent treatment.

Lower evaporation losses therefore less need to extract water vapour.

Cross-media effects

Possible growth of legionella bacteria and regular testing may be required.

Operational data

Reduces downtime of production line to replace spent solutions.

Ensures consistent quality of degreasing versus changing quality of chemical degreasing with a short service life

Some operators report the process may not be suitable for all oils and greases (possible problems with oils containing sulphur compounds).

In some applications, the biomass in the degreasing solution can be partially carried over into the following process stages, causing quality problems to the following surface treatments. Processes which combine a bioreactor with membrane separation are currently under investigation to overcome the problem of the limited efficiency of lamella separators [124, Germany, 2003].

The biological system can break down if only small amounts of biotoxic substances like cyanide, copper, AOX, etc. are dragged into the solution. The system does not work with some polishing pastes, which may also be biotoxic.

The right choice of surfactants is important. They need to be – at least partially – resistant against microbial degradation.

The system requires a continuous supply of oil, or extra feeding if downtime is more than three days.

The system does not give good cleaning quality if soaking in high temperatures is needed (for example, with polished pieces).

Applicability

See Operational data, above. It is advisable to test all the likely applications (types of work piece, types of oil/grease coating etc) before using on a full scale. Sufficient installations are using this technique commercially for it to be considered.

Economics

One operator reports chemical savings of EUR 6000 – 7000 per year (2002) on two 50 kg barrel lines.

Another operator reported chemical savings of EUR 3400 per electroplating line first year savings and EUR 3800 per year per line thereafter (1999).

A medium sized contract electroplating company reported a 15 - 25 % reduction of specific treatment costs for the degreasing/rinsing/pickling stage when substituting a conventional aqueous hot alkaline degreasing process by a biological degreasing process.

None of these figures include savings in water, energy, labour in reduced solution make-up time, increased efficiency (line downtime) and improved process performance (with less rejects).

Driving force for implementation

Reduces process line downtime for degreasing solutions to be changed.

Reduces the amounts of hazardous chemicals in use in the workplace (replaces strong caustic and surface active solutions).

Reduces sludges from the waste water treatment from cleaning by 80 %.

Reduced costs.

Example plants

Dundee Electroplating Ltd, Dundee, UK; Exhall Plating Ltd, Coventry, UK; Merrydale Industries Ltd, Wednesbury, UK; Metal Colours Ltd, Slough, UK, Sessler Galvanotechnics, GmbH, Germany, See Annex 8.5

Reference literature

[18, Tempany, 2002, 31, Biowise, 2001] [124, Germany, 2003] [115, CETS, 2003] [113, Austria, 2003] German Federal Ministry of Education and Research report 01RW0189

4.11.13.5 Centrifuging of degreasing baths

Description

Centrifuging cleans the degreasing baths by separating oils. The polluted degreasing solution is pumped to a centrifugal separator. The oil is removed and collected for recovery separately to the solids and sludge produced. The clean degreasing solution is then returned to the degreasing bath.

Achieved environmental benefits

This process reduces the discarding of used baths contaminated with oil and solids. The pollution in the degreasing bath is maintained at a constant low level, reducing the level of drag-out and minimising the use and pollution of rinsing water.

Oil is recovered and concentrated at the output of the separator for possible recovery. Sludges are collected separately.

Reduction of the draining frequencies (between 30 and 80 %) according to the size, the production and many other parameters relative to the installation, with less heating and downtime required.

There is no loss of surface active agent.

Cross-media effects

Electrical power for pumping and operating the centrifuge.

Operational data

The bath purification is higher than 98 %. According to a supplier, the residual oil concentration is less than 2.5 g/l.

Drag-out is reduced; the following rinsings are less polluted so the treatment quality increases.

Limited servicing and maintenance (once every 2000 hours for automatic machines).

Centrifuging makes it possible to eliminate a large amount of oil in a restricted space.

The machines used can be mobile and can be used to treat baths of different origins.

It is very useful when the sedimentation speed of particles is very low.

Manual machines are sensitive to fouling by sludges and must be reserved for baths with a relatively low sludge content. The maintenance of manual machines which have not been sufficiently protected from sludges can be tedious.

Sometimes surface active agents must be added to maintain the bath efficiency because oil in the micro-emulsion is not separated from the aqueous phase.

Applicability

The chemistry of the surface active agents must be adapted. Centrifuges cannot treat very acid baths (pH <2).

Economics

It is a very expensive form of technology which costs at least EUR 50000 and can reach over EUR 150000 when installation, the storage and collection of baths is included.

Driving force for implementation

High throughput through degreasing process.

Strong demand for high quality and consistent degreasing.

High cost of rejection and reworking.

Example plants

In France: Renault (Flingues, Cléon) Chan-t'eu et Maury (Lucé) Freudienne (Langres) Noiraud (Laon), Ronéo (Noyon)

Reference literature

[46, France, 2003]

4.11.13.6 Membrane filtration of emulsifying degreasers (micro- or ultrafiltration)

Description

This technique can be used where, for technical reasons, the use of strongly emulsifying degreasing systems are necessary, and the regeneration of the cleaning solution by other methods may become expensive or even impossible.

Membrane filtration technology, particularly micro or ultrafiltration is a process of physical separation using membranes for the separation of particles from 0.005 to 0.1 micrometers (the separation of smaller particles is by nanofiltration or reverse osmosis). There is a small difference in pressure so that the liquid moves from one side of the membrane to the other.

Filtration is tangential, so that the fluid circulates in parallel with the membrane, rather than the traditional filtration which is perpendicular or frontal (therefore loading particles onto the filter). Tangential filtration allows the accumulation of fouling particles without fouling the filtration surface. The liquid crossing the membrane is the filtrate or permeate and is a clean solution containing purified detergent solution that is fed back in the degreasing bath. The solution unable to cross the membrane is the retentate, containing oil and suspended material. A typical system is shown in Figure 4.28.

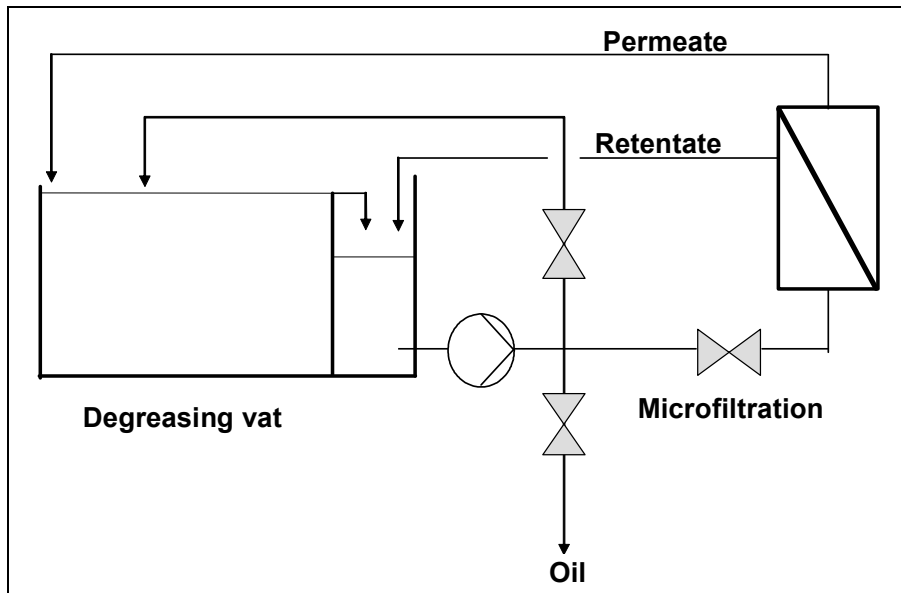

Figure 4.28: Bypass microfiltration for extending the service lifetime extension of a degreasing solution

Achieved environmental benefits

Reduced chemical and energy consumption in degreasing heavily contaminated workpieces or substrates. Increase of the degreasing bath lifetime (up to 10 times). Reduction of detergent consumption by 50 %

High reduction in pollution, reducing COD between 30 and 70 % according to water agency data. There is less discarding of the used baths (usually with oil levels between 10 and 15 g/l).

Cross-media effects

Power consumption of pumping to microfiltration, although with tangential filtration the costs will be lower than for a perpendicular system.

Operational data

The surfactant components may also be lost by permeating through the membranes, and for the successful use of microfiltration, the composition of the chemicals in the cleaner must be maintained.

The oil concentration in the bath decreases to 2 or 3 g/l and is held constant depending on the filtering rate. The bath is filtered continuously, and with the constant efficiency of the degreasing bath (between 500 and 800 microns), there are fewer problems of fouling when used with spraying systems.

The choice of membranes have to be determined by tests, as there is a possibility of fouling during use.

Applicability

Only a few operators have successfully retained the cleaning quality in practice over longer periods. For this reason, the successful employment of the diaphragm cleaning system for degreasing solutions requires the close co-operation of operators, equipment manufacturers and chemical suppliers.

The cost effectiveness success of this technique is based on using the membrane best suited to the wide range of pollutants encountered in a degreasing bath. Most of the equipment is installed in in-house shops where the composition of oils to be removed is more constant.

Economics

Energy cost: electric consumption between 0.10 and 0.20 kWh per m³ treated.

No draining down of hot used baths so less waste of heating energy.

No need to stop production to change degreasing baths.

The investment is relatively expensive. The cost of the ultrafiltration installation depends on the particular situation of the company (volume vats, degreasing quality, quantity of oil to eliminate, etc.). This cost is estimated between EUR 40000 and 200000 including the total price of the ultrafiltration unit (membranes, storage of the ultrafiltrate and, in some cases, installation of connection).

Driving force for implementation

Where heavily oiled/greased components require a strongly emulsifying degreasing system.

High throughput through degreasing process.

Strong demand for high quality and consistent degreasing.

High cost of rejection and reworking.

Example plants

In France: Renault (Sandoval, Clean), Renault Trucks (Plainville), Sausage Production Service (Pont Saint Maxine), STILL (Minatare), Sachs Aliquant (Mousy), Ago France (Beavers).

Reference literature

[3, CETS, 2002, 104, UBA, 2003] [19, Eurofer, 2003] [59, France, 2003] [121, France, 2003].

4.11.13.7 Multistage maintenance of degreasing solutions

Description

Multistage systems use a simple method removing the majority of oil and/or grease followed by diaphragm filtration. For example, gravity filtration followed by ultrafiltration.

Achieved environmental benefits

All remove oil and extend the working life of degreasing solutions.

Cross-media effects

Energy consumption for skimmers, dissolved air flotation or any other primary treatment, as well as in pumping for subsequent diaphragm filtration.

Chemicals used for demulsifying.

Operational data

Improved process reliability both of cleaning and subsequent treatments.

Gravity separation is a simple system requiring low maintenance.

Applicability

Where large amounts of oil and grease are present on incoming workpieces or substrates, where process line throughput is high, and/or where the quality of degreasing is highly critical to the following treatments.

Economics

The size of subsequent (and possibly expensive) stages, such as ultrafiltration or mechanical separation by skimmers can be reduced by pretreatment by simple techniques (see 4.11.13.2 such as gravity separation (the simplest and cheapest simple method).

Driving force for implementation

Improved cleaning results in improved performance and reliability of subsequent surface treatments. This, in turn, decreases rejects and reworking.

Reference literature

[104, UBA, 2003]

4.11.13.8 Maintenance of electrolytic degreasing processes

The same processes used for alkaline cleaners can be applied for electrolytic cleaners, taking into account that the quantity of oil removed is small compared with that removed in soak cleaning.

4.11.14 Pickling

Pickling solutions lose activity by the dissolution of metals [124, Germany, 2003] as well as the constant entry of rinsing water from the previous process stage, so they must be renewed at relatively short intervals. At present, no techniques exist in practice to extend the service life of pickling solutions, although two-stage or drag-in through a used pickling solution may be considered (see Section 2.3.6).

The prevention of over-pickling is important. Over-pickling is the attack of the pickling solution on the basis metal, and in surface technology is an unwanted side effect, as it:

- leads to increased acid consumption with increased metal erosion and thus also increasing waste generation (from the dissolved metal being precipitated in waste water treatment and the increased amount of waste acid generated)
- causes substantial quality losses in the base material (hydrogen brittleness)
- can degrade the quality of the workpiece surface and/or change the geometrical measurements of the workpiece adversely.

Over-pickling can be prevented by the addition of so-called pickling inhibitors which are widely used [104, UBA, 2003].

4.11.14.1 Measures for decreasing pickling acid consumption

Description

A three-stage cascade hydrochloric acid system running at 0.5 l/min is being used successfully to remove hardening scale from parts prior to plating. The system is identical to a cascade water rinse system, but uses 32 % hydrochloric pickling acid instead of water.

Achieved environmental benefits

Extending chemical process life. A three-stage cascade system has reduced chemical usage by 50 % (the Example plant, see below, reported a drop from two tonnes to one tonne per day of 32 % hydrochloric acid).

A smaller, continuous flow of hydrochloric acid is more readily treated in a typical waste water treatment plant, removing the problems caused by batch discharges of acid to treatment.

Operational data

Substantial reduction in rejects, as the strength of the acid through the cascade system remains constant and effective, unlike 'batch treat and dump' systems, where acid strength decreases constantly until replaced.

May require more process stages in line, and these will be in the most corrosive part of the line.

Applicability

This is applicable where some or all of the following apply:

- pickling acid consumption is considerable
- pickling of parts is on a large scale
- quality of pickling is a problem, such as surfaces to be treated are resistant to pickling (e.g. hardening scale, which require a constant supply of fresh acid)
- batch acid discharges from pickling to waste water treatment adversely affect the treatment.

Economics

Cost savings in materials offset the increased amount of plant required for multistage pickling. Reduced rejects, see Operational data, above.

An example calculation for changing from three-stage static pickling to cascade rinsing is given in Annex 8.11.

Driving force for implementation

For multistage pickling, increased process stability, decreased rejects and cost savings.

Example plants

Metal Colours Ltd, Slough, UK

Reference literature

[18, Tempany, 2002, 104, UBA, 2003] [124, Germany, 2003]

4.11.14.2 Extension of the service life of pickling solutions by diffusion dialysis

Description

If the concentration of the metal salts in the pickling solution, formed by dissolution, becomes too high, no more pickling effect can be achieved even with further addition of acid. At this point, the pickling bath is useless and is usually discarded. Further use of the pickling solution is possible only by selective separation of the dissolved metal salts.

Diffusion dialysis separates acid from its metal contaminants via an acid concentration gradient between two solution compartments (contaminated acid and deionised water) that are divided by an anion exchange membrane, see Figure 4.29. Acid is diffused across the membrane into the deionised water whereas metals are blocked due to their charge and the selectivity of the membrane. A key difference between diffusion dialysis and other membrane technologies such as electrodialysis or reverse osmosis is that diffusion dialysis does not employ an electrical potential or pressure across the membrane. Rather, the transport of acid is caused by the difference in acid concentration on either side of the membrane. As such, the energy requirements for this technology are low.

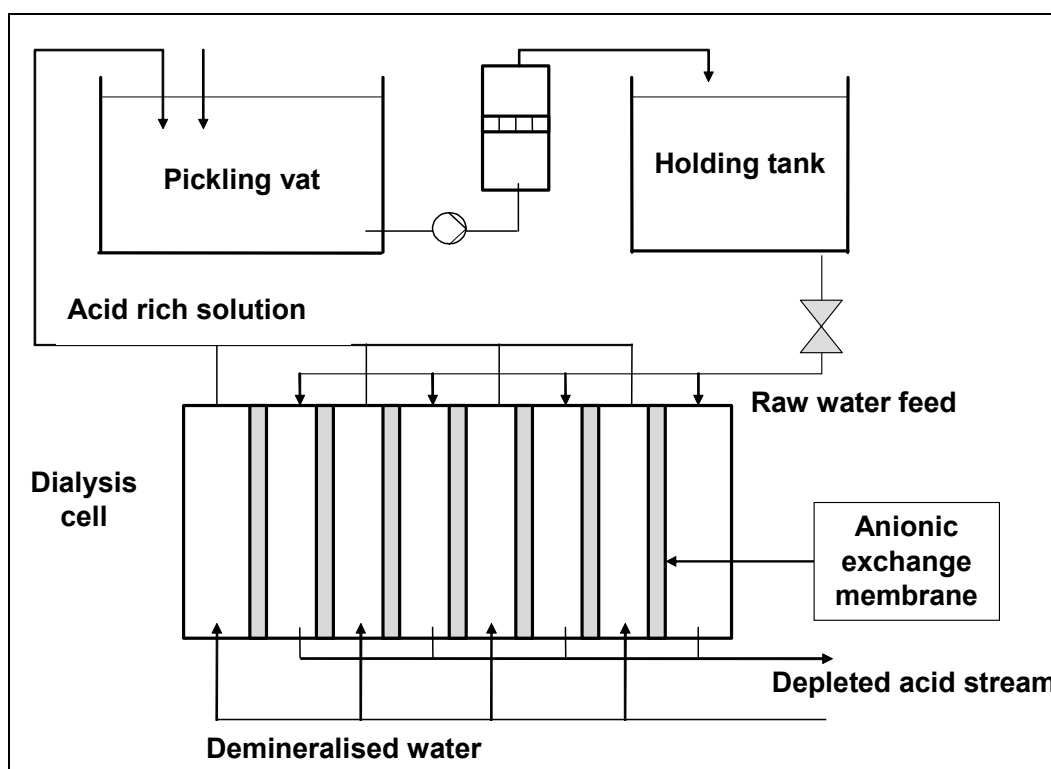

Figure 4.29: Regeneration of pickling solutions by dialysis

Separating integral parts	Parameters	Feed		Emissions	
		Etching solution	Water	Diffusate	Concentrate
	Flowrate (l/h)	830	830	700	960
HCl, AlCl ₃	HCl (g/l)	100		85	25
	AlCl ₃ (g/l)	30		0.7	26
	Flowrate (l/h)	20	20	14	26
H ₂ SO ₄ , NiSO ₄	H ₂ SO ₄ (g/l)	32		27	12
	Ni (g/l)	1.7		<0.04	1.6

Table 4.16: Results of the dialysis treatment on etching solutions

Achieved environmental benefits

Extension of service life of the chemical process solution. Achieved concentrations are shown in Table 4.16.

Lower power consumption than techniques using pressure

Cross-media effects

The concentration of recovered acid will normally be lower than that of the feed acid, and make-up acid must be added to bring the concentration up to the process level. When the feed has a significant salt concentration, the concentration of recovered acid can exceed the concentration of the feed acid.

The depleted acid waste stream (after diffusion dialysis processing) is approximately equal in volumetric flow to the waste acid influent. Depending on the application-specific acid removal and metals rejection rates, the depleted acid waste stream (retentate) typically contains 5 to 20 % of the acid and 60 to 95 % of the metals from the influent waste acid stream. This stream is usually sent to waste water treatment.

Operational data

To prevent mechanical blocking, pickling acids must be pre-filtered before using dialysis.

For diffusion dialysis processing, an increase in membrane area per unit of acid flow increases the acid recovery rate. If the flowrate of DI water increases, the acid recycling rate increases and the recycled acid concentration decreases.

Diffusion dialysis systems can be used for batch or continuous flow applications. Small systems are often configured as mobile units.

Limitations in using diffusion dialysis to recover surface finishing process acids include:

- acids not highly dissociated (e.g., phosphoric acid) will not diffuse across the membrane
- complexed metal anions (e.g., fluorotitanium anions) can readily diffuse across the anion exchange membrane and are not efficiently separated from the acid.

Cooling is typically needed if influent waste acid temperature exceeds 50 °C.

Heating may be needed for low temperature influent waste acid. A temperature drop of 2 °C reduces the acid recycling rate by approximately 1.5 %.

Solvents can cause membrane swelling.

Strong oxidising substances (e.g., chromic acid) can cause membrane deterioration.

Applicability

Diffusion dialysis is a purification/recycling technology that can be used to maintain or reclaim spent or contaminated acids where acid concentrations are greater than 3 % by weight. Diffusion dialysis is most typically used where contaminant metals concentrations are less than 1 gram per litre. Surface finishing process solutions amenable to the use of diffusion dialysis include:

- hydrochloric acid (HCl) pickle and strip solutions
- sulphuric acid (H₂SO₄) anodising solutions
- sulphuric acid pickle and strip solutions
- nitric acid (HNO₃) pickle and strip solutions
- nitric acid/hydrofluoric acid (HNO₃/HF) stainless steel pickling solutions
- hydrochloric acid/sulphuric acid (HCl/H₂SO₄) aluminium etch solutions
- methane sulphonic acid (MSA) solutions.

Economics

Diffusion dialysis may be expensive in capital and running costs for simple applications, and complex to run. The most cost-effective use for it may be, for example:

- where there is significant use of the more expensive and/or concentrated acids (e.g. phosphoric)
- in expensive etching techniques such as methyl sulphonic acid used with tin and tin/lead.

Driving force for implementation

Process consistency and quality.

Reduction in fresh acid, waste acid treatment or disposal costs.

Reference literature

[104, UBA, 2003], [154, NMFRC,] [129, Spain, 2003, 159, TWG, 2004, 162, USEPA, 2000]

4.11.14.3 Recovery of copper from pickling baths

Description

In pickling baths for copper (non-ferrous metals), copper can be recycled by simple electrolysis (see Section 4.12.1 for discussion) [113, Austria, 2003]

4.12 Recovery of process metals

This refers to recovery systems within installations, not to external processes.

4.12.1 Electrolytic recovery

Description

Metals may be recovered by electrolysis. The system is widely used for precious metal recovery, but can also be used to recover other metals such as nickel and chromium from drag-outs. Suitable electrolysis cells are marketed in different sizes and can operate down to metal contents of less than 100 mg/l.

May be operated in conjunction with other techniques to achieve low emission levels for water, or recycling of rinse-waters, etc, see Section 4.7.12

Achieved environmental benefits

Recovery of metals for re-use.

Reduction of metals in drag-out and their consequent decrease in effluent concentrations.

In the electrolytic separation of metal solutions containing cyanide, the anodically oxidative destruction of the cyanide takes place in parallel to the metal winning.

Cross-media effects

Power consumption at low current efficiencies.

Operational data

Precious metals electrolytic recovery requires the electrolytic reactor to be able to reduce the metal concentration down to a very low concentration (1 ppm or less). The current efficiency at this level is very low. In all cases, a simple flat plate cathode would be sufficient in theory, but when high current efficiencies are required (for both precious and transition metals) sophisticated cathode design is needed (rotating tube cell, graphite fibre cathode), or a fluidised bed to overcome cathode surface depletion (see Figure 4.30). In all cases (including anodic oxidation) the anode must be of the 'insoluble' type.

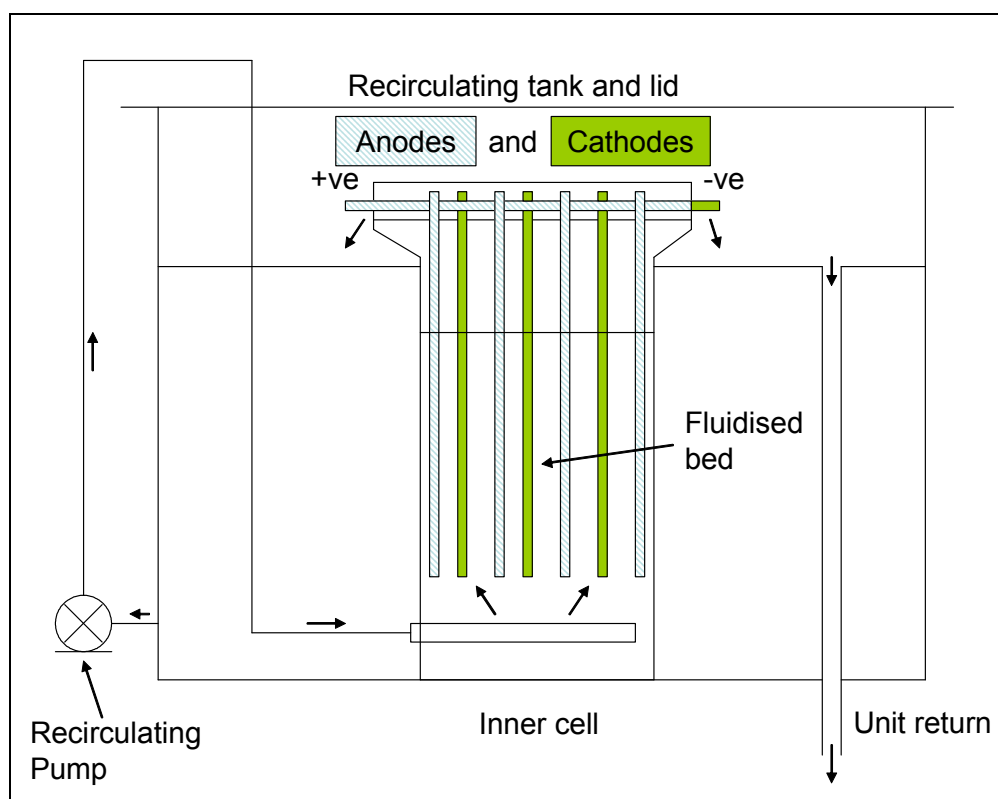

Figure 4.30: Optimised cell using fluidised bed technology
Chemelec cell, BEWT Environmental Services Ltd.

Cathodes are usually sheets, foil or particles, generally made of the same metal to be recovered, but also of stainless steel or other metals, which allow either a mechanical parting of the deposit from the cathode blank, or its removal by anodic dissolution. Iron, stainless steel, porous carbon, graphite particles, glass or plastic metallised beads and metallised fabrics are all examples of common materials used. Cathode material selection is largely determined by the nature of the treatment, which follows the metal deposition. In any case, maximising both the cathode surface area and the diffusion process are the most important means to enhance the efficiency of the electrolytic reactor.

Anodic material includes: graphite, lead, lead alloys with antimony, silver or tin, stainless steel, cast iron, ferro-silicon and the valve metals (titanium, tantalum, tungsten, niobium) coated with noble metals (platinum iridium) or with noble metal oxides (iridium, ruthenium oxides).

Anodic material selection is usually a compromise based on:

- over-voltage behaviour for the particular reaction on a given material
- anode corrosion, mechanical properties and the form in which the material is available
- price.

Operating conditions vary as a function of the metal to be recovered; for gold the recommended conditions are: pH minimum of 10, cell voltage 8 V, current density 20 A/dm², temperature >60 °C, and an anode-cathode gap from 8 to 16 cm.

Further advantages of the electrolytic recovery over the ion exchange method are:

- it does not produce any increase in the dissolved salt concentration
- the presence of other metals in similar concentrations does not affect the rate of removal of the desired species
- may also oxidise unwanted species, such as cyanide

Noble metals, because of their electropositive character, are more readily electrodeposited than non-noble ones.

For electrolytic metal recovery, the following streams are particularly suitable:

- rinsing (drag-out) concentrates from electroplating metal
- rinsing (drag-out) concentrates and used process solutions from chemical metal plating excluding solutions-containing phosphate
- sulphuric acid regenerates of cation exchangers from the treatment of rinsing waters: these contain non-ferrous metals.

The purity of the generated metals may permit a direct in-house use as an anode material, otherwise re-use is via the scrap metal trade.

Applicability

Gold and silver have been recovered electrolytically for well over 50 years.

Electrolytic recovery has wider applicability than precious metals: it can also be used for transition metals, see reference plants in Annex 8.5 and Example plants, below.

Fluidised bed cells increase the process efficiency.

Economics

Cost-effective for precious metals.

Can be cost-effective for transition metals, for example, where it reduces the waste water treatment costs (capital and running costs).

In-house electrolysis has costs in investments and personnel (both time and skills) as well as a substantial energy expenditure because of the low electricity yield (kg/amp hour). This may be offset for cyanide solutions where the cyanide is destroyed in parallel.

For a- fluidised bed cell: although the technique can be utilised on most metals, economic considerations limit the application to either valuable or easily re-usable metals. Units can recover from 1 kg/week to 150 kg/week of electrolytically pure metal from solution. The solutions can be very dilute, typically containing 100 – 500 parts per million (0.1 – 0.5 gm/l). Typical costs are shown in Table 4.17.

Nominal capacity	Capital cost GBP	Typical operating cost/yr GBP
<1.5 kg/week	6500	<10
<5 kg/week	14000	115
<30 kg/week	24000	300
<150 kg/week	68000	800

Table 4.17: Typical capital and operating costs for a fluidised bed electrolytic cell

Driving force for implementation

See Economics, above.

Water pollution protection legislation and PARCOM.

Example plants

For nickel and chromium: Townrow (Hi-Tech Plating) Ltd, Sheffield, UK.

Gold, silver, rhodium, nickel, copper recovery; cyanide destruction; and water re-use: Marigot Jewellery (Thailand), Samutprakarn 10280, Thailand.

Copper Recovery (Printed Circuit Manufacturer): P.W. Circuits Ltd. South Wigton, UK.

Silver recovery from waste photographic solutions: Shannon Environmental Services Ltd., Shannon, Republic of Ireland.

Reference literature

[3, CETTS, 2002, 18, Tempany, 2002] [110, BEWT, 2003] [12, PARCOM, 1992]

4.12.2 Ion exchange – recovery of precious metals from rinses

Description

Precious metals in concentrated solutions are usually recovered electrolytically (see Section 4.12.1), while more dilute solutions, sometimes of no more than a few mg/litre, are treated by adsorption of the metal content on ion exchange resins.

Ion exchange provides only a concentration of the metal in the resin, the subsequent recovery being possible by incineration of the resin or by releasing the metal in dissolved form, but at higher concentration. The final metal recovery by incineration is in an oxygen-rich atmosphere at 500 – 600 °C; metals are found with the residual ash. Recovery is about 95 % efficient.

Achieved environmental benefits

Recovery of precious metals.

Cross-media effects

Emissions from incineration of the resin.
Increased salt concentrations in resin regeneration.

Operational data

For gold and precious metals, the principle of the method is based on treating the rinse-water with a strong basic type of anionic ion exchange resins, in the OH⁻ or in the Cl⁻ form. This does not work well for alkaline cyanide or chloride-based rinses. Ion exchange resins are quoted as having a useful capacity of 100 g of gold per litre of resin.

Typically the equipment consists of two ion exchange resin columns in series, with the first unit taking the main load, while the downstream column takes any excess. Each resin column needs to contain around four litres or more of ion exchange resin to be effective.

When very large volumes of rinse-water are used, an option is the treatment of the static rinse which workpieces pass through after the precious metal plating tank. The treatment is through a closed loop resin column. This ensures such a low gold concentration in the static rinse that further drag-out losses into the following cascade rinses may be neglected.

Silver recovery requires using weak basic anionic ion exchange resins, followed by regeneration and subsequent electrolytic recovery of the regenerate. Typically the resin capacity is in the range of 50 – 75 g of Ag/litre (silver per litre) of resin. A further option is the use of ion exchange units built into a recirculation rinse loop with periodical regeneration. Precious metal is then recovered by electrolysis from the concentrate. This has been successfully used for silver.

Palladium used in the PCB industry is recovered from acid solutions containing chloride (pH about 2), where it is present as a chloro-complex, using strongly basic ion exchange resins. The same process readily allows its separation from copper. The typical resin capacity (the same type of resin as used for gold) varies from 30 to 50 g of Pd per litre of resin.

Driving force for implementation

Cost recovery.

Reference literature

[3, CETS, 2002]

4.12.3 Chromating**Description**

The hexavalent chromium in chromating solutions is exhausted after a certain time. The solutions also dissolve and accumulate zinc and other metals and eventually lose their workability, and must then be rejected and renewed.

Numerous attempts have been made to regenerate chromating solutions, predominantly via ion exchangers or via diaphragm technology.

Achieved environmental benefits

Extended bath life and recovery of metal.

Cross-media effects

Energy and chemicals used in regeneration techniques.

Economics

Regeneration is usually only cost-effective with relatively concentrated and expensive solutions, for example, black chromating solutions containing silver.

New yellow chromating process solutions for zinc only costs EUR 3 to 4/100 litre (2002). This makes it difficult to recover the costs of capital, the energy expenditure and maintenance for the recovery measures.

Reference literature

[104, UBA, 2003]

4.12.4 Precipitation

See Sections 4.16 and 4.17.

4.13 Post-treatment activities – techniques relevant to the determination of BAT**4.13.1 Drying**

Options exist such as hot water drying, hot air, air knives. (No further data given).

4.13.2 De-embrittlement

Description

De-embrittlement is heat treatment carried out after certain processes to avoid the unwanted embrittlement caused by hydrogen being trapped in the crystalline structure of metal substrates. This occurs in pickling, cathodic cleaning, or the electrodeposition of metal where the current efficiency is less than 100 %, or by chemical deposition (phosphating). The temperature and time of the embrittlement process depends on the substrate.

Achieved environmental benefits

Cross-media effects

High energy consumption in heating.

Driving force for implementation

Work piece or substrate finish specifications.

Reference literature

[159, TWG, 2004]

4.14 Continuous coil – large scale steel coil

Many of the possible best available techniques used are described elsewhere in this document and cross-referenced. The techniques described in detail here are of particular relevance to coil coating and/or add specific information [19, Eurofer, 2003]. Costs given are per tonne processed.

4.14.1 Using digital process control

Description

Digital process control systems collect data and react on the processes in real time. See Section 4.1.5.

Achieved environmental benefits

Improved plant efficiency and product quality as well as lowering the emissions.

Cross-media effects

No

Applicability

New and existing plants

Economics

Initial investment is high: EUR >0.8/t installed, with high operating and maintenance costs of EUR >0.8/t.

Driving force for implementation

Process efficiency and quality requirements.

Example plants

Many continuous electroplating lines in EU-15.

Reference literature

[19, Eurofer, 2003]

4.14.2 Oil tight trays

Description

Leakage from hydraulic systems to soils, surface and groundwater is prevented through use of oil tight trays.

Achieved environmental benefits

Minimises the possible release of oil to land and water.

Applicability

New and existing plants

Cross -media effects

None.

Operational data

Improves operator health and safety, by reducing slippage on oily floors.

Economics

Initial investment is low EUR 0.001 – 0.15/tonne installed, with low operating costs 0.001 – EUR 0.15/tonne installed.

Driving Force for Implementation

Process efficiency.

Health and safety.

Example plants

Many continuous electroplating lines in EU-15.

Reference literature

[19, Eurofer, 2003]

4.14.3 Energy efficiency

4.14.3.1 Energy efficient motors

Description

See Section 4.4. the application of energy efficient motors where motors are used in the process.

Achieved environmental benefits

Reduction in energy consumption on the line.

Cross-media effects

None

Applicability

Can be used in new plant or as replacement parts

Economics

The initial investment is medium: EUR 0.015 – 0.8/t installed.

Operating costs are low EUR 0.001 to 0.15/t.

Driving force for implementation

Process efficiency.

Example plants

Many continuous electroplating lines in EU-15.

Reference literature

[19, Eurofer, 2003]

4.14.3.2 Raising the conductivity of the electrolyte

See Section 4.4.1.4.

4.14.4 Water efficiency

4.14.4.1 Re-cycling of quench waters

Description

To produce a bright finish on the product following flow melting in tin plating, the strip is cooled via a water quench. This water is recycled and re-used until it is disposed of when there is too high a build-up of tin. See Section 4.4.5.

Applicability

To new and existing plants.

Economics

The initial investment is EUR 0.015 to 0.8/t installed, along with operating costs of EUR 0.015 to 0.8/t.

Driving force for implementation

Process quality and customer requirements

Example plants

Many continuous electroplating lines in EU-15.

Reference literature

[19, Eurofer, 2003]

4.14.4.2 Use of cascade rinse systems

See Sections 2.9.10.4 and 4.7.10. The first spray water is recycled back to the initial stages.

Achieved environmental benefits

Significant reduction in water consumption within the process, with a commensurate reduction in waste water volumes and treatment

Applicability

To new and existing plants for rinsing.

Economics

The initial investment is EUR 0.015 to 0.8/t installed with an operating and maintenance cost of EUR >0.8/t.

Driving force for implementation

Process efficiency.

Reference literature

[19, Eurofer, 2003]

4.14.5 Squeeze rolls

Description

See drag-out reduction, Section 4.6. The remaining solutions or rinse-waters on the steel strip are removed from the strip by squeeze rolls before leaving each section. This ensures that the drag out of solution into the next section is minimised as is the loss of chemicals and contamination of rinse-waters.

Achieved environmental benefits

There is significant reduction of raw material consumption. This then reduces the rinsing water needed and the waste water volumes. There is a consequent reduction in treatment chemicals and sludge produced at the waste water treatment plant.

Cross-media effects

No negative effects.

Operational data

See emissions from the process, waste sludge, water usage and raw material usage, in Section 3.4.1.

Applicability

To new and existing plants after the plating section and passivation sections

Economics

The initial investment is moderate at about EUR >0.015 - 0.8/t installed and the operating costs are low, at about EUR 0.001 - 0.15/t.

Driving force for implementation

Process efficiency including cost and quality.

Reference data

[19, Eurofer, 2003]

4.14.6 Electrolytic strip cleaning

See Section 4.9.14.8.

4.14.7 Use of ultrafiltration systems to regenerate degreasing solution

See Section 4.11.13.6

4.14.8 Cascade (multiple) use of degreasing solutions

See Section 4.11.13.1.

4.14.9 Control of the acid bath in the pickling section

See Sections 4.8.1 and 4.11.14.

4.14.10 Control and management of electrolyte consumption

Description

See Sections 4.7.2 and 4.7.5.

For tin plating: Following the plating section, the strip passes through a rinse section drag-out. To minimise the loss of electrolyte, the electrolyte is spray rinsed with a dilute solution of PSA and tin, it is then returned to an electrolyte recirculation tank. An evaporator system is then used to condense the dilute electrolyte solution through evaporation, and then returned to the process for re-use.

For acid zinc plating: An evaporator in a closed loop with a scrubber (for the plating cells) as with the zinc electrolyte tanks and the plating rinse cells, concentrates the ions (Zn^{++} , SO_4^{-}) in the residue and produces distilled water from the steam. The concentrated ions are re-used and injected into the electrolyte while the distilled water is re-used and injected into the different processes.

Achieved environmental benefits

Reduction of raw material consumption as the electrolyte is re-used. Reduction of waste water volumes and sludge from the waste water treatment plant.

Cross-media effects

None.

Operational data

See emissions from the process, waste sludge, water usage and raw material usage, Sections 3.4.1 and 3.4.2

Applicability

To new and existing plants.

Economics

For tin: Initial investment is EUR 0.015 to 0.8/t installed with operating and maintenance costs of EUR 0.015 to 0.8/t.

For zinc: The initial investment is EUR >0.8/t installed, with EUR 0.015 to >0.8/t for operating and maintenance costs.

Driving force for implementation

Process efficiency and product quality.

Example plants

Many continuous electroplating plants in the EU-15.

Reference literature

[19, Eurofer, 2003]

4.14.11 Switching the polarisation of the electrodes in the electrolytic processes

See Section 4.8.3.

4.14.12 Optimisation of the anode-cathode gap

Description

A mechanism of adjusting the gap as a function of the processed strip to be processed (width-thickness-flatness).

Achieved environmental benefits

Optimisation of the energy consumption, reduction of the contacts between anode and strip surface, increasing quality and cutting strip rejections.

Cross-media effects

None

Applicability

To new lines.

Economics

The initial investment is EUR 0.001 to 0.15/t installed with operating and maintenance costs of EUR 0.001 to 0.15/t.

Driving force for implementation

Process efficiency, reduced energy consumption.

Example plants

Many continuous electroplating plants in the EU-15.

Reference literature

[19, Eurofer, 2003]

4.14.13 Polishing the conductor roll

Description

Oscillating abrasive blades continuously polish the conductor rolls surface avoiding zinc and or nickel build-up.

Achieved environmental benefits

Longer conductor roll lifetime, longer processing time, minimisation of strip surface defects.

Cross-media effects

None.

Operational data**Applicability**

To new and existing lines.

Economics

The initial investment is EUR 0.015 to 0.8/t installed, with operating and maintenance costs of EUR 0.001 to 0.15/t.

Driving force for implementation

Productivity, conductor rolls lifetime, plated strip yield and quality.

Example plants

Many continuous electroplating plants in the EU-15

Reference literature

[19, Eurofer, 2003]

4.14.14 Using edge polishers

Description

Removal of zinc dendrites formed at the strip edges in zinc electroplating cells equipped with low anode-cathode gaps.

Achieved environmental benefits

Minimisation of strip surface defects (dents).

Cross-media effects

Material losses.

Operational data**Applicability**

To new and existing lines in the EU-15.

Economics

The initial investment is EUR 0.001 to 0.15/t installed, with operating and maintenance costs of EUR 0.001 to 0.15/t.

Driving force for implementation

Plated strip yield and quality to customer's requirements.

Example plants

Many continuous electroplating plants

Reference literature

[19, Eurofer, 2003]

4.14.15 Using edge masks

Description

Edge masks move between the anode and the strip to avoid zinc dendrites and zinc overthrow (when plating one side only) at the strip edges.

Achieved environmental benefits

Environmental benefit low.
Avoids side trimming (material loss), minimisation of strip surface defects.

Cross-media effects

None.

Applicability

To new lines and existing lines if the anode-cathode gap is wide enough.

Economics

The initial investment is medium, with medium operating and maintenance costs.

Driving force for implementation

Plated strip yield and quality.

Example plants

Many continuous electroplating plants use this technique in the EU-15.

Reference literature

[19, Eurofer, 2003]

4.14.16 Minimise use of oil by covered electrostatic oilers

Description

A light oil (anticorrosion or deep drawing oil) is heated and electrostatically deposited on the surface. The oil layer weight lies within a narrow range. The machine is covered and the splashed oil is collected and re-used. Electrostatic application is a more efficient and effective method of coating to minimise the amount of oil used within the system.

Achieved environmental benefits

Reduction of raw material consumption, minimises waste and oil fume emissions.

Applicability

To new plants and existing plants if space is available.

Economics

The initial investment is EUR >0.8/t installed with EUR 0.015 to 0.8/t operating costs.

Driving force for implementation

Primarily customer requirements, then process efficiency.

Example plants

Many continuous electroplating plants

Reference literature

[19, Eurofer, 2003]

4.14.17 Maintenance of process solutions

See Section 4.11. where specific examples of applications for coil coating are described.

4.14.17.1 Cleaning and recirculation of degreasing baths

Description

See Section 4.11.13.

Spent degreasing solution is cleaned; the oil residues out of the regeneration devices are recovered for heat recovery; the treated degreasing bath is recycled within the degreasing section.

Achieved environmental benefits

Significant reduction of alkaline chemical consumption, reduction of water and sludge volumes in the waste water treatment plant.

Cross-media effects

Increases section energy consumption.

Applicability

To new and existing plant, if space is available.

Economics

The investment costs are EUR 0.015 to 0.8/t installed and operating costs are EUR 0.001 to 0.15/t.

Driving force for implementation

Process efficiency primarily.

Example plants

In several continuous electroplating lines in the EU-15.

Reference literature

[19, Eurofer, 2003]

4.14.17.2 Continuous filtering and re-use of the zinc bath

Description

By-pass mechanical filtering for bath regeneration and internal recycling is used for cleaning zinc baths.

Achieved environmental benefits

Environmental benefit are medium.

Reduces materials input (Zn, H₂SO₄), water consumption, waste water and sludge releases.

Cross-media effects

Low amount of energy used for pumping through filters.

Applicability

To new and existing lines if space is available

Economics

The initial investment is medium, with medium operating and maintenance costs.

Driving force for implementation

Process efficiency, primarily customer requirements.

Example plants

Many continuous electroplating plants in the EU-15.

Reference literature

[19, Eurofer, 2003]

4.14.17.3 Continuous removal of iron and re-use of the zinc bath

Description

The electrolyte is circulated through an off-line tank and treated with H₂O₂ to oxidise Fe(II) into Fe(III). The Fe(OH)₃ is collected either by precipitation or by an ion exchanger.

Achieved environmental benefits

Reduces materials input (Zn, H₂SO₄), water consumptions, waste water and sludge releases, reduces strip defects.

Cross-media effects

None.

Applicability

To new and existing lines, if space is available.

Economics

The initial investment is EUR 0.015 to 0.8/t installed, with EUR 0.015 to for 0.8/t operating and maintenance costs.

Driving force for implementation

Process efficiency, primarily customer requirements.

Example plants

Many continuous electroplating plants in the EU-15.

Reference literature

[19, Eurofer, 2003]

4.14.17.4 Cleaning and regeneration of the phosphate bath

See Section 4.11.12

4.14.17.5 Cleaning and regeneration of the chromate bath**Description**

See techniques given in Section 4.11. Spent chromate bath is filtered; the concentrations in metallic ions and the pH are adjusted. The regenerated chromate solution is re-used.

Achieved environmental benefits

Environmental benefit is high: reduces chemicals consumption, reduces water and sludge releases

Cross-media effects

Depends on regeneration techniques used.

Operational data**Applicability**

To new and existing plants, if space is available

Economics

The investment costs are EUR 0.015 to 0.8/t installed and operating costs are EUR 0.001 to 0.15/t.

Driving force for implementation

Process efficiency primarily.

Example plants

Several continuous electroplating lines

Reference literature

[19, Eurofer, 2003]

4.14.18 Control of emissions to air

4.14.18.1 Collection and scrubbing

Description

See Section 2.13.3. For coil processing, to maintain occupational health standards within the workplace, air can be extracted from cleaning, pickling, plating and chemical treatment sections. A scrubber system using wet scrubbers and demisters is used to remove contaminants.

Achieved environmental benefits

Reduction in emissions to air.

Cross-media effects

Increase in energy consumption. Increase in the amount of waste water s requiring treatment.

Operational data available/if applicable

See emissions from the process, waste sludge, and water usage, in Section 3.4.1.

Applicability

To new and existing plants.

Economics

The initial investment is EUR >0.8/t installed, with operating and maintenance costs of EUR >0.8/t.

Driving force for implementation

Workplace environmental and health and safety legislation.

Avoids deterioration of installations and buildings through corrosion.

Example plants

Many continuous electroplating plants in EU-15.

Reference literature

[19, Eurofer, 2003]

4.14.18.2 Covered treatment baths

Description

See Section 4.18.2. It is good practice to cover all tanks excluding those with fume exhausts. All chemical treatment and rinse baths (degreasing, pickling, plating, chromating) are covered and are at negative pressure to avoid emissions of fumes and aggressive waste air.

Achieved environmental benefits

Environmental benefit high. Reduction of fugitive emissions to air.

Cross-media effects

None.

Applicability

To new and existing plants.

Operational data

There are practical difficulties in some applications, such as space, access for maintenance, etc.

Economics

The initial investment is EUR 0.015 to 0.8/t installed with maintenance requirements at EUR 0.001 to 0.15/t.

Driving force for implementation

Workplace environmental conditions, health and safety legislation.

Example plants

Many continuous electroplating lines in the EU-15.

Reference literature

[19, Eurofer, 2003]

4.14.19 Waste water treatment processes

See Section 4.16 for a description and discussion of techniques. For coil coating, investment costs are EUR >0.8/t installed, with operating costs of EUR >0.8/t.

4.14.20 Recovery of residual metals from tanks**Description**

The tin from the recirculation tanks can be recovered through treatment of the waste waters by precipitation using lime and then reprocessing by a metal reprocessor.

Achieved environmental benefits

Reduction in waste to landfill and recovery of the raw material.

Cross-media effects

Lime used in the process.

Applicability

To new and existing plants.

Economics

The initial investment is EUR 0.015 to 0.8/t installed along with maintenance costs of EUR 0.015 to 0.8/t.

Driving force for implementation

Process efficiency and reduction in waste disposal costs

Reference literature

[19, Eurofer, 2003]

4.15 Printed circuit board processing

Many of the techniques used in PCB manufacture are described elsewhere in this document and are cross-referenced. Information can be also be found in the reference literature quoted.

4.15.1 Manufacture of inner layers

Description

Section 2.11.2.6 describes the black and brown oxide processes, and refers to newer processes. The black oxide is produced using chemicals such as sodium hypochlorite at high temperatures (approximately 80 °C). This is increasingly being replaced by the brown oxide process, which uses less hazardous chemicals such as sulphuric acid, hydrogen peroxide and organic additives which are biodegradable at temperatures of approximately 30 °C. The elementary copper is oxidised to copper (I) and preserved by additives.

However, other processes are now emerging (sometimes referred to as oxide alternative treatments). Developments of these processes are rapid and driven by ever-increasing higher technical requirements

Achieved environmental benefits

Use of less hazardous chemicals.

Lower temperatures.

Less waste water is produced (see Operational data, below).

Cross-media effects

When a new solution is made (which becomes necessary every 24 months), the used solution is treated in a batch process by alkaline precipitation.

The acidic exhaust air is neutralised by an air scrubber.

Operational data

The concentration of the individual components is kept at a constant level by replenishing chemicals depending on the production volume. This replenishment equalises the loss of liquid which occurs by evaporation. Thus, hardly any effluents are generated.

Driving force for implementation

Product quality.

Workplace health and safety.

Example plants

Major PCB producers in Germany use the brown oxide technique.

Alternative techniques are used in Finland.

Reference literature

[122, UBA, 2003], [159, TWG, 2004]

4.15.2 Rinsing between steps

See Sections 4.6 and 4.7. PCBs are usually operated in horizontal in-line modules, but the same techniques are applicable as for the other processes. In addition, squeeze rollers are used for PCBs which greatly assist with the prevention of drag-in and drag-out.

4.15.3 Electroless (autocatalytic) plating

See other solution maintenance techniques in Sections 4.7, 4.9.1, 4.11. For EDTA treatment see Section 4.16.8.

4.15.4 Electroplating PCBs

Description

See the general issues applicable to electroplating in the Sections 4.5 to 4.11. In order to obtain a metal deposition as even as possible for PCBs it is state of the art in vertical installations to use direct air injection, combined with oscillation- and vibration of the boards.. In addition, the panel is fixed in the lower part of the bath so that an optimum exchange of electrolytes inside the holes is possible across the whole panel (usually 600 x 600 mm). The individual baths (micro etching, acid dipping, electroplating and rinsing) are served by automatic carriers.

Achieved environmental benefits

Minimisation of rejects.

Cross-media effects

See agitation, Section 4.3.4

Driving force for implementation

Production quality.

Reference literature

[122, UBA, 2003]

4.15.5 Development of dry resist by sodium carbonate

Description

The equipment for the development of dry resist consists of the development unit and a smaller downstream chamber which contains a fresh solution of sodium carbonate (see Section 2.11.2.8)

In order to reduce the drag-out of contaminated developer solution into the following fresh water rinsing zones, the panel surface is rinsed with clean developer solution.

The manifolds are equipped with an oscillation to bridge the mechanical effect of the spray nozzles and a better exchange of solution. The fan jet nozzles are to be installed at an angle of approximately 30 - 40° transverse to the direction of process. In the case of multiple nozzle bars these may be installed against each other. This step uses water and chemicals economically

It is good practice to control the concentration of the developer solution (0.8 – 1.0 % Na₂CO₃) by conductivity, to check by laboratory analysis and to replenish it when necessary by adding fresh solution. Used solution is collected as effluent in a buffer vat; fresh solution is added from a sodium carbonate mixer (containing 10 % soda) and the following rinsing cascade as per requirement.

It is good practice to separately treat the effluents that are loaded with resist. There are various treatments are available for this, such as ultrafiltration.

Achieved environmental benefits

Minimises chemical and water usage.

Minimises the effect of batch discharging to the waste water treatment plant

Applicability

All dry resist developers.

Economics

The use of ultrafiltration for the effluent may depend on the amount of water discharged. Ultrafiltration is reported to be cheaper than precipitation.

Example plants

Schweizer Electronic AG, Ruwel AG, Germany.

Reference literature

[122, UBA, 2003]

4.15.6 Etching

Description

See Section 2.11.2.9. It is good practice to monitor acidic etchant ($\text{HCl} + \text{H}_2\text{O}_2$) online. The concentration of hydrochloric acid is determined via a titrator and replenished if necessary. The redox potential can also be monitored via a redox electrode and the hydrogen peroxide replenished.

Alkaline etching is conducted in a horizontal production line equipped with oscillation and special nozzles for an effective removal of copper. The solution is initiated by incorporating some etched copper. This solution is replenished continuously. The replenisher solution contains, among other substances, ammonium salts (chloride, sulphate, carbonates). By using ammonia the solution is adjusted to a pH level of 8 – 9.5.

After the etching process it is good practice to recirculate the rinsing water of the first cascade into the etching solution. The etching parameters are kept at a constant level as far as possible by continuously controlling and replenishing the solution with regeneration chemicals. Part of the solution is continuously discharged from the etching equipment. The copper (II) chloride waste solution resulting from the etching process is collected in a storage tank and is reconditioned externally by specialised companies into copper salts and hydrochloric acid. These basic materials can be fed into industrial processes again.

Acidic exhaust fumes may be removed via an air scrubber filled with an alkaline solution (NaOH) for neutralisation.

Achieved environmental benefits

Optimisation of chemicals usage and minimisation of water usage.

Recovery of copper and etchants from the used solutions.

Cross-media effects

Transport, storage and handling of waste solutions.

Alkali air scrubber solutions can be treated in a typical waste water treatment plant

Applicability

To all etching systems.

Driving force for implementation

Product quality.

Workplace air quality standards.

Example plants

All major PCB manufacturers.

Reference literature

[122, UBA, 2003]

4.15.7 Recycling of alkali etchants online with copper recovery (liquid-liquid ion-exchange)

Description

The alkaline ammonia etching solution can be regenerated and the dissolved copper can be recovered on-site by a commercially available process. The patented unit is installed in a closed loop within an alkaline etching system shown in Figure 4.31 and achieves the following functions:

- continual regeneration of the alkaline etchant bath
- uninterrupted recovery of the etchant copper in high purity form.
- purification of the rinsing water for re-use after etching.

Used etchant with 150 g/l of copper is passed through the first immiscible organic liquid extraction solution (in the Recycling equipment, see Figure 4.31) and is returned as regenerated etchant with 110 g/l of copper. The solvent is now loaded with 50 g/l of copper.

Spent rinse-water with 5 g/l (5000 mg/l) of copper goes through a second immiscible organic liquid extraction solution (in the Recycling equipment, see Figure 4.31) and comes out as regenerated rinse-water with 5–6 mg/l of copper. The immiscible organic liquid from this second extraction is loaded with an additional 5 g/l of copper.

The immiscible organic liquid is passed through a third extractor containing water-based electrolyte, has its copper load removed, and is returned to the first extractor. After the third extractor, the electrolyte is loaded with approximately 55 g/l of copper.

The copper is plated from the electrolyte onto the cathode in the electrowinning (electrolytic) cell.

Description of chemistry

For etching metallic copper from printed circuit boards:

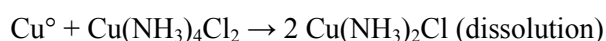

In summary:

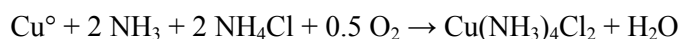

For extracting copper from spent etchant and used rinse-water (where R represents the molecule in the immiscible organic liquid extraction solution):

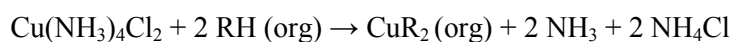

For extracting copper from the organic liquid to the electrolyte:

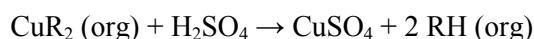

For electrowinning copper metal from the electrolyte:

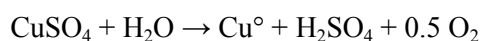

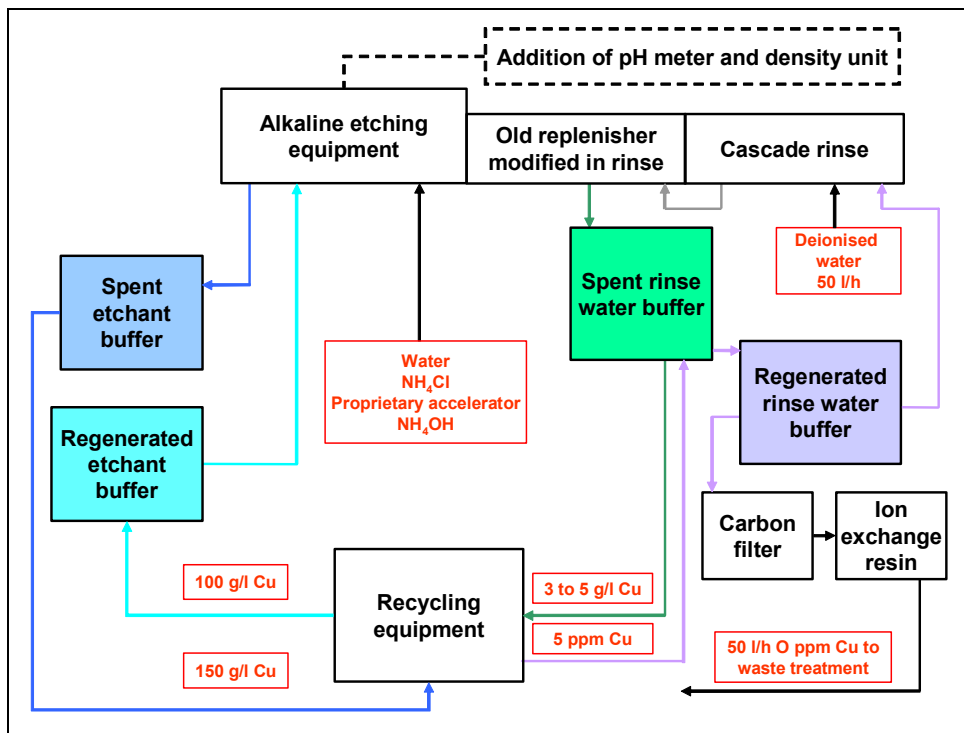

Figure 4.31: Recycling of alkali etchant in printed circuit board manufacture [49, France, 2003]

Achieved environmental benefits

Reduction of ammonia and copper in the effluent.

Recovery of about 600 kg high quality copper per month (in example plant).

Decreased noise to local residential property from delivery and disposal vehicles.

Cross-media effects

Some additional power consumption for the unit.

The copper recovered is too high purity to re-use in-plant and is sold to a supplier.

Operational data

The equipment must be maintained by a skilled operator

Applicability

Alkali copper etchants.

Patented process.

Economics

Investment of EUR 100000 to 150000 (year 2003).

Payback: more than three years cost recovery from the resale of high quality copper, reduced effluent treatment and cost of replenishing etchant solution.

Driving force for implementation

Improved production quality of the printed circuit boards due to:

- constant etchant strength which allows constant speed through the etching process
- less handling problems of hazardous chemicals in delivery and disposal
- reduction of replenisher addition
- less tanker deliveries, with decreased noise.

Other advantages:

- no storage of spent etchant
- no transport and delivery of etchant solutions, reducing handling risks, etc.
- reduced noise and improved public perception of operation in neighbouring residential area.

Example plants

SOFRA-PCB, Mennecy, France.

Reference literature

[49, France, 2003]

4.15.8 Resist stripping

Description

The cured dry resist is removed by either a proprietary solution or sodium hydroxide solution (approximately 20 ml/l), see Section 2.11.2.8. When this solution is sprayed onto the resist it swells and comes off as flakes. The coarse particles may be separated by a centrifuge and disposed of as waste. The effluent, which is loaded with resist, may be discharged either directly or via a buffer vat into ultrafiltration equipment and cleaned with final pH adjustment.

Achieved environmental benefits

Removal of solids from waste water.

Cross-media effects

Resist waste generated.

Applicability

To all resist stripping in PCB installations, but see Economics, below.

Economics

Cost of centrifuging and ultrafiltration.

Driving force for implementation

Waste water policy and legislation.

Example plants

Many PCB plants in Germany.

Reference literature

[122, UBA, 2003], [12, PARCOM, 1992]

4.15.9 Stripping of etch (tin) resist

Description

In horizontal production lines, an acidic medium containing nitric acid is applied by spray for stripping the etch resist (see Section 2.11.2.10). Organic complexing agents are present which require additional steps for the disposal of effluents. The rinsing waters and the concentrate have to be collected separately and treated with an organosulphide compound. The precipitate can be sent for recycling as a tin-rich sludge. The used concentrates may be disposed of externally.

Achieved environmental benefits

Separate treatment enables waste water treatment prior to discharge.
The tin may be recovered from the sludge produced.

Cross-media effects

Use of additional treatment chemicals.

Applicability

To all etch resist processes.

Driving force for implementation

Waste water policy and legislation.

Example plants

Most PCB plants in Germany.

Reference literature

[12, PARCOM, 1992, 122, UBA, 2003]

4.15.10 Disposal of solutions

Description

Certain process baths usually contain strong complexing agents, for example:

- immersion or direct plating, see (e.g. copper, nickel, precious metals)
- black or brown oxide

They should be identified (see Section 4.16.1) and require either:

- destruction of the complexing agents (which may be on-site or off-site) prior to treatment of the metals (see Section 4.16.8)
- disposal off-site (with and without recovery, see Section 4.17).

Achieved environmental benefits

Avoids disruption of the waste water treatment system

Cross-media effects

Increased waste production.

Applicability

All direct plating solutions.

Example plants

Most major PCB producers in Germany and Finland.

Reference literature

[122, UBA, 2003] [159, TWG, 2004]

4.15.11 Solvent emissions from the application of solder mask

Description

The solder masks used consist of epoxy and acrylate resins. They contain photo-initiators and fillers. Increasingly, aqueous alkaline lacquer systems are used. Prior to exposure, they are soluble in aqueous alkaline solutions; and are developed in a 1 – 3 % solution of sodium carbonate. The effluent may be treated by ultrafiltration or by a precipitation method using an acidic medium and then disposed of.

However, even aqueous alkaline solder masks contain up to 50 % solvents (i.e. methoxypropyl acetate). Consequently, installations with an annual consumption of solvents of 5 – 15 t/yr. (threshold value) are subject to the Solvent Emissions Directive (SED) In order to stay below the emission limit values, the PCB manufacturer either has to persuade his supplier to increase the percentage of solid contents within the lacquer system or has to install suitable treatment systems to the air extraction systems (e.g. condensation, incineration, biological filters).

Achieved environmental benefits

The reduction of VOC emissions.

Cross-media effects

Increased power consumption for additional equipment.

Applicability

To all solder mask applications, especially those within the SED limits.

Economics

The cost of additional air treatment systems.

Driving force for implementation

Solvent Emissions Directive [97, EC, 1999].

Example plants

Reference literature

[122, UBA, 2003]

4.16 Waste water emission abatement techniques

The bulk of emissions to the environment from an installation for the surface treatment of metals and plastics occur to water, see Section 1.4.2. Minimisation (including minimisation spillages), recycling and re-use are important issues for the management of waste waters [13, UNEP, et al., 2002] and are dealt with in Sections 4.4.5, 4.6 and 4.7.

Waste water treatment is described extensively elsewhere, such as generally in the BREF on waste water/waste gas systems [87, EIPPCB,], and specifically for this sector [6, IHOBE, 1997, 21, Agences de l'Eau de France, et al., 2002]. The following sections are therefore a brief description of relevant techniques.

Process waters are usually treated in a waste water treatment plant with a sequence of process steps, see Section 2.13.1, which also illustrates a typical waste water treatment plant (Figure 2.42).

4.16.1 Identification of problem flows

Description

Changes in sources or types of process chemicals can create problems in waste water treatment, by unknowingly introducing chemicals that interfere with the process treatments. They are usually either surfactants that interfere with flocculation and/or settlement processes, or complexing agents that prevent metals precipitating. They can be tested prior to their introduction into production.

Achieved environmental benefits

Consistency of waste water treatment to required levels.

Cross-media effects

None.

Operational data

Changes in sources or types of process chemicals can be tested for simply, by mixing samples of the usual waste water (taken prior to settlement, but after pH adjustment and flocculation) with expected dilutions of the new chemicals and checking for any detrimental effects, such as poor settlement of solids, higher than usual metals levels in the supernatant liquid, etc. If any problems are identified, then either:

- the new solution is rejected
- the waste water treatment system is changed to compensate.

Applicability

All changes of source or type of process chemicals (usually mixtures and/or proprietary chemicals). Does not apply to single substances, such as acids, etc.

Economics

Low cost: only the cost of the relevant analysis.

Driving force for implementation

Cost savings in resolving waste water treatment problems and breaches of permit conditions.

Example plants

Collini GmbH, Austria

Reference literature

(Personal communication, Martin Peter, Collini GmbH) [159, TWG, 2004]

4.16.2 Elimination and/or separation of the individual pollutants at the point of generation

Description

Some chemicals are most effectively managed by treating them separately before mixing with other effluents.

Other chemicals such as pickling acids and chemical degreasers, are discharged irregularly and in large quantities that can exceed the capacity of a continuous-flow treatment plant, and can cause breaches of permit conditions. They can be managed by:

- avoiding bulk discharges (for example, see counterflow pickling, Section 4.11.14.1)
- containing in bulk and bleeding to the in-house waste water treatment plant over a period of time, to stay within the internal treatment plant's capacity (Note: it is not good practice to use this technique to discharge by dilution to the municipal waste water treatment plant)
- containing in bulk and using alkali solutions to neutralise acid solutions (such as alkali degreasers to neutralise acid pickling solutions)
- batch managing and discharging the effluent, see Section 4.16.13
- disposing of waste solutions that cannot be successfully treated in the waste water treatment plant for third party recovery or as wastes (see Section 4.17.3).

In some cases, chemicals may be kept separate to assist with third party recovery, as well as reducing waste water treatment requirements, such as pickling acids (see Section 4.17.3).

Achieved environmental benefits

For some substances, contaminant treatment and removal is only possible after separate treatment.

Avoidance of bulk discharges exceeding treatment plant capacity and breach of permit conditions.

Use of waste alkali solutions (such as degreasers) to neutralise waste acid solutions saving chemicals.

Cross-media effects

Will be case-dependent.

Operational data

Flows containing cyanide-, nitrite- and chromate must be pretreated separately before being mixed together or with other waste waters. For example:

- nitrites can be oxidised or reduced; both reaction types need a slightly acid solution (pH 3 – 4, see Section 4.16.5)
- cyanide oxidation must be accomplished in alkaline solution (pH >10, see Section 4.16.4)
- chromate reduction takes place at pH values <2.5 (see Section 4.16.6).

In order to limit the use of additional chemicals, acid waste water can be neutralised with alkaline waste water: they must, however, be free of complexing agents.

Other substances can be managed separately to reduce the amount of contaminant discharged, and reducing or eliminating the need for further treatment. Examples are the use of countercurrent rinsing and evaporation to close the materials loop from copper, nickel and chromium plating, and the use of electrolytic cells with chromium and nickel plating.

Cadmium (and mercury) processes (see Section 2.5.5) are subject to other legislation (see Annexes 8.1 and 8.3). In Germany, legislation requires that they are separated and treated according to BAT before mixing with other effluents. A similar approach is taken in the UK.

Applicability

It is good practice to consider every process discharge point whether treatment (or recycling or re-use) is better carried out on the separated stream, before mixing flows for subsequent treatment.

When using waste alkali flows to neutralise waste acids, additional chemicals may be required to achieve a suitable pH for discharge through a flocculation system.

Economics

In some specific cases, capital and treatment costs may be significantly reduced by treating individual waste water streams separately. However, usually the cost for treating separated streams is higher.

Driving force for implementation

The specific process chemistry will dictate which chemicals may require separation. Separate treatment streams may be more efficient and cost-effective.

Example plants

Townrow (Hi-Tech) Plating Ltd, Sheffield, UK for countercurrent rinsing and electrolytic treatment of chromium and nickel drag-out streams.

Merrydale Industries Ltd, Wednesbury, UK for countercurrent rinsing and evaporation closing the loop for copper, nickel and chromium plating.

Frost Electroplating Co. Ltd, Birmingham, UK, for closing the loop on nickel plating by four-stage countercurrent rinsing with evaporation.

Metal Colours Ltd, Slough, UK, for countercurrent pickling.

SGI, Plaisir, CIRE Bellegarde, and SOFRA-PCB, Champoreaux, France for the treatment of separate streams, then bulking for final treatments and settlement.

Reference literature

[18, Tempany, 2002, 156, France, 2003] [12, PARCOM, 1992, 13, UNEP, et al., 2002] [124, Germany, 2003].

4.16.3 Separation of oils and greases (hydrocarbons) from waste water

Generally the separation of oils and greases is undertaken while managing the degreasing solutions. In special cases, a de-oiling of raw waste water before the inorganic treatment is necessary, and the procedures for this application are described in Section 4.11.13.

4.16.4 Cyanide oxidation

Description

Cyanides can be removed from waste water using different procedures:

- oxidation with different oxidising agents:
 - sodium hypochlorite
 - hydrogen peroxide
 - oxygen (O₂)
 - ozone (O₃)
 - anodic oxidation (electrolysis), see Section 4.12.1
 - potassium monopersulphate.
- transfer into insoluble metal complexes (e.g. iron cyanide connections)
- removal by ion exchangers
- destruction of the cyanide by thermal procedures
- radiation-assisted oxidation (oxidising agents and UV radiation)
- anodic oxidation.

In practice, the chemical oxidation of cyanide is the most commonly used technique.

Achieved environmental benefits

Destruction of cyanide.

Cross-media effects

Use of chemicals and energy (for thermal, radiation and anodic techniques) and the possible production of AOX if using hypochlorite.

Operational data

The use of sodium hypochlorite is associated with the formation of organic chlorine compounds, measured as AOX. For this reason, the replacement of sodium hypochlorite as an oxidising agent in the cyanide oxidation has been much discussed. However, since none of the alternatives mentioned show a universal solution for efficient cyanide destruction, the employment of sodium hypochlorite is still the most used procedure.

Anodic oxidation is a suitable technology for the destruction of cyanide complexes in process solutions containing cyanide and rinsing waters from zinc and copper plating. The residual cyanide content attainable with the anodic oxidation is below 0.1 g/l. A limit value of <0.2 mg/l is achieved by an additional chemical treatment with sodium hypochlorite. Additionally to the cyanide destruction, the dissolved metals are recovered and can be re-used.

Applicability

Chemical oxidation is widely used. Hydrogen peroxide can readily replace hypochlorite, but the cost is higher.

Driving force for implementation

Water protection policies and legislation.

Example plants**Reference literature**

[21, Agences de l'Eau de France, et al., 2002] [12, PARCOM, 1992] [126, Netherlands, 2003] [113, Austria, 2003] [124, Germany, 2003] [104, UBA, 2003]

4.16.5 Nitrite treatment**Description**

Nitrite can be oxidised either to nitrate or reduced to nitrogen. Both reactions take place in weak acid conditions around pH 4.

Achieved environmental benefits

Destruction of nitrite.

Cross-media effects

Possible AOX formation if hypochlorite is used.

Low pH with high nitrite concentrations can lead to NO_x formation.

Any excess sodium dithionite can complex with metals ions.

Operational data

For oxidation, H₂O₂ is normally used. Sodium hypochlorite was used most frequently as a nitrite oxidising agent, but use is decreasing because of the possibility of associated AOX formation.

The reducing agent is normally amidosulphuric acid. The disadvantage of this reaction relates to a high sulphate concentration in the waste water. It is also possible to use urea; however, this has the disadvantage that the reaction needs a temperature of 60 °C. It is possible to reduce this with hydrogen sulphite, but it is not often used as it causes a high concentration of sulphate into the waste water.

In an acid solution, nitrite can easily be reduced using sulphamic acid.

The use of sodium dithionite and Fe (II) would eliminate some cross-media effects.

Air extraction may be necessary as pH lowering with high nitrite concentrations leads to the formation of nitrous gases. Since nitrous gases by themselves dissolve badly in water, an exhaust air scrubber with alkali solution may be necessary, although this may not remove all nitrous gases produced from high concentration solutions. In batch treatment, it may be necessary to add a small amount of oxidising agent before reducing pH.

Applicability

Widely used.

Driving force for implementation

Water pollution protection legislation.

Reference literature

[21, Agences de l'Eau de France, et al., 2002], [104, UBA, 2003], [124, Germany, 2003, Austria, 2003 #113]

4.16.6 Chromate treatment

Description

Hexavalent chromium compounds (chromates or dichromate) are difficult to precipitate and are normally reduced to trivalent (chromium (III) ions), which are subsequently precipitated as chromium (III) hydroxide on neutralisation. The reduction is made at pH values under 2.5. The most common reducing agent is sodium hydrogen sulphite (bisulphite).

If only a small amount of chromium (VI) is present at high pH values, the reaction can also be carried out in the alkaline region with sodium dithionite or iron II. No addition of acid is needed.

Achieved environmental benefits

Reduction and removal of chromium (VI).

Cross-media effects

Care should be taken with sodium hydrogen sulphite (bisulphite), as SO_x fumes are formed. Workplace ventilation may be required.

When using iron (II), more sludge and therefore waste will be generated in the waste water treatment (as iron (III) hydroxide).

Applicability

Widely used.

Driving force for implementation

Water pollution protection legislation.

Reference literature

[21, Agences de l'Eau de France, et al., 2002] [124, Germany, 2003]

4.16.7 Flocculation and precipitation of metals

The ultimate process control is by precipitating metals separately (adjusting the pH to its optimum value for the metal) but this is not possible and economically feasible in many cases. If there are many processes and process baths, and separation of different waste water streams is difficult, metals can be precipitated simultaneously (co-precipitation) [120, Finland, 2003]. A mixture of discharges from processes makes it more difficult to maintain the optimum pH balance for precipitation for all the dissolved metals.

It is important to note that the total dissolved ion content may also affect the solubility of metals, and this can be increased by water-saving measures and the discharge of ion-exchange regeneration solutions. (Personal communication, Ministry of Environment, Slovenia).

The final cleaning of effluent by using chelating cation exchange resin can then be more efficient. The efficiency of chelating cation exchange resin also depends on the effluent pH. The optimum pH is different for each metal.

4.16.7.1 Hydroxide precipitation

Description

This is described in Section 2.13.1.7. The removal of the transition metals is made via neutralisation and then precipitation at pH values of 9 - 11. A water-solid mixture results from the precipitation, usually referred to as electroplating sludge (dependent on source activities).

Achieved environmental benefits

Removal of transition metals from the effluent.

Operational data

Combining the different waste water streams for precipitation together has the effect that metals with poor precipitation characteristics are precipitated by those metal hydroxides with good precipitation characteristic, so it is possible to reach a better result with common precipitation. For example, nickel co-precipitation with other metal ions, and the co-precipitation of cadmium and FeII at pH 9. The emission value of cadmium in this case can be lower than 0.1mg/l. If precipitated separately, it is not possible to achieve such low cadmium levels.

On the other hand, some heavy metals, e.g. cadmium, lead and nickel need a high pH value for precipitation. Under these conditions, it is possible that other metal hydroxides, e.g. zinc, chromium, tin and aluminium, will be redissolved, so it may become necessary to have a separate precipitation at lower pH values with other precipitation agents, such as calcium or sodium hydroxides

The solubility of the metals increases with increased neutral salt concentrations. The metals partly precipitate in very fine particles (especially lead and tin), therefore the addition of flocculating agents (iron (III) chloride, lime) and/or flocculants (polyelectrolyte) are necessary for better separation and filtration. However, this leads to an increase in the quantity of sludge (waste) produced as iron compounds and lime need to be added in significant quantities. Polyelectrolytes have a much higher charge density and need a far lower dose rate.

To meet stringent emission limit values, fine filtration may also be necessary. Sometimes a post-treatment is also necessary, for example with sulphide and/or selective ion exchangers.

Cadmium may be treated separately (see Section 2.5.5).

Applicability

Widely used. Settlement tanks need space and may be costly to install.

In all cases, the choice between precipitating separately or co-precipitating metal ions must be made after tests of treatment have been carried out.

Driving force for implementation

Water protection policy and legislation

Reference literature

[21, Agences de l'Eau de France, et al., 2002] [12, PARCOM, 1992] [126, Netherlands, 2003] [121, France, 2003, 124, Germany, 2003].

4.16.7.2 Sulphide precipitation**Description**

If the hydroxide precipitation followed by a post-cleaning stage with selective ion exchangers is not sufficient to meet limit values for discharge, a precipitation with sodium sulphide or organosulphide can achieve lower levels, see Table 4.18. Since the solubility of the metal sulphides is generally substantially lower than that of the metal hydroxides, smaller residual concentrations can be achieved with sulphide precipitation.

Metal	Solubility product (g/l)	
	Hydroxide	Sulphide
Aluminium	2×10^{-32}	--
Lead	1×10^{-7} to 10^{-13}	3×10^{-28}
Cadmium	1.3×10^{-14}	5.1×10^{-29}
Chromium (III)	3×10^{-28}	--
Iron (II)	2×10^{-15}	3.7×10^{-19}
Iron (III)	8.7×10^{-38}	--
Copper	2×10^{-19}	8×10^{-45}
Nickel	5.8×10^{-15}	1×10^{-26}
Silver	1.24×10^{-8}	1.6×10^{-49}
Zinc	4×10^{-17}	6.9×10^{-26}
Zinc(II)	6×10^{-25}	1×10^{-20}

Table 4.18: Solubility products of metal hydroxides and sulphides
UBA

Achieved environmental benefits

Low emission values for transition metals.

Cross-media effects

Avoid acid conditions to prevent emission of hydrogen sulphide. Excess sulphide must be eliminated by using iron salts

Handling of sulphide sludges can be difficult, with finer precipitates giving poor settlement and filtration properties.

Operational data

The addition of a flocculant is necessary with metal sulphides precipitation as the precipitates formed, as well as colloidal sulphur, are very fine and neither settle nor are filtered easily.

Economics

[21, Agences de l'Eau de France, et al., 2002]

Driving force for implementation

Water protection policy and legislation; low emission values where environmental quality standards require.

Reference literature

[82, Agences de l'Eau, 1996, 104, UBA, 2003], [113, Austria, 2003], [12, PARCOM, 1992, Netherlands, 2003 #126].

4.16.7.3 Other flocculating agents**Description**

Other flocculation agents are used:

- inorganic salts, such as of Fe(III) and aluminium
- organic polymers with a high molecular mass (10^6 to 10^7), an ionic structure (either anionic or cationic) and a high charge density. For surface treatment industries, anionic polymers are most often used.

Achieved environmental benefits

Increased flocculation and improved precipitation.

Cross-media effects

Inorganic salts can increase the bulk of material to be disposed of or managed subsequently. The addition of flocculating agents may assist with subsequent dewatering processes, with no further additions necessary.

Operational data

Generally mixed in a separate tank and dosed into the flocculating system prior to precipitation.

Applicability

Applicability is readily determined by on-site tests.

Economics

Can increase the efficiency of an existing waste water treatment plant. Low capital and operational costs.

Driving force for implementation

Water protection policy and legislation; low emission values where environmental quality standards require.

Reference literature

[21, Agences de l'Eau de France, et al., 2002] [12, PARCOM, 1992, Netherlands, 2003 #126]

4.16.8 Complexing agents**Description**

Complexing agents used in certain processes make the precipitation of transition metals more difficult, if they are mixed before treatment with other waste waters.

Copper can be precipitated from complexes by reduction with sodium dithionite, but excess dithionite mobilises copper from the hydroxide, preventing precipitation and copper is discharged in the effluent. By using stronger reducing agents, like sodium hypophosphite, other metals such as nickel and tin can be reduced. The metals are frequently precipitated as sulphides from hard complexes. Cationic metal complexes with ammonia or amines such as triethanolamine and Quadrol can be removed with weakly acid cation exchangers (for example, selective ion exchange resins with iminodiacetate groups). However, treatment with ion exchangers is not possible in solutions with citrate, EDTA and NTA.

The most common complexing agents are cyanides, polyphosphates, amines, citric acid, tartaric acid, gluconic acid, ammonia, NTA, EDTA, and Quadrol.

Using another procedure, all EDTA is destroyed in the presence of UV radiation and hydrogen peroxide. The copper largely has to be eliminated from the solution by electrolytic separation prior to using this technique. After the destruction of the Cu/EDTA complex, free copper is precipitated.

Achieved environmental benefits

This technique ensures that metals are not solubilised and carried into municipal waste water treatment or re-solubilised in the wider aquatic environment.

Cross-media effects

Additional chemicals and energy consumption, depending on the technique used.

Operational data

Where using complexing agents, particularly strong ones, separation of metals and complexing agents as far as possible prior to other treatments (such as flocculation and precipitation of the metal) is advisable.

Driving force for implementation

Water protection policy and legislation; low emission values where local environmental quality standards requires.

Reference literature

[12, PARCOM, 1992, Netherlands, 2003 #126, 104, UBA, 2003, 113, Austria, 2003]

4.16.9 Precipitation of anions

4.16.9.1 Fluoride precipitation

Description

Free fluoride ions can be precipitated with calcium, for example when neutralising with lime.

Achieved environmental benefits

Meeting fluoride emission standards.

Operational data

Fluoride precipitation can only be carried out quantitatively if least one calcium equivalent is present for every fluoride equivalent. Otherwise, additional calcium ions must be added, for example as calcium chloride.

Applicability

Complex fluorides, such as BF_4 , AlF_6 or SiF_6 , cannot be precipitated perfectly with calcium compounds.

Driving force for implementation

Water pollution protection legislation.

Reference literature

[3, CETS, 2002] [113, Austria, 2003]

4.16.9.2 Phosphate precipitation

Description

It may be necessary to reduce phosphate levels when the effluent is discharged to surface water or to municipal waste water treatment which does not treat phosphates. A release of 4 kg/day of phosphorus corresponds to the release from 1000 inhabitants (in the EU-15).

However, when it is required, it is rarely a problem, since sufficient metal ions are nearly always present in surface treatment waste waters to form insoluble phosphate compounds. If this is not the case, iron or aluminium compounds can be added. Precipitation can also be achieved with lime at pH values over 10.

Achieved environmental benefits

Meeting phosphate emission limit values where applicable. Phosphate is a major contributing factor to eutrophication. The discharge of a few kilos of phosphorus can have a strong impact on a river according to the size of the receiving flow.

Cross-media effects

Additional chemicals may be required.

Operational data

The precipitation of polyphosphates and phosphonates is difficult. In many cases, it is difficult to meet the environmental quality standards for total phosphorous (especially when directly discharging to surface water).

Driving force for implementation

Where water legislation and local environmental quality standards require.

Reference literature

[121, France, 2003] [3, CETS, 2002, 159, TWG, 2004]

4.16.9.3 Sulphate precipitation

Description

Treatment for sulphate is rarely required, although sulphate control may be locally important for the protection of receiving sewerage systems. Where applicable, discharge limit values are normally high, about 1000 mg/l, and sulphate is readily precipitated as calcium sulphate.

Achieved environmental benefits

Meeting sulphate emission limit values where applicable, usually for discharge to a foul sewer.

Cross-media effects

The use of additional chemicals

Sulphate precipitation creates more sludge for disposal

Precipitation of sulphate may also cause problems with recycling of sludges, such as the use of aluminium hydroxide sludge

Operational data

According to its solubility product, calcium sulphate has a solubility of 1404 mg/l as sulphate. This rises strongly with increasing neutral salt concentration, so that in the presence of 1 val/l neutral salt (this corresponds to a concentration of approximately 58.5 g/l common salt) the sulphate only precipitates at concentrations of 5000 mg/l, which corresponds to the solubility of the calcium sulphate. Different neutral salts have thereby a different influence on the attainable precipitation.

Applicability

It is usually not necessary to eliminate sulphate. Corrosion in sewers is caused in anaerobic conditions by certain bacteria utilising the oxygen in the sulphate and forming sulphuric acid. In some cases with effluents over 1000 mg/l, it may be better to protect or change the materials used in the sewerage system to those with more acid resistance, or treat the sewage to maintain aerobic conditions (such as by dosing with hydrogen peroxide). This will depend on the materials used in the construction of the sewerage system and the dilution with other waste water in the municipal sewage plant.

Driving force for implementation

Where water legislation and local environmental quality standards require.

Reference literature

[3, CETS, 2002] [113, Austria, 2003] [118, ESTAL, 2003] [18, Tempany, 2002, Germany, 2003 #124, ESTAL, 2003 #118]

4.16.10 Final treatment prior to discharge

General description

After precipitating the unwanted dissolved materials (principally the metal hydroxides), these and other materials in suspension are separated from the liquid by one of the following techniques:

- sedimentation (static)
- flotation
- filtration.

Traditionally, sedimentation has been used, followed by flotation. However, when considering revamping or updating waste water treatment plants to meet lower emission levels, and especially in conjunction with other objectives for recycling water and sludges, filtration techniques are increasingly considered.

The choice of techniques will therefore depend on factors including:

- the size and type of particles, including their settling properties
- the existing waste water treatment plant
- existing or planned changes in production and solutions (see Section 4.7.12)
- volume of waste water throughout
- the space available.

4.16.10.1 Sedimentation

Description of the three static sedimentation techniques

(1) Sedimentation tanks

Also called sedimentation or flat tanks, upward flow (for centre-fed circular tanks), horizontal flow (for rectangular tanks) with a scraper to move sludge to the bottom.

- advantages:
 - adapted to high flowrates
 - easy collection of sludges
 - good inertia to changes in effluent quality
- disadvantages:
 - difficult separation of the hydraulic flow into laminar flows
 - large structure (with large area) and sludge removal equipment may be complicated, therefore high cost
 - extraction of sludges can cause turbulence.

(2) Hopper bottom

Also called cylindro-conical or conical. Influent supplied through centre and downwards (but sufficiently far from the sludge not to affect the accumulated sludge. Steep sides (angle of cone must be $>60^\circ$) therefore no scrapers needed, extracted sequentially.

- advantages
 - simple design and equipment
 - sludge removal is easy, but sludge may accumulate on sloping sides (which can be overcome by a centrally driven scraper)
 - reduced maintenance
- disadvantages
 - not suitable for high flowrates
 - risk of sludge blockages.

(3) Laminar or tube settlers

Sedimentation tank where plates are used to enlarge the sedimentation surface

- advantages
 - small area, high capacity
- disadvantages
 - sensitive to the quality of flocculation and to load variations
 - sludges produced are not very thick, so a large volume sludge holding tank is required
 - frequent cleaning of the plates is required.

Achieved environmental benefits

Achievement of waste water emission limit values.

Recovery of sludges containing metal

Low energy usage, only pumping to require head (height).

Cross-media effects, Operational data, Applicability

See Descriptions, above

Economics

Site-specific

Driving force for implementation

Required to complete typical waste water treatment plants.

Reference literature

[21, Agences de l'Eau de France, et al., 2002, 87, EIPPCB,]

4.16.10.2 Flotation

Description

Solid particles (or liquid particles such as oil or grease) are combined with air bubbles producing particle/air clusters which float to the surface of a tank and are removed.

Achieved environmental benefits

Achievement of waste water emission limit values.

Recovery of sludges containing metal.

Possible reduction in anti-foaming agents, surfactants and activated carbon.

Cross-media effects

May require more coagulant than sedimentation.

Higher power consumption than sedimentation.

Operational data

Three methods are used:

- vacuum flotation, where air is dissolved at atmospheric pressure followed by a pressure drop to allow formation of bubbles
- induced air flotation, (IAF) where fine bubbles are formed and drawn into the waste water via an induction device such as a venturi or orifice plate
- dissolved air flotation (DAF) where pressurised air is dissolved into the waste water or part of the waste water and subsequently released as small bubble.

The advantages and disadvantages are:

- advantages
 - high efficiency
 - floatation speed greater than that obtained by static sedimentation, which implies smaller installations than static sedimentation.
 - pre-thickening of sludges.
- disadvantages
 - requirement for high quality flocculation to guarantee good adhesion of the air bubbles to the suspended solids
 - settings (for pressurisation) require monitoring.

Applicability

See Description above.

New and existing plants.

Economics

Site-specific

Smaller size allows more room for production capacity.

Driving force for implementation

Required to complete typical waste water treatment plant

Example plants

Industria Galvanica Dalla Torre Ermanno e Figli SpA, Fontane di Villaorba, Italy.

Reference literature

[21, Agences de l'Eau de France, et al., 2002, 87, EIPPCB,] (Personal communication, Lorenzo Dalla Torre)

4.16.10.3 Filtration

Description

For waste waters (not sludge dewatering) filtration is applied to:

- meet to meet emission values lower than can be met by sedimentation or flotation
- when considering revamping or updating waste water treatment to meet these lower values for changes in plant operation.

In conjunction with other objectives for recycling water and sludges

For a list and a summary of applications and references to descriptions of these techniques, see Section 4.10.

There are two categories of techniques:

(1) Traditional media:

Sand filters, upward or downward flow, by gravity or pressure

Other filter media, such as cellulose (see Section 4.11.1)

(2) Membrane filtering techniques

Tangential filtration: microfiltration and ultrafiltration (see Section 4.11.13.6)

Semi-permeable membranes: nanofiltration and reverse osmosis (see Section 4.7.8.2)

Economics

Site-specific

Driving force for implementation

Lower waste water emission values

Small size of technique

Enables water re-use and recycling.

Reference literature

[21, Agences de l'Eau de France, et al., 2002]

4.16.11 Combining techniques

Typical waste water treatment plants rely on a combination of techniques, see Section 2.13.1 and other sections of 4.16 for descriptions of typical waste water treatment plant.

Newer techniques can be combined for point source applications and combined flows (see Section 4.7.12)

4.16.12 Zero discharge techniques

Various techniques can be used in conjunction with water minimisation techniques (see Sections 4.6, 4.7 and Annex 8.5.9) to minimise discharges of all a processing line or an installation to zero. Note: this is different to closing the loop for one process chemistry within a line, see Section 4.7.11

Examples of techniques to achieve zero discharge are:

- thermal
- membrane
- ion exchange.

Description

The individual techniques are described under Sections 4.16.12.1 and 4.16.12.2.

Achieved environmental benefits

Reduction in all contaminants discharged.

Recovery of cleaned water for application in the process.

Cross-media effects

Energy for thermal techniques, pressure pumps and/or electrical power for membrane techniques.

Ion exchange resins require the consumption of other ions (Na, Cl, acids, alkali, depending on the resin type) in the same valency proportions as the ions they absorb.

The techniques can produce wastes that may be more toxic and/or difficult to handle than the sludges produced from a typical waste water treatment plant.

Applicability

It is generally easy and more environmentally efficient to achieve a closed loop for specific processes, such as nickel or chromium plating.

Economics

Although costs are site-specific, as zero discharge is approached, the costs for incremental discharge reductions can increase significantly in proportion to the benefits achieved.

4.16.12.1 Thermal procedures

As well as the classical waste water treatment by chemico-physical procedures, it is possible to avoid the discharge of waste water completely by the use of evaporation techniques. Instead of the metal hydroxides, a mixture of water-soluble salts results from evaporation, whose disposal requires a deposit in a suitable landfill, possibly with solidification.

At present, two basic techniques are available for evaporation of the effluent:

- vacuum evaporators with vapour compression and
- infrared evaporators at atmospheric pressure.

4.16.12.1.1 Vacuum evaporators with vapour compression

Description

By the use of vacuum evaporators with vapour compression it is possible to lower the energy demand to an economic level.

Achieved environmental benefits

Zero water discharge can be achieved from an installation or from certain process steps

Cross-media effects

Increased energy usage in evaporation and concentrate drying. Waste produced may be more difficult to manage than conventional sludges.

Cyanide can be evaporated with the water.

Operational data

The evaporator produces a concentrate which requires an additional drying procedure. Thus the investment and operating cost rises to an extent where this technology is usually only economic in exceptional cases.

The water quality produced is very high, with conductivity from 90 mS to 200 μ S.

Applicability

This is only technically possible by the use of a large energy input and high capital plant investment. There may little or no environmental benefit or requirement to clean a waste water discharge containing 'neutral' salts (i.e. alkali metal salts, Na, K, Ca) left from traditional treatments. There are three possible cases:

- **small effluent quantity:** effluent quantity may be drastically reduced by in-plant measures described in Sections 4.6 and 4.7. The concentration of the soluble contents then rises accordingly. It may then become difficult to treat the effluent by classical methods and be difficult to meet strict concentration values for effluent and sewage regulations. In such a case, evaporation can be more economic than conventional treatment, despite the energy consumption
- **ingredients difficult to remove by normal operation** complexing agents such as EDTA are difficult to destroy in the effluent. However, their use is essential for some processes and specifications. For an installation which relies on using such chemicals, the complete evaporation of the relevant flows may be the only solution
- **regulation:** an enterprise whose production has no waste water discharge may be free from, or less subject to, supervision by the environmental regulatory authorities and any related costs.

Economics

See Operational data.

Driving force for implementation

See Applicability.

Example plants

See Annex 8.5.8 and Annex 8.13.

Reference literature

[104, UBA, 2003] [124, Germany, 2003, 128, Portugal, 2003].

4.16.12.1.2 Infrared evaporators

Description

The liquid to be evaporated is placed in a conical container. The liquid surface is then warmed with infrared radiation produced by a gas infrared emitter. Controlled and bubble-free evaporation is achieved by radiation absorption as the liquid presents an extremely thin layer at the 'shallow end'. The crystallised solids sink in the residual water because of their higher specific gravity in the 'cold' layers of the evaporator. The crystal mash formed is discharged via a valve to a filter bag. The filtered mother liquor is fed back to the evaporator vessel. The water vapour mixture leaves the evaporator by an extraction system.

Achieved environmental benefits

Zero discharge from all or part of an installation.

Cross-media effects

Increased energy usage in evaporation; the energy consumption of 100 m³ natural gas per m³ of water evaporated is high.

Waste produced may be more difficult to manage than conventional sludges.

Ammonia may be volatilised into the air.

Operational data

Advantages of this technique:

- durable, resistant technology
- direct, contact-less heating
- clean exhaust gas because of aerosol evaporation
- consistent performance with salt solutions, acids and alkalines
- fully automatic salt discharge possible
- reducing or oxidising atmosphere in the evaporator area as required
- no pollution and/or encrustation problems
- no additional chemicals needed, for example for cleaning purposes
- very high plant throughput availability due to safe continuous operation
- Cr(VI) reduction is possible without additional chemicals
- evaporating on ammonia solutions without effluent problems
- noiseless operation.

Applicability

See Section 4.16.12.1.1.

Economics

Capital costs are likely to be lower than for a typical waste water treatment plant operated to BAT standards. High running costs, although a combination of infrared evaporator and reverse osmosis reduces the energy costs

Driving force for implementation

See Applicability.

Reference literature

[124, Germany, 2003] [104, UBA, 2003, 113, Austria, 2003]

4.16.12.2 Membrane technologies with physico-chemical processes

Thermal procedures present advantages when considering the quality of the treatment (allowing for recycling). However, the investment and operating costs are more significant [55, France, 2003].

The classical waste water treatment by physico-chemical procedures can be improved using membranes technology. At present, there are two basic technical solutions using membranes:

- ultrafiltration, obtaining very low concentrations in metals and organics (e.g. Ni concentration after treatment by ultrafiltration can be lower than 0.1 mg/l) rather than with classical physico-chemical treatment, when it is very difficult to reach 0.5 mg/l for waste water from nickel plating. However, a chemical treatment is necessary before ultrafiltration, such as hydroxide or sulphide precipitation
- combining ultrafiltration and reverse osmosis allowing 'zero water discharge'.

4.16.12.2.1 Treatment using ultrafiltration

Description

The main difference between classical physico-chemical treatment and ultrafiltration treatment is the use of membranes instead of settling. Some metals in solution may need treatment with reducing agents before ultrafiltration.

Achieved environmental benefits

Zero water discharge from all or part of an installation when concentration of dissolved products allows recycling.

No suspended solids.

The concentration of metals is much lower than with the classical procedures.

Increasing the treatment capacity only requires more membrane units.

Cross-media effects

Problems of clogging in relation to membranes which needs different plant management.

Wastes generated from treatment.

Operational data

Uses little space compared with some other techniques.

Applicability

This technique may also be considered for:

- very high quality treatment requirement (recycling requirements and strict environmental quality standards)
- medium and large projects, this technique will provide an excellent quality (suspended solids close to zero, very low metals concentration, reduced COD etc)
- an old waste water treatment plant being revamped (for discharge quality and/or capacity of treatment) implementing ultrafiltration in place of settlement, as it provides a high quality level of treatment with reduced investment and in reduced space.

This technique is less applicable where there is a low volume to treat or for highly concentrated waste water (high TDS).

Economics

Important economy on investment and operating cost levels in comparison with thermal procedures.

Driving force for implementation

See Applicability, above.

Examples plants

About 80 plants have been working for six years in western Europe.

Reference literature

[156, France, 2003]

4.16.12.2 Treatment using combination of ultrafiltration and reverse osmosis**Description**

The treatment in a first step is based on ultrafiltration (see Section 4.16.12.2.1), followed by reverse osmosis in a second step, see Figure 4.32. This reduces salt and organic concentrations in order to obtain a very high quality water, permitting recycling for very sensitive uses.

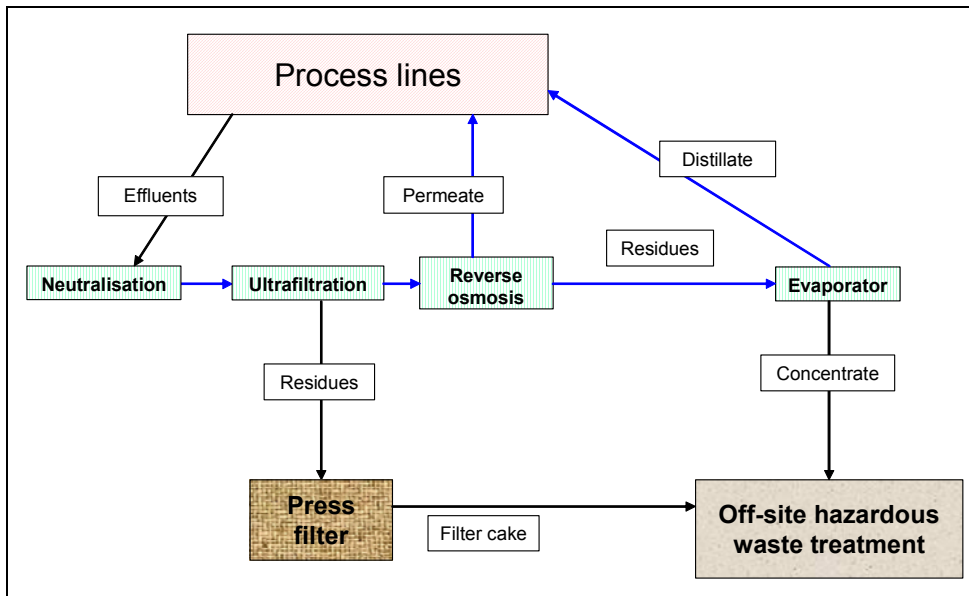

Figure 4.32: Treatment using a combination of ultrafiltration and reverse osmosis [55, France, 2003]

Achieved environmental benefits

Zero water discharge.

The technical solution generates two different qualities of water for recycling (medium quality for secondary functions and high quality for sensitive functions such as final rinsing by spray). This use of two different qualities of recycled water reduces operating costs.

Cross-media effects

More complex solution (different stages). Not adapted for very small projects or high concentrations.

Can produce concentrated wastes.

Operational data

Advantages of this technique:

- very high level of quality
- low investment and operating costs
- easy possibility of graduation in the treatment quality (after ultrafiltration or after reverse osmosis)
- possibility of evolution of the treatment capacity
- very compact unit (low height and/or small area where these are limiting factors).

Economics

Important reduction for investment and operating costs in comparison with thermal procedures.

Driving force for implementation

See Applicability.

Example plants

Four plants working in France with this technique (the first one since 2001).

Reference literature

[55, France, 2003]

4.16.13 Monitoring, final control and discharging of waste waters

Prior to discharge, the effluent is checked to ensure it complies with local permit conditions in line with a monitoring programme, see Annex 8.4, and the BREF on the general principles of monitoring [91, EIPPCB,].

Discharge may be:

- continuous with:
 - continuous online monitoring for key parameters such as pH
 - frequent manual checking of key parameters, such as pH, metals, cyanide (as appropriate to the installation's activities)
 - a combination of both.
- batch discharge with prior checking for key parameters such as pH, metals, cyanide (as appropriate to the installation's activities). This is required in Germany [124, Germany, 2003].

Both options can form part of a management system (see Section 4.1.1) and when the effluent falls outside of the limit values, action can be initiated. This may be instigated by automatic alarms with online systems, or manually with manual checking.

Description

It is advisable to design the monitoring programme to ensure that the installation meets its permit requirements.

Achieved environmental benefits

Meeting permit requirements.

Cross-media effects

For continuous discharges, poorly trained, poorly maintained and/or inspected online systems or lack of sufficient manual inspection and analytical results can allow the discharge of out-of-limit effluents.

For batch discharges, poorly trained supervision, or supervision without adequate analytical results can allow the discharge of out-of-limit effluents.

Operational data

Staff carrying out this function need adequate training supported by adequate analytical information, whether from online monitoring, 'spot tests' or laboratory results.

Staff carrying out manual monitoring may be easily distracted from completing testing and inspection.

Online monitoring equipment needs regular maintenance and calibration by appropriately trained staff.

Applicability

All sites discharging to watercourses or public or central waste water treatment systems.

Economics

Continuous discharge with regular manual inspection may appear cheapest. However, this must be compared with the risk and costs of breaches in permit conditions.

Online monitoring equipment must be regularly maintained for the same reasons, but may recover the cost of manual inspections in a relatively short time.

Batch discharge after testing is expensive in capital investment in tanks sufficient to take a flow period, or possibly two or more tanks operated in sequence. This also requires inspection and analysis prior to discharge.

Driving force for implementation

Compliance with environmental legislation.

Example plants

In Germany, all surface treatment plants with effluent operation on a batch basis.
For France, see monitoring, in Annex 8.4.

Reference literature

[124, Germany, 2003] [56, France, 2003, 91, EIPPCB, , 104, UBA, 2003]

4.17 Waste management techniques

4.17.1 Generation and management of waste

Annex IV (point 3) of the IPPC Directive requires the operator to '*further the recovery and recycling of substances generated and used the process and of waste, where appropriate*'.

The rinsing processes in surface treatment installations produce rinse-waters containing concentrates. In addition to rinse-waters, the following waste waters streams can also contain metals:

- used process solutions from the electrochemical processes (electrolytes)
- used process solutions from chemical coating processes
- used process solutions from the pre- and post-treatment (cleaning, pickling, phosphating and chemical conversion)
- solutions from separation and regeneration processes, such as ion exchange, retardation, dialysis, electrolysis
- solutions from associated activities, such as exhaust scrubbers and filters, as well as from plant cleaning.

Generally the solutions and effluents are discharged into the effluent system. The treatment of the streams containing metal in the system essentially precipitates the dissolved metal ions as insoluble compounds. Normal precipitation with caustic soda solution and/or lime precipitates the metals as hydroxides and/or oxide hydrates. Precipitation may also be as carbonates and sulphides. The sludge produced has a water content of usually over 95 % and is drained by means of filter presses to about 60 % water content and is disposed of in this form as sludge.

The amount of sludge depends on various processing factors:

- contamination of the input material
- amount of metal oxides dissolved or eroded from the workpiece/substrate surfaces
- discharge of process solution dragged-out by the workpieces/substrate
- service lifetime of the process solutions.

That means that the generation of sludge without internal recycling measures is directly proportional to the drag out and the service lives of the process solutions. Generally, the metal losses by drag out related to the metal input material lies between 5 and 30 %.

Surface treatment sludge is usually a mixture of metal hydroxides. It contains all non-ferrous metals used during the process, the workpiece substrate metals iron and aluminium, as well as calcium, potassium and sodium from the precipitation chemicals.

Depending on the plating process, the non-ferrous metal contents (Cu, Ni) can amount to up to 30 %, for example, with monosludges (i.e. sludges from one process type only). The major part of the electroplating sludge is a mixture and has non-ferrous metal contents of about 10 %, as Table 4.19 shows.

	Cu %	Ni %	Zn %	Pb %	Cr %	Fe %	Ca %	Cl %	SO ₄ %	Water %
Cu sludge	5 - 10	1 - 5	1 - 5	0 - 1	0 - 2	5 - 15	2 - 10	0 - 3	0 - 20	50 - 70
Ni sludge	0 - 2	10 - 15	1	0 - 1	0 - 2	0 - 5	0 - 5	0 - 3	0 - 5	50 - 70
Mixed sludge	0 - 2	0 - 2	2 - 3	0 - 1	0 - 2	5 - 15	5 - 15	0 - 3	5 - 20	50 - 70

Table 4.19: Typical composition of electroplating sludge from different sources
UBA

Some liquid wastes, such as end-of-life electrolytes or layer conversion solution may also be concentrated and treated in the in-house waste water treatment plant.

Other wastes can be re-used or recycled externally, see 4.17.3. In order to facilitate this, it may be good practice to separate or concentrate certain waste streams, to increase or maintain their usefulness.

4.17.2 Waste minimisation and avoidance

There are four key factors for the avoidance and minimisation of waste in surface treatment processes, and they are described in the appropriate sections:

- reducing the amount of hazardous material in the waste, see Substitution, in Section 4.9
- extension of the service lifetime of the process solutions, see Process Solution Maintenance, in Section 4.11
- decrease of the drag-out of process solutions, see Section 4.6
- feedback of the dragged-out process solutions into the process tanks, see Section 4.7.

4.17.3 Re-use and recycling of waste

Description

Wastes that cannot be recovered internally may be valorised externally by third parties.

To assist with this, it may be good practice to keep these waste streams separate to maintain a concentration of components that makes recovery viable or to prevent contamination, such as contamination of aluminium hydroxide sludge with heavy metals.

The following are examples of external valorisation:

- hydro and pyrometallurgical companies engaged in non-ferrous metal refining. Part of the electroplating sludge may have a high value material content and recycling by third parties can be arranged in many cases. Recycling includes refining of the metals copper, nickel, chromium and zinc from suitable electroplating sludge as metals or metal compounds
- manufacture of usable metal concentrates
- phosphoric and chromic acids, spent etching solutions, etc.
- aluminium hydroxide from anodising can be precipitated and recycled, for example as a coagulant for sewage treatment. (Note: the rinsing waters from colouring and sealing processes may contain heavy metals and it is advisable to collect sludge separately from these waste water streams if re-use is required)
- inorganic chemical companies and the glass and ceramics industry which use metals or metal compounds intentionally in the manufacture of products.

Techniques where the metals are merged non-specifically into mineral matrices (glass, ceramics, cement) are not considered recycling, but may be an option. Note that European legislation now controls the amount of hexavalent chromium in cement.

In the surface treatment installation used electrolytes, coating and conversion solutions which are no longer suitable for regeneration become liquid waste. These solutions can be transferred under certain conditions to the chemical suppliers for re-use in the direct manufacture of new electrolytes.

The preferred aim is the recovery for use of the raw material, i.e. winning the metals copper, nickel and zinc from the redundant electrolytes. This technique also exists in principle for semi-concentrates such as the contents of the static rinses. It may be favourable to further concentrate these strong solutions by evaporation or other concentration techniques which lowers the transport costs and at the same time increases the valuable material content.

Achieved environmental benefits

Recovery of commodity metals which are conservative (i.e. non-degradable).

Re-use of materials instead of discarding them.

Replacement of fresh raw materials by re-used ones.

Cross-media effects

Emissions from, and energy used in recovery processes.

Chemicals used to achieve a suitable waste for reprocessing.

Operational data

It is advisable to consider the balance of recovery and recycling. For instance, some in-process re-use in the process solution may recover a small amount of metal, but reduce the metal content of the installation's sludge below the environmental and economic recovery breakeven point. The sludge then disposed of may still contain more metal than could have been recovered.

Recycling opportunities are favoured if the streams within the effluent system are kept separate according to their metal contents. The amount of separation applied depends on the requirements of the recycling companies.

Copper, nickel, chromium and zinc are regularly recovered. Some small quantities of precious metals, tin, lead and cadmium also arise. Sodium and calcium occur as precipitating chemicals. Re-use is technically possible if sludges are produced by appropriate pre- or post-treatment measures which satisfy the requirements of recycling plants in their consistency and material composition. These requirements include:

- physical parameters such as consistency and water content
- meeting or exceeding the minimum content of usable metals
- producing a mixture of metals which is usable
- minimum content of substances which disturb the recycling process.

The requirements of the recycling plants for consistency and composition of the electroplating sludge differ substantially from each other, depending on the particular recycling process and require assessing on a case by case basis.

Applicability

Dependent on the availability of suitable re-use options and the suitability of the sludge.

For instance, recovered chromium oxides with high chloride content may not be suitable for recovery of the chromium in some processes.

Transport (distance to the recycler) may also be a factor.

Economics

Case dependent.

Cost of disposal of surface treatment wastes, which are usually classed as hazardous.

Driving force for implementation

Increasing disposal costs for hazardous wastes.

Example plants

WRC GmbH, Wurzen (Germany)

Reference literature

[104, UBA, 2003], [30, EC, 2003, 152, ESTAL, 2004, 155, EIPPCB,], [89, EIPPCB,]

4.17.4 In-house electrolytic recovery

See Section 4.11.9.

4.18 Air emission abatement techniques

Chapter 2 identifies processes which lead to emissions of concern, for example: pickling, certain etching processes, brightening, certain plating tanks, etc. Typical substances emitted to the air are described in Section 3.3.3. For workers' health and safety it is often necessary to limit certain emissions inside surface treatment installations: whilst the overall potential emission load to the environment does not change, emission abatement techniques, such as scrubbing, may have cross-media impacts (for example to waste water and in energy consumption). Good environmental practice in preventing emissions can be complementary to occupational health objectives.

It is widespread practice to minimise the amount of humid and/or corrosive fumes. This not only protects employee health, but also:

- protects workpieces or substrates in storage or in the various stages of processing, see Section 4.3.1
- protects the installation infrastructure
- protects control systems in process control and other sensitive equipment (computers, etc).

[80, INRS, , 104, UBA, 2003]

Some or all of these measures may be used together.

Where the extracted air contains materials that may cause environmental harm (as described in the appropriate processes in Chapters 2 and 4), the air can be treated by options described in Section 2.13.3.4

4.18.1 Additives**Description**

According to manufacturer's data, in pickling solutions, the formation of nitrite ions and Cr(VI) ions are prevented by pickling additives. The emissions of HF and NO_x can also be reduced so that it is not necessary to install an exhaust air scrubber.

It is also possible to be reduce or prevent Cr(VI) aerosol emissions from chromium plating tanks by the use of fluorinated additives but note that these are based on PFOS, see Section 1.4.4.4 and Annex 8.2. Aerosols from alkaline etching or anodising can be prevented by using surfactants. For both processes there are unfluorinated surfactants which are used with success.

Achieved environmental benefits

Reduced formation of harmful species, therefore reducing their concentration and emission.
Prevention of the formation of harmful mists or aerosols (especially for Cr(VI) plating).
Air extraction may not be needed as a foam layer may be formed which is sufficient to minimise the release of hazardous substances to air.

Cross-media effects

PFOS (polyfluorinated octyl sulphonate) is used in suppressing Cr(VI) mists, and in other applications. It is toxic, bio-accumulative and persistent (see Annex 8.2).

Operational data

Additives can also improve product quality.

Applicability

See individual applications.

Economics

May in some cases achieve sufficiently low emissions without the need for air extraction and/or reduce the size, complexity and cost of extraction equipment.

Driving force for implementation

Occupational health and safety legislation as well as emission limit values.

Example plants

Reference literature

[3, CETS, 2002, 113, Austria, 2003, 159, TWG, 2004]

4.18.2 Air extraction, lids and treatment techniques

Overall description

Covering the tanks when either the immersion time for a jig or barrel needs extended time or the baths are not used minimises the emissions to the workplace atmosphere, and subsequently to the environment. Containing the air space above the vat by using lids reduces the amount of air to be withdrawn and treated. A description of some options for lids is given in this section and an example can be seen in Figure 4.33.



Figure 4.33: Jig line with lids on vats and air extraction
Graindorge S.A. and Agence de l'eau Seine-Normandie

Containment is discussed in several BREFs (see Reference Literature). The containment of the sources of potential emissions minimises the amount of emission and airflow, although the airflow may need treatment.

Edge exhausts are normally employed to meet industrial health and safety requirements and various configurations are described in Section 4.18.3.

The quantity of exhaust air sucked off by the edge exhaust, and the quantity of pollutants it contains are influenced by the following parameters:

- tank size
- continuous or intermittent operation of the bath
- bath temperature
- physico-chemical characteristics of the assigned chemicals
- classification and permissible concentration at the workplace
- use in conjunction with pickling additives to decrease and/or avoid of the emissions of HF and NO_x gases and Cr(VI) aerosols
- emission control procedures, etc.
- types, size and density of particulates
- the space between the exhaust slots and the surface of the vat
- the strength of the electric currents in electrolytic processes
- the type of bath agitation used (such as air, pumped recirculated flow or eductor).

The pollutants emitted with the drawn off exhaust air are separated where necessary to achieve emission standards by the following exhaust air cleaning devices:

- exhaust air scrubbers with fill materials and droplet separators
- exhaust air scrubbers with the following combinations:
 - cyanide and acid separation in an alkaline scrubber
 - nitrogen oxides and hydrofluoric in an acid scrubber
 - exhaust air containing Cr(VI) by droplet separators
- mist filters used for aerosols and droplets, such as Cr(VI)
- droplet separators for aerosols and droplets, such as Cr(VI), which may be followed by filters
- cyclones, electrostatic precipitators or filters (for examples for dusts from mechanical polishing).

These are described in the BREF on waste water and waste gas treatment in the chemical sector for extraction systems.

Organic solvents, such as VOCs from solvent degreasing, are emitted, they are discussed with in the BREF on the surface treatment using solvents.

The industry generally produces a small source of NO_x. Major uses are in pickling and brightening, and emissions are low with typical air scrubber systems, without the need for catalytic reduction (see Economics below and Annex 8.12).

In the case of some combinations of different systems, there are slight deviations to the exhaust air purification measures described above.

Overall achieved environmental benefits

Additives can decrease the formation of gases and Cr(VI) aerosols and may extend the life of pickling acids.

Lids reduce the amount of gases and aerosols emitted to the air.

Section 3.3.3 show that the use of simple extraction systems using droplet separators and/or counter-flow scrubbing readily achieved normal target values.

No data are available for the effectiveness on emissions of the other process measures (additives and lids).

Overall cross-media effects

Air extraction can have a significant effect on power consumption in three ways:

- additional electricity to power fans and pumps
- unwanted loss of heated workspace air during working periods when outside temperatures are below about 12 °C (this may be more significant in Northern and Central Europe)
- unwanted cooling of process solutions by increasing evaporation requiring additional process energy input.

Additives may be harmful to health and the environment, see Section 1.4.4.4 and Annex 8.2.

Overall operational data

Options to reduce the volume of extracted air and decrease the energy losses are discussed in Section 4.18.3, below.

Overall applicability

One or more of these options is suitable for all installations.

Overall economics

It is not cost-effective for the industry as a whole to install catalytic reduction for NO_x, see Annex 8.12.

Overall driving force for implementation

Workplace health and safety.

Reference literature

[66, PPRC, 2003, 80, INRS, 104, UBA, 2003] [87, EIPPCB, , EIPPCB, #155, EIPPCB, #86] [90, EIPPCB,].

4.18.3 Reduction of the volume of extracted air

General description

The most common system uses extraction hoods located laterally to the entrance area for plating jigs on flight bars and plating barrels above processing vats, see Figure 4.34.

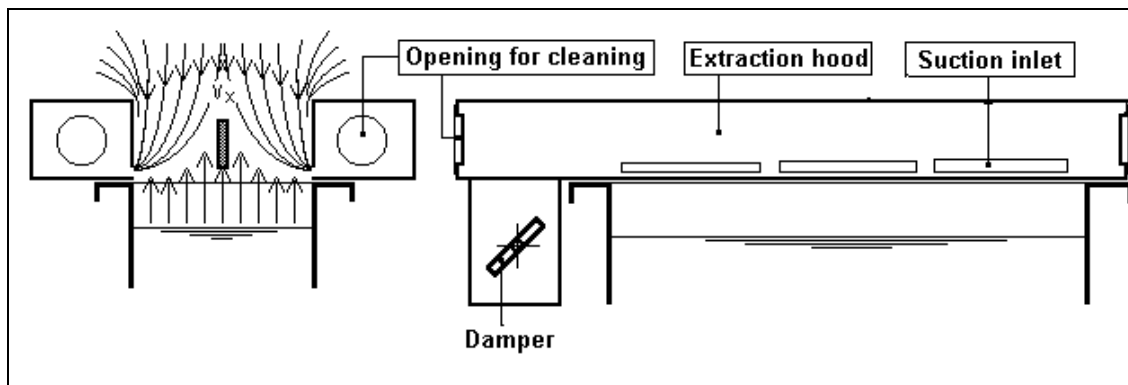

Figure 4.34: Example of fume extraction on top of treatment tank

The efficiency of the air extraction is determined by the minimal air velocity (v_x) necessary to capture the uprising vapour, fumes or aerosols at the most distant point from the extraction hood.

Values for v_x differ between 0.2 m³/s capture velocity for moderate water vapours and 0.5 m³/s for aerosols from hard chromium plating solutions.

The volume of air to be extracted depends on the free surface area of the processing solution.

It can be calculated by the following equations:

$$\text{Single-sided extraction (} W < 0.5 \text{ m)} \quad V = 2 v_x L W (W/L)0.2$$

$$\text{Double-sided extraction (} W > 0.5 \text{ m)} \quad V = 2 v_x L W (W/2L)0.2$$

V = volume of extracted air, m³
 v_x = minimal air velocity at point x, m³/s
 L = length of extraction area, in metres
 W = width of extraction area, in metres.

Single-sided extraction is normally used for tanks of width $W < 0.5$ m, see Figure 4.35, and double-sided extraction for wider tanks ($W > 0.5$ m), see Figure 4.36.

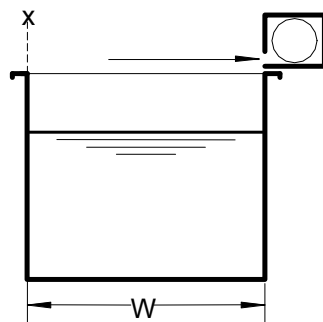

Figure 4.35: Single-sided extraction ($W < 0.5$ m)

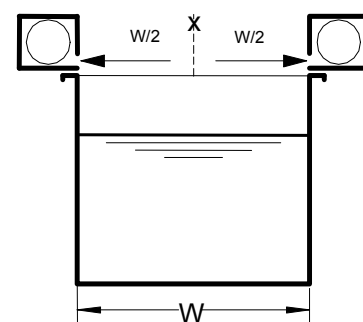

Figure 4.36: Double-sided extraction ($W > 0.5$ m)

There are three options to reduce the volume of extracted air:

(1) Reduction of free surface area above tanks

Figure 4.37 and Figure 4.38 show different means of minimising the air volume extracted and thus energy consumption.

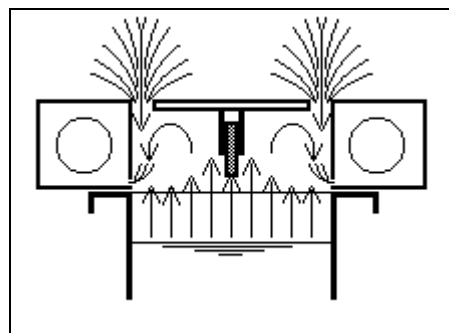

Figure 4.37: Lid protecting free surface area, fixed to and moved with the flight bar

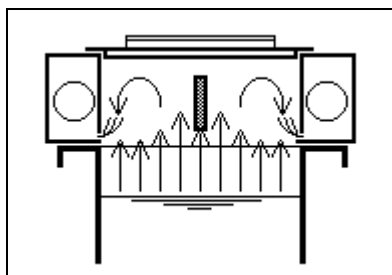

Figure 4.38: Lid protecting free surface area above extraction hood, movable by the transporter

Figure 4.37: Since hazardous fumes or aerosols are generated mainly during processing, lids fixed to and moved with the flight bar are a suitable means for reducing the volume of extracted air by 60 – 75 % of the normal rate without a reduction in the surface area.

Figure 4.38: These lids cover all process stations where vapour, fumes or aerosols are generated at any time except during loading and unloading of the stations. The reduction in extraction rate increases may be more than 90 % (subject to a German patent). A major advantage of this system is that these lids need no drive at the station itself, since they are moved simultaneously with the drip tray of the transporter.

Lids hinged to the tank, driven individually and automatically opening and closing when jigs and barrels enter and leave the processing tank are another appropriate but more expensive design. Usually this system is combined with a device designed to automatically increase the volume of extracted air when the lids are opened. A reduction in extraction rate of up to 90 % may be achieved.

(2) Push-pull system

This method is designed to create an airflow over the surface of the processing bath. It works with an extraction hood opposite a blowing duct. The surface of the processing solution must not have any frame or obstacle to the airflow. Therefore its application remains quite limited.

(3) Enclosure of the plating line

Recently, the complete segregation of the process plant has been achieved in some installations.. The plating line is installed inside an enclosure, while all plant operations, the plant management systems, and the loading/unloading stations are located outside; see Section 4.2.3. Since a substantial amount of extracted air is still necessary to prevent corrosion of the equipment within the enclosure, an energy saving higher than the figures for other techniques cannot be expected.

Achieved environmental benefits

Reduction of the volume of extracted air reduces energy consumption and any required treatment processes, chemicals, etc.

Applicability

Attention needs to be paid to energy efficiency in all installations using air extraction. Process control is feasible for all installations. Other options will be site-specific.

Where the processing line is enclosed, the maintenance of the plant and solutions may become more complicated and time-consuming. This technique is likely to be most effective with new installations, rather than retrofitting.

Economics

Case-specific, but see the Example Plant below where the operational savings gave a two year payback, and one year payback if capital savings are included.

Driving force for implementation

Health and safety in the work place.

Example plant

See Annex 8.9, Goodrich Aerospace Landing Gear Division, Tullahoma, Tennessee, US,

Reference literature

[3, CETS, 2002, 113, Austria, 2003]

4.18.4 Treatment of extracted air

Treatment options are described in Section 2.13.3.

4.18.5 Air extraction control techniques**Description**

Air extraction can be operated during operating periods for the solutions of concern, and when conditions require, such as when process solutions are fully heated and working. Care may be taken that the air extraction system does not operate when it is not required, especially when outside temperatures are low and/or workplace cooling or heating are functioning. Timers can be installed.

Achieved environmental benefits

Energy saving.

Applicability

Process control is feasible for all installations.

Economics**Driving force for implementation**

Cost saving.

Reference literature

[3, CETS, 2002]

4.18.6 Energy recovery from extracted air**Description**

The exhaust air is passed through a heat exchanger. The capital investment and operating costs are very high. Savings from energy recovery are only a fraction of these costs, a feasibility study prior to installation including economic considerations is essential to ensure sound investment. More information is given in the BREFs on Waste Water and Waste Gas Management Systems and Surface Treatments using Solvents.

Achieved environmental benefits

Energy recovery.

Operational data

Attention needs to be paid to energy efficiency in all installations using air extraction.

Applicability

This energy saving measure is limited to installations of large size and/or with large volumes of warm air being extracted.

Reference literature

[3, CETS, 2002, 87, EIPPCB, , 90, EIPPCB,]

4.19 Noise management

Description

It is good practice to reduce noise from the installation so impact upon the local community is not significant. Noise can be eliminated or reduced at source (in-process), such as extracting hydrogen produced by electrolysis and so preventing explosions across the top of vats with certain electrolytic processes. Delivery transport can also have an impact locally, and can be managed by reducing deliveries and/or managing delivery times.

Noise reduction can be achieved through engineering noise control measures where required, such as installation of silencers to large fans, use of acoustic enclosures where practicable for equipment with high or tonal noise levels, etc.

Effective plant operation includes closure of bay doors.

Achieved environmental benefits

Reduced noise.

Cross-media effects

Use of silencers can lead to an increase in energy as pressure drops increase.
Closing bay doors can increase demands on internal ventilation and cooling.

Operational data

Site-specific

Applicability

To new and existing plants.

Economics

Case specific, but usually no payback. Increased cost of ventilation with workplace doors closed.

Driving force for implementation

Prevention of noise complaints. Compliance with occupational health legislation.

Example plants

SOFRA-PCB, Mennecy, France.

Reference literature

[19, Eurofer, 2003], [115, CETS, 2003].

5 BEST AVAILABLE TECHNIQUES

In understanding this chapter and its contents, the attention of the user/reader is drawn back to the preface of this document and in particular the fifth section of the preface: ‘How to understand and use this document’. The techniques and associated consumption and/or emission levels, or ranges of levels, presented in this chapter have been assessed through an iterative process involving the following steps:

- identification of the key environmental issues for the sector; surface treatment of metals and plastics. These are related to:
 - management systems and construction of the site
 - water and raw materials usage and emissions
 - substitution for hazardous materials
 - energy usage
 - site contamination on cessation of activities
- examination of the techniques most relevant to address these key issues
- identification of the best environmental performance levels, on the basis of the available data in the European Union and worldwide
- examination of the conditions under which these performance levels were achieved; such as costs, cross-media effects, and the main driving forces involved in implementation of the techniques
- selection of the best available techniques (BAT) and the associated consumption and/or emission levels for this sector in a general sense, all according to Article 2(11) and Annex IV of the Directive.

Expert judgement by the European IPPC Bureau and the relevant Technical Working Group (TWG) has played a key role in each of these steps and in the way in which the information is presented here.

On the basis of this assessment, techniques, and as far as possible consumption and emission levels associated with the use of BAT, are presented in this chapter that are considered to be appropriate to the sector as a whole and in many cases reflect the current performance of some installations within the sector. Where consumption or emission levels ‘associated with best available techniques’ are presented, this is to be understood as meaning that those levels represent the environmental performance that could be anticipated as a result of the application, in this sector, of the techniques described, bearing in mind the balance of costs and advantages inherent within the definition of BAT. However, they are neither consumption nor emission limit values and should not be understood as such. In some cases it may be technically possible to achieve better consumption or emission levels but due to the costs involved or cross-media considerations, they are not considered to be appropriate as BAT for the sector as a whole. However, such levels may be considered to be justified in more specific cases where there are special driving forces.

The consumption and emission levels associated with the use of BAT have to be seen together with any specified reference conditions (e.g. averaging periods).

The concept of ‘levels associated with BAT’ described above is to be distinguished from the term ‘achievable level’ used elsewhere in this document. Where a level is described as ‘achievable’ using a particular technique or combination of techniques, this should be understood to mean that the level may be expected to be achieved over a substantial period of time in a well maintained and operated installation or process using those techniques.

Where available, data concerning costs have been given together with the description of the techniques presented in the previous chapter. These give a rough indication about the magnitude of the costs involved. However, the actual cost of applying a technique will depend strongly on the specific situation regarding, for example, taxes, fees, and the technical characteristics of the installation concerned. It is not possible to evaluate such site-specific factors fully in this document. In the absence of data concerning costs, conclusions on economic viability of techniques are drawn from observations on existing installations.

It is intended that the general BAT in this chapter are a reference point against which to judge the current performance of an existing installation or to judge a proposal for a new installation. In this way they will assist in the determination of appropriate 'BAT-based' conditions for the installation or in the establishment of general binding rules under Article 9(8). It is foreseen that new installations can be designed to perform at or even better than the general BAT levels presented here. It is also considered that existing installations could move towards the general BAT levels or do better, subject to the technical and economic applicability of the techniques in each case.

While the BAT reference documents do not set legally binding standards, they are meant to give information for the guidance of industry, Member States and the public on achievable consumption and emission levels when using specified techniques. The appropriate limit values for any specific case will need to be determined taking into account the objectives of the IPPC Directive and the local considerations.

The BAT summarised below are applicable to existing and new plants, unless otherwise stated. The feasibility of implementing a technique is, however, also driven by other factors to be considered, such as higher relative cost to smaller installations, limitations of some techniques, available space and infrastructure at a site (such as waste water treatment plants).

Some key findings to help users/readers of this document

During the preparation of this document, several important issues became apparent when considering the key environmental issues:

- although the industry is complex in the size and range of activities, the same key environmental issues apply to all. The techniques applied to address these issues are also wide-ranging, and often transferable. This section is therefore split into those BAT that are generic and those that are specific to certain activities
- in exceptional cases, the generic BAT do not apply to certain specific activities and these are noted
- it is strongly recommended to read Chapter 4 in conjunction with this chapter. To help the reader, references to Chapter 4 have been included in this Chapter 5.

When interpreting the consumption and emission levels or ranges associated with BAT given in this chapter it is essential that the user/reader understands that:

- these consumption or emission ranges are not the same as emission limit values (see the introduction to this chapter, above)
- across the EU-25, ELVs are set and enforced in different ways
- for a particular installation, lowering an emission level within the consumption or emission range may not represent BAT overall (when considering costs and cross-media effects) and that antagonism may exist between BAT, i.e. lowering one may increase another. For these reasons, an installation may not operate with all parameters at the lowest levels in all the ranges.

5.1 Generic BAT

5.1.1 Management techniques

Environmental management, housekeeping and maintenance systems

There are number of techniques related to the continuous improvement of environmental performance. They are intimately linked with good practice in the areas of designing, building, operating and maintaining an installation for optimal efficiency. These techniques provide the framework for ensuring the identification, adoption and adherence to BAT options that, while often down-to-earth, remain important in improving environmental emissions. Indeed, housekeeping/maintenance/management techniques often prevent emissions.

A number of management techniques are determined as BAT. The scope (e.g. level of detail) and nature of the system (i.e. such as for EMS, whether it is standardised or non-standardised) will generally be related to the nature, scale and complexity of the installation, and the range of environmental impacts it may have.

5.1.1.1 Environmental management

BAT is to implement and adhere to an Environmental Management System (EMS) that incorporates, as appropriate to individual circumstances, the following features: (see Section 4.1.1):

- definition of an environmental policy for the installation by senior management (the commitment of the senior management is regarded as a precondition for a successful application of other features of the EMS)
- planning and establishing the necessary procedures
- implementation of the procedures, paying particular attention to:
 - structure and responsibility
 - training, awareness and competence
 - communication
 - employee involvement
 - documentation
 - efficient process controls
 - maintenance programmes
 - emergency preparedness and response
 - safeguarding compliance with environmental legislation
- checking performance and taking corrective action, paying particular attention to:
 - monitoring and measurement (see also the Reference document on Monitoring of Emissions)
 - corrective and preventive action
 - maintenance of records
 - independent (where practicable) internal auditing in order to determine whether or not the environmental management system conforms to planned arrangements and has been properly implemented and maintained
- review by senior management.

Three further features, which can complement the above stepwise, are considered as supporting measures. However, their absence is generally not inconsistent with BAT. These three additional steps are:

- having the management system and audit procedure examined and validated by an accredited certification body or an external EMS verifier
- preparation and publication (and possibly external validation) of a regular environmental statement describing all the significant environmental aspects of the installation, allowing for year-by-year comparison against environmental objectives and targets as well as with sector benchmarks as appropriate
- implementation and adherence to an internationally accepted voluntary system such as EMAS and EN ISO 14001:1996. This voluntary step could give higher credibility to the EMS. In particular EMAS, which embodies all the above-mentioned features, gives higher credibility. However, non-standardised systems can in principle be equally effective provided that they are properly designed and implemented.

Specifically for this industry sector, it is also important to consider the following potential features of the EMS:

- the environmental impact from the operation and eventual decommissioning of the unit at the stage of designing a new plant
- the development and use of cleaner technologies
- where practicable, the application of sector benchmarking on a regular basis, including energy efficiency and energy saving, water efficiency and water saving, raw material use and choice of input materials, emissions to air, discharges to water, and generation of waste.

5.1.1.2 Housekeeping and maintenance

It is BAT to implement a housekeeping and maintenance programme, which will include training and the preventative actions workers need to take to minimise specific environmental risks, see Sections 4.1.1(c) and 4.1.1.1.

5.1.1.3 Minimising the effects of reworking

It is BAT to minimise the environmental impacts of reworking by management systems that require regular re-evaluation of process specifications and quality control jointly by the customer and the operator (see Section 4.1.2). This can be done by:

- ensuring specifications are:
 - correct and up to date
 - compatible with legislation
 - applicable
 - attainable
 - measurable appropriately to achieve customer's performance requirements
- both customer and operator discussing any changes proposed in each other's processes and systems prior to implementation
- training operators in the use of the system
- ensuring customers are aware of the limitations of the process and the attributes of the surface treatment achieved.

5.1.1.4 Benchmarking the installation

It is BAT to establish benchmarks (or reference values) that enable the installation's performance to be monitored on an ongoing basis and also against external benchmarks (see Section 4.1.3). Benchmarks for individual activities are given in this chapter where data exists. Essential areas for benchmarking are:

- energy usage
- water usage
- raw material usage.

Record and monitor usage of all utility inputs by type: electricity, gas, LPG and other fuels, and water, irrespective of source and cost per unit, see Sections 4.1.1(j) and 4.1.3. The detail and period of recording, whether hourly, by shift, by week, by square metre throughput or other measure etc. will be according to the size of the process and the relative importance of the measure.

It is BAT to continuously optimise the use of inputs (raw materials and utilities) against benchmarks. A system to action the data will include:

- identifying a person or persons responsible for evaluating and taking action on the data
- action being taken to inform those responsible for plant performance, including alerting operators, rapidly and effectively, to variations from normal performance
- other investigations to ascertain why performance has varied or is out of line with external benchmarks.

5.1.1.5 Process line optimisation and control

It is BAT to optimise individual activities and process lines by calculating the theoretical inputs and outputs for selected improvement options and comparing with those actually achieved see Section 4.1.4.

Information from benchmarking, industry data, advice in this document and other sources can be used. Calculations can be performed manually, although this is easier with software.

For automatic lines, it is BAT to use real time process control and optimisation, see Section 4.1.5.

5.1.2 Installation design, construction and operation

Process lines in this sector have commonality with the storage of chemicals, and the reference document on BAT for Storage contains relevant techniques [23, EIPPCB, 2002]. It is BAT to design, construct and operate an installation to prevent pollution by the identification of hazards and pathways, simple ranking of hazard potential and implementing a three-step plan of actions for pollution prevention (see Section 4.2.1):

Step 1:

- allow sufficient plant dimensions
- contain areas identified as being at risk from any chemical spillage by using appropriate materials to provide impervious barriers
- ensure the stability of the process lines and components (including temporary and infrequently used equipment).

Step 2:

- ensure storage tanks used for risk materials are protected by using construction techniques such as double skinned tanks or by situating them within contained areas
- ensure operating tanks in process lines are within a contained area
- where solutions are pumped between tanks, ensure the receiving tanks are of sufficient size for the quantity to be pumped
- ensure there is either a leak identification system or contained areas are regularly checked as part of the maintenance programme.

Step 3:

- regular inspection and test programmes
- emergency plans for potential accidents, which will include:
 - site major incident plans (appropriate to size and location of the site)
 - emergency procedures for chemical and oil spillages
 - containment facility inspections
 - waste management guidelines for dealing with waste arising from spillage control
 - identification of suitable equipment and regularly ensuring it is available and in good working order
 - ensure staff are environmentally aware and trained to deal with spillages and accidents
 - identification of the roles and responsibilities of persons involved.

5.1.2.1 Storage of chemicals and workpieces/substrates

In addition to the general issues in the reference document on Storage [23, EIPPCB, 2002], the following issues have been identified as specific BAT for this sector (see Section 4.2.2):

- avoid generating free cyanide gas by storing acids and cyanides separately
- store acids and alkalis separately
- reduce the risk of fires by storing flammable chemicals and oxidising agents separately
- reduce the risk of fire by storing any chemicals which are spontaneously combustible when damp, in dry conditions and separately to oxidising agents. Mark the storage area of these chemicals to avoid the use of water in fire-fighting
- avoid the contamination of soil and water environments from spillages and leakages of chemicals
- avoid or prevent the corrosion of storage vessels, pipework, delivery systems and control systems by corrosive chemicals and fumes from their handling.

To minimise additional processing, it is BAT to prevent degradation of metal workpieces/substrates in storage (see Section 4.3.1) by one or a combination of:

- shortening storage time
- controlling the corrosivity of the storage atmosphere by controlling the humidity, temperature and composition
- using either a corrosion preventing coating or corrosion preventing packaging.

5.1.3 Agitation of process solutions

It is BAT to agitate process solutions to ensure a movement of fresh solution over the work faces (see Section 4.3.4). This may be achieved by one or a combination of:

- hydraulic turbulence
- mechanical agitation of the workpieces
- low pressure air agitation systems in:
 - solutions where the air assists cooling by evaporation particularly when used with materials recovery (but see Section 5.1.4.3)
 - anodising
 - other processes requiring high turbulence to achieve high quality
 - solutions requiring oxidation of additives
 - where it is necessary to remove reactive gases (such as hydrogen).

It is not BAT to use low pressure air agitation with:

- heated solutions where the cooling effect from the evaporation increases the energy demand
- cyanide solutions as it increases carbonate formation
- solutions containing substances of concern where it increases the emissions to air (see Section 5.1.10).

It is not BAT to use high pressure air agitation because of the high energy consumption.

5.1.4 Utility inputs – energy and water

It is BAT to benchmark utilities (see Section 5.1.1.4). BAT for water usage materials efficiency are described in detail in Section 5.1.5 and 5.1.6.

5.1.4.1 Electricity – high voltage and large current demands

Measures to manage high voltages and high current demands are described in Section 4.4.1. It is BAT to reduce electricity consumption by:

- minimise reactive energy losses for all three phase supplies by testing at annual intervals to ensure that $\cos \varphi$ between the voltage and the current peaks lies permanently above 0.95
- reduce the voltage drop between conductors and connectors by minimising the distance between the rectifiers and anodes (and conductor rolls in coil coating). The installation of the rectifiers in direct proximity of the anodes is not always realisable or may subject the rectifiers to sever corrosion and/or maintenance. Alternatively, bus bars with larger cross-sectional area can be used
- keep the bus bars short, with sufficient cross-sectional area, and keep cool, using water cooling where air cooling is insufficient
- use individual anode feeding by bus bar with controls to optimise current setting
- regularly maintain rectifiers and contacts (bus bars) in the electrical system
- install modern electronically-controlled rectifiers with a better conversion factor than older types
- increase of conductivity of process solutions through additives and by maintenance of solutions (this must be in be optimised with Sections 5.1.5.3, 5.1.5.3.1 and 5.1.6.1)
- use modified wave forms (e.g. pulse, reverse) to improve metal deposits, where the technology exists.

5.1.4.2 Heating

Different heating techniques are described in Section 4.4.2.

When using electric immersion heaters or direct heating applied to a tank, it is BAT to prevent fires by monitoring the tank manually or automatically to ensure it does not dry out.

5.1.4.3 Reduction of heating losses

It is BAT to reduce heating losses by (see Section 4.4.3):

- seeking opportunities for heat recovery
- reducing the amount of air extracted across the heated solutions by one of the techniques described in Sections 4.4.3 and 4.18.3
- optimising the process solution composition and working temperature range. Monitor temperature of processes and control within these optimised process ranges, see Sections 4.1.1, 4.1.3 and 4.4.3.
- insulating heated solution tanks by one or more of the following techniques:
 - using double skinned tanks
 - using pre-insulated tanks
 - applying insulation
- insulating the surface of heated tanks by using floating insulation sections such as spheres or hexagonals. Exceptions are where:
 - workpieces on racks are small, light and may be displaced by the insulation
 - workpieces are sufficiently large to trap the insulation sections (such as vehicle bodies)
 - the insulation sections can mask or otherwise interfere with the treatment in the tank.

It is not BAT to use air agitation with heated process solutions where the evaporation caused increases the energy demand (see Section 5.1.3).

5.1.4.4 Cooling

Cooling is described in Section 4.4.4. It is BAT to:

- prevent over-cooling by optimising the process solution composition and working temperature range. Monitor temperature of processes and control within these optimised process ranges, see Sections 4.1.1 and 4.1.3
- use closed refrigerated cooling system, for new or replacement cooling systems
- remove excess energy from process solutions by evaporation (see Section 4.7.11.2) where:
 - there is a need to reduce the solution volume for make-up chemicals
 - evaporation can be combined with cascade and/or reduced water rinsing systems to minimise water and materials discharges from the process (see Sections 5.1.5.4 and 5.1.6).
- install an evaporator system in preference to a cooling system where the energy balance calculation shows a lower energy requirement for forced evaporation than for additional cooling and the solution chemistry is stable, (see Section 4.7.11.3).

It is BAT to design, locate and maintain open cooling systems to prevent the formation and transmission of legionella (see Section 4.4.4.1)

It is not BAT to use once-through water cooling systems except where local water resources allow or where the water can be re-used (see Section 4.4.4.1).

5.1.5 Waste minimisation of water and materials

In this sector, most raw material losses occur in waste waters, therefore the minimisation of losses of water and raw materials are considered together in the following sections.

5.1.5.1 Water minimisation in-process

It is BAT to minimise water usage by:

- monitoring all points of water and materials usage in an installation, record the information on a regular basis, according to the usage and the control information required (see Section 4.4.5.2). The information is used for benchmarking and the environmental management system, see Section 5.1.1.4.
- recovering water from rinsing solutions by one of the techniques described in Sections 4.4.5.1, 4.7.8, 4.7.12 and referred to in Section 4.10 and re-use in a process suitable for the quality of the water recovered (see Section 5.1.5.1)
- avoiding the need for rinsing between activities by using compatible chemicals in sequential activities (see Section 4.6.2).

5.1.5.2 Drag-in reduction

It is BAT for new lines or upgrades to reduce drag-in of surplus water from prior rinsing by using an eco rinse (or pre-dip) tank, see Section 4.5. Build-up of particulates can be controlled to the required quality level by filtering.

This also assists drag-out reduction, in conjunction with other drag-out and rinsing techniques, (see Section 4.7.4, 4.7.11, 4.7.12 and 5.1.5.3).

Eco-rinse (pre-dip) cannot be used:

- where problems are caused with subsequent processes (such as partial chemical pre-plating)
- in carousel, coil coating or reel-to-reel lines
- with etching or degreasing
- in nickel lines because of increased quality problems
- in anodising, as material is removed from the substrate (not added).

5.1.5.3 Drag-out reduction

It is BAT to use one or more of the techniques described in this section and Sections 5.2.2, 5.2.3 and 5.2.4 to minimise the drag-out of materials from a process solution (see Section 4.6).

The exceptions are:

- where this is not necessary because of the application of alternative BAT:
 - where sequential chemical systems are compatible (see Section 5.1.5.1)
 - after an eco-rinse (pre-dip, see Section 5.1.5.2)
- where the reaction at the surface requires stopping by rapid dilution during:
(These are the same exceptions to a reduction in the rinsing ratio given in Section 5.1.5.4)
 - hexavalent chromium passivation
 - etching, brightening and sealing of aluminium, magnesium and their alloys
 - zincate dipping
 - pickling
 - pre-dip when activating plastic
 - activating prior to chromium plating
 - colour lightening after alkali zinc
- for draining time, where a delay causes de-activation of, or damage to, the surface between treatments, such as between nickel plating followed by chromium plating.

5.1.5.3.1 Reduction of viscosity

It is BAT to reduce the viscosity by optimising the process solution properties (see Section 4.6.5):

- lowering the concentration of chemicals or using low-concentration processes
- adding wetting agents
- ensuring the process chemicals do not exceed the recommended values
- ensuring the temperature is optimised according to the process range and the conductivity required.

5.1.5.4 Rinsing

It is BAT to reduce water consumption by using multiple rinsing (see Section 4.7.10).

Eco-rinse (pre-dip, see Section 5.1.5.2) can be combined with other rinse stages to increase effectiveness of the multiple rinsing system, see Section 4.7.11.

The reference value for water discharged from the process line using a combination of BAT to minimise water usage is 3 – 20 l/m²/rinse stage. Rinse stages and the calculation are described in Section 4.1.3.1. The value may be calculated to relate to other throughput factors (such as weight of metal deposited, weight of substrate throughput, etc) at individual installations. Values towards the lower end of the range can be achieved by both new and existing plants using techniques described in Section 4.7 and 4.10.

Spray techniques (see Section 4.7.5) are important techniques to achieve the lower end of this range.

PCB installations are generally above this range and may be in the order of 20 - 25 l/m²/rinse stage or higher. However, reductions in volume may be limited by high quality requirements.

It is BAT to conserve process materials by returning the rinse-water from the first rinse to the process solution (see Section 5.1.6.3, as well as Section 5.1.6.1).

Reductions in water discharge to the lower ends of these ranges may be limited for local environmental reasons by concentrations of:

- boron
- fluoride
- sulphate
- chloride.

The cross-media effects of increased energy and chemicals used to treat these substances outweigh the benefits of decreasing the water discharge to the lower part of the range.

The exceptions to this BAT to reduce water consumption are:

- where the reaction at the surface requires stopping by rapid dilution:
 - hexavalent chromium passivation
 - etching, brightening and sealing of aluminium, magnesium and their alloys
 - zincate dipping
 - pickling
 - pre-dip when activating plastic
 - activating prior to chromium plating
 - colour lightening baths after alkali zinc
- where there is a loss in quality caused by too much rinsing (Note: this exclusion is not applicable to Section 5.1.5.3).

5.1.6 Materials recovery and waste management

BAT is:

- prevention
- reduction
- re-use, recycling and recovery.

Of these, the prevention and reduction of all material losses is the priority. The loss of both metals and non-metallic components together can be prevented or significantly reduced by using BAT in the production processes (see the sections below and Sections 4.6 4.7, 4.7.8, 4.7.10, 4.7.11 and 4.7.12).

Metals in the sludge may be recovered off-site, see Section

The TWG considered the material efficiencies given in Section 3.2.3, and derived levels given in Table 5.1 for some processes that are associated with a variety of techniques referred to in this Section 5.1.6.

Process	Materials use efficiency in process %
Zinc plating	70 % with passivation (all processes) 80 % without (all processes)
	95 % for coil coating
Electrolytic nickel plating (closed loop)	95 %
Electrolytic nickel plating (not closed loop)	80 – 85 %
copper plating (cyanide process)	95 %
Copper plating (not closed loop)	95 %
Hexavalent chromium plating (closed loop)	95 %
Hexavalent chromium plating (not closed loop)	80 – 90 %
Precious metal plating	98 %
Cadmium	99 %

Table 5.1: Levels for in-process materials efficiency

5.1.6.1 Prevention and reduction

It is BAT to prevent the loss of metals and other raw materials together, as both metal and non-metallic components are retained. This is achieved by reducing and managing drag-out, described in Sections 4.6 and 5.1.5.3 and increasing drag-out recovery, as described in Section 4.7, 4.7.11 and referred to in Section 4.10, including ion exchange, membrane, evaporation and other techniques to both concentrate and re-use drag out and recycle rinse-waters.

It is BAT to prevent the loss of materials through overdosing. This is achieved by:

- monitoring the concentration of process chemicals
- recording and benchmarking usage (see Section 5.1.1.4)
- reporting deviations from benchmarks to the responsible person and making adjustments as required to keep the solution within optimum limit values.

This is most consistently achieved by using analytical control (usually as Statistical Process Control, SPC) and automated dosing (see Section 4.8.1).

5.1.6.2 Re-use

It is BAT to recover the metal as anode material using the techniques described in Section 4.12 and in combination with drag-out recovery (Section 4.7 and Sections 5.1.6.4 and 5.1.6.3). This can greatly assist with reducing water usage and recovery of water for further rinse stages.

5.1.6.3 Materials recovery and closing the loop

It is BAT to conserve process materials by returning the rinse-water from the first rinse to the process solution. This can be achieved by a combination of the techniques described in Sections 4.7, 4.7.8, 4.7.10, 4.7.11 and 4.7.12). Solution maintenance may be increased, although most modern systems require increased maintenance (often online). Suitable methods for controlling metals build up are discussed in Section 5.1.6.5, and other maintenance methods are given in Section 5.1.7.

Where all the materials are returned with the rinse-water, a closed loop is achieved for this process within the process line (see Section 4.7.11). Closing the loop refers to one process chemistry within a process line, not to entire lines or installations.

It is BAT to close the materials loop for:

- hexavalent hard chromium
- cadmium.

Closing the loop for process chemicals can be achieved by applying a suitable combination of techniques such as: cascade rinsing, ion exchange, membrane techniques, evaporation (see Section 4.7.11)

Closed loop is not zero discharge: there may be small discharges from the treatment processes applied to the process solution and process water circuits (such as from ion exchange regeneration). It may not be possible to keep the loop closed during maintenance periods. Wastes and exhaust gases/vapours will also be produced. There may also be discharges from other parts of the process line.

Closing the loop achieves a high raw material utilisation rate and in particular can:

- reduce the use (and therefore cost) of raw materials and water
- as a point-source treatment technique, achieve low emission limit values
- reduce the need for end-of-pipe waste water treatment (e.g. removing nickel from contact with effluent containing cyanide)
- reduce overall energy usage when used in conjunction with evaporation to replace cooling systems
- reduce the use of chemicals for treating the recovered materials that would otherwise be discharged in the waste water
- reduce the loss of conservative materials such as PFOS where used.

Closing the loop has been successfully achieved on some substrates for:

- precious metals
- cadmium
- barrel nickel plating
- copper, nickel and hexavalent chromium for decorative rack plating
- hexavalent decorative chromium
- hexavalent hard chromium
- etching copper from PCBs.

Details are given in Section 4.7.11; for nickel (using reverse osmosis) see Section 4.7.11.5; and for chromium (using evaporation) see Section 4.7.11.6.

5.1.6.4 Recycling and recovery

After applying techniques for the prevention and reduction of losses (see Section 5.1.6.4 above), it is BAT to (see Section 4.17.3):

- identify and segregate wastes and waste waters either at the process stage or during waste water treatment to facilitate the recovery or re-use
- recover and/or recycle metals from waste waters as described in Section 4.12 and 4.15.7
- re-use materials externally, where the quality and quantity produced allow, such as using aluminium hydroxide suspension from aluminium surface treatments to precipitate phosphate from the final effluents at municipal waste water treatment plants
- recover materials externally, such as phosphoric and chromic acids, spent etching solutions, etc.
- recover metals externally.

The overall efficiency can be raised by external recycling. However, third party routes have not been validated by the TWG for their cross-media impacts or their own recovery efficiency.

5.1.6.5 Other techniques to optimise raw material usage

Different electrode yields

In electroplating, where the anode efficiency is higher than the cathode efficiency and the metal concentration is constantly increasing, it is BAT to control the metal concentration according to the electrochemistry (see Section 4.8.2) by:

- external dissolution of the metal, with electroplating using inert anodes. Currently, the main application is for alkaline cyanide-free zinc plating
- replacing some of the soluble anodes by membrane anodes with separate extra current circuit and control. Membrane anodes are breakable, and it may not be possible to use this technique in sub-contract plating, where the shapes and sizes of parts to be plated vary continuously (and may make contact with and break membranes)
- using of insoluble anodes where the technique is proven.

5.1.7 General process solution maintenance

It is BAT to increase the process bath life as well as maintain output quality, particularly when operating systems near to, or at, the closing of the materials loop (see Section 5.1.6.3) by:

- determining critical control parameters
- maintaining them within established acceptable limits by the removal of contaminants.

Suitable processes are described in Sections 4.10 and 4.11.

5.1.8 Waste water emissions

An overview of techniques is discussed in Section 4.16. Specific BAT for waste water treatment and discharges are given below.

5.1.8.1 Minimisation of flows and materials to be treated

It is BAT to minimise all water usage in all processes, however, there are local situations where the reduction of water usage may be limited by increasing concentration(s) of anions that are difficult to treat, see Section 5.1.5.

It is BAT to eliminate or minimise the use and loss of materials, particularly priority substances, see Sections 4.6 and 4.7 (see also water and raw materials usage techniques to close the materials loop, Section 5.1.6.3). Substitutes for and/or control of certain hazardous substances is described in Section 5.2.5.

5.1.8.2 Testing, identification and separation of problematic flows

It is BAT when changing types or sources of chemical solutions and prior to their use in production to test for their impact on the existing (in-house) waste water treatment systems (as described in Section 4.16.1). If the test indicates a potential problem either:

- reject the solution, or
- change the waste water treatment system to deal with the problem.

It is BAT to identify, separate and treat flows that are known to be problematic when combined with other flows (see Section 4.16.1 and 4.16.2) such as:

- oils and greases (see Section 4.16.3)
- cyanide (see Section 4.16.4)
- nitrite (see Section 4.16.5)
- chromates (CrVI) (see Section 4.16.6)
- complexing agents (Section 4.16.8)
- cadmium (Note: while it is a Parcom Recommendation [12, PARCOM, 1992] to separate cadmium flows for treatment, it is BAT to operate cadmium processes in a closed loop, with no discharge to water, see Section 5.1.6.3).

5.1.8.3 Discharging waste water

It is BAT to monitor and discharge waste water according to Section 4.16.13.

The emission levels given in are Table 5.2 achieved in a sample of surface treatment installations. They are derived from Section 3.3.1 and from Table 3.20 and are indicative of what can be achieved using a combination of BAT using a combination of in-process techniques described in Sections 4.5 to 4.12 and Section 4.16 as well as in the BREF on waste water and waste gas treatment/management [87, EIPPCB,]. BAT for substituting less hazardous substances and processes are given in Section 5.2.5 and discussed in Section 4.9.

For a specific installation, these concentration levels should be considered in conjunction with the loads emitted from the installation, the installation's technical specification, e.g. throughput, as well as other BAT, especially measures to reduce water consumption. In particular, it should be noted that measures to reduce the flow can reduce load, until a point where increased concentration of dissolved salts increases the solubility of some metals, such as zinc (see Sections 3.3.1 and 5.1.5.1).

In Section 3.3.1 it can be seen that, while the low ends of these ranges may be regularly met in some installations, they may not be met with 100 % confidence for 100 % of normal operation.

BAT may be optimised for one parameter, but this may not be optimal for other parameters (for example, flocculation and settlement of metals in waste water treatment cannot be optimised for individual metals). This means that the lowest values in the ranges may not be all be met at the same time. In site-specific or substance-specific cases, separate treatment(s) may be required.

The BAT associated with emission values are expected for samples that are daily composites.

Note that only relevant substances (i.e. those used and arising in the processes in the installation) apply to the individual installations.

Emission levels associated with some plants using a range of BAT				
These values are for daily composites unfiltered prior to analysis and taken after treatment and before any kind of dilution, such as by cooling water, other process waters or receiving waters				
All values are mg/l	Jig, barrel, small scale coil, automotive, PCB and other activities not large scale steel coil		Large scale steel coil coating	
	Discharges to public sewer (PS) or surface water (SW)	Additional determinands only applicable for surface water (SW) discharges	Tin or ECCS	Zn or Zn-Ni
Ag	0.1 – 0.5			
Al		1 – 10		
Cd	0.1 – 0.2			
CN free	0.01 – 0.2			
Cr(VI)	0.1 – 0.2		0.0001 – 0.01	
Cr total	0.1 – 2.0		0.03 – 1.0	
Cu	0.2 – 2.0			
F		10 – 20		
Fe		0.1 - 5	2 - 10	
Ni	0.2 - 2.0			
Phosphate as P		0.5 - 10		
Pb	0.05 - 0.5			
Sn	0.2 - 2		0.03 - 1.0	
Zn	0.2 - 2.0		0.02 - 0.2	0.2 - 2.2
COD		100 - 500	120 - 200	
HC Total		1 - 5		
VOX		0.1 - 0.5		
Suspended Solids		5 - 30	4 - 40 (surface waters only)	

Table 5.2: Emission ranges to water associated with some BAT for some installations

5.1.8.4 Zero discharge techniques

Zero discharge can be achieved for a whole installation, based on a mixture of techniques and discussed in Section 4.16.12.

Zero discharge is not BAT, as it generally involves high power consumption and can produce wastes that are difficult to dispose of. The combination of techniques required to achieve zero discharge are also high in capital and running costs. They are used in isolated cases for specific reasons.

5.1.9 Waste

BAT for waste minimisation are given in Section 5.1.5 and for materials recovery and waste management in Section 5.1.6.

5.1.10 Air emissions

For VOC releases from the vapour degreasing equipment, e.g. trichloroethylene and methylene chloride, refer to the reference documents on surface treatment using solvents [90, EIPPCB,] and waste water and waste gas management/treatment in the chemical sector [87, EIPPCB,] as well as the Solvent Emissions Directive [97, EC, 1999]

Table 5.3 lists substances and/or activities whose fugitive emissions may have local environmental impacts and the conditions when they need air extraction. In some cases, this is related to health and safety inside the workplace.

Other processes may also require extraction, and individual process descriptions are given in Chapters 2 and 4

When extraction is applied, it is BAT use the techniques described in Section 4.18.3 to minimise the amount of air to be discharged.

Type of solution or activity	Solutions needing extraction	
In all cases:		
Cyanide		
Cadmium		
Hexavalent chromium with one or more of following attributes:	<ul style="list-style-type: none"> • electroplating solutions • heated or self-heating • agitated with air 	
Nickel solutions	When agitated with air	
Ammonia	Solutions emitting ammonia, either where ammonia is a component or a breakdown product	
Dust producing activities such as polishing and finishing		
Using insoluble anodes	All: hydrogen and/or oxygen are formed with a risk of deflagration.	
Acid solutions		
	Solutions not needing extraction	Solutions needing extraction
Nitric acid processes with emissions of NO _x		<p>Processes for the surface treatment of metal which are likely to result in the release into the air of any acid-forming oxide of nitrogen include:</p> <ul style="list-style-type: none"> • chemical brightening of aluminium • bright dipping of chemical polishing of copper alloys • pickling using nitric acid, which may also contain hydrofluoric acid • in-situ cleaning using nitric acid • chemical stripping using nitric acid
Pickling and stripping using hydrochloric acid	Hydrochloric acid used at ambient temperatures and concentrations below 50 % v/v technical grade with water generally does not evolve HCl gas or fumes which require extraction for health and safety reasons	Hydrochloric acid used at higher concentrations and/or at elevated temperatures generates significant releases of HCl gas or fumes which requires extraction for health and safety reasons and to prevent corrosion in the workplace. (Technical grade is 31 - 36 % HCl, therefore 50 % dilution equals a solution of about 15 - 18 % HCl. Solutions stronger than this require extraction).
Pickling and stripping using sulphuric acid	Sulphuric acid used at temperatures below 60 °C generally does not evolve acid mists which require extraction for health and safety reasons	Sulphuric acid used at temperatures above 60 °C releases a fine aerosol of the acid which requires extraction for health and safety reasons and to prevent corrosion in the workplace
Hydrofluoric acid pickling		In all cases
Alkali solutions		
Aqueous alkaline cleaning	Alkaline cleaning chemicals are non-volatile and do not require fume extraction for health and safety reasons or local environmental protection	Alkaline cleaning tanks operating above 60 °C can generate significant amounts of water vapour which may be extracted for operator comfort and to prevent corrosion

Table 5.3: Solutions and activities which may require prevention of fugitive emissions

The emission levels given in Table 5.4 are achieved in a sample of surface treatment installations. They are derived in Section 3.3.3 and from Table 3.28 and are indicative of what can be achieved using a combination of in-process techniques described in Section 4.18 and in the BREF on waste water and waste gas treatment/management [87, EIPPCB,]. BAT for substituting less hazardous substances and processes are given in Section 5.2.5 and discussed in Section 4.9.

Emissions mg/Nm ³	Emission ranges for some installations mg/Nm ³	Emission ranges for some large scale steel coil activities mg/Nm ³	Some techniques used to meet local environmental requirements associated with the emission ranges
Oxides of nitrogen (total acid forming as NO₂)	<5 – 500	nd	Scrubbers or adsorption towers generally give values below about 200 mg/l and lower with alkali scrubbers
Hydrogen fluoride	<0.1 – 2	nd	Alkali scrubber
Hydrogen chloride	<0.3 – 30	Tin or chromium (ECCS) process 25 – 30	Water scrubber <i>See Note 2</i>
SO_x as SO₂	1.0 – 10	nd	Countercurrent packed tower with final alkaline scrubber
Ammonia as N - NH₃	0.1 – 10 Note: Data is from electroless nickel. No data for PCB manufacture	nd	Wet scrubber
Hydrogen cyanide	0.1 – 3.0	nd	Non-air agitation Low temperature processes Non-cyanide processes The lower end of the range can be met by using an alkali scrubber
Zinc	<0.01 – 0.5	Zinc or zinc nickel process 0.2 – 2.5	Water scrubber <i>See Note 2</i>
Copper	<0.01 – 0.02	nd	<i>See Note 2</i>
CrVI and compounds as chromium	Cr(VI) <0.01 – 0.2 Total Cr <0.1 – 0.2	nd	Substitution of Cr(VI) by Cr(III) or non-chromium techniques (see Section 5.2.5.7) Droplet separator Scrubbers or adsorption tower
Ni and its compounds as nickel	<0.01 – 0.1	nd	Condensation in heat exchanger Water or alkali scrubber Filter <i>See Note 2</i>
Particulate matter	<5 – 30	Tin or chromium (ECCS) process 1 – 20	For dry particulates treatment may be necessary to achieve the lower end of the range, such as: Wet scrubber Cyclone Filter For wet processes, wet or alkali scrubbers achieve the lower end of the range <i>See Note 2</i>
<i>Note 1: nd = no data provided</i>			
<i>Note 2: in some circumstances, some operators are meeting these ranges without EoP</i>			

Table 5.4: Indicative emission ranges to air achieved by some installations

5.1.11 Noise

It is BAT to identify significant noise sources and potential targets in the local community. It is BAT to reduce noise where impacts will be significant by using appropriate control measures (see Section 4.19), such as:

- effective plant operation, for example:
 - closure of bay doors
 - minimising deliveries and adjusting delivery times, see Section 4.18
- engineered controls such as installation of silencers to large fans, use of acoustic enclosures where practicable for equipment with high or tonal noise levels, etc.

5.1.12 Groundwater protection and site decommissioning

It is BAT to protect groundwater and assist the decommissioning of the site by:

- giving consideration to the eventual decommissioning during the design or upgrading of the installation, see 4.1.1(h).
- situating the materials on site within contained areas, using the design operation and accident prevention and handling techniques described in Section 5.1.2
- recording the history (as far as known) of priority and hazardous chemicals in the installation, and where they were used and stored (see Section 4.1.1.1).
- update this information yearly, in line with the EMS (see Section 4.1.1)
- use the information acquired to assist with installation shutdown, removal of equipment, buildings and residues from the sites, see 4.1.1(h).
- take remedial action for potential contamination of groundwater or soil (see Section 4.1.1).

5.2 BAT for specific processes

The general BAT in Section 5.1 apply to jig, barrel and manual lines. The following specific BAT also apply.

5.2.1 Jigging

In jig (rack) lines, it is BAT to arrange the jigging to minimise loss of workpieces and maximise current carrying efficiency, see Section 4.3.3.

5.2.2 Jig lines – drag-out reduction

It is BAT to prevent drag-out of process solutions in jig processing lines by a combination of the following techniques (see Section 4.6.3 and individual references):

- arrange the workpieces to avoid retention of process liquids by jiggling at an angle and jiggling cup-shaped components upside down
- maximise draining time when withdrawing the jigs. Indicative reference values for draining jigs are given in Table 4.2. This will be limited by:
 - the type of process solution
 - the quality required (long draining times can result in the process solution part-drying on the substrate)
 - the transporter duty time available for automatic plants
- regularly inspect and maintain jigs so there are no fissures or cracks to retain process solution, and that the jig coatings retain their hydrophobic properties
- arrange with customers to manufacture components with minimal spaces to trap process solution or to provide drainage holes
- fit drainage ledges between tanks canted back to the process tank.
- spray-rinse, mist or air spray excess process solution back into the process tank (see Sections 4.6.6 and 4.7.5). This may be limited by:
 - the type of process solution
 - the quality required.

Spraying can give rise to over-spray, aerosols of chemicals, and drying too rapidly causing blemishes. These can be overcome by:

- spraying in a tank or other enclosure
- using low-pressure sprays (splash rinsing).

There is a possibility that legionella bacteria may infect aerosols. However, these can be controlled by design and maintenance.

5.2.3 Barrel lines – drag-out reduction

It is BAT to prevent drag-out of process solutions in barrel processing lines by a combination of the following techniques (see Section 4.6.4):

- constructing the barrels from a smooth hydrophobic plastic and inspecting regularly for worn areas, damage, recesses or bulges that may retain process solution
- ensuring the bores of holes in the barrel bodies have sufficient cross-sectional area in relation to the required thickness of the panels to minimise capillary effects
- ensuring the proportion of holes in the barrel bodies is high as possible for drainage while retaining mechanical strength
- replacing holes with mesh plugs (although this may not be possible with heavy workpieces).

On withdrawing the barrel, it is BAT to prevent drag-out of process solutions in barrel processing lines:

- withdrawing slowly to maximise drag-out, see Table 4.3
- rotating intermittently
- sparging (rinsing using a pipe inside the barrel)
- fitting drainage ledges between tanks canted back to the process tank
- inclining the barrel from one end where possible.

Indicative values for draining barrels are given in Table 4.3.

It should be noted that while these techniques reduce the drag-out in barrel lines, recovery of the subsequent first rinse is more effective (see Sections 5.1.5 and 5.1.6).

5.2.4 Manual lines

It is BAT when operating manual lines to:

- apply the jiggling techniques in Sections 4.3.3 when jig processing
- increase drag-out recovery rate by using the techniques described in Sections 5.1.5, 5.1.6, as well as techniques in Sections 5.2.2 and 5.2.3
- support the jig or barrel on racks above each activity to ensure the correct draining time and increase the efficiency of spray rinsing, see Sections 4.7.6 and 5.1.5.4.

5.2.5 Substitution for, and/or control of, hazardous substances

It is a general BAT to use less hazardous substances (see Section 4.9).

Specific cases where less hazardous substances and/or processes can be used are given below. Where a hazardous substance has to be used, techniques for minimising the use of the hazardous substance and/or reducing its emission are described below. In some cases, this is in conjunction with improving process efficiency and/or minimising the use or emission of materials in activities.

5.2.5.1 EDTA

It is BAT to avoid the use of EDTA and other strong chelating agents by one of the following:

- using biodegradable substitutes such as those based on gluconic acid (see Section 4.9.1)
- using alternative methods such as direct plating in PCB manufacture (see Section 4.15)

Where EDTA is used it is BAT to:

- minimise its release using material and water saving techniques (See Section 5.1.5 and 5.1.6)
- ensure no EDTA is released to waste water by using treatment techniques described in Section 4.16.8.

Cyanide is a strong chelating agent, but is discussed separately in Section 5.2.5.3.

5.2.5.2 PFOS (perfluorooctane sulphonate)

There are limited options to substitute for PFOS and health and safety may be a particularly important factor.

Where PFOS is used, it is BAT to minimise the use by:

- monitoring and controlling the additions of materials containing PFOS by measuring surface tension (see Section 4.9.2)
- minimising air emissions by using floating insulation sections (see Section 4.4.3)
- controlling the air emissions of the hazardous fumes as described in Section 4.18.

Where PFOS is used, it is BAT to minimise its emission to the environment by material conservation techniques, such as closing the material loop, see Section 5.1.6.3.

In anodising plants, it is BAT to use PFOS-free surfactants, see Section 4.9.2

In other processes, it is BAT to seek to phase out PFOS. The are limitations to these options discussed in the indicated sections:

- using PFOS-free processes: substitutes for alkali cyanide-free zinc electroplating Sections 4.9.4.2 and for hexavalent chromium processes, see Section 4.9.6
- enclosing the process or the relevant tank for automatic lines, see Sections 4.2.3 and 4.18.2.

5.2.5.3 Cyanide

It is not possible to replace cyanide in all applications, see Table 4.9. Where cyanide solutions have to be used, it is BAT to use closed loop technology with the cyanide processes 5.1.6.3.

However, cyanide degreasing is not BAT (see Sections 4.9.5 and 4.9.14).

When cyanide process solutions need to be agitated it is not BAT to use low pressure agitation as it increases carbonate formation (see Section 5.1.3)

5.2.5.4 Zinc cyanide

It is BAT to substitute zinc cyanide solutions by using (see Section 4.9.4):

- acid zinc for optimum energy efficiency, reduced environmental emissions and for bright decorative finishes (see Section 4.9.4.3)
- alkali cyanide-free zinc where metal distribution is important (see Section 4.9.4.2, but note it may contain PFOS, see Section 5.2.5.2)

5.2.5.5 Copper cyanide

It is BAT to substitute cyanide copper by acid or pyrophosphate copper (see Section 4.9.5), except:

- for strike plating on steel, zinc die casts, aluminium and aluminium alloys
- where copper strike plating on steel or other surfaces would be followed by copper plating.

5.2.5.6 Cadmium

It is BAT to plate cadmium in a closed loop system, see Section 5.1.6.3.

It is BAT to carry out cadmium plating in separately contained areas, with a separately monitored emission level to water.

5.2.5.7 Hexavalent chromium

Substitution for hexavalent chromium is discussed in Section 4.9.8 and in more detail in Annex 8.10: BAT are described in the sections below. There are general limitations to substitution: trivalent chromium has not been used on an economic scale on large scale steel coating and cannot be used for hard chromium applications. Chromic acid anodising has limited use, mainly for aerospace, electronics and other specialist applications. There is no replacement.

5.2.5.7.1 Decorative chromium plating

For decorative uses, it is BAT to replace hexavalent chromium either:

- by plating with trivalent chromium. Where increased corrosion resistance is required, this can be achieved by trivalent chromium solution with increased nickel layer underneath and/or organic passivation (for Cr(III) chloride based solutions, see Section 4.9.8.3, and for Cr(III) sulphate based solutions, 4.9.8.4).

Or:

- with a chromium-free technique, such as tin-cobalt alloy, where specifications allow (see Section 4.9.9)

However, there may be reasons at the installation level where hexavalent chromium is used for decorative finishes, such as where customer specifications require it for:

- colour
- high corrosion resistance
- hardness or wear resistance.

It is not BAT to use trivalent chromium for plating large scale steel coil as it is not technically proven. The electrolyte composition is likely to reduce plating efficiency below that sufficient for the line speed.

Plating systems such as for hexavalent chromium are a significant investment and include specific equipment such as anodes, as well as the solutions. The solution cannot simply be changed for different customer batches. However, to minimise the amounts of hexavalent chromium, it is possible to use a cold chromium technique (see Section 4.9.8.2) and where there is more than one decorative hexavalent chromium process line in the same installation, the option exists to run one or more one lines for hexavalent specifications and one or more lines with trivalent chromium

When changing to trivalent or other solutions, it is BAT to check for complexing agents interfering with waste water treatment, see Section 5.1.8.2.

5.2.5.7.2 Hexavalent chromium plating

When using hexavalent chromium plating, it is BAT to:

- reduce air emissions by one or a combination of the following (see Section 4.18):
 - covering the plating solution during plating, either mechanically or manually, particularly when plating times are long or during non-operational periods
 - use air extraction with condensation of the mists in the evaporator for the closed loop materials recovery system. Substances which interfere with the plating process may need to be removed from the condensates before re-using, or removed during bath maintenance (see Section 4.7.11.6)
 - for new lines or when rebuilding the process line and where the workpieces have sufficient uniformity of size, enclose the plating line or plating tank (see Section 4.2)
- operate hexavalent chromium solutions on a closed loop basis (see Sections 4.7.11.6 and Section 5.1.6.3 above). This retains PFOS and Cr(VI) in the process solution.

5.2.5.7.3 Chromium conversion (passivation) coatings

Reductions in the use of Cr(VI) passivations are being driven by the End of Life Vehicles and RoHS directives [98, EC, 2003, 99, EC, 2000]. However, at the time of preparing this BREF (2004), the TWG reports that current alternatives are new and no BAT can be concluded. Trivalent passivations can be used, but have up to ten times the chromium concentration as well as requiring higher energy input. They cannot match the higher corrosion resistance of the brown, olive drab or black passivations achieved with Cr(VI) systems without using additional coatings. Insufficient data has been supplied on non-chromium systems and they may contain substances that are hazardous to the environment.

5.2.5.7.4 Phospho-chromate finishes

It is BAT to replace hexavalent chromium with non-hexavalent chromium systems, see Section 4.9.12.

5.2.6 Substitution for polishing and buffing

It is BAT to use acid copper to replace mechanical polishing and buffing. However, this is not always technically possible. The increased cost may be offset by the need for dust and noise reduction techniques, see Section 4.9.13.

5.2.7 Substitution and choices for degreasing

Surface treatment operators, particularly contract or jobbing shops, are not always well informed by their customers of the type of oil or grease on the surface of the workpieces or substrates. It is BAT to liaise with the customer or operator of the previous process (see to Section 4.3.2) to:

- minimise the amount of oil or grease
and/or
- select oils, greases or systems that allow the use of the most environmentally friendly-degreasing systems.

It is BAT where there is excessive oil, to use physical methods to remove the oil, such as centrifuge (Section 4.9.14.1) or air knife (Section 4.9.15). Alternatively, for large, quality-critical and/or high-value parts, hand wiping can be used (see Section 4.9.15).

5.2.7.1 Cyanide degreasing

It is BAT to replace cyanide degreasing with other technique(s), see Sections 5.2.5.3 and 4.9.5.

5.2.7.2 Solvent degreasing

Solvent degreasing can be replaced by other techniques (see Section 4.9.14 and specifically 4.9.14.2) in all cases in this sector as subsequent treatments are water-based and there are no incompatibility issues. There may be local reasons at an installation level for using solvent-based systems, such as where:

- a water-based system can damage the surface being treated
- there a specific customer has a specific quality requirement.

5.2.7.3 Aqueous degreasing

BAT is to reduce the use of chemicals and energy in aqueous degreasing systems by using long-life systems with solution regeneration and/or continuous maintenance, off-line or on-line (see Sections 4.9.14.4, 4.9.14.5, and 4.11.13).

5.2.7.4 High performance degreasing

For high performance cleaning and degreasing requirements, it is BAT to either use a combination of techniques (see Section 4.9.14.9), or specialist techniques such as dry ice or ultrasonic cleaning (see Sections 4.9.14.6 and 4.9.14.7).

5.2.8 Maintenance of degreasing solutions

To reduce materials usage and energy consumption, it is BAT to use one or a combination of the techniques for maintenance and extending the life of degreasing solutions. Suitable techniques are given in Section 4.11.13.

5.2.9 Pickling and other strong acid solutions – techniques for extending the life of solutions and recovery

Where consumption of acid for pickling is high, it is BAT to extend the life of the acid by using one of the techniques in Section 4.11.14, or extend the life of electrolytic pickling acids by using electrolysis to remove by-metals and oxidise some organic compounds (see Section 4.11.8).

Pickling and other strong acids may also be recovered or re-used externally, see Section 4.17.3 and 5.1.6.4, but may not be BAT in all cases.

5.2.10 Recovery of hexavalent chromating solutions

It is only BAT to recover hexavalent chromium in concentrated and expensive solutions such as black chromating solutions containing silver. Suitable techniques such as ion exchange or membrane electrolysis techniques used at the normal scale for the sector are referenced in Sections 4.10, 4.11.10 and 4.11.11. For other solutions, the make up costs for new chemicals are only EUR 3 - 4/l.

5.2.11 Anodising

In addition to the generic BAT, any relevant specific BAT for processes and chemicals (described above) apply to anodising. In addition, the following BAT apply specifically to anodising:

- heat recovery: It is BAT to recover the heat from anodising sealing baths using one of the techniques described in Section 4.4.3.
- recovery of caustic etch: It is BAT to recover caustic etch (see Section 4.11.5) if:
 - there is a high consumption of caustic solution
 - there is no use of any additive to inhibit the precipitation of the alumina
 - the etched surface achieved meets specifications.
- closed loop rinsing: It is not BAT for anodising to use a closed rinsed water cycle with ion exchange, as the chemicals removed are of similar environmental impact and quantity to the chemicals required for regeneration
- use PFOS-free surfactants (see Section 5.2.5.2).

5.2.12 Continuous coil – large scale steel coil

In addition to the generic BAT described in Section 5.1, any relevant BAT for processes and chemicals (described above in Sections 5.1 and 5.2) apply to large scale steel coil coating. The following BAT apply specifically to coil processing:

- use real time process control to ensure constant process optimisation (see Section 4.1.5)
- use energy efficient motors when replacing motors or for new equipment, lines or installations (see Section 4.4.1.3)
- use squeeze rollers to prevent drag-out from process solutions or prevent the dilution of process solutions by drag-in of rinse-water (see Section 4.6 and 4.14.5)
- switch the polarity of the electrodes in electrolytic degreasing and electrolytic pickling processes at regular intervals (see Section 4.8.3)
- minimise the use of oil by using a covered electrostatic oiler (see Section 4.14.16)
- optimise the anode-cathode gap for electrolytic processes (see Section 4.14.12)
- optimise conductor roll performance by polishing (see Section 4.14.13)
- use edge polishers to remove metal build-up formed at the edge of the strip. (see Section 4.14.14)
- use edge masks to prevent overthrow when plating one side only (see Section 4.14.15).

5.2.13 Printed circuit boards (PCBs)

In addition to the general BAT described in Section 5.1, any relevant BAT for processes and chemicals (described above in Sections 5.2 and 5.3) apply to printed circuit board production. The following BAT apply specifically to PCB manufacture:

- rinsing: When rinsing between steps, use squeeze (wiper) rollers to reduce drag-out, sprays and multiple rinse techniques described for other processes in Sections 4.6, 4.7 and particularly 4.7.5)
- manufacturing the inner layers: This area is changing rapidly, with technological advances driving customer specifications. Use techniques with low environmental impact, such as alternative techniques to oxide bonding, see Section 4.15.1
- dry resists: When developing dry resist (see Section 4.15.5):
 - reduce drag-out by rinsing with fresh developer solution
 - optimise the spraying of developer
 - control the concentrations of the developer solution
 - separate the developed resist from the effluent, such as by ultrafiltration
- etching, in general: Use the drag-out and multiple rinse techniques described in Sections 4.6 and 4.7.10. Feed back the first rinse into the etching solution
- acid etching: Monitor the concentration of acid and hydrogen peroxide regularly and maintain an optimum concentration (see Section 4.15.6)
- alkali etching: Monitor the level of etchant and copper regularly and maintain an optimum concentration. For ammonia etching, regenerate the etching solution and recover the copper as described (see Section 4.15.7)
- resist stripping: Separate the resist from the effluent by filtration, centrifuge or ultrafiltration according to the size of the flow (see Section 4.15.8)
- stripping of the etch (tin) resist: Collect rinsing waters and concentrate separately. Precipitate the tin-rich sludge and send for external recovery (see Section 4.15.9)
- disposal of spent solutions: Many solutions contain complexing agents, such as those used for:
 - immersion or direct plating
 - black or brown oxide process for inner layers

It is BAT to assess and dispose of them according to Section 4.15.10

- to reduce air emissions from the application of solder mask: use high solids, low VOC resins (see Section 4.15.11).

6 EMERGING TECHNIQUES FOR THE SURFACE TREATMENT OF METALS AND PLASTICS

An emerging technique is understood in this document as a novel technique that has not yet been applied in any industrial sector on a commercial basis. This chapter contains those techniques that may appear in the near future and that may be applicable to the surface treatment of metals and plastics by electrolytic or chemical processes.

6.1 Process-integrated automated plating

Description

A project was initiated to integrate the electroplating processes into the production line to minimise the process costs and environmental impacts (it is referred to as FIO in German).

The technology is particularly suited to uniform cylindrical workpieces manufactured in large numbers. The anode is then shaped to fit around the workpiece (the cathode), leaving a very small space between the cathode and the anode and creating an extremely high field intensity. During plating, the anode is spun rapidly, which creates turbulence in the electrolyte, preventing ion transport in the diffusion layer which is the limiting factor.

The combination of these two factors allows the electroplating to proceed rapidly, permitting the process to be integrated into a production line.

An automatic sealed system delivers the electrolyte and removes it when it becomes exhausted. A separate central processing system for returned electrolytes keeps the production line waste and waste water free. Automation of the process means that staff are not exposed to any chemicals.

Achieved environmental benefits

Waste- and waste water-free plating on the process line.

Deletion of production steps with a pollution load, such as degreasing and pickling.

Cross-media effects

No data provided

Applicability

Close co-operation (interdependence) between the operators and the chemical suppliers.

The process requires the use of proprietary chemicals and all the used chemicals must be returned to the supplier.

Driving force for implementation

Workpieces have to be taken from the production line to the plating line for coating, then returned for further processing or assembly. This creates additional work, as well increasing the number of steps generating pollution loads, for example, greasing, degreasing and pickling.

Economics

No data provided.

Example plants

At the moment, the FIO technique is not in use. However pilot attempts were promoted by the German Ministry for Science and Technology:

- KVS plastics processing and service GmbH: KVS, the developers and manufacturers of the FIO technique, could not establish FIO on the market. The largest problem was the interdependence between the user and the chemicals supplier. For many operators, the level of dependence on the chemical supplier is thought to be too high a risk
- Siemens corporation, -Central Department of Production and Logistics: The silver plating of copper tubes was integrated into the manufacturing process for experimental purpose. The promising beginning was not transferred to mass production because of the sales of that production section to another company
- Bosch: The procedure was technically feasible, however for unknown reasons it was not transferred to mass production. Partial results of the research project (some recycling technologies) are still in use in the company.

Reference literature

BMBF Verbundvorhaben (joint project) 'Manufacturing-integrated surface treatment (FIO)' FKZ 01ZH9503; 01ZH9504/4; 01ZH95098 [104, UBA, 2003]

6.2 Substitution by trivalent chromium plating for hexavalent chromium in hard chromium applications using modified pulse current

Description

The process uses a simplified trivalent chromium electroplating solution based on chromium sulphate. The current waveform is proprietary (patents pending) and includes pulse-reverse current. Chromium has been deposited at up to 250µm successfully and could be deposited to any thickness. Hardness, rate of deposition and post-finishing for thick coatings are the same as for chromium from hexavalent solutions. Colour for thin layers is the same (chrome-blue) as from hexavalent chromium. The process retains the advantages of Cr III solutions, such as lower concentrations, higher current efficiency and tolerance to sulphate and chloride dragged-in from any previous nickel plating stages. Lack of organic additives will reduce or eliminate solution maintenance with activated carbon.

	Plating rate µm/min	Current efficiency	Hardness (VHN*) prior to post-hardening	Process sequence
Automotive OEM** Cr(VI)	0.8	24 %	772	<ul style="list-style-type: none"> • 3-step precleaning • Plating • 1-step post-treatment
Cr(III) process	1.2	30 %	777	<ul style="list-style-type: none"> • 3 step precleaning • Plating • 1-step post-treatment
Note: * VHN = Vickers Hardness Number (measurement of hardness) ** OEM = Original Equipment Manufacturer				

Table 6.1: Comparison of hard chromium plating by traditional Cr(VI) and modified pulse current Cr(III)

Achieved environmental benefits

Replaces hexavalent chromium solutions, with reduced waste gas and waste water treatments. Solution concentrations are the same as existing Cr(III) chemistry and up to ten times lower than Cr(VI) solutions.

Higher current efficiency, therefore less power consumption.

No chloride electrolyte, so no production of chlorine.

Requires no organic additives to suppress chlorine formation, or such as PFOS to suppress mist formation or to improve throw, etc.

A further stage of development will confirm if it can be operated as a closed loop system.

Cross-media effects

None

Operational data: Status of development

The process has been patented and is at pre-production verification in three key projects:

- comparative testing (against Cr(VI) plated components) of 11" (28cm) rotors for pumps handling abrasive slurries (such as in mining, oil exploration and cement handling). Completion Spring 2004
- rollers in large-scale steel rolling mill. Completion in Summer 2004
- compliance with military specifications through an approved Commercial Technology for Maintenance Activity (CTMA) project involving the US Department of Defence and military maintenance depots with the National Centre for Manufacturing Sciences (Michigan, US; CTMA promotes new techniques which reduce health, safety and environmental risks in military applications). Completion in 2005.

Applicability

Intended applicability is full replacement of Cr(VI) electroplating for hard chromium treatments.

Economics

Likely future operating costs: The system is chromium sulphate based, which is currently slightly more expensive than existing Cr(III) chemistry (increased usage may reduce market price). However, no organic additives are used, reducing cost and maintenance. Electricity costs are likely to be half of present costs. Reduced effluent treatment chemicals, and possible reduction in waste produced.

Likely future capital costs: Power supply: up to double the cost of a traditional DC supply. Reduced requirements for waste gas and waste water treatment equipment.

Driving force for implementation

The development of alternatives to using hexavalent chromium electroplating solutions is driven by health and safety in the workplace and environmental toxicity (chromium metal plated on a surface has no adverse health effects). See Section 4.9.6.

Example plants

See Operational data

References

<http://www.nttc.edu/resources/funding/awards/epa/pollution00/Phase2/renz.asp>
<http://www.newmoa.org/prevention/p2tech/> [108, NEWMOA, 2003]

6.3 Substitution by chromium (III) conversion coatings for chromium (VI) conversion layers

Description

Section 4.9.6 describes the drivers to change from Cr(VI) passivation treatments. These are summarised in Driving force for implementation, below.

Achieved environmental benefits

Reduction of Cr(VI) in waste water discharges.

Cross-media effects

Higher process temperature and energy use.

May require additional organic (lacquer) layer.

The complexing agents may have adverse effects in waste water treatment plant.

Operational data

In a research project, supported by the Ministry of Science and Research, SurTech GmbH developed a procedure for the production of 300 nm thick chromium (III) layers on electroplated iron (called Chromitierung). The conversion layer is completely free of hexavalent chrome and has a greenish appearance. This green colour (caused by interference bands) disappears after adding an organic layer. The thickness of the "Chromitierung" layer is reached by a high chrome concentration in the solution, an increased operating temperature of 60 °C and the employment of suitable complex ligands. By using dark pigments into the conversion layer of the "Chromitierung" it can be given a black colour comparable to the black Cr(VI) chromate finishing. Workpieces electroplated with nickel or cobalt can also be treated with chromium (III) layers.

In salt spray tests the corrosion protection of both systems is approximately equal.

Driving force for implementation

The development of alternatives to using hexavalent chromium electroplating solutions is driven by health and safety in the workplace and environmental toxicity (chromium metal plated on a surface has no adverse health effects). See Section 4.9.6.

Example plants

Driving force for implementation

In addition to occupational health issues associated with the use of Cr(VI), the use of Cr(VI) as a passivation (conversion) layer is under pressure because of its restriction in new vehicles by the ELV Directive and its banning in electrical and electronics applications by the RoHS directive see 4.9.6.

Reference literature

A research project of the German Ministry of science and Technology "replacement of Chromium-VI in zinc passivations" Foerderkennzeichen 01ZH9414/7

[98, EC, 2003], [99, EC, 2000]

[http://www.faradaytechnology.com/tech-briefs/Cr\(III\)%20Electroplating%20TECH%20Brief.pdf](http://www.faradaytechnology.com/tech-briefs/Cr(III)%20Electroplating%20TECH%20Brief.pdf)

6.4 Aluminium and aluminium alloy plating from organic electrolytes

Description

The possibility of production scale plating of aluminium onto steel is attractive because of the high corrosion protection such a system offers. It would also enable substitution for more toxic metals such as cadmium, zinc and nickel, as well as chromium used in passivation of zinc, etc.

However it is not possible to electroplate pure aluminium onto steel workpieces from an aqueous solution.

The problem which has not been solved so far industrially, is applying an even, pure aluminium layer on a workpiece, without stressing it thermally. Due to the negative potential of -1.7 V for aluminium in the electromotive series of elements, the electro-chemical deposition from an aqueous solution is not possible in the electroplating shop.

A technology electroplating from non- aqueous solvents has been described for many years on laboratory and pilot scales. It has now been developed for the first time on an industrial scale for plating with aluminium or aluminium-magnesium alloys first in Germany. This has shown the technology to be feasible economically

A production plant with a 3 m³ process tank was built, which can take workpieces up to 1500 x 600 mm. On a three-shift operation a maximum of 30 racks can be treated per day, which corresponds to the capacity of a middle sized electroplating plating unit.

After a conventional pretreatment (degreasing, pickling) the workpieces are dried in a bath with high boiling esters. Because of the high reactivity of the electrolytes with air and water the processing step must take place in a totally enclosed plant. The jigs are placed in the processing vat via an air-lock.

Achieved environmental benefits

Substitution by aluminium for more toxic metals such as cadmium, zinc and nickel. There is no drag out of electrolyte, rinsing or any subsequent waste water and waste.

Cross-media effects

Because of the high reactivity of the electrolytes, the plating part of the plant must be a perfectly closed system.

Emissions to water, to air and/or waste are likely to be:

- waste water from the conventional degreasing and pickles
- toluene from the air-lock and diffuse sources
- waste as used electrolytes.

The used process solution is difficult to deal with and is managed off-site, where any associated emissions of toluene, etc. will occur.

Operational data

As an electrolyte an aluminium alkyl complex dissolved in toluene is used. The anodes consist of super-pure aluminium or aluminium/magnesium alloy. The current yield is almost 100 % and the deposition speed is approximately 10 µm per hour. The service lifetime of the electrolytes is approximately six months. Currently, predominantly steel parts are coated such as screws, nuts, springs, etc., for the automotive industry.

Handling the highly inflammable and explosive electrolytes requires completely new safety precautions, which go a far beyond any normal electroplating shop.

Economics

No data provided

Driving force for implementation

High corrosion protection offered by aluminium coating.
Substitution by aluminium coating for more toxic metals.

Example plants

See Reference literature.

Reference literature

Projects funded by the German Federal Ministry of Science and Technology “Development and testing of a low-waste technology for the electro-deposition of aluminium coatings on all base materials of technical importance” (Sedec Galvano Aluminium KG; FKZ 01ZH 0326 and FKZ 01ZH8501) and UBA-Project: “Development and Scale up of an environmentally friendly galvanic process to deposit high purity aluminium layers on metal pieces” (Aluminal Oberflächentechnik GmbH; FKZ 30441-5/41). [104, UBA, 2003]

6.5 Printed circuit boards

6.5.1 Laser direct imaging

Considerable problems can occur with misalignment or distortion in the production of primary images on inner and outer layers, causing problems with hole alignment. Laser direct imaging is in use for primary imaging, but the technique is too slow for high volume production. It is mainly used for production of prototypes and smaller series.

Laser direct imaging is also being developed for solder mask imaging, but laser imageable solder masks are not available currently available (mid-2004).

Environmental benefits

No films required for the imaging process
No developing media and rinsing processes from diazo silver halide films
More precise imaging and less rejects with better material usage.

Reference literature

[122, UBA, 2003] [159, TWG, 2004]

6.5.2 High density interconnects (HDI)

Description

HDI technology achieves higher packing density of electronic sub-assemblies. A dense primary image is achieved by using new types of hole generation, giving smaller hole diameters and smaller track width.

Smaller holes can be generated by laser, plasma or photo-processes. Development started in the early 1990s but is still not finalised.

Environmental benefit

Smaller sub-assemblies requiring less material.

Reference literature

[122, UBA, 2003]

6.5.3 Embedded passives

Description

Embedded passives is a technology which enables the manufacture of smaller boards with more functionality and improved high frequency performance. The principle is to remove the discrete resistors and capacitors from the surface and embed them in the inner layers of a PCB.

There are several different technologies available for embedded passives, from thin laminate type of materials to various kinds of paste solutions."

Reference literature

[159, TWG, 2004]

7 CONCLUDING REMARKS

7.1 Timing of the work

The first plenary meeting of the TWG was held in April 2002. The first draft was then sent for consultation in August 2003. The comments were assessed and integrated into the document and the second draft, including proposals for BAT conclusions, was sent out in April 2004. The final plenary meeting of the TWG was held in September 2004. After the final meeting, additional data for emissions to water and air associated with BAT were provided. There were short consultations on the modified sections relating to BAT conclusions and on the concluding remarks and executive summary.

7.2 Sources of information

Many documents were sent in by Member States and industry, and over 160 information sources were used in all. The BAT documents from industry and Germany may be considered as cornerstones for the first chapters including the techniques to be considered in the determination of BAT (Chapter 4). These were supplemented by guides on BAT and good environmental practice from France, Spain Belgium, the Netherlands, and the UK. Valuable information on water usage, waste water treatment and emissions and other specific techniques and their implementation in example plants was provided by France and Italy. Industry associations provided important information on specific areas and techniques. Germany provided results of a survey of installations applying multiple best practice techniques. Other countries supplied details on specific techniques, and the UK (as project leader for the OECD task force) supplied new data on PFOS (perfluorooctyl sulphonates) toxicity. Of the new Member States, the Czech Republic and Hungary provided TWG members and contributed information on specific issues. Site visits were made to the UK, Spain, France and Belgium. Throughout the project there was generally good and open communication with experts in industry and regulatory bodies. The consultation rounds provided specific feedback from these experts on applicability and implementation of techniques and additional operational data.

There was a lack of quantitative data which has limited BAT conclusions in some areas. There was also (with noted exceptions) little data on consumptions and emissions from Member States. These topics are discussed in Recommendations for future work, below.

The quality of data in this document lacks consistency and completeness, making conclusions difficult to draw: for example, the consumption and emission levels mentioned in Chapter 3 and 4 range from survey data for specific processes across the EU-15 to data covering several example plants or specific data on specific plants. Important process data, such as type or throughput of the process, were often not given and data in surveys incomplete. The most useful parameters to measure and compare techniques when deriving BAT for this sector are consumption or emission per m^2 . However, although the industry treats surfaces, there is little data available on surface area throughput for the processes in an installation. This is due to the difficulty in calculating the area of the complex shapes of the parts treated, and the variety of parts processed in many installations. Units consumed or emitted with time (e.g. per hour), by kilo of metal used (metal deposited, not substrate), or tonne of substrate throughput are also useful, where given, but also need qualifying data.

Any data provided usually relate to process lines or installations and not to individual techniques within a process line. The lack of specific data for individual processes means that where values for water usage and process material efficiency are given, they are associated with combinations of BAT. Emission levels to water and air are also associated with combinations of several BAT.

Process development in the industry is mainly led by the suppliers of process chemistry and equipment, as the industry comprises a large number of SMEs. However, with the exception of individual experts and companies (particularly on chromium plating), the suppliers did not contribute, in general, to the information exchange. This limited the information available for some processes, and on recent developments, particularly for the substitution by some less toxic chemicals and processes, different equipment types (such as for agitation of process solutions, especially eductors), cooling and heating systems for processes or buildings, and the treatment of water prior to use or re-use.

There was a major information exchange and validation on the substitution in electroplating for hexavalent chromium by trivalent chromium. However, data about the substitution options for passivation with hexavalent chromium were limited to a few operators. No data were received from the EU Ecochrome project which is addressing the environmental problems associated with electroplating with chromium VI, although several contacts were made.

No information was received on the large scale anodising of aluminium as coil, although there is evidence of high throughput, particularly in the production of plates for the printing industry.

When validating information provided by TWG members, very little publicly-available data could be found in Europe. The information was validated by directly contacting the source of the information, individual experts or companies, or with data predominantly from the US.

7.3 Degree of Consensus reached

At the kick off TWG meeting the TWG discussed the 30m³ threshold for the sector and for the purposes of the information exchange and agreed this was the total of the volume of all the process tanks in the installation. This included sprays, although there were differing opinions on including degreasing activities. However, it was agreed that interpretation of this threshold was more important for establishing if an installation needs a permit than determining which processes should be covered in the document. The document therefore covers processes that can occur on any scale, as the volumes of any process tanks meeting the descriptions '*electrolytic or chemical*' are added together (see Annex I of the IPPC Directive).

There was a good general level of consensus overall. The conclusions of the work were agreed at the final TWG meeting in September 2004 and full agreement was reached on all the BAT conclusions, with no split views recorded.

7.4 Recommendations for future work

The information exchange and its result, i.e. this document, present an important step forward in achieving the integrated prevention and control of pollution from the surface treatment of metals and plastics. On some topics, however, better information would allow BAT conclusions to be drawn that are more precise and therefore more helpful. Some issues have been identified in Section 7.2, and are presented below with other issues identified during the information exchange.

Up to date information on process solutions and technique development

- PFOS is a newly identified problem pollutant and appears likely to be controlled across the EU and internationally. It is widely used as a foam suppressant and surfactant, especially in preventing mists in hexavalent chromium plating and alkali non-cyanide zinc plating, as well as improving the quality in other processes. Data should be gathered on the effectiveness of options in operational practice, as well as on PFOS use and emission levels
- hexavalent chromium (Cr(VI)) passivation on an electroplated zinc layer is one of the most widely used treatments. However, the quantity of Cr(VI) left on the surface of parts for the automotive, electronic and electrical goods industries is now controlled by two Directives. The data available showed that current alternatives had cross-media effects such as toxicity and/or higher energy requirements and the TWG concluded that no BAT could be reached for alternatives. Information is required on the emerging options and the associated consumptions and emission levels
- data should be gathered on the EU Ecochrome project.

Quantitative data on achieved environmental benefits, economics and cross-media effects

- Industry and Member States should gather and exchange data in these areas for the techniques described, especially cooling systems, and water use/re-use. For heating techniques, full operational data on all the options are also needed (see Chapter 4). This would allow more specific and more helpful BAT to be concluded and qualified (such as whether BAT applies to new or existing plants). Gathering data of this type may require projects encompassing more than one Member State (possibly organised as a 'club' approach, see 'delivery for future work', below).

Quantitative consumptions and emissions data

Industry and Member States need to collect more information relating techniques to consumptions and emissions (such as those reported in Annex 8.5). Existing data shows some processes to be relatively inefficient. Standardised data sets that are comparable, particularly of raw data, should be collected on more than one installation operating a given technique to determine operating levels associated with individual BAT, as well as groups of BAT that are well-defined. Again, this may require projects encompassing more than one Member State (possibly organised as a 'club' approach, see 'delivery for future work' below), and would allow more useful consumption and emission levels associated with BAT to be concluded, as well as better information on the efficiency of individual processes.

Software for process optimisation

At least one software package for process optimisation has been reported, which uses standard formulae, and most parameters can be varied. Other such packages should be identified. Such software allows operators to simulate a range of BAT before financial commitment, and there is a need for such software in languages other than English, and for a range of activities and scenarios.

Update on progress and application of emerging processes and techniques

Data should be sought on the application and success of the techniques identified in Chapter 6. Information can then be exchanged for the determination of BAT, and the conditions under which the techniques become technically and economically viable.

Other recommendations

Whilst beyond the scope of the document, the following recommendations have arisen from the information exchange and would assist the industry in achieving BAT, as well as increasing its overall sustainability. Members States, regulators and industry are recommended to adopt these initiatives.

- **strategy for environmental goals and R&D for the sector**

The surface treatment sector serves many different industries, and lacks a unified voice for focusing awareness and attracting funding for research, development and other projects. Most operators in the sector are SMEs, and R&D is largely carried out by suppliers. To overcome this problem in the US, a working group representing operators, suppliers, industry professionals and regulators has produced two strategic documents. Parallel documents could readily be developed in Europe and would benefit the implementation of BAT by providing data for future drafts of this document as well as assisting overall progress towards sustainability such as:

- strategic environmental goals for the sector. A short list of specific environmental goals (seven were identified in the US), could provide a summary of the environmental benefits the sector as a whole could achieve using BAT, with the priorities and the time-scales they could be achieved in
- an industry list of research priorities. An EC list of research priorities for the sector, which is publicly available to advise universities, research bodies, other research programmes, etc. This should identify the gaps in knowledge in this document

- **delivery for future work**

In Europe, several co-operative or 'club' activities already assist SMEs in delivering environmental objectives. This type of 'club' approach could be used to deliver the further work identified:

- in the UK and the Netherlands, 'club' activities have been organised to enable SMEs to gain mutual benefits, such as sharing the cost of consultancy advice for environmental permitting and regulation. In both cases, this has been with the collaboration of regulators, who also benefited in significant time saving.
- In Italy, ECOMETAL is a non-profit consortium aimed at moving the whole metal finishing sector into the framework of sustainable development. These types of activities could be used to deliver some of the proposals here.

- **increase economic viability of third party recovery**

Although outside the scope of this document, third party recovery and disposal has to be used in many cases. The fragmented nature of the business leads to the disposal of wastes as hazardous because the quantities are below economically viable recovery. The types of wastes, their quantities and locations need to be identified so that they may be recoverable in larger quantities. This development would also lend itself to a 'club' approach. Involving regulators would assist with regulatory issues, such as transfrontier shipment of wastes, recognition of activities for recovery and not disposal, etc.

- **development of the infinitely recyclable concept**

The Italian non-profit consortium ECOMETAL has started a project to label goods 'infinitely recyclable'. This project aims to:

- update knowledge about the recycling of goods made of metals
- investigate alternative processes that are able to increase the percentage of metals that are recycled
- certify that metallic components are recyclable for manufacturers, producers and consumers.

The intended output for the first two tasks is the development of protocols that establish the characteristics that both the base and finishing metals must meet to be suitable for recycling using simple, economic and reliable techniques.

- **development of performance-based standards to increase acceptance of new techniques**

A barrier to the acceptance of substitute techniques and processes by the sectors' customers was identified during this information exchange: contracts for surface treatment regularly specify the process. Specifying the process restricts the uptake of substitute processes that use less toxic materials, and/or have other environmental benefits, such as lower energy consumption. In reality, the requirements are for performance, such as corrosion resistance, colour and hardness, etc. There have been some programmes to develop performance-based standards, but these need to be continued, and accompanied by the development of training packages for operators and customers to increase the uptake of these standards.

7.5 Suggested topics for future R&D projects

Electroless nickel and copper

Electroless process solutions have a very limited life, unlike electroplating solutions. This is described by the number of times the amount of metal in solution is applied (metal turnovers, MTO). MTO is usually 6 – 8 times or less, depending on the quality required. The electroless process is also inherently less stable than electrolytic solutions, with more solution being discarded due to problems. In many cases, the solutions are discarded as hazardous waste, while containing significant amounts of metals. Research should be carried out to:

- extend bath lives in terms of MTO
- develop techniques to recycle or re-use the solutions
- improve recovery options for metal from discarded baths.

Modulated current techniques and equipment

Modulated current plating techniques are used in high precision applications, such as printed circuit boards. An emerging technique is described which is under pre-production testing for plating hard chromium from a trivalent chromium solution. While equipment costs are estimated to be double, the technique simplifies the chemical requirements, and cuts energy and chemical consumption significantly. There is a need for further investigation of modulated current techniques, as the cost of equipment has fallen in real terms, due to the increased application in PCB manufacture.

New techniques to measure surface area and throughput factors

As noted above, although the industry treats surfaces, usually the surface area of a component is not usually known. The industry could improve its control of raw materials and energy, as well as improving quality if the surface area, and therefore the process throughput could be easily measured. Methods are needed that are rapidly usable and cheap to operate, whether physical, physico-chemical or software packages that assist the calculation. The methods also need to establish relationships between surface area and other throughput factors such as weight of anode material used, weight of substrate throughput, etc.

Improved efficiency of processes

The data supplied showed poor efficiency of some processes (see Chapter 3). Research is needed to improve the process efficiency or identify suitable substitutes.

The EC is launching and supporting, through its RTD programmes, a series of projects dealing with clean technologies, emerging effluent treatment and recycling technologies and management strategies. Potentially these projects could provide a useful contribution to future document reviews. Readers are therefore invited to inform the EIPPCB of any research results which are relevant to the scope of this document (see also the preface of this document).

Substitutes for passivation using hexavalent chromium

The use of hexavalent chromium from passivation left in major product groups is being limited or banned by two directives (applying to end of life vehicles and waste electrical and electronic goods). The TWG could not identify substitutes that were BAT and further work is required in this area, either to identify substitutes for the hexavalent passivation that have less cross-media effects or to identify surface treatment systems that can be used to replace the systems requiring passivation.

REFERENCES

- 1 EC (1996). "Council Directive 96/61/EC of 24 September 1996 concerning integrated pollution prevention and control", Official Journal of the European Communities (OJ), L257 vol 39, pp. 15.
- 2 EC (2000). "Commission Decision of 17 July 2000 on the implementation of a European pollutant emission register (EPER) according to Article 15 of Council Directive 96/61/EC concerning integrated pollution prevention and control C(2000) 2004", Official Journal of the European Communities, L192.
- 3 CETS (2002). "Reference document on best available techniques for the surface treatment of plastic and metals using electrolytic or chemical process", CETS.
- 4 Cramb, A. W. "A Short History of Metals", Carnegie Mellon University, <http://neon.mems.cmu.edu/cramb/Processing/history.html>.
- 5 Hook, P. and Heimlich, J. E. (2003). "A History of Packaging", Ohio State University, <http://ohioline.osu.edu/cd-fact/0133.html>.
- 6 IHOBE (1997). "Recubrimientos Electrolíticos", Gobierno Vasco.
- 8 Nordic-Council (2002). "DEA- an aid for identification of BAT in the inorganic surface treatment industry", TemaNord, Nordic Council of Ministers, TemaNord 2002:525.
- 9 ESTAL (2002). "Presentation by ESTAL" ESTAL, *Seville*.
- 11 Tempany, P. (2002). "STM TWG kick off meeting report" STM TWG kick off meeting, *Seville*.
- 12 PARCOM (1992). "PARCOM Recommendation 92/4 on the reduction of emissions from the electroplating industry", PARCOM, 92/4.
- 13 UNEP; MAP and RAC/CP (2002). "Alternatives for preventing pollution in the surface treatment industry", RAC/CP (Regional Activity Centre for Cleaner Production of the Mediterranean Action Plan), UNEP, WAP, Ministry of the Environment Spain, Government of Catalonia Ministry of the Environment,.
- 16 RIZA (1999). "Best safety practice for preventing risks of unplanned discharges", RIZA.
- 18 Tempany, P. (2002). "Site visit reports, Mission 1 UK", EIPPCB, DG-JRC, EC.
- 19 Eurofer (2003). "Draft Reference document on best available techniques in the continuous electrolytic coating of steel", Eurofer.
- 20 VITO (1998). "Beste Beschikbare Technieken voor het Elektrolytisch behandelen, chemisch behandelen en ontvetten", VITO.
- 21 Agences de l'Eau de France; SITS; SATS; CETIM and Ministère de L'Amenagement du Territoire et de l'Environnement (2002). "Surface Treatment Waste water Treatment", Agence de l'Eau Rhone-Mediterranée-Corse, 2-9506252-3-1 (EN), 2-9506252-2-3 (FR).
- 22 Fraunhofer (2002). "Comprehensive preliminary studies and proposals for measures of risk reduction strategies for EDTA", Fraunhofer ISI and Fraunhofer IME, ÜBA.

References

- 23 EIPPCB (2002). "Reference Document on Best Available Techniques on Emissions from Storage", EIPPCB, EC.
- 24 UBA-Austria (2001). "State-of-the-art for the production of nitric acid with regard to the IPPC Directive", ÜBA-Austria.
- 26 Envirowise (2003). "Electroplaters plant performance optimisation tool", DEFRA, <http://www.envirowise.gov.uk/envirowisev3.nsf/Key/CROD4TGK79?OpenDocument>.
- 28 DG-RTD, E. (2002). "EU Workshop on waste prevention and chromium issues in industrial effluents" EU Workshop on waste prevention and chromium issues in industrial effluents, *Lulea, Sweden*.
- 29 EA (2001-3). "IPPC: Interim guidance for Surface treatment of metals or plastics - by chemical or electrolytic means, Draft", Environment Agency for England and Wales, SEPA, NIESH.
- 30 EC (2003). "Council Directive 2003/53/EC of 18 June 2003 amending for the 26th time the Council Directive 76/769/EEC relating to restrictions on marketing and use of certain substances and preparations (nonylphenol, nonyl phenol ethoxylate and cement)", Official Journal of the European Union (OJ), pp. 4.
- 31 Biowise (2001). "Biological solution for cheaper metal cleaning", Department of Trade and Industry, Case study 6.
- 34 Brett, P. C. (2002). "Electrolytic processes", IUPAC, personal communication.
- 35 Columbia (2002). "Electrolysis", Columbia Electronic Encyclopedia 6th Edn.
- 36 IUPAC (1997). "Compendium of Chemical Technology: IUPAC Recommendations, 2nd edn 1997", IUPAC, ISBN 0865426848.
- 38 Ullmann (2002/3). "Ullman's Encyclopedia of Industrial Chemistry, 6th edn, 2001 electronic release".
- 39 (1993). "Dictionary of Science", Penguin, 0-14-051262-4.
- 41 (2003). "Gold facts", Fine Things, www.finethingsjewelry.com.
- 42 SEA (2001). "Code of Good Safety Practice for the Surface Finishing Industry", Surface Engineering Association, Environment Agency, SEPA, HSE.
- 43 SEA (2001). "Trivalent Chromium for a safer workplace and environment", SEA.
- 44 France, T. (2003). "Accidents", French national technical working group for IPPC in the surface treatment of metals and plastics.
- 45 France, T. (2003). "Aluminium anodising".
- 46 France, T. (2003). "Cleaning degreasing solutions by centrifuge".
- 47 France, T. (2003). "Chemical milling".
- 48 France, T. (2003). "Closed loop chromium plating".
- 49 France, T. (2003). "Copper recovery by electrodeposition".

- 51 France, T. (2003). "Emission levels".
- 53 France, T. (2003). "Recovery systems for aluminium from anodising".
- 55 France, T. (2003). "Nickel recovery by reverse osmosis".
- 56 France, T. (2003). "Self monitoring".
- 57 France, T. (2003). "Static separator for degreasing activities".
- 58 France, T. (2003). "French regulations for surface treatment activities".
- 59 France, T. (2003). "Ultrafiltration of degreasing solutions".
- 60 Hemsley, D. (2003). "The PPC Regulations and their impact on the chemical engineering of process plating plant", Transactions of the Institute of Metal Finishing (UK), 81(3), pp. 4.
- 61 EC (2002). "Definition of small and medium enterprises (SME)", European Commission, http://europa.eu.int/comm/enterprise/consultations/sme__.
- 62 France, T. (2003). "Recovery systems for aluminium in anodising".
- 65 Atotech (2001). "Integrated vertical systems for pcb production - Aurotech".
- 66 PPRC (2003). "Chromium electroplating and anodising tanks", Pacific Northwest Pollution Resource Center, www.pprc.org/pprc/sbap/facts/chrome.html.
- 67 IAMS (2003). "A Pollution Prevention Resource Manual for Metal Finishers", Institute of Advanced Manufacturing Sciences, Inc.
- 68 USEPA (2003). "Research in support of the metal finishing industry", USEPA, www.epa.gov/ORD/NRMRL/std/mtb/metal_finishing.htm.
- 69 NCDPPEA (2003). "Overview of the Metal Finishing Industry", North Carolina Division of Pollution Prevention and Environmental Assistance, www.p2pays.org/ref/03/02454/overview.htm.
- 70 Ellis, J. B. (2001). "Sewer infiltration/exfiltration and interactions with sewer flows and groundwater quality" Interurba II, *Lisbon, Portugal*.
- 71 BSTSA "Metal Pre-treatment".
- 73 BSTSA "Electroless Nickel".
- 74 BSTSA "Hard Chromium".
- 75 BSTSA "Precious Metals".
- 76 BSTSA "Laquers for Metal Finishing".
- 77 BSTSA "Electroplated Plastic Components".
- 78 BSTSA "Zinc Plating".
- 80 INRS "Guide pratique de ventilation: Cuves de traitementsde surface", 2.

References

- 81 INRS (1998). "Ateliers de traitement de surface: Prévention des risques chimiques", ED 827.
- 82 Agences de l'Eau (1996). "Prevention des pollutions accidentelles dans les industries de la chimie, du traitement de surface, etc."
- 85 EIPPCB "Reference Document on Best Available Techniques for Industrial Cooling Systems", EC.
- 86 EIPPCB "Reference Document on Best Available Techniques in the Ferrous Metals Processing Industry", EC.
- 87 EIPPCB "Reference Document on Best Available Techniques in the Waste Water and Waste Gas Treatment/ Management Systems in the Chemical Sector", EC.
- 88 EIPPCB "Reference Document on Best Available Techniques on Economics and Cross-Media Effects", EC.
- 89 EIPPCB "Reference Document on Best Available Techniques for the Waste Treatment Industries", EC.
- 90 EIPPCB "Reference Document on Best Available Techniques for Surface Treatment using Solvents", EC.
- 91 EIPPCB "Reference Document on the General Principles of Monitoring", EC.
- 92 EC (1991). "Council Directive of 12 December 1991 on hazardous waste", Official Journal of the European Communities, L377.
- 93 EC (2000). "Directive 2000/60/EC of the European Parliament and the Council of 23 October 2000 establishing a framework for Community action in the field of water policy", Official Journal of the European Communities, L327, pp. 72.
- 94 EC (1999). "Council Directive 1999/31/EC of 26 April 1999 on the landfill of waste", Official Journal of the European Communities, 182.
- 95 EC (1986). "Council Directive of 12 June 1986 on the protection of the environment and in particular of the soil, when sewage sludge is used in agriculture", Official Journal of the European Communities, L181.
- 96 EC (2003). "Directive 2002/96/EC of the European Parliament and of the Council of 27 January 2003 on waste electrical and electronic equipment (WEEE)", Official Journal of the European Communities, L37.
- 97 EC (1999). "Council Directive 1999/13/EC of 11 March 1999 on the limitations of emissions of volatile organic carbon compounds due to the use of organic solvents in certain activities and installations", Official Journal of the European Communities (OJ), L85.
- 98 EC (2003). "Directive 2002/95/EC of the European Parliament and of the Council of 27 January 2003 on the restriction of the use of certain hazardous substances in electrical and electronic equipment", Official Journal of the European Communities (OJ).
- 99 EC (2000). "Directive 2000/53/EC of the European Parliament and of the Council of 18 September 2000 on end-of-life-vehicles", Official Journal of the European Communities (OJ), L269.

- 100 EC (2000). "The Hazardous Waste List: Commission Decision (2000/532/EC) of 3 May 2000 replacing Decision 94/3/EC establishing a list of wastes pursuant to Article 1(a) of Council Directive 75/442/EEC on waste and.....", Official Journal of the European Communities, L226.
- 101 CEN (2000). "Corrosion protection of metals and alloys - Surface treatment, metallic and other inorganic coatings - Vocabulary: EN 12508", CEN, 0 580 34230 1.
- 103 EC (1991). "Council Directive of 18 March 1991 amending Directive 75/442/EEC on waste", Official Journal of the European Communities, L78.
- 104 UBA (2003). "Draft German BREF: Treatment of metallic and non-metallic surfaces with chemical and electrochemical procedures", ÜBA.
- 105 EC (1967). "Council Directive 67/548/EEC of 27 June 1967 on the approximation of laws, regulations, and administrative provisions relating to the classification, packaging and labelling of dangerous substances (as amended)", Official Journal of the European Communities, P 196, 16/08/1967 p.0001-0008.
- 106 NCMS (2003). "Recent Alternatives for chromate coatings", National Centre for Manufacturing Sciences, USA, <http://chromate.ncms.org/about.htm>.
- 108 NEWMOA (2003). "Trivalent chromium replacements for hexavalent chromium plating", North East Waste Management Officials'Organisation.
- 109 DEFRA (2004). "Perfluorooctane sulphonate Risk reduction strategy and analysis of advantages and drawbacks & review of environmental risks - Stage 3 report", DEFRA, j454/PFOS RRS.
- 110 BEWT (2003). "Chemelec cell", BEWT, personal communication.
- 111 ACEA (2003). "Comments on STM BREF draft 1".
- 112 Assogalvanica (2003). "Comments on STM BREF draft 1".
- 113 Austria (2003). "Comments on STM BREF draft 1".
- 114 Belgium (2003). "Comments on STM BREF draft 1".
- 115 CETS (2003). "Comments on STM BREF draft 1".
- 116 Czech-Republic (2003). "Comments on STM BREF draft 1".
- 118 ESTAL (2003). "Comments on STM BREF draft 1".
- 119 Eurofer (2003). "Comments on STM BREF draft 1".
- 120 Finland (2003). "Comments on STM BREF draft 1".
- 121 France (2003). "Comments on STM BREF draft 1".
- 122 UBA (2003). "Draft German BREF: Printed circuit board manufacture", ÜBA.
- 123 UBA (2004). "German reference plants", ÜBA Germany, personal communication.
- 124 Germany (2003). "Comments on STM BREF draft 1".

References

- 125 Ireland (2003). "Comments on STM BREF draft 1".
- 126 Netherlands (2003). "Comments on STM BREF draft 1".
- 127 Oekopol (2003). "Comments on STM BREF draft 1".
- 128 Portugal (2003). "Comments on STM BREF draft 1".
- 129 Spain (2003). "Comments on STM BREF draft 1".
- 131 OSPAR (2002 ongoing). "List of substances of possible concern", OSPAR, 2002-17.
- 132 Sheasby, P. G. and Pinner, R. (2002). "The surface treatment and finishing of aluminium and its alloys 6th edn Vol 1", Finishising Publications Ltd., SG1 4BL UK, ASM International, Ohio 44073-0001 USA, ISBN 0904477231.
- 133 Hensel, K. B. (2002). "Electropolishing, Metal finishing guidebook and directory, Vol 100, 1A".
- 134 CEN/BSI (1997). "Electropolishing", CEN, BSI, BS EN 3769: 1997.
- 135 Swain, J. (1996). "Electropolishing stainless steel for the pharmaceutical, food and beverage industries", Surface World, May 1996.
- 136 Webber, J. and Nathan, S. (2000). "A process with POLISH", Process Engineering, April 2000.
- 137 ISO/BSI (2000). "Electropolishing", ISO, BSI and other standards organisations, BS ISO 15739: 2000.
- 138 QUALANOD (1999). "Specifications for the quality label for Anodic Coatings on Wrought Aluminium for Architectural Purposes", QUALANOD, Edition: October 1999.
- 139 Wikipedia (2004). "Printed circuit board", Wikipedia, http://en.wikipedia.org/wiki/Printed_circuit_board.
- 140 Atotech (2003). "Integrated chromium plating plant - Dynachrome".
- 142 EC (1996). "Council directive on the control of major-accident hazards involving dangerous substances, amendment 2003/105/EC", OJ.
- 143 EC (2001). "Commission decision 2455/2001/EC Establishing a list of priority substances in the water field", OJ.
- 144 EC (1976). "Council directive of 27 July 1976 on the approximation of the laws, regulations and administrative procedures of the Member States relating to restrictions on the marketing and use of certain dangerous substances and preparations 7/769/EEC", OJ, OJ L 262, 27.9.1976, p 201.
- 145 LeCarre (2004). "Surface area calculation", Agence de l'Eau Seine Normandie, personal communication.
- 146 ZVO (2003). "Decorative high gloss chromium plating and functional chromium plating", ZVO.

- 147 CETS (2004). "Technical arguments for chromium plating from trivalent and hexavalent electrolytes", CETS.
- 148 HTMLA (2003). "Fact sheet: plating with trivalent chrome", Hazard and toxic materials office, Board of Public Works, City of Los Angeles, <http://es.epa.gov/techinfo/ca-htm/htmfact9.html>.
- 149 PPT (2004). "Replacing hexavalent chromium", <http://www.nam.org?PPT/autopanelpresentation.ppt>.
- 150 Rowan (2003). "Chrome plating alternatives", Rowan Technology Group, <http://www.rowantechnology.com/Tech-Info.htm>.
- 152 ESTAL (2004). "ESTAL TWG supplementary information", ESTAL, personal communication.
- 154 NMFRC (2004). "Pollution prevention and control technologies for plating sources (NCMS-NAMF Blue Book)", National Metal Finishing Resource Centre, <http://www.nmfrc.org/bluebook/tocmain.htm>.
- 155 EIPPCB "Reference Document on Best Available Techniques in the Non Ferrous Metals Industries", EC.
- 156 France, T. (2003). "Water Treatment".
- 157 ACEA (2004). "Comments on STM BREF draft 2".
- 158 Portugal (2004). "Comments on STM BREF draft 2".
- 159 TWG (2004). "Comments on STM BREF draft 2".
- 160 ESTAL (2004). "Comments on STM BREF Draft 2".
- 161 Assogalvanica (2004). "Comments on STM Draft 2".
- 162 USEPA (2000). "Approaching zero discharge in surface finishing", USEPA, EPA/625/R-99/008.
- 163 Gock and Schlmroszyk (2004). "Aufbereitung von Phosphatierschlamm aus der Automobilindustrie", *Stoffstrommanagement*, pp. 895-899.
- 164 Wittel (2004). "Phosphating", Chemetall GmbH, personal communication.
- 165 Tempany (2004). "Final TWG meeting report".
- 166 RIZA (2004). "Cross-media analysis and provisionanl cost calculation of the re-use of rinse water in chemical nickel plating", RIZA, RIZA werkdoucnent nr. 2004.096x.

GLOSSARY

General Glossary

1. General terms, abbreviations, acronyms and substances

ENGLISH TERM	MEANING
A	
A	ampere
ABS	any of the class of plastics based on acrylonitrile-butadiene-styrene copolymers
A/dm ² , A/m ²	amperes per square decimetre, amperes per square metre. A measure of current density at the electrode.
AC	alternating current
acid	proton donor. A substance that, more or less readily, gives off hydrogen ions in a water solution
ACGHI	American Conference of Governmental Industrial Hygienists. This organisation produces various standards for industrial hygiene/workplace safety
achieved environmental benefits (See Chapter 4)	main environmental impact(s) to be addressed by the technique (process or abatement), including emission values achieved and efficiency performance. Environmental benefits of the technique in comparison with others
acute effect	an adverse effect on any living organism in which severe symptoms develop rapidly and often subside after the exposure stops.
acute pollution	pollution arising from infrequent events, unplanned events or accidents (see also: chronic pollution)
acute toxicity	adverse effects that result from a single dose or single exposure of a chemical; any poisonous effect produced within a short period, usually less than 96 hours. This term is normally used to describe effects in experimental animals.
aeration	the act of mixing a liquid with air (oxygen).
aerobic	a biological process that occurs in the presence of oxygen
air knife	a machine using low pressure, high volume air emitted through precision slits, giving a laminar air curtain. Components can be passed through this curtain, either manually or on a conveyor belt, or as a coil. The air heats up due to compression and movement in the system, and this warms oils and greases, assisting their removal. Both the air movement and the temperature facilitates drying of components. Also used in other industries, such as for finishing chocolates
alkali	proton acceptor. A substance that, more or less readily, takes up hydrogen ions in a water solution.
anaerobic	a biological process that occurs in the absence of oxygen.
anion	a negatively charged ion; an ion that is attracted to towards the anode in electrochemical reactions
anode	positive electrode
anodising (GB) anodizing (US)	anodic oxidation. Electrolytic process in which the surface layer of a metal, such as aluminium, magnesium or zinc is converted to a coating, usually an oxide, having protective, decorative or functional properties [101, CEN, 2000]
AOCl	adsorbable organic chlorine compounds
AOX	adsorbable organic halogen compounds. The total concentration in milligrams per litre, expressed as chlorine, of all halogen compounds (except fluorine) present in a sample of water that are capable of being adsorbed on activated carbon.

ENGLISH TERM	MEANING
APE	alkyl phenol ethoxylates
applicability (see Chapter 4)	Consideration of the factors involved in applying and retrofitting the technique (e.g. space availability, process specific)
aquifer	a water-bearing layer of rock (including gravel and sand) that will yield water in usable quantity to a well or spring.
assimilative capacity	the ability of a natural body of water to receive waste waters or toxic materials without harmful effects and without damage to aquatic life
ATBC	acetyl tributyl citrate
autocatalytic plating	deposition of a metallic coating by a controlled chemical reduction that is catalysed by the metal or alloy being deposited [101, CEN, 2000]
B	
bactericide	a pesticide used to control or destroy bacteria
barrel	Also called or translated as drum. A rotating container used to contain workpieces when they are treated in bulk:
barrel processing	surface treatment activities carried out using barrels. For example, barrel cleaning, barrel electroplating
BAT	best available techniques
bath	a solution of chemicals for a specific surface treatment activity, e.g. pickling bath. Also refers to the relevant vat or workstation in a process sequence
BF	batch wise flocculation
big bag, or bulk bag	large bag for containing and/or delivering solids. Usually contains approximately one tonne depending on the material density and is designed to be compatible with pallet handling systems
biodegradable	that can be broken down physically and/or chemically by micro-organisms. For example, many chemicals, food scraps, cotton, wool and paper are biodegradable.
BOD	biochemical oxygen demand: the quantity of dissolved oxygen required by micro-organisms in order to decompose organic matter. The unit of measurement is mg O ₂ /l. In Europe, BOD is usually measured after 3 (BOD ₃), 5 (BOD ₅) or 7 (BOD ₇) days.
BREF	BAT reference document
bulk bag	see big bag
C	
carcoat	potassium monopersulphate
CASS	copper accelerated salt spray test. A standard corrosion test
cathode	negative electrode
cation	a positively charged ion: an ion that is attracted towards the cathode in electrochemical reactions
CF	continuous flocculation
CNC	computer numeric control
COD	chemical oxygen demand: the amount of potassium dichromate, expressed as oxygen, required to oxidise chemically, at about 150 °C, substances contained in waste water. However, COD _{Cr} also includes any inorganic reducing agents present.. High Chloride (>1000mg/l also interferes with the results. The ISO standard for COD is ISO 15705:2002. TOC is also a measure of organic compounds in waste water
CPI	corrugated plate interceptor - oil separation device utilizing inclined corrugated plates to separate free non-emulsified oil and water based on their density difference
chelating agent	a compound capable of chelation with metal ions.

ENGLISH TERM	MEANING
chelation	the formation of a closed ring of atoms by the attachment of compounds or radicals to a central polyvalent metal ion (occasionally non-metallic).
chronic pollution	pollution occurring from regular or continuous events, such as effluent discharge (see acute pollution)
coil processing	processing of continuous coils of substrate. The largest scale activities are for steel (up to 2080 mm wide) or aluminium, although copper, brass, nickel, and zinc are also processed in coils. Coils can also be on a smaller scale (a few mm wide) for decorative trim
complexing agent	see chelating agent
containment, contained area	(secondary) containment refers to additional protection against storage tank releases over and above the inherent protection provided by the tank container itself. There are two major types of secondary containment for leakages, namely those that are part of the tank construction, such as, double tank bottoms (only for aboveground tanks), double skinned and double walled tanks and impervious barriers which are placed upon the soil surface below the tanks [90, EIPPCB,]
corrosion	surface chemical reaction especially on metals, by the action of moisture, air or chemicals.
cross-media effects (See Chapter 4)	Any side-effects and disadvantages caused by implementation of the technique. Details on the environmental problems of the technique in comparison with others
D	
DAF	dissolved air flotation
DC	direct current (electrical supply)
DDC	dithiocarbamate
deburring	removal of burrs or sharp edges by electropolishing, grinding, finishing or pickling
DEA	Data envelope analysis; a method of benchmarking and/or analysing data
de-embrittlement	a specific type of embrittlement of a metal or alloy caused by absorption of atomic hydrogen, for example, during electroplating, cathodic cleaning, or pickling processes and manifested by delayed fracture, brittle fracture or a reduction of ductility [101, CEN, 2000]
description (see Chapter 4)	Technical description of the technique
dialysis	a separation technique: the separation of colloids in solution from other dissolved substances by selective diffusion through a membrane
diffuse emission	emissions arising from direct contact of volatile or light dusty substances with the environment (atmosphere, under normal operating circumstances). These can result from: <ul style="list-style-type: none"> • inherent design of the equipment (e.g. filters, driers, etc.) • operating conditions (e.g. during transfer of material between containers) • type of operation (e.g. maintenance activities), or • from a gradual release to other media (e.g. to cooling water or waste water). Fugitive emissions are a subset of diffuse emissions.
diffuse sources	sources of similar diffuse or direct emissions which are multiple and distributed inside a defined area
displacement coating	see immersion coating
DNC	direct or distributed numeric control. A system where a NC program is sent from a PC to a CNC machine.
DOS	dioxy sebacate

ENGLISH TERM	MEANING
drag-in	liquid (from a previous bath) carried into a bath by the workpieces or substrate introduced during treatment
drag-out	liquid carried out of a bath by the workpieces or substrate during treatment
driving force for implementation (see Chapter 4)	reasons for implementation of the technique (e.g. other legislation, improvement in production quality)
DS	dry solids (content). The mass of a material remaining after drying by the standard method of test
DSA	dimensionally stable anodes. Metal anodes that are not consumed during use as graphite anodes are, hence dimensionally stable.
E	
EC50	effect concentration 50. The concentration at which effects are observed in 50 % of the test population after administering a single dose. Effects include the immobilisation of daphnia, inhibition of growth, cell division or biomass production, or the production of chlorophyll by algae.
ECCS	electro-chemical chromium plating
Economics (see Chapter 4)	information on costs (investment and operation) and any possible savings (e.g. reduced raw material consumption, waste charges) also as related to the capacity of the technique
EDT	
EDTA	ethylenediaminetetraacetic acid. An important chelating agent
EDDS	ethylene diamine disuccinate
eco rinse	a static rinse tank where workpieces are passed through before and after plating, allowing the collected drag-out to be re-used as drag-in
effluent	physical fluid (air or water together with contaminants) forming an emission
EIPPCB	European IPPC Bureau
electrode	a conductor by which an electric current enters or leaves an electrolyte in an electro-chemical reaction (or an electric arc or a vacuum tube) [101, CEN, 2000], See anode and cathode
electrogalvanising	a term often used to translate the German <i>galvanische Metallabscheidung</i> , or similar terms from other languages. Should not be used in English, as it is easily confused with <i>hot dip galvanising</i> .
electroless plating	see autocatalytic plating. Use of this term discouraged [CEN, 2000 #101
electrolyte	a substance that is capable of conducting an electric current in solution or fused state
electroplating	electrodeposition of an adherent metallic coating upon an electrode for the purpose of securing a surface with properties or dimensions different from those of the base metal (see electrogalvanising, galvanising. German = galvanische Metallabscheidung). Note: plating alone cannot be used in this sense. [101, CEN, 2000]
electropolishing	smoothing and brightening of a metal surface by making it anodic in an appropriate solution [101, CEN, 2000]
emerging techniques	Novel techniques that are relevant to the document (see the BREF outline and Guide). The name of the standard chapter in BREFs where novel techniques are identified.
emission	the direct or indirect release of substances, vibrations, heat or noise from individual or diffuse sources in the installation into the air, water or land
consumption and emission levels associated with the	

ENGLISH TERM	MEANING
use of BAT	
emission limit values	the mass, expressed in terms of certain specific parameters, concentration and/or level of an emission, which may not be exceeded during one or more periods of time
EMS	environmental management system
end-of-pipe technique	a technique that reduces final emissions or consumptions by some additional process but does not change the fundamental operation of the core process. Synonyms: "secondary technique", "abatement technique". Antonyms: "process-integrated technique", "primary technique" (a technique that in some way changes the way in which the core process operates thereby reducing raw emissions or consumptions)
ENSA	ethoxylated alpha-naphthol sulphonic acid
EOP, EoP, eop	end-of-pipe
EP	electrostatic precipitator
etching	In general, the removal of part of a metal surface by the action of acid or alkali. This can be used to describe the removal of the top surface of metal, together with dirt and oxides, etc, prior to subsequent treatment. Used before anodizing, etching employs an alkaline solution where micro galvanic activity at the alloy surface leads to the development of a matt appearance. [118, ESTAL, 2003]
EU-15	the 15 Member States at 26 June 2002. Most of the data in this document pre-dates the EU-25. Data from the new Member States is indicated where it is provided.
eutrophication	the pollution of a body of water by sewage, fertilisers washed from the land, and industrial wastes (inorganic nitrates and phosphates). These compounds stimulate the growth of algae, reducing the oxygen content in the water, and so killing animals with a high oxygen requirement.
example plants (see Chapter 4)	reference to a plant where the technique is reported to be used
existing installation	an installation in operation or, in accordance with legislation existing before the date on which this Directive is brought into effect, an installation authorized or in the view of the competent authority the subject of a full request for authorisation, provided that that installation is put into operation no later than one year after the date on which this Directive is brought into effect
F	
flight bar	the assembly used both to move the jigs through the core process steps and (where the processes depends on electrical current) to carry the electrical current to the jig
flocculation	the coagulation of finely divided particles into particles of greater mass [39, 1993]
fugitive emission	emission caused by non-tight equipment/leak: emission into the environment resulting from a gradual loss of tightness from a piece of equipment designed to contain an enclosed fluid (gaseous or liquid). Fundamentally caused by a difference of pressure and a resulting leak. Examples of fugitive emissions: leak from a flange, a pump, a sealed or tightened equipment...
G	
galvanising	In UK English: hot dip metal coating (German: Schelztauchüberzug; French: galvanisation à chaud). A term often used to wrongly translate the German <i>galvanische Metallabscheidung</i> , or similar words from other languages. This term should be translated into English by electroplating

ENGLISH TERM	MEANING
global warming	greenhouse effect: The short wave solar radiation passes through the Earth's atmosphere but after being reradiated by its surface as infrared radiation, some of it is absorbed by gases in the atmosphere causing a rise in temperature (known as global warming). It is calculated that 55 % of global warming is caused by absorption of energy by CO ₂ . The remaining 45 % is caused mainly by energy absorption by methane and damage to the ozone layer as a result of the use of various VOX
H	
HC	Hydrocarbon
HDI	High density interconnects. A type of printed circuit board with multiple layers and a high density of interconnections between the layers.
I	
IEF	Information Exchange Forum (informal consultation body in the framework of the IPPC Directive)
immersion coating	metal produced by a replacement reaction in which one metal is replaced by another from the solution [101, CEN, 2000]. For example: $\text{Fe} + \text{Cu}^{2+} \rightarrow \text{Cu} + \text{Fe}^{2+}$ (also known as displacement coating)
installation	in the IPPC Directive, a stationary technical unit where one or more activities listed in Annex I are carried out, and any other directly associated activities which have a technical connection with the activities carried out on that site and which could have an effect on emissions and pollution
IPPC	integrated pollution prevention and control
J	
Jig, or rack	a frame for suspending workpieces during surface treatment activities. In electrochemical activities, the rack also carries current to the workpieces
JIT	just-in-time; a manufacturing management technique, when components are delivered for the next stage of assembly just as they are needed, and not held in stock
jobbing shop, job shop	specialist surface treatment company operating as a sub-contractor in the engineering industries
K	
Knoop	Knoop units are a measure of hardness
L	
LAS	linear alkylbenzene sulphonate
LC50	lethal concentration 50. The lowest concentration of a substance in water or ambient air in milligrams per litre sufficient to cause death in 50 % of the test population within a defined period (e.g. 96 hours for fish, 48 hours for daphnia).
LD50	lethal dose 50. The lowest dose of a substance administered to species such as mice and rats sufficient to cause death in 50 % of the test population within a defined period (no more than 14 days), expressed in milligrams of test substance per kilogram of bodyweight.
legionella (English)	a genus of gram-negative bacilli that includes species that cause Legionnaires' disease (légionellose, French; Legionärskrankheit, German, legionella sometimes in Spanish)

ENGLISH TERM	MEANING
linishing	directional grinding of flat surfaces by means of an abrasive bonded to an endless flexible belt (US: graining) [101, CEN, 2000]
looper unit	unit in coil coating that contains loops of the continuous substrate. In entry loopers the length of the loops is decreased, allowing the end of the substrate to remain motionless when attaching a new coil; in exit loopers the loops are increased in length while holding the receiving coil motionless while cutting the end of a completed roll
LPG	liquified petroleum gas. A mixture of petroleum gases, usually propane and butane, that is stored under pressure as a liquid
M	
MAC	maximum allowable concentration
macrothrowing power	ability of an electroplating solution to produce a coating with a surface smoother than that of the substrate. cf. throwing power [101, CEN, 2000]
metallizing metallising	application of a metallic coating to the surface of non-metallic material Note: It is recommended to restrict the term metallizing to this meaning and in particular not to use it as a synonym for metal spraying or in the sense of depositing a metallic layer on a metallic substrate [101, CEN, 2000]
microelectronics	the brand of electronics that deals with miniature components
microrough	microscopic irregularities in the surface of a material
microthrowing power	ability of an electroplating solution under a specific set of conditions to deposit metal in pores or scratches Note: Good microthrowing power does not necessarily imply good macrothrowing power [101, CEN, 2000]
MLB	Multilayer board. A printed circuit board with more than one layer.
monitoring	process intended to assess or to determine the actual value and the variations of an emission or another parameter, based on procedures of systematic, periodic or spot surveillance, inspection, sampling and measurement or another assessment methods intended to provide information about emitted quantities and/or trends for emitted pollutants
MSA	methane sulphonic acid
MTO	metal turnover. The number of times the original quantity of metal in a bath is replenished (or turned over) by additions
multi-media effects	where effects can apply to more than one media, e.g. to air and water. See <i>cross-media effects</i>
N	
n/a	not applicable OR not available (depending on the context)
NC	numerically controlled
n/d	no data
NO _x	oxides of nitrogen
NPE	nonyl phenyl ethoxylate
NTA	nitrioloacetic acid
O	
O&M	operations and maintenance in this document. (May also mean organisation and methods, relating to work planning)
OEM	original equipment manufacturer. a company that supplies equipment to other companies to resell or incorporate into another product using the reseller's brand name, e.g. the manufacturer of components to major automotive manufacturers

ENGLISH TERM	MEANING
operational data (see Chapter 4)	performance data on emissions/wastes and consumption (raw materials, water and energy). Any other useful information on how to operate, maintain and control the technique, including safety aspects, operability constraints of the technique, output quality, etc.
operator	any natural or legal person who operates or controls the installation or, where this is provided for in national legislation, to whom decisive economic power over the technical functioning of the installation has been delegated
OSPAR	the 1992 OSPAR Convention, combined the 1972 Oslo Convention on dumping of waste at sea and PARCOM (see below). The work under the Convention is managed by the OPSAR Commission
P	
PARCOM	the 1974 Paris Convention on land-based sources of marine pollution. The PARCOM Commission was the forum through which the Contracting Parties cooperated. It has now been superceded by the 1992 OSPAR Convention (see above)
Pcb, PCB	(i) printed circuit board. An electronic circuit in which the wiring between components and certain fixed components themselves are printed on an insulating board. (Notes: 1. This is the main use in this document. 2. Flexible films and other substrates can be instead of insulating board) [39, 1993] (ii) polychlorinated biphenyl. Chlorinated derivatives of biphenyl. Bioaccumulable toxic compounds use din synthetic resins and as electrical insulators. The only use in this document is discussing chemicals potentially used in installations of this sector (see Section 4.1.1.1) [39, 1993]
PFOS	Perfluorooctane sulphonate: a surfactant. See Annex 8.2
pickling	for metal: removal of oxides or other compounds from a metal surface by chemical or electrochemical action [101, CEN, 2000] for plastic: a mixture of chromic and sulphuric acid applied to ABS-type plastic surfaces to oxidise and dissolve the butadiene component, thus generating a microrough surface as part of the preparation for autocatalytic plating (German: Beizen, although Dekapieren seems to fit the same description)
plant	machinery or factory. A large item of equipment or an assembly of equipment, e.g. a plant for sub-contact surface treatment, a plant for chromium electroplating
plating	A widely used abbreviation of 'electroplating', which is the more correct term
PSA	phenyl sulphonic acid
PI	process-integrated
polishing, mechanical	smoothing of a metal surface by action of abrasive particles
pollutant	individual substance or group of substances which can harm or affect the environment
primary measure/technique	a technique that in some way changes the way in which the core process operates thereby reducing raw emissions or consumptions (see <i>end-of-pipe technique</i>)
profiles, architectural	workpieces and substrate manufactured to specific cross-sectional dimensions and cut to size for assembly and use in the building construction industry. For example, door and window frames

ENGLISH TERM	MEANING
PS	presensitised; used in this document with lithographic plates which are surface treated with a photosensitive coating as part of the manufacturing process, and prior to distribution.
PTFE	polytetrafluoroethylene
pth	plating through hole. This is a technique for Printed Circuit Boards. Plating through the holes provides electrically conductive connections between the conductor tracking planes on both sides of a double sided board or between the multiple tracking planes of Multi layer Boards (MLBs) Note: do not confuse with through hole construction, which is a type of PCB construction where the wires of components are placed through holes drilled through the board. This has now largely been superseded by surface mounted components.
Q	
QAC	quaternary ammonium compound
QMS	quality management system
R	
rack, or jig	frame for suspending workpieces during surface treatment activities. In electrochemical activities, the rack also carries current to the workpieces
reference conditions	conditions that are specified, e.g. in connection with operating a process, collecting samples, etc.
reflow	the melting of an electroplated tin coating to give a bright finish
rectification	Rectification is the reworking of products with reject quality surface treatment to the required specification. In practice, the terms reworking and stripping are sometimes confused and may be used to indicate both activities.
rinse criterion	Rinse ratio of contaminant to solvent, usually water, to be achieved
Rz	Measure of roughness of a surface
S	
secondary measure/technique	see <i>end-of-pipe technique</i>
sequestration	The process of 'locking up' metal ions in co-ordination compounds to make them ineffective. the sequestering agents used for this purpose are usually chelating agents
SME	small and medium enterprise(s), see [61, EC, 2002]
solubility product	the product of the concentrations of the ions of a dissolved electrolyte when in equilibrium with undissolved substance
specific emission	emission related to a reference basis, such as production capacity, or actual production (e.g. mass per tonne or per unit produced)
SPC	statistical process control; a process management technique. Regular measurements of process parameters (such as bath temperature, pH, concentration of key process components) are analysed on a continuous basis to ensure compliance within statistical parameters (such as 3 x the standard deviation) to control the quality of the process
SS	suspended solids (content) (in water) (See also TSS)
strip, stripping	process or solution used for the removal of a coating from a base metal or undercoat. See <i>rectification</i>
STM	surface treatment of metals and plastics. Refers to topics within the scope of this document

ENGLISH TERM	MEANING
T	
TA Luft	German Federal Regulation for control of pollution to air
TDS	total dissolved solids
throwing power	improvement of coating (usually metal) distribution over that given by the primary current distribution on an electrode (usually a cathode) in a given solution, under specified conditions. Note: the term may also be used for anodic processes for which the term is analogous such as: macrothrowing power [101, CEN, 2000]
TOC	total organic carbon: a measure of organic compounds in waste waters. Does not include other reducing agents in the determination (unlike CODCr). The European Standard method for total organic carbon (TOC) is; EN 1484
TS	total solids (content). Solid content before drying of the material
TSS	total suspended solids (content) (in water) (See also SS)
tumbling	bulk processing in barrels in either the presence of abrasives or burnishing shot for the purpose of improving the surface finish
TWG	technical working group
U	
unplanned release	an emission that is not planned for, and is therefore not authorised by a permit. For example, a spillage of a liquid that travels to surface or groundwater, or a discharge to a waste water treatment plant that exceeds the planned capacity of the treatment. It may be acute (i.e. happening in a short period of time, often called an accidental emission, such as a spillage) or chronic (i.e. happening over a long period of time, such as leak from a tank)
US	(i) American English (ii) United States of America
uv	ultraviolet light
V	
valorise	to get the value from, or add value to, something,. For example, valorise a sludge containing metals by using the sludge as a raw material in a metallurgical plant (a smelter), and recovering the metals
VHN	Vickers Hardness Number (measurement of hardness)
vs.	versus: used to compare two ideas or sets of data, etc.
V.I.	viscosity index
VOC	volatile organic compounds (includes VOX and non-VOX compounds)
VOX	volatile organic halogenated compounds
W	
WHB	waste heat boiler
WWTP	waste water treatment plant
weak emulsion solution	a weakly emulsifying solution used for degreasing. The oils in the solution can be easily removed enabling the cleaned solution to be re-used ((<i>demulgen</i> is one trade name)
wetting agent	substance that reduces the surface tension of a liquid. This allows the liquid to spread more easily and more uniformly on a solid surface
X	
Y	
Z	

2. Common units, measurements and symbols

TERM	MEANING
A	ampere
AC	Alternating current
ACkWh	kilowatt-hours (alternating current)
amp	ampere
A/dm ² , A/m ²	amperes per square decimetre, amperes per square metre. A measure of current density at the electrode.
atm	normal atmosphere (1 atm = 101325 N/m ²)
bar	bar (1013 bar = 1 atm)
barg	bar gauge (bar + 1 atm)
°C	degree Celsius
cgs	centimetre gram second. A system of measurements now largely replaced by SI.
cm	centimetre
cSt	centistokes = 10 ⁻² stokes
d	day
DC	direct current
g	gram
GJ	gigajoule
Hz	hertz
h	hour
ha	hectare (10 ⁴ m ²) (=247105 acres)
J	Joule
K	kelvin (0 °C = 273.15 K)
kA	kiloamp(ere)
kcal	kilocalorie (1 kcal = 4.19 kJ)
kg	kilogram (1 kg = 1000 g)
kJ	kilojoule (1 kJ = 0.24 kcal)
kPa	kilopascal
kt	kilotonne
kWh	kilowatt-hour (1 kWh = 3600 kJ = 3.6 MJ)
l	Litre
m	metre
m ²	square metre
m ³	cubic metre
mg	milligram (1 mg = 10 ⁻³ gram)
MJ	megajoule (1 MJ = 1000 kJ = 10 ⁶ joule)
ml	millilitre
mm	millimetre (1 mm = 10 ⁻³ m)
m/min	metres per minute
Mt	megatonne (1 Mt = 10 ⁶ tonne)
Mt/yr	megatonnes per year
mV	millivolts
MW _e	megawatts electric (energy)
MW _{th}	megawatts thermal (energy)
ng	nanogram (1 ng = 10 ⁻⁹ gram)
Nm ³	normal cubic metre (101325 kPa, 273 K)
Pa	pascal
Poise	viscosity measurement: 1 Poise = 0.1 Pascal second
ppb	parts per billion
ppm	parts per million (by weight)
ppmv	parts per million (by volume)

TERM	MEANING
s	second
S	siemens, the SI unit measure of conductance
St	stokes. An old, cgs unit of kinematic viscosity. 1 St = 10^{-6} m ² /s
t	metric tonne (1000 kg or 10 ⁶ gram)
t/d	tonnes per day
t/yr	tonne(s) per year
V	volt
vol-%	percentage by volume. (Also % v/v)
W	watt (1 W = 1 J/s)
wt-%	percentage by weight. (Also % w/w)
yr	year
val/l	valency per litre
~	around; more or less
ΔT	increase of temperature
μm	micrometre (1 μm = 10 ⁻⁶ m)
Ω	ohm, unit of electrical resistance
Ω cm	ohm centimetre, unit of specific resistance
% v/v	percentage by volume. (Also vol-%)
% w/w	percentage by weight. (Also wt-%)

3. List of chemical elements

NAME	SYMBOL	NAME	SYMBOL
actinium	Ac	mercury	Hg
aluminium	Al	molybdenum	Mo
americium	Am	neodymium	Nd
antimony	Sb	neon	Ne
argon	Ar	neptunium	Np
arsenic	As	nickel	Ni
astatine	At	niobium	Nb
barium	Ba	nitrogen	N
berkelium	Bk	nobelium	No
beryllium	Be	osmium	Os
bismuth	Bi	oxygen	O
boron	B	palladium	Pd
bromine	Br	phosphorus	P
cadmium	Cd	platinum	Pt
calcium	Ca	plutonium	Pu
californium	Cf	polonium	Po
carbon	C	potassium	K
cerium	Ce	praseodymium	Pr
caesium	Cs	promethium	Pm
chlorine	Cl	protactinium	Pa
chromium	Cr	radium	Ra
cobalt	Co	radon	Rn
copper	Cu	rhenium	Re
curium	Cm	rhodium	Rh
dysprosium	Dy	rubidium	Rb
einsteinium	Es	ruthenium	Ru
erbium	Er	rutherfordium	Rf
europium	Eu	samarium	Sm
fermium	Fm	scandium	Sc
fluorine	F	selenium	Se
francium	Fr	silicon	Si
gadolinium	Gd	silver	Ag
gallium	Ga	sodium	Na
germanium	Ge	strontium	Sr
gold	Au	sulphur	S
hafnium	Hf	tantalum	Ta
helium	He	technetium	Tc
holmium	Ho	tellurium	Te
hydrogen	H	terbium	Tb
indium	In	thallium	Tl
iodine	I	thorium	Th
iridium	Ir	thulium	Tm
iron	Fe	tin	Sn
krypton	Kr	titanium	Ti
lanthanum	La	tungsten	W
lawrencium	Lr	uranium	U
lead	Pb	vanadium	V
lithium	Li	xenon	Xe
lutetium	Lu	ytterbium	Yb
magnesium	Mg	yttrium	Y
manganese	Mn	zinc	Zn
mendeleevium	Md	zirconium	Zr

8 ANNEXES

8.1 Metals and compounds in relevant legislation and agreements

Metal and compounds►		Copper	Chromium	Lead	Nickel	Zinc
▼European directive, regulation, or International treaty	Cadmium					
Commission decision on the implementation of a European pollutant emission register (EPER) for IPPCD [2, EC, 2000]	Threshold air kg/yr: 10 Threshold water kg/yr: 5	100 50	100 50	200 20	50 20	200 100
Council Directive 67/548/EEC as amended: Classification, packing and labelling [105, EC, 1967]	The proposed human health classification is: Carcinogen category 2, R49 (may cause cancer by inhalation); R48/23/25 (toxic: danger of serious damage to health by prolonged exposure through inhalation and if swallowed); Mutagen category 3, R68 (possible risk of irreversible effects); Reprotoxic category 3, R63 (possible risk of harm to the unborn child); and possibly R37 (irritating to the respiratory system). It is proposed to class it as dangerous for the environment: very toxic to aquatic organisms and may cause long-term adverse effects in the aquatic environment (R50/53).	No	Current/proposed classification: CrO ₃ : toxic/very toxic (Carcinogen category 1) Na ₂ Cr ₂ O ₇ , Chromium (VI) compounds (with exceptions): Carcinogen category 2	Lead compounds except where specified elsewhere: Reprotoxic category 1	Nickel oxides and sulphides: Carcinogen category 1	Zinc chromates (Cr(VI) is the controlled substance): Carcinogen category 1
Commission regulation (EC) no 143/97 of 27 January 1997 concerning the third list of priority substances as foreseen under Council Regulations (EEC) No 793/93 (Review of risk and risk reduction strategies)	Cadmium, cadmium oxide	No	Chromium trioxide Potassium dichromate Sodium chromate Sodium dichromate Ammonium dichromate	No	Nickel Nickel sulphate	No
Council Directive 96/82/EC on the control of major accident hazards involving dangerous substances (Seveso II Directive)	Toxic: triggers Seveso II at 100 tonnes		Very toxic: triggers Seveso II at five tonnes			

Metal and compounds▶							
▼ European directive, regulation, or international treaty	Cadmium		Copper	Chromium	Lead	Nickel	Zinc
Council Directive 76/769/EEC as amended: Restrictions on marketing and use [144, EC, 1976]	Yes: May only be used in aeronautical, aerospace, mining, offshore and nuclear sectors. Also in some safety devices for transport, and electrical contacts in any sector.		No	As hexavalent chromium	Yes, but not applicable to STM uses	Nickel metal and compounds: Not to be used in jewellery or garment fasteners, with some exceptions	Not applicable to STM uses
Council Directive 86/278/EEC: sewage sludge used in agriculture [95, EC, 1986]	Yes		Yes	Yes	Yes	Yes	Yes
Decision 2455/2001/EC: Establishing a list of priority substances in the field of water quality [143, EC, 2001]	Yes (X)		No	No	Yes (X ***)	Yes	No
	X = priority hazardous substance, aimed for cessation or phasing out of discharges, emissions, and losses within 20 years.						
	*** = subject to a review for possible identification as a priority hazardous substance.						
Directive 2002/95/EC: Restriction of use in electrical and electronic equipment [2, EC, 2000]	Yes	No		As hexavalent chromium	Yes in solders	No	No
Directive 2000/53/EC: End of life vehicles [99, EC, 2000]	No	No		As hexavalent chromium	Yes (except for petrol tanks and PCBs)	No	No
OSPAR Convention list of substances of possible concern [131, OSPAR, 2002 ongoing]	Yes	No		No	No	No	No

Table 8.1: Metals and compounds in relevant legislation and agreements

8.2 PFOS (perfluorooctane sulphonate) in the surface treatment of metals and plastics

[109, DEFRA, 2004] PFOS related compounds are polymers of high molecular weights in which PFOS is only a fraction of the polymer and final product. They have surface active properties and high resistance to oxidation which makes them useful in a number of applications. This Annex, and the reports it refers to, relates to PFOS and those substances that break down to PFOS.

In metal finishing they are used in additives to reduce surface tension and to prevent mist formed by gas evolution at electrodes during plating. They are widely used in hexavalent chromium plating to reduce the workplace air concentration of hexavalent chromium. They are also used in a similar way in anodising and acid pickling.

Other known surface finishing uses are:

- in copper plating, preventing haze by regulating foam and improving bath stability while improving brightness and adhesion
- in nickel plating, as non-foaming surfactants, reducing the surface tension and increasing strength of the electroplate by eliminating pinholes, cracks and peeling
- in tin plating producing a uniform coating thickness
- to impart a positive charge to fluoropolymer particles and to aid electroplating of polymers (e.g. PTFE) onto steel.

Overall usage in the EU-15 in metal finishing is estimated to be three to nine tonnes per year.

The major worldwide producer of PFOS (3M, US) took voluntary action in 2000 to withdraw most uses of the substance from the market.

The US and UK jointly agreed, in conjunction with the OECD Task Force on Existing Chemicals, to work together on a hazard assessment: the US worked on human health and the UK on environment. This hazard assessment was completed and subsequently endorsed by the OECD TF (late in 2002). The conclusions were that PFOS is persistent, bio-accumulative and toxic, and this is a cause of concern for the environment and humans.

Given these inherent properties and evidence of exposure, a risk reduction strategy (RRS) was initiated in the UK. Whilst this is a UK activity, it follows European guidance as laid out under the Existing Substances Regulation Technical Guidance Document. In this way, it is the UK's intention to make it useful to other Member States and indeed any other country that may wish to use the results.

Whilst the RRS is explicitly a UK activity only, the EU and a number of EU Member States have expressed an interest in this work.

The strategy will be finalised and published by the UK in March 2004.

8.3 Examples of regulatory emission limit values

	PARCOM	Belgium	France ¹	Germany	England & Wales ²	Italy ³	Netherlands	Spain	Portugal
Discharge to public sewer (PS) or surface water (SW)	PS or SW		SW		Indicative BAT values to PS	SW			
Ag	0.1	0.1		0.1	0.1		0.1		
Al		10.0	5.0	3.0		1.0		1.0 – 2.0	5.0
Cd	0.2 ⁴	0.6	0.2	0.2	0.01	0.02	0.2	0.1 – 0.5	0.2
CN free	0.2		0.1	0.2	0.2	0.5	0.2	0.5 – 1.0	0.1
Cr(VI)	0.1 ⁵	0.5	0.1	0.1	0.1	0.2	0.1	0.2 – 0.5	0.1
Cr total	0.5 ⁵	5.0	3.0	0.5	1.0	2.0	0.5	Cr(III) 2.0 – 4.0	Cr(III) 3.0
Cu	0.5 ⁵	4.0	2.0	0.5	2.0	0.1	0.5	0.2 – 10.0	2.0
F		10.0	15.0	50		6		6.0 – 12.0	15.0
Fe		20.0	5.0	3.0		2.0		2.0 – 10.0	5.0
Hg	0.05 ⁴		0.1			0.005	0.05	0.05 – 0.1	0.05
Ni	0.5 ⁵	3.0	5.0	0.5 -1	1.0	2.0	0.5	2.0 – 10	5.0
NO ₂			1.0			0.6			1.0
P		2.0	10	2		10	15	10 – 20	10
Pb	0.5 ⁵	1.0	1.0	0.5		0.2		0.2 – 0.5	1.0
Sn	2.0	2.0	2.0	2.0	2.0	10	2.0	10.0	2.0
Zn	0.5 ⁵	7.0	5.0	2.0	2.0	0.5	0.5	3.0 – 20	5.0
COD		300	150	400		160			150
EDT				0			0		
HC Total			5.0	0.1	0.1	5	0.1	20 – 40	
VOX	0.1			1.0	0.1		0.1		
Settleable solids					50				60
Total load of salts			No limits regionally partly for sulphates	No limits			No limits		
Total load of heavy metals	(see note 5)		15	No limits			50kg/y/factory, 20kg/y/metal	3	Sum of all metals 15 – 20 mg/l

HC: Hydrocarbons

1. France: water consumption: 8 litres per square metre of treated surface for each rinsing stage.

2. Environment Agency for England and Wales: these are indicative BAT standards from guidance for permit writing expected to be reached by the application of BAT

3. Lower limits are provided by law for some areas (i.e. catchment basin of the Lagoon of Venice) [112, Assogalvanica, 2003]

4. PARCOM: for waste water streams treated specifically [12, PARCOM, 1992]

5. PARCOM plants discharging small loads of metals (defined as: sum of total chromium, copper, lead, nickel and zinc less than 200 g/day prior to end-of-pipe treatment on demonstration by the applicant) may be subject to limit values up to a maximum four times higher for total chromium, copper, lead and nickel. This is to be granted by the competent authority.

Table 8.2: Emission limit values for surface treatment waste water in Europe (values in mg/l) (CETS)

In Finland there are no national emission limit values for discharges from surface treatment plants. Usually waste waters from surface treatment plants are discharged to the public sewer and each water works sets its own limit values for industrial waste waters. However, emission limit values used by the Helsinki Water Company are also widely applied in other water service plants. In addition, there is the Helcom Recommendation (23/7) for reduction of discharges and emissions from metal surface treatment, which is used in writing environmental permits. Besides the concentration (mg/l) limit, load (kg/d) is also usually defined. Load is determined on a case by case basis. Table 8.3 presents emission limit values which are used at the Helsinki Water Company and values given in the Helcom recommendation:

Substance	Example of emission limit values to Helsinki waste water treatment works	Helcom Recommendation guidelines (23/7)
Cadmium	0.01 mg/l	0.20 mg/l
Mercury	0.01 mg/l	0.05 mg/l
Chromium (Cr-total)	1.0 mg/l	0.7 mg/l
Chromium (VI)	0.1 mg/l	0.2 mg/l
Copper	2.0 mg/l	0.5 mg/l
Lead	0.5 mg/l	0.5 mg/l
Nickel	0.5 mg/l	1.0 mg/l
Silver	0.2 mg/l	0.2 mg/l
Zinc	3.0 mg/l	2.0 mg/l
Tin	2.0 mg/l	
Unbound cyanide		0.2 mg/l
Cyanide (total)	0.5 mg/l	
Volatile organic halogens (VOX)		0.1 mg/l
Sulphate, thiosulphate, sulphite (total)	400 mg/l	

Table 8.3: Helsinki Water Co. and Helcom emission limit values for industrial waste waters

Substance	Classification	Dangerous material reference number (Germany)	Maximum job concentration	TA Luft
Nitrogen oxides (NO _x)	<ul style="list-style-type: none"> • fire supporting • corroding 	TRGS 900	5 mg/m ³	350 mg/m ³
Hydrogen fluoride (HF)	<ul style="list-style-type: none"> • very toxic • corroding 	TRGS 900	2.5 mg/m ³	3 mg/m ³
Hydrogen chloride (HCl)	<ul style="list-style-type: none"> • corroding 	TRGS 900	8 mg/m ³	30 mg/m ³
Sulphuric acid (SO _x)	<ul style="list-style-type: none"> • corroding 	TRGS 900	1 mg/m ³	350 mg/m ³
Aerosols with NaOH	<ul style="list-style-type: none"> • corroding 	TRGS 900	2 mg/m ³	n/a
Chromium (VI) compounds	<ul style="list-style-type: none"> • toxic • environmentally dangerous 	TRGS 900	0.1 mg/m ³	0.05 mg/m ³

Table 8.4: Air pollutants in surface technology [104, UBA, 2003]

Noise

French regulations impose emission values for noise, depending on the local environment; an sound level between 3 and 6 dB(A) above the background level is prescribed outside the plant [121, France, 2003].

PCB (printed circuit board) pollutant concentration in effluents

Table 8.5 shows the most common concentrations of pollutants in effluents of a typical PCB production which discharges into a public sewer.

Parameter	German limit values in mg/l (taken according to regulations or as two hour composite)
AOX	1
Arsenic	0.1
Lead	0.5
Chromium	0.5
Chromium VI	0.1
Cyanide	0.2
Copper	0.5
Nickel	0.5
Silver	0.1
Sulphide	1
Tin	2

Table 8.5: Typical limit values for discharge of waste waters from PCB manufacture to public sewer

When discharging into watercourses, in addition to the values mentioned above the following values are required:

Parameter	German limit values in mg/l (taken according to regulations or as two hour composite)
Nitrogen of ammonium compounds	50
Chemical oxygen demand	600
Iron	3
Fluoride	50
Hydrocarbons	10
Phosphorus	2
Fish toxicity (T_F)	6

Table 8.6: Typical values addition parameters for discharge from PCB manufacture to watercourse

8.3.1 Regulations applicable to surface treatment activities in France

The pollution and nuisances caused by surface treatment mostly result from the use and handling of toxic products, which also necessitate the adoption of strict safety and hygiene measures in workshops.

The main pollutants are identified in Section 1.4.

For these reasons, surface treatments are directly or indirectly subject to various regulations, notably those resulting from the law on installations classified for protection of the environment, but also from the water law and the law on chemical products. In some cases, town planning regulations may also prevent the installation of a surface treatment workshop.

The main national regulations presented below directly or indirectly concern surface treatments. These regulations, which are liable to change, are those in force on the date of construction of the installation. They are also without prejudice to any specific regulations which might apply locally. For these reasons, for any project involving the creation, modification or even the shutting-down of a workshop, it is recommended to contact the classified installations inspection body (regional department of industry, research and environment), which is responsible for specifying the regulations which actually apply to the case in question.

Town planning constraints

The construction of a classified installation usually requires a building permit, which must be applied for at the same time as the authorisation under the classified installations legislation or the submission of the declaration.

Classified installations legislation

The prevention of pollution due to industrial installations is covered by a specific legislative framework, i.e. the legislation on installations classified for protection of the environment (environment code art. L.511-1 and following – former law of 19 July 1976).

- **Authorisation and declaration systems**

Surface treatment activities subject to the authorisations system must meet the requirements of prefectural orders drawn up in particular on the basis of the minimum requirements defined nationally by the ministerial order of 26 September 1985.

- **Order of 26 September 1985**

Issued in application of article 7 of the law of 19 July 1976 (L.512-5 of the environment code), the ministerial order of 26 September 1985 (Official Journal of 16 November 1985) establishes the regulation framework applicable to surface treatment workshops subject to authorisation. It is the result of reflection on regulations initiated in 1972 (circular of 4 July 1972, followed by the circular of 22 March 1983

- **Standard order 2565**

The order of 30 June 1997 establishes the regulation framework for surface treatment workshops covered by Section 2565, which are subject to declaration.

Water law

The legislation on water (environment code - Art. L.210-1 and following) is intended to ensure balanced management of water resources.

Health legislation

The disposal of non-domestic waste water in a public sewerage network is a fairly common practice, particularly in food industries. In practice, this solution is also quite often used by small businesses or small industrial structures, including surface treatment workshops.

Waste

The surface treatment industry produces considerable quantities of metallic hydroxide sludges, which constitute special industrial wastes (SIW) as defined by decree no. 97-517 of 15 May 1997 relating to the classification of dangerous wastes. Some 175000 tonnes per year of hydroxide sludge is produced by France, and approximately 1000000 tonnes per year by the European Union [source: Cetim].

Soil pollution

Surface treatment workshops are frequently the cause of serious pollution of soils and groundwaters. Sites whose soil has been polluted by industrial activities are managed within the framework of regulations relating to classified installations

Polluting substances

The order of 26 September 1985 regulates a clearly defined activity, namely the surface treatment activity (sector approach).

Solvents

- **Solvents harmful for the aquatic environment**

The orders of 2 October 1991 regulate the disposal in water of trichloroethene (trichlorethylene), tetrachloroethene (perchlorethylene), and 1,2-dichloroethane (methylene chloride), including in their uses as surface degreasing products, in application of Directive 76/464/CEE.

- **Volatile organic compounds**

European Council Directive 99/13/EC of 11 March 1999 aims to reduce emissions due to the use of solvents in industry by 57 % between now and 2007. Surface treatment workshops may enter into the field of this Directive for metal cleaning and degreasing operations and the application of certain paints and varnishes. The transposition of this Directive into French law for these activities subject to authorisation is carried out by amendment of the order of 2 February 1998 (order of 29 May 2000 and order to be issued).

Environmental management

In addition to the regulations aspect, the importance of voluntary actions aimed at a constant improvement of a company's results in environmental terms is underlined. There are numerous reasons (image, responsibility, long-term strategy) for the head of a company to commit himself to an environmental management policy.

8.4 Monitoring

The reference document on the general principles of monitoring [91, EIPPCB,] provides wide-ranging guidance on all aspects of monitoring. Details on calculating water consumption are given in Section 3.2.2 of this document. Some issues specific to the sector are given in the sections below.

8.4.1 General issues for monitoring in the surface treatment of metals and plastics

8.4.1.1 Organic carbon

In some cases, besides chemical oxygen demand (COD) also total organic carbon (TOC) could be determined from waste waters. TOC describes the amount of organic compounds in waste water, which can either be biologically degradable or not. COD method oxidises almost all types of organic compounds and most inorganic reducing agents. High chloride concentration (1000 mg/l) in waste water can disturb COD determination. EN 1484 is the European standard method for total organic carbon (TOC) and the ISO standard for COD is ISO 15705: 2002.

8.4.1.2 Air monitoring

In Section 3.3.3, the data from CETS UK are from samples taken according to the following procedures:

Stack velocity, temperature measurements and total particulate matter (including chromium) were made according to BS EN 13284:2002 and BS ISO 9096:2003. Particulate samples were taken with a Stackmite 9096 sampling train. Chromium determinations were by atomic absorption spectroscopy. Periodic sampling for halides (chlorides) was by using a calibrated pump connected to an impinger sampling train containing solutions of 0.1N sulphuric acid and 0.1N sodium hydroxide, based on USEPA 26. Analysis was by ion chromatography. The sampling and laboratory work was carried out by a contractor accredited under ISO 9002, and the contractor is accredited for most of the laboratory methods (except chloride) under UKAS.

8.4.2 Self monitoring of aqueous effluents from the surface treatment of metals and plastics

Introduction

[56, France, 2003] The application of self-monitoring is based on regular analyses of the effluents with two aims:

- compliance with the concentration of the various species and their flows, whose limits are defined by a public authority (regulator)
- taking corrective actions where necessary.

Determination of a polluting load requires:

- measurement of the continuous flow
- sampling
- analyses.

Measurement of a continuous flow

The measurements of continuous flows are important, particularly their precision and their reliability. Sound knowledge of the water flows enables the use of sampling equipment, to calculate pollutant loads and to determine the correct dimensions for waste water treatment equipment.

Whatever the type of apparatus used, measurement must include a recording of the flows and a sum of the volumes. All the measurement equipment must be calibrated and regulated by an organisation or a skilled person once every year at least.

There are two methods of measurement:

- open channel
- closed control, pipework or circuit.

Flow measurement in open channel is a question of obtaining a relation between the flow and the water level in the measurement equipment (Venturi channels, sluices or spillways, gauges) which produce a standing head of water for measurement. The flow is calculated with water level measure or pressure measure. The most used sensors are:

- bubble meters, which have good measurement precision but are sensitive and require careful maintenance
- ultrasound (ultrasonic) sensors not in contact with the effluents, but not usable with foam and moisture condensation on the ultrasonic head can cause interference
- depth gauge floats.

Flow measurement in closed control:

- electromagnetic measuring apparatus
- ultrasonic measuring apparatus
- vortex effect measuring apparatus.

The accuracy of these can be affected by particulates and entrained air bubbles or foam in the pipework.

Sampling

The equipment must allow a representative sampling of the effluents. The place of the intake point has to be chosen so that:

- the effluent's speed is not modified by constrictions or obstacles
- the effluent must be homogeneous
- the intake point must be located at a sufficient distance from the last connection of a line for adequate mixing.

If necessary, a mixing station can be used without modifying the quality of released water.

Sampling should be proportional to the flow of effluent except in the case of a constant flow after a buffer tank, for example:

- types of sampling systems: by suction and by pumping
- they must allow a sufficient intake speed (superior or equal to 0.5 m/s)
- they must be equipped with suction and repression pipes with a minimum internal diameter of 9 mm
- they must be equipped with a system of sequential purging of the suction pipe
- they must be equipped with a thermally insulated or refrigerated enclosure at 4 °C when necessary (such as for COD, BOD analysis) for a good conservation of the samples.

Other samples should be taken as needed to ensure the effluent complies with the permitted conditions, such as maximum concentration or value (such as for pH).

Samples should not be filtered before analysis [12, PARCOM, 1992].

Validation

The operator should have a duplicate analysis made on the same sample by an approved laboratory at least once a year.

The exterior process of validation is based on:

- the checking of the lines of flows and the sampling (a control once a year at least)
- analytical control of the lines (one to four times per year according to the installation size)
- constitution of two series of samples starting from the same batch and sending of a batch to an approved laboratory (same conservation conditions, simultaneous start of the analyses).

Analyses of samples

Reference methods are:

1. Molecular absorption spectrophotometry or colorimetry

The element or species to be estimated is combined with a reagent to form or destroy a coloured complex. This complex is soluble in water or in an organic phase. A light beam is passed through the solution to be analysed. A fraction of the incidental light is retained or absorbed by the solution proportionally to the concentration of the absorbing substance. The proportion of absorptive light at a specific wavelength is determined using an optical device (monochromator) associated to an electronic measurement.

Advantages

- very simple technique
- some equipment is portable
- method usually sensitive enough to reach the discharge limits imposed.

Disadvantages

- prone to interferences because not always specific of the species to be determined (the guide elements can react with the reagent or the entity to be proportioned or the elements to be proportioned can be in presence of coloured elements)
- may not be sensitive enough for some limit values (e.g. cadmium).

2. Atomic absorption spectroscopy

The element to be analysed is at high temperature resulting in a break of the molecular bonds and creating free atoms. These atoms have the property to absorb visible or ultraviolet luminous radiations at wavelengths which are specific to each other.

Absorption is proportional to the quantity of atoms crossed by radiation thus giving access to the concentration of the element.

The source of ionisation is made up with a flame in which the solution is nebulised or an electrothermic system (furnace) in which the solution is injected.

Advantages:

- good method usable for estimating all metal cations, more selective, more sensitive and faster than the others, more expensive too but economic within a reasonable time when a large number of analyses are required.

Disadvantages

- this method can only be used in a laboratory.

3. Inductive coupling plasma emission spectrometry

A gas is ionised (argon) in a torch (tube with quartz) surrounded by an inductor connected to a high frequencies generator functioning at constant frequency.

An aerosol of the sample to be analysed is injected into this plasma with a pneumatic nebulisator. The atom radiation is decomposed in spectral lines by a diffraction pattern.

The light intensity of these lines is converted into concentration of the required chemical elements.

Advantages:

- achieves a very low detection limit, simultaneous proportioning of trace elements and strongly concentrated elements, suppression of interferences, proportioning of Cr.

Disadvantages:

- very expensive equipment
- this method can only be used in a laboratory.

4. Ion chromatography

This method consists of liquid chromatography with separation on an ion exchange resin followed by various types of detection (conductimetry, amperometry, UV spectrophotometry, fluorescence). A liquid sample is injected into an analytical column in a flow of eluant allowing the migration of the ionic species which is a specific function of their individual affinity function of their with the resin. The column separates the different ions according to their retention times. The time of the observed peaks is compared with those of a standard mixture (the height or the surface of the peaks allows a quantitative measurement. The integrator makes an automatic measurement.

Advantages:

- study of the metal and alkaline earth cations using the detector
- study of cyanide, sulphide, iodide, and bromide with the amperometric detector.

Disadvantage:

- this method can only be used in a laboratory.

5. Basic (or spot) techniques

All of these are based on the colorimetry, except pH meters. Many devices can be found on the market. They can be classified in four groups:

• **Test strips**

These are plastic strips with a pad of absorbent paper at one end which contains a reagent. When placed in a test solution, the pad changes colour, and the density is proportional to the concentration of the species to be measured. Their sensitivity and accuracy are poor, so they are only used to control process efficiency or in case of accidental pollution.

Similar strips can also be used to test for pH, either in broad or narrow ranges.

• **Comparators**

A system with two beams is used. One of them passes through the sample with reagents added, and the other one is directed to a coloured scale. The coloured scale is adjusted to equal the colour of the test sample, and this gives the concentration of the element being measured.

- **Photometers**

These are an optical system isolating different wavelengths provided with interference filters. The source is polychromatic and the incidental light includes either the whole visible spectrum or a part of a band between two wavelengths. The light signal is converted into electrical current which is treated and displayed either on a galvanometer with a needle or a digital apparatus. Then the concentration can be directly read.

- **pH meters**

These can be either portable or laboratory based.

Conclusion:

The range of analytical equipment is suitable technically for the objectives of self-monitoring.

The difficulty is in the complexity of the effluents and in the need for samples that are proportional, i.e. correspond accurately to the effluent discharged.

The results are compatible, except for cyanides (which may require stabilising before transporting to verifying laboratories or if much time elapses prior to analysis).

The collection and preparation of proportional samples (including stabilisation), the complexity of the effluents, and the type and complexity of analyses requires suitably qualified and trained staff.

References:

[56, France, 2003] Reference document on the General Principles of Sampling [91, EIPPCB,]

8.5 Reference plants in Germany

Note: No data was given for Plants B or I.

8.5.1 Reference plant A

Age of the plant

20 years.

Number of employees in surface treatment

22 co-workers (18 in production, 4 in administration).

Type of plant

In-house shop.

Production units of the complete business

- foundry for plastics and zinc (pressure pouring)
- mechanical treatments (pressing and machining)
- paint shop
- plating
- assembly.

Production processes in this plating unit

Barrel plant for small articles with the following process steps:

- hot degreasing
- electrolytical degreasing
- cyanide copper plating
- black nickel plating
- half gloss-nickel plating
- chemical nickel plating.

The base materials of the treated workpieces are approximately:

- 60 % die-cast zinc
- 30 % steel
- 10 % brass and copper.

Throughput

- 54000 m²/yr of small articles, involving:
 - 5000 operation hours per year
 - 5000 to 10000 barrels/yr
 - workpieces 100000 kg/yr.

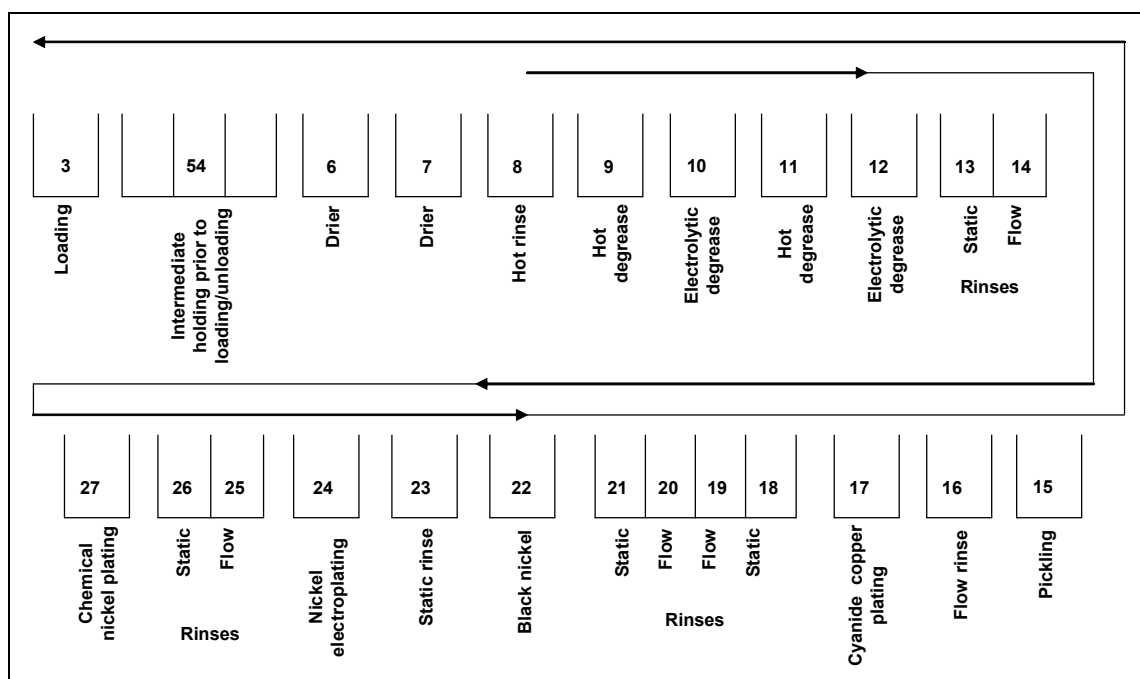

Figure 8.1: Plant A process flow diagram

Chemicals used, including trade names	Process step	Quantity or volume of bath in litres	Concentration	Annual consumption
Rivolta BRX	Hot degrease	300	50 g/l	220 kg
Bonder V358	Hot degrease	320	100 g/l	325 kg
Entfetter 2032	Electrical degrease	320	150 g/l	450 kg
Sodium cyanide Copper cyanide Additive part 3 Additive part 4 Additive part 5 Copper anodes	Cyanide copper	320	25 g/l 55 g/l (Cu+) 13.4 ml/l 6.8 ml/l n/d n/a	400 kg 300 kg 90 kg 30 kg 30 kg 900 kg
Start solution Lead salt Additive BP Additive 67 Wetting agents	Black nickel	250	140 ml/l 60 g/l 10 ml/l 5 ml/l n/d	600 kg 100 kg 400 kg 40 kg n/d
Nickel sulphate Nickel chloride Boric acid Wetting agent Brightener additive Nickel anodes	Semi-bright nickel	320	65 g/l (Ni ²⁺) 25 g/l (Cl ⁻) 40 g/l 5 ml/l 20 ml/l n/a	900 kg 400 kg 300 kg 90 kg 150 kg 500 kg
Solution C-A1 Solution C-A2 Solution C-A3 Regenerate C-A5 Solution C-A6 Regenerate C-A8 Nitric acid	Chemical nickel station 27	320	67.2 ml/l 67.2 ml/l 0.75 ml/l 18.56 l/MTO n/d pH maintenance	300 kg 150 kg 15 kg 300 kg 180 kg 230 kg 1260kg
Chemicals	Process step	Quantity/volume	Operational concentration	Annual consumption
NaOH NaOCl HCl Amidosulphonic acid Flocculating agents Lime, solid	Effluent treatment prior to discharge to municipal waste water system			20980 kg 38000 kg* 2082 kg 700 kg 540 kg 175 kg
* NaOCl consumption from 1 June 99 was only 9770 kg, since nitrite treatment was changed over to amidosulphonic acid n/d = non determined n/a = non applicable				

Table 8.7: Plant A input materials

Process step	Material	Refill amounts	Refill cycle	Analytic control cycle
Hot degrease	Rivolta BRX	4.4 kg/w	Weekly (w)	Weekly
Hot degrease	Bonder V358	6.3 kg/w	Weekly (w)	Weekly
Electrical degrease	Entfetter 2032	9 kg/w	Weekly (w)	Weekly
Cyanide copper	Sodium cyanide copper Cyanide Additive part 3 Additive part 4 Additive part 5 Copper anodes	1.6 kg/d 1.2 kg/d 360 g/d 120 g/d 120 g/d 3.6 kg/d	Daily (d)	Daily
Black nickel	Start solution Lead salt Additive BP Additive 67 Wetting agents	2.4 kg/d 400 g/d 1.2 kg/d 160 g n.b.*	Daily (d) n.b. * added routinely without analysis	Daily
Semi-bright nickel	Nickel sulphate nickel Chloride Boric acid Wetting agent Gloss additive Nickel anodes	18 kg/w 8 kg/w 6 kg/w 1.8 kg/w 3 kg/w 10 kg/w	Weekly (w)	Weekly
Chemical nickel	Solution C-A1 Solution C-A2 Solution C-A3 Regenerate C-A5 Solution C-A6 Regenerate C-A8 Nitric acid	1.2 kg/d 600 g/d 60 g/d 1.2 kg/d 720 g/d 920 g/d 5 kg/d	Daily (d)	Daily

Table 8.8: Plant A service lifetime of the feeds, cycles of monitoring and refill of chemicals

Substitution for problem materials used

Cyanide-free systems for the copper plating of die-cast zinc materials are not available.

Attempts to substitute the oxidation of cyanide in effluents by sodium hypochlorite (to avoid the AOX problem) by UV-radiation supported oxidation failed. In order to keep the quantity of NaOCl used low, the nitrite treatment was changed over to reduction with amidosulphonic acid, which resulted in a saving of approximately 50 % of the sodium hypochlorite solution quantity previously used.

Designation	Input materials	Concentration (g/l)	Temperature (°C)	Service life
Hot degrease	Rivolta BRX	50	60	1 month
Hot degrease	Bonder V358 M	100	60	1 month
Electrolytic degrease	Entfetter 2032	150	60	3 months
Cyanide	NaCN Cu	25 55	50	Rarely changed
Black nickel	Beginning solution lead salt	760	60	Rarely changed
Semi-bright nickel	Ni ²⁺ Cl ⁻ H ₃ BO ₃	65 25 40	60	Rarely changed
Chemical nickel	Ni ²⁺ reducing agent	4.7 24.4	90	2 months

Table 8.9: Plant A service life of the process baths

Measures for extending the service lifetime of solutions

The service life of nickel and copper electrolytes - with the exception of chemical nickel solutions - are practically infinite, because the drag-out is sufficiently high that the impurities do not achieve a harmful concentration. Special bath care measures are not necessary. Impurities are removed from the black nickel and electrolytic solutions by filtering in a bypass system. For the remaining feeds, no special care measures are used; the service lifetimes obtained are regarded as sufficient.

Measures for the reduction of drag-out

The barrels for this line are specifically designed to achieve better draining of the liquid in the drum. After lifting out from the bath, the barrel is turned, in order to make better draining off possible. The general dripping off times are fixed to five seconds, with the exception of the copper and nickel plating tanks, where the time is 15 seconds.

The plant runs a wide variety of programmes. As a consequence, the dripping-off time for pretreatments and rinses is limited to five seconds.

Feedback of dragged-out electrolytes

The feedback of dragged-out electrolytes takes place in different ways:

- evaporation losses of the electrolytes are made-up by topping-up from the static rinses
- pre-dipping (eco rinse) in the static rinse after the copper, black and semi-bright nickel returns drag-out to the bath. Chemical nickel electrolyte cannot be fed back meaningfully, since the simultaneous build-up of impurities would reduce the service lifetime of the solution drastically.

Evaporation systems for the rinse-water for the feedback of out-dragged electrolytes are not used in this company.

Rinsing technology

Generally, the rinsing system used is 'static rinse/flow rinse', but with only a two-stage rinsing technology, where the flow rinse is led across ion exchangers in cycle. Since the workpiece throughput is only one to two drums per hour and drag-out is only small, a very small amount of waste water results. The static rinses are renewed only weekly, and their accumulated waste water amounts to approximately 1.1 m³/week; a small amount of waste water from the eluate of the ion exchangers is added to this.

The ion exchanger plant for rinse-water of the flow rinses is operated as a central plant for all the surface treatment units of the enterprise. At present, 17 rinses are discharged in a cycle; five of them from the described copper/nickel unit. The ion exchanger plant has an output of 20 m³/h and consists of exchanger columns each containing 500 litre resin. Every seven working days the cation and of an anion exchangers are regenerated. This gives an effluent of 8 m³/week.

The static rinse after copper plating is led in a bypass across an electrolysis cell at 150 l/h, in order to recover the copper present. The service life of the rinse is increased to approximately six months, at the same time 120 kg/yr of copper are recovered electrolytically. The energy consumption for the electrolysis cell amounts to about 950 kWh yearly.

Waste water treatment

There is a central waste water treatment plant for all the production areas, so the copper/nickel plant represents only a small part of the total spectrum of waste water treated.

The nickel/ferrous-cyanide containing acid or alkaline waste waters are caught and treated separately.

The waste water treatment plant consists of two static treatment tanks of 10 m³ each. The usual treatment exists for the separate treatment of cyanide and Cr(VI).

Streams containing cyanide and nitrite are mixed afterwards with the remaining concentrates for neutralisation and heavy metal precipitation. For post treatment, the treated water is led over gravel filters and selective ion exchangers before discharge to the municipal waste water system.

The waste water streams are:

- 10 m³/week streams containing cyanide
- 1.5 m³/week streams containing nickel/ferrous
- 20 m³/week acid/alkaline streams
- 5.7 m³/week eluate ion exchange eluate on average.

Emission levels of heavy metals in waste water

Parameter	Limit values	Internal control measurements	External analysis	External analysis
Copper	0.5 mg/l	0.13 mg/l	0.63 mg/l	0.18 mg/l
Nickel	1.0 mg/l	0.13 mg/l	0.20 mg/l	0.34 mg/l
Zinc	2.0 mg/l	0.24 mg/l	0.15 mg/l	0.05 mg/l

Table 8.10: Plant A emission levels for heavy metals

With an average of 35 – 40 m³ waste water per week, and average values of 0.25 mg/l Cu, 0.25 mg/l Ni and 0.15 mg/l Zn, there is an annual heavy metal load of 440 to 500 g copper, 440 to 500 g nickel and 260 to 300 g zinc.

Waste amount

Waste is mainly seven tonnes of electroplating sludge produced yearly from the waste water treatment. Some alkaline concentrates are also externally treated. There are also small quantities of absorption and filter materials.

Type of waste	European Waste Catalogue Na	Yearly quantity	Disposal or recycling	Costs including transport
Sludges containing dangerous substances	11 01 09	7.02 t	Pyrometallurgical nickel recycling	EUR 225 per tonne
Caustic solutions	11 01 07	2.0 t	Chemico-physical treatment	EUR 450 per tonne
Absorption and filter materials with dangerous impurities	15 02 02	0.15 t	Chemico-physical treatment	EUR 420 per tonne

Table 8.11: Plant A waste quantities

The electroplating sludge from the waste water treatment is used completely as a secondary raw material in a pyrometallurgical recycling plant. Composition is shown in Table 8.12.

Electroplating sludge			
Cations	Content	Anions	Content
Calcium	55.1 g/kg	Sulphur	10.7 g/kg
Iron	37.3 g/kg	Chloride	9.1 g/kg
Nickel	49.5 g/kg		
Copper	26.9 g/kg		
Zinc	38.1 g/kg		
Titanium	1.0 g/kg		
Trace components			
Chromium	109.9 mg/kg		
Manganese	33.3 mg/kg		
Molybdenum	458.1 mg/kg		
Barium	79.7 mg/kg		
Tungsten	253.9 mg/kg		
Lead	319.3 mg/kg		

Table 8.12: Plant A metal constituents of electroplating sludge

Cost considerations

The capital outlays amounted to:

- EUR 150000 for the barrel plant
- EUR 125000 for the waste water treatment plant
- EUR 15000 for the electrolytic copper recovery from the static rinse
- EUR 4000 for a filter unit for the cleaning of the feed-waters.

Maintenance and maintenance costs amount to:

- EUR 5000 yearly for the barrel plant
- EUR 2500 yearly for the effluent treatment.

The staff expenditure for the shift operation amounts yearly to EUR 45000.

Economics of the electrolytic copper recovery plant

The total costs of the plant are calculated roughly from the following factors, where the energy costs are set at EUR 0.08/kWh:

- capital costs = 8 % EUR 600/yr
- maintenance/maintenance (portion measured) EUR 300/yr
- energy expenditure = 950 KW x DEM 0.16/kWh = EUR 76/yr
- Sum of the annual costs = EUR 976/yr

These cost savings arise from the saved quantity of water (smaller discharge of the static rinse), the saved waste production, proceeds of the recycled copper and the reduced use of neutralisation chemicals. Unit savings are:

- fresh water EUR 3/m³
- proceeds for the copper EUR 0.9/kg
- 50 % NaOH EUR 0.23/kg.

Savings per year

- saving for fresh water = $10 \text{ m}^3/\text{yr} \times \text{EUR } 3/\text{m}^3 = \text{EUR } 30/\text{yr}$
 - proceeds from copper = $90 \text{ kg}/\text{yr} \times \text{EUR } 0.9/\text{kg} = \text{EUR } 78.8/\text{yr}$
 - saved precipitation chemicals (NaOH):
 $133.3 \text{ kg}: 0.76 \text{ kg}/\text{l} \times \text{EUR } 23/\text{l} = \text{EUR } 33.5/\text{yr}$
 - saved disposal costs of the sludge:
 $0.345 \text{ t} \times \text{EUR } 275/\text{t} = \text{EUR } 95/\text{yr}$
- Sum of annual savings = EUR 237/yr

Since the yearly costs exceed annual savings, there is no economic driver for this technique. This is already known by the operator.

Estimation of inputs and outputs

For Plant A, the following figures can be estimated from the available data:

Input nickel quantity = about 1023 kg/yr, consisting of:

- nickel sulphate 900 kg/yr, according to 341.5 kg of Ni/yr
- nickel chloride 400 kg/yr, according to 181.2 kg of Ni/yr
- nickel anodes 500 kg/yr.

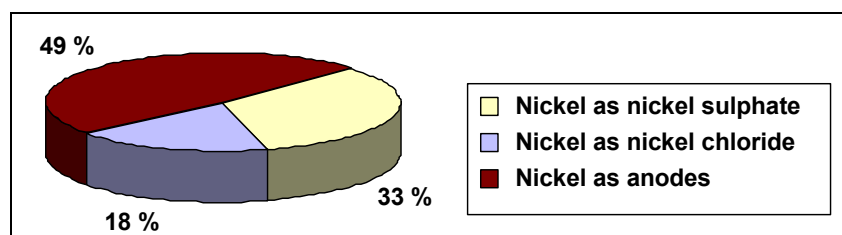

Figure 8.2: Plant A nickel inputs

Emitted nickel quantities = 347 kg/yr, 34 % of the input material used, consisting of

- 0.5 kg/yr in waste water
- 346.5 kg/yr as waste.

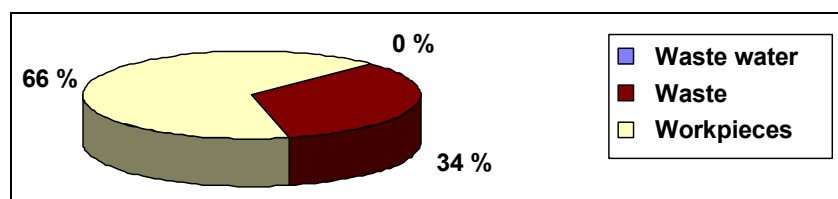

Figure 8.3: Plant A nickel outputs

Input copper quantity = 1065 kg/yr, consisting of:

- copper cyanide 300 kg/yr, equates to 165 kg of Cu/yr
- copper anodes 900 kg/yr.

Emitted copper quantities = approximately 189 kg/yr, equates to 18 % of the material used, consisting of:

- 0.5 kg/yr in waste water
- 188.3 kg/yr in wastes.

As all the waste containing metal is recycled in metallurgical plants, the overall losses of metals are minimised. The only complete losses from the system are those emissions in the waste water and inefficiencies in the metals smelters which may be 30 %.

8.5.2 Reference plant C

Age of the plant

No data

Type of plant

In-house shop

Number of employees

180

Production units of the business

- foundry for plastics (injection moulding) and zinc (pressure pouring)
- mechanical treatment
- galvanizing
- assembly.

Production processes in the plating unit

- copper plating
- nickel plating
- chromium plating.

with all necessary pre- and post- treatment processes

Basic material

Zinc die casting and brass

Throughput

No data available

Volume of the treatment vats

- | | |
|------------------------------|----------------------|
| • metal stripping | 2.2 m ³ |
| • pre- degreasing | 3.2 m ³ |
| • degreasing | 4.8 m ³ |
| • electrolytic degreasing | 7.2 m ³ |
| • acid copper plating vat I | 5.9 m ³ |
| • acid copper plating vat II | 14.1 m ³ |
| • nickel plating | 13 m ³ |
| • chromium plating | 3.8 m ³ . |

The sum of the process baths is larger than 30 m³; the plant is therefore subject to approval under the IPPC Directive

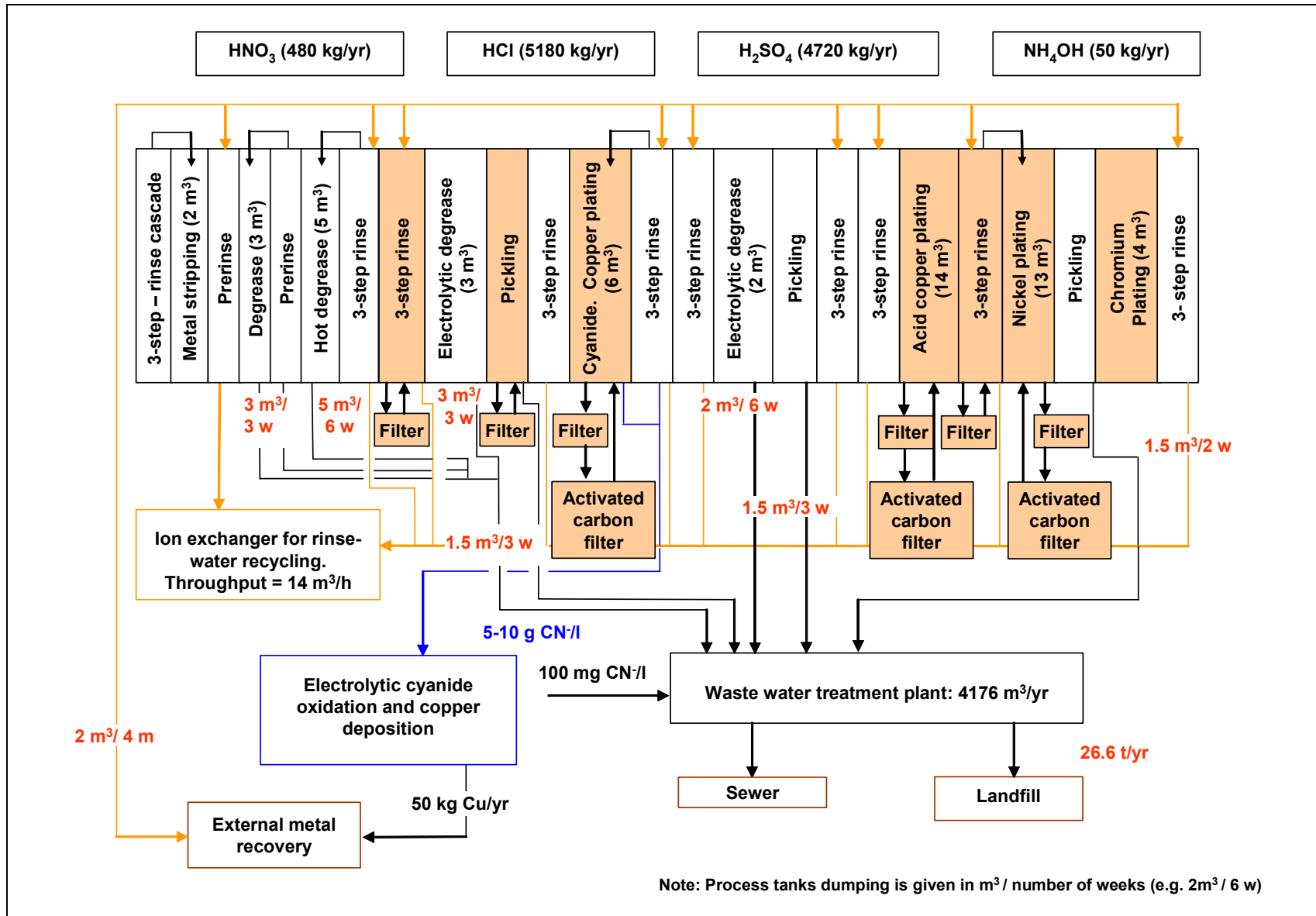

Figure 8.4: Plant C process flow diagram

Substitution for problem materials used

Methanol was used as a brightener with the acid copper plating bath, but was replaced due to its toxicity.

Cyanides cannot be replaced when copper plating die-cast zinc parts.

The main part of the cyanide in the waste water is electrolytically oxidised, which minimises the use of the sodium hypochlorite. However, sodium hypochlorite cannot be replaced totally, and is still used with the rinse-water containing cyanide.

Measures for the reduction of drag out

Low concentrations of the process solutions are generally used. The draining times are up to 10 seconds, which achieves relatively good draining off and thus smaller losses result.

Measures for extending the service lifetime of solutions

Pickling, copper and nickel electrolytes are filtered, as are the two prerinses, whose service life could be increased thereby to the six-fold.

The copper electrolytes are treated with activated charcoal, which achieves an almost unlimited service.

Rinsing technology

The rinsing technology is generally three step cascade. In addition the rinse-waters are recycled via ion exchangers.

Feedback of dragged-out electrolytes

There is automated feedback of rinse-water into the process solutions to a pre-determined working level. This is with all degreasing solutions and the cyanide copper, satin nickel and chromium electrolytes.

A pre-dip (eco rinse type) is used with the bright nickel electrolyte, achieving about 50 % recovery.

Plant Data

- plant throughput: 25000 racks/yr
40000 to 50000 m² treated surface/yr
- anode material: nickel (no data)
copper 750 kg/yr
- chromic acid: 2400 kg/yr, which is 1248 kg Cr/yr.

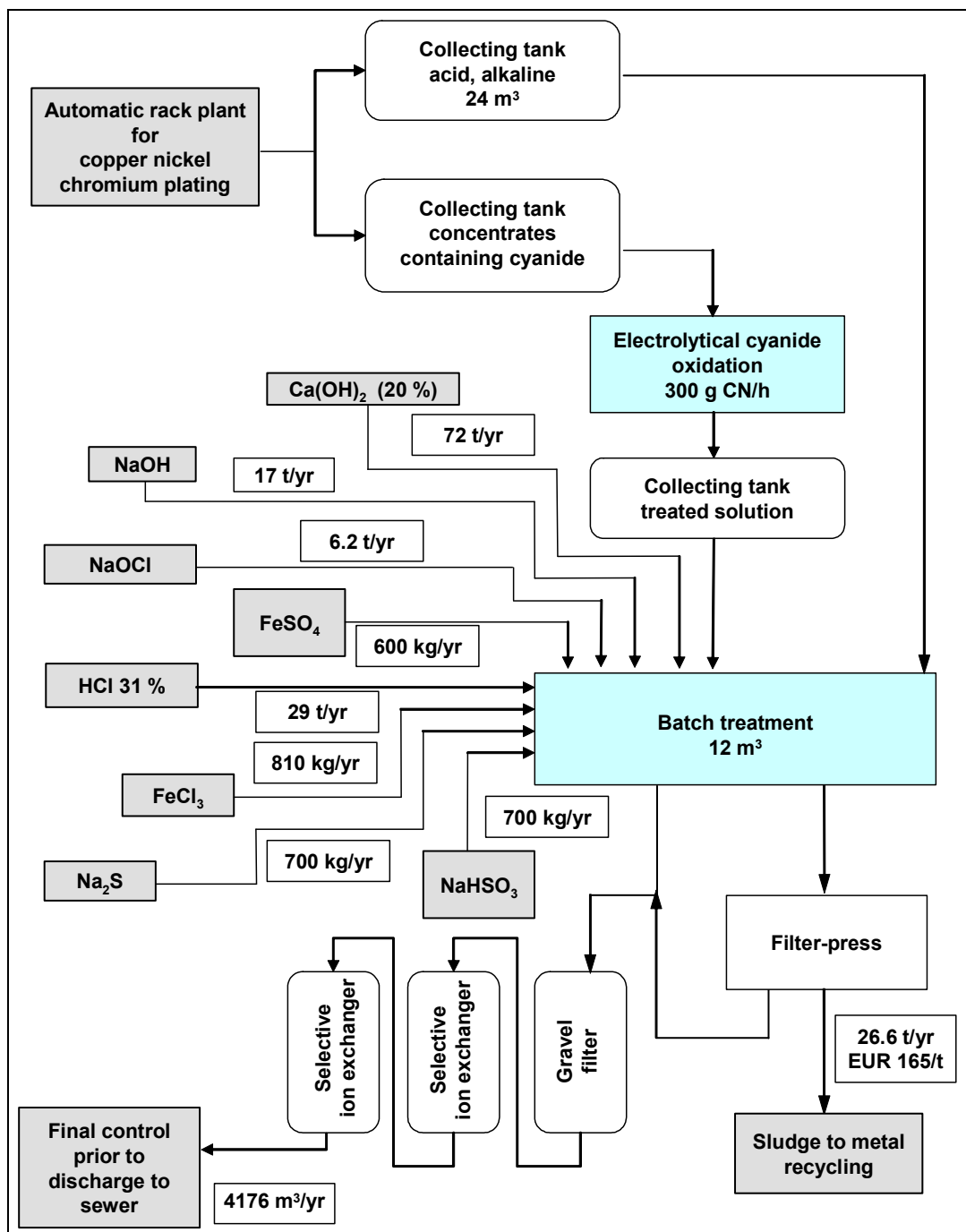

Figure 8.5: Plant C waste water treatment plant flow diagram

The electroplating sludge has the following composition

- dry residue approximately 50 %
- copper 4.3 g/kg
- nickel 14.8 g/kg
- iron 17.5 g/kg
- zinc 2.2 g/kg
- calcium 112.5 g/kg
- chromium 44.5 g/kg

The concentrations of the heavy metals in the waste water effluent are

- copper 0.25 mg/l
- nickel 0.2 mg/l
- chromium 0.10 mg/l
- iron 1.8 mg/l.

Metal balances

a) Copper

- input copper quantity (anode material) 750 kg/yr
- copper discharge with the waste water treatment sludge 114 kg/yr
- copper discharge with the waste water 1.04 kg/yr.

About 15.3 % of the copper is lost from the process (84.7 % usage); 0.14 % of the total is lost on the waste water.

b) Nickel

- input nickel quantity (anode material) 10815 kg/yr
- nickel discharge with the waste water treatment sludge 394 kg/yr
- nickel discharge in the waste water 0.83 kg/yr.

Of the input nickel quantities (10815 kg), 703.1 kg are emitted yearly mainly as waste. This corresponds to 96.3 % use. The nickel portion emitted with the waste water amounts to <0.01 % of the input quantity.

c) Chromium

- input chromium quantity (as H₂CrO₄) 1248 kg/yr
- chrome discharge with the waste water treatment sludge 336 kg/yr
- chrome discharge with the waste water 0.4 kg/yr.

About 27 % of the input chromium quantity is emitted (again, mainly as waste), with 73 % used. The waste water route contributes 0.032 %.

Overall

The plating sludge is entirely used as secondary raw material in metallurgical processes. The loss of input metals from the overall system is <1 % (actually 0.018 %), and this is as emissions in the waste water. However, this does not take into the account the efficiency of metals recovery in the smelters, etc. which may be as low as 70 %.

8.5.3 Reference Plant D

Age of the plant

No data

Type of plant

In house shop

Number of employees

No data

Production programme of the entire enterprise:

- mechanical work
- plating and
- assembly, including packing and dispatch.

Production programme of this plating unit (plant D):

- copper plating
- nickel plating
- chemical nickel plating
- chromium plating
- silver and gold plating.

Basic material

Steel and brass parts

Throughput

3000 tonnes steel and non-ferrous metals

Volume of the treatment vats

- | | |
|--------------------------|---------------------|
| • metal stripping | 16 m ³ |
| • soak degreasing | 3.6 m ³ |
| • electrolyte degreasing | 11.2 m ³ |
| • cyanide copper plating | 4 m ³ |
| • acid copper plating | (no data) |
| • nickel plating | 15 m ³ |
| • chromium plating | 4.4 m ³ |
| • silver plating | 12 m ³ . |

Input of material

No data available.

Substitution for problem materials used

Cyanides are partly substituted in degreasing solutions. The substitution for the cyanide copper plating resulted in severe quality problems and has therefore been withdrawn. As an alternative to the sodium hypochlorite oxidation of cyanide, carot and UV-ray-supported electrolytic oxidation were trialled extensively with no success.

Measures for the reduction of drag-out

The concentration of the chromic acid in the chromium plating unit was lowered to 150 g/l, from which a substantial decrease of dragged-out electrolyte results.

In-house building of racks and intensive maintenance of the racks led to a significant reduction of the drag out.

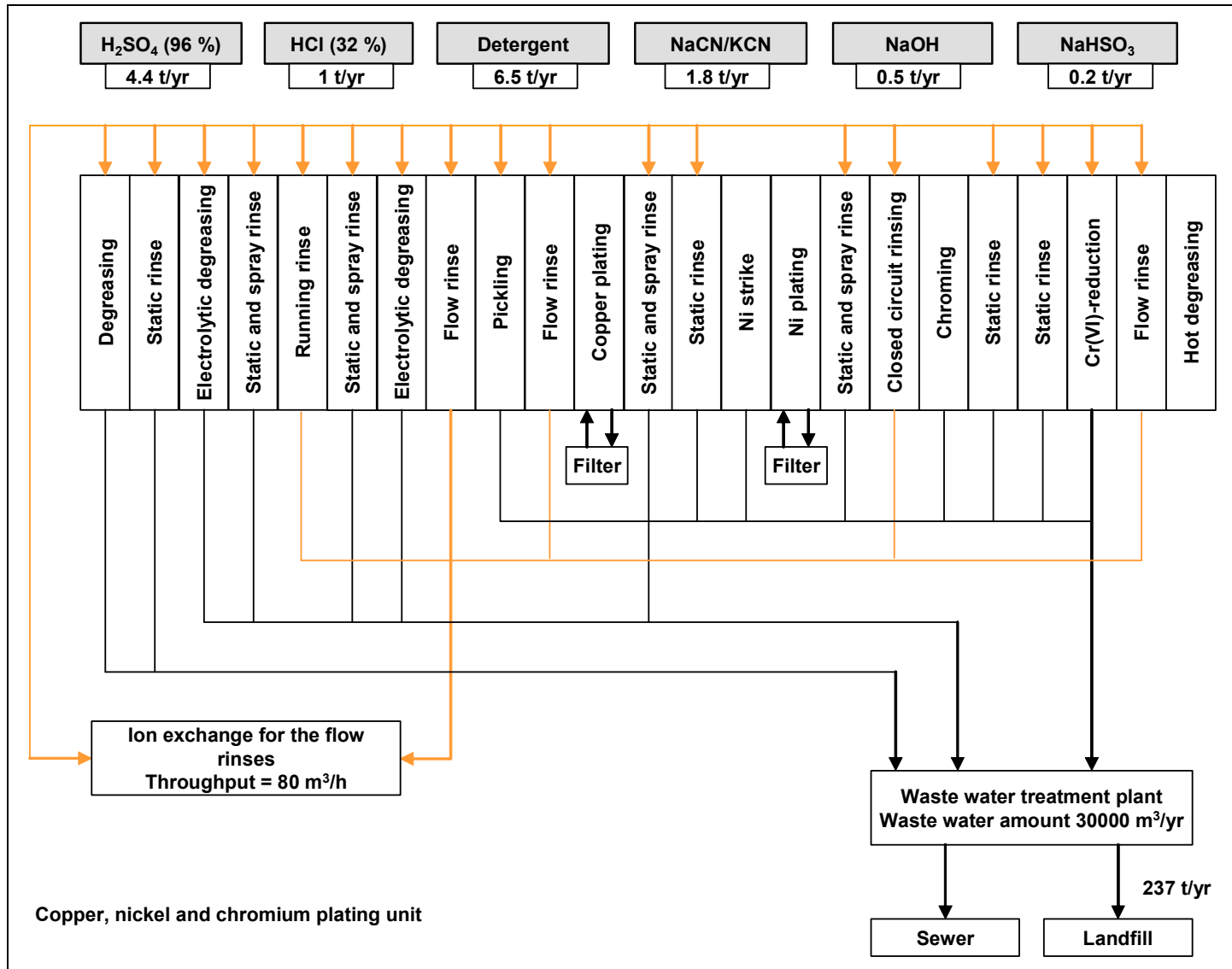

Figure 8.6: Plant D process flow diagram

Measures for extending the service lifetime of solutions

Copper, nickel and silver electrolytes are filtered; silver electrolytes are treated by an additional activated carbon treatment.

Rinsing technology

The layout of the rinsing technology is generally three step cascade rinses; an exception is the rinse after pickling. The three step cascade rinses are realised by either two static rinses or one static rinse in combination with a spray rinse, followed by a final flow rinse which is regenerated continuously by ion exchangers.

Feedback of dragged-out electrolytes

A feedback of rinse-water from the first static rinse to the process tanks is done at all nickel plating units as well as the cyanide copper and the chromium plating units.

Waste water treatment

See Figure 8.7. By employment of a so-called tubular rotorfiltration for the dewatering of the sludge generated with the neutralisation of the waste water, the addition of flocculation chemicals (iron salts, lime milk, flocculants) could be reduced drastically.

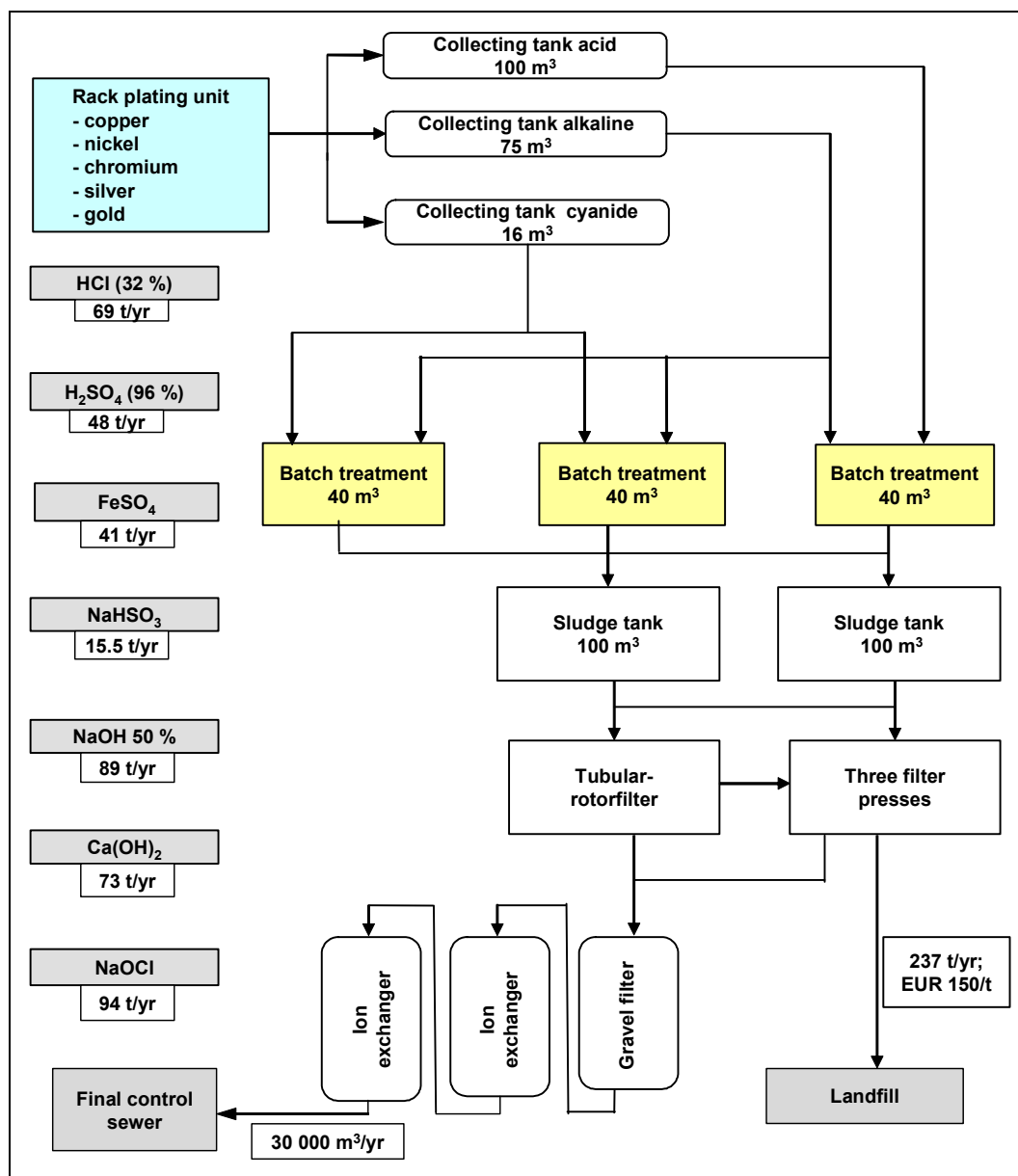

Figure 8.7: Plant D waste water treatment flow diagram

Characteristic data of the plant

Because of the large product variety and the steadily changing number of product types, the indication of metal on the treated surface is not possible.

The sludge analysis results in the following values (analysis of the original sample):

- dry residue approximately 48 %
- copper 0.21 g/kg
- nickel 1.4 g/kg
- zinc 0.09 g/kg
- chromium 0.13 g/kg
- hydrocarbons 3.7 g/kg.

The concentrations of the heavy metals in the waste water are

- copper <0.1 mg/l
- nickel <0.1 mg/l
- chromium <0.1 mg/l
- iron 0.5 mg/l.

Emission loads for heavy metals are given in Table 8.13:

Metal	Emission	
	In waste water	In waste
Copper	<30 kg/yr	50 kg/yr
Nickel	<30 kg/yr	332 kg/yr
Chromium	<30 kg/yr	31 kg/yr

Table 8.13: Plant D metals losses to waste water and waste

8.5.4 Reference Plant E**Age of the plant**

20 years; last modernisation was more than 7 years ago.

Type of plant

In-house shop.

Production programme of the entire enterprise

- zinc plating and chromate finishing of steel parts
- copper plating, nickel plating and tinning of steel parts
- copper plating, nickel plating and tinning of non-ferrous metal parts
- silver plating of non-ferrous metal parts.

Production programme of the plating unit (Plant E)

This is an electroplating unit which consists of the following process steps: hot degreasing, pickling, electrolytically degreasing, cyanide electroplating, lightening, blue chromating.

Throughput

63000 m²/yr in 2400 working hours per year.

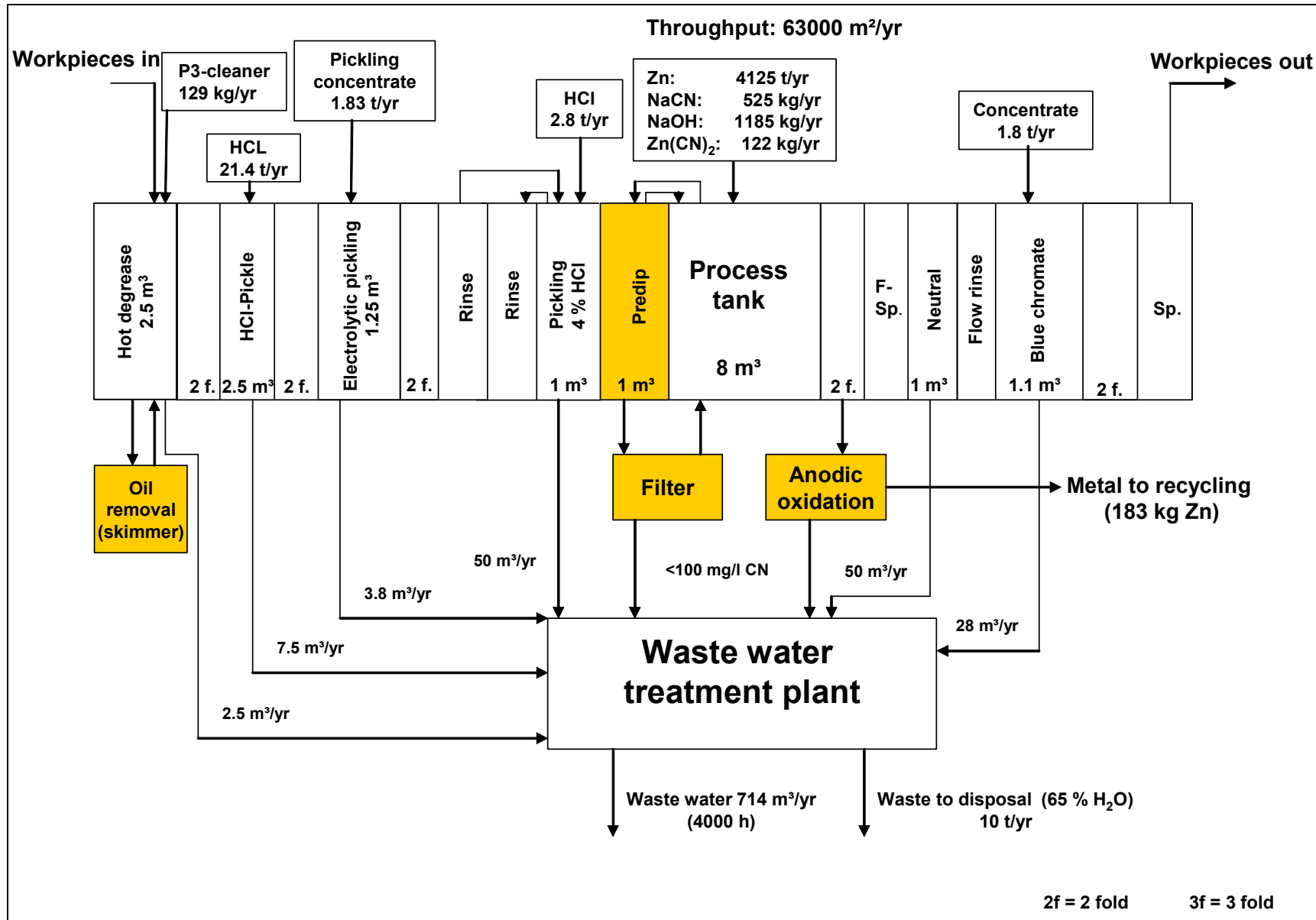

Figure 8.8: Plant E process flow diagram

Chemicals used including brand names	Process step	Quantity (litres)	Concentration used	Annual consumption (kg)	Annual consumption in EUR
P 3 cleaner	Hot degreasing	2500	50 g/l	192	480
Hydrochloric acid, tensides	Pickle:	2500	250 g/l 25 g/l	21354	3203
Non-acid	Electrical degreasing	1250	130 g/l	1796	4040
Zinc anodes zinc cyanide NaCN NaOH	Zinc electrolyte	8000	Zn 20 g/l 40 g/l 85 g/l	4036 150 525 1415	5400 600 920 481
Nitric acid	Clarification	1000	29 g/l	1000	250
Tridur Zn blue	Blue chromate finishing	1100	70 ml/l	2370	7110
Sum:					22484
Caustic soda 50 %	Effluent treatment system This plant treats 23.5 % of the total waste water	--	--	120300	36090
Lime				19000	2850
Hydrochloric acid 30 %				40000	7000
Sodium hypochlorite				19000	5130
Ferrous sulphate				3000	450
Sum total					
Proportional	23.5 % of the total system				12107

Table 8.14: Plant E input materials

Substitution for problem materials used

Due to the current safe design and operation of the plant, no substitution of input materials, e.g. cyanides, is planned at present.

Material	Refill cycle	Analytic control cycle	Service lifetime
P 3 cleaners	12/year	2/month	52 weeks
Hydrochloric acid 30 %	20/year	1/week	17 weeks
Non-acid	3/day	1/week	17 weeks
Zn NaCN NaOH	1/week	1/week	infinitely
Nitric acid	1/day	1/day	1 week
Tridur Zn-blue	continuously	1/week	2 weeks

Table 8.15: Plant E service life of the solutions – cycle of the monitoring and refill of chemicals

Measures for extending the service lifetime of solutions

The service life of the zinc electrolyte is practically infinite, as the drag out is sufficiently high that the impurities do not achieve a concentration that deteriorates plating quality. Special bath care measures are not then necessary.

An oil separator (skimmer) is used to remove fats, oils and other pollutants from the hot degreasing solutions.

The chromating solution is not regenerated.

Measures for the reduction of drag out

Spray rinse over hot and electrolytic degrease tanks.

Feedback of dragged-out electrolytes

- partial direct feedback of contents of the static rinse into the process tanks
- pre-dip in the static rinse of the zinc plating stage; resulting to a 50 % feedback of dragged out electrolytes.

Rinsing technology

See flow diagram Figure 8.8.

Waste water treatment

See flow diagram Figure 8.9.

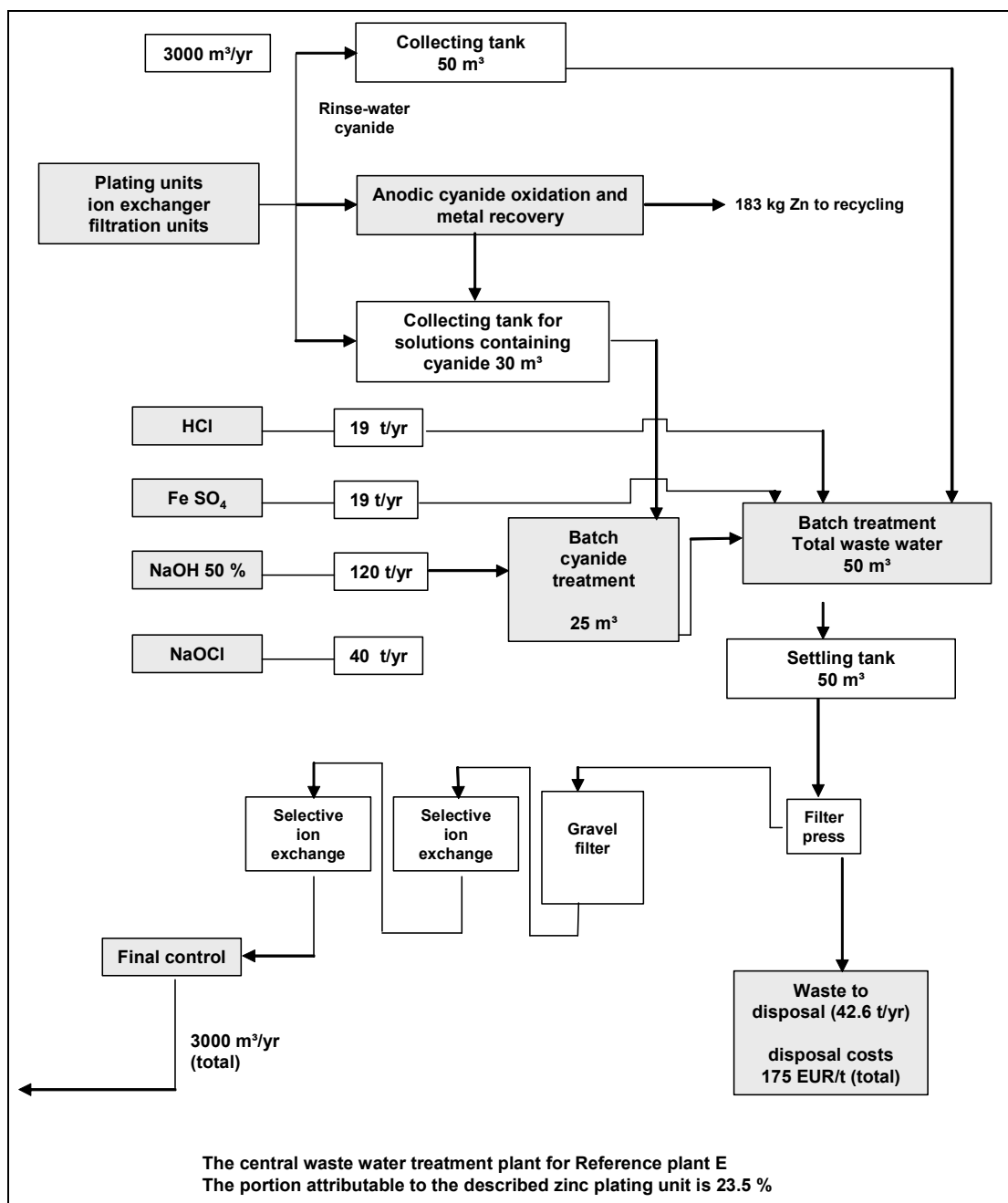

Figure 8.9: Plant E waste water treatment plant flow diagram

The waste water of this plating unit is treated together with the waste water from other surface treating unit of the enterprise. The fraction amounts to 23.5 % of the total waste water of the whole plant.

Special techniques in waste water treatment - Electrolysis cell for the oxidation of cyanide and the recycling of zinc and copper from rinse-waters

An electrolytic cell is used for the treatment of the rinse-waters containing cyanide coming from the copper and zinc plating units, in order to oxidise the cyanide-ion (at the anode) and to separate the metals (at the cathode). This greatly reduces the use of sodium hypochlorite and therefore the formation of AOX. Anodic oxidation of the solutions containing cyanide achieves a cyanide concentration of less than 100 mg/l.

At the cathode 331 kg copper and 183 kg of zinc are separated; at the anode 571 kg of cyanide is oxidised.

The energy consumption for cyanide oxidation and metal reduction is 6753 kWh/yr. The treatment cost is EUR 0.9/kg cyanide oxidised, assuming a price of EUR 0.075/kWh (the metal utilisation is not considered here). The average concentrations of the cyanide input stream is 3.7 g/l and 0.018 g/l in the output stream. The emission levels achieved are shown in Table 8.16

Parameter	Emission concentrations mg/l		
	Limit values	Internal analysis	External analysis
Chromium	0.5	0.2 – 0.4	0.3
Cyanide	0.2	<0.2	0.1
Zinc	2.0	0.8 – 1.2	1.1

Table 8.16: Plant E waste water emission values for heavy metals

Loads of heavy metals

With a water usage of 3036 m³ per year and metal concentrations of 1 mg/l Zn and 0.3 mg/l Cr respectively, there is an annual heavy metal load of 3036 g zinc and 910 g chromium released to the sewer.

Waste produced

The quantity of waste from the described plating unit is 10 t/yr (water content 65 %).

Type of refuse	European waste catalogue number	Yearly proportional quantity	Utilisation/ disposal type	Costs (including transport)
Cyanide-free waste, containing chromium	11 01 09	10 t	Landfill	EUR 175 per tonne

Table 8.17: Plant E waste produced

Refuse disposal

The waste is disposed of to a special landfill. It has a zinc content of 40 g/kg dry weight.

Costs considerations

The annual costs of the entire galvanic shop amounts to EUR 2.3 million as:

- 55 % fixed costs of plant depreciation, building, personnel reallocation
- 35 % variable costs (materials for processes, waste water, maintenance, energy)
- 10 % direct labour costs: four persons for serving the plating units; related to the zinc portion of the zinc drum plant 0.67 man-years are calculated with costs per worker of EUR 56500/yr.

Personnel expenditure for maintenance of the entire plants and the electrolytes (1.2 persons) as well as operation and maintenance of the effluent treatment (1 person) is contained in the fixed costs.

The capital outlays for the anodic oxidation cell amounted to EUR 30000 (at 1993 costs). For a 10 year write-off period at EUR 3000/yr, the portion of the rinses containing zinc amounts to 18 %, so the proportional annual amortisation costs for this equipment is EUR 501.

The cost of electricity is set at EUR 0.075/kWh. The costs of fresh water (drinking water) from public supply amount to EUR 1/m³ and for the discharge of waste water into the local municipal sewerage system EUR 1.50/m³.

The running costs for Plant E calculated per m² are shown in Table 8.18

	Specific costs EUR/m ²
Plating process chemicals	0.28 (with anodes 0.35)
Chemicals for waste water treatment	0.19
Electricity for anodic oxidation	0.0015
Water purchase	0.005
Waste water	0.0125
Waste for removal	0.03
Manpower for plant operation	0.61
Manpower for maintenance	0.36

Table 8.18: Plant E unit costs per m²

Estimated metal loss/efficiency

For reference Plant E, the following typical figures can be derived from the available data:

- zinc used on workpieces = 80.6 %
- total zinc input = 4036 kg/yr, consisting of zinc metal 99.95 % Zn
- zinc lost from the process line = 786 kg/yr, which is 19.4 % of the material used, consisting of:
 - 3 kg/yr to waste water (<0.1 %)
 - 600 kg/yr over the waste to removal (14.9 %)
 - 183 kg/yr metal recuperated by electrolysis (4.5 %).

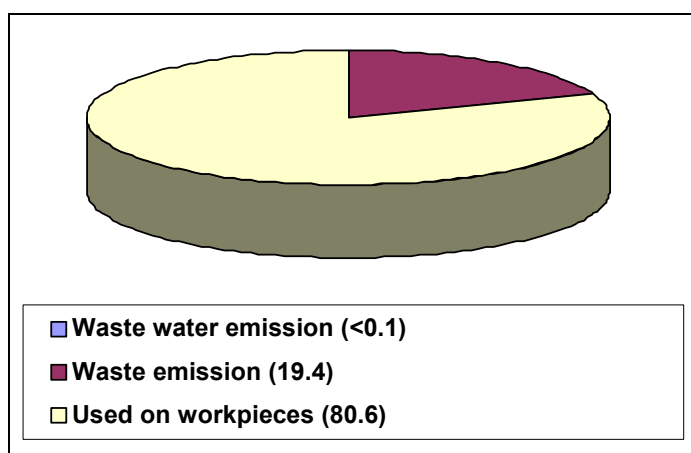

Figure 8.10: Plant E zinc emissions

8.5.5 Reference Plant F

Age of the plant

5 years

Type of plant

Job shop

Production programme of the entire enterprise

- plating and chromate finishing of steel parts
- copper plating, nickel plating and tin plating of steel parts
- copper plating, nickel plating and tin plating of non-ferrous metal parts
- silver plating of non-ferrous metal parts
- zinc plating and chromating of steel parts.

Production programme of the plating unit described (plant F)

Zinc rack unit including hot soak degreasing, pickling, electrolytically degreasing, plating, blue chromating, yellow chromating, black chromating.

Throughput

66000 m² in 5500 working hours per year

Input materials

Chemicals used for production	Process step	Annual consumption	Annual costs in EUR
Neutral cleaner	Hot soak degreasing	500 kg	5000
Sulphuric acid Tenside	Pickle	1300 kg 150 l	2500
Slotoclean	Electrical degreasing	2000 kg	3000
Hydrochloric acid 30 %	Pickle	1250 kg	400
Zinc anodes		10000 kg	13000
Zinc chloride	Zinc electrolyte	0	0
Potassium chloride		2500 kg	850
Boric acid		300 kg	315
Basic and gloss additive		2500 l	7500
Chromium trioxide ammonium chloride sodium sulphate sodium chloride	Yellow chromate finishing	100 kg	250
Metapas F	Black chromate	800 kg	3000
Immonox 3	Blue chromate	400 kg	800
Sum:			36615

Table 8.19: Plant F input materials

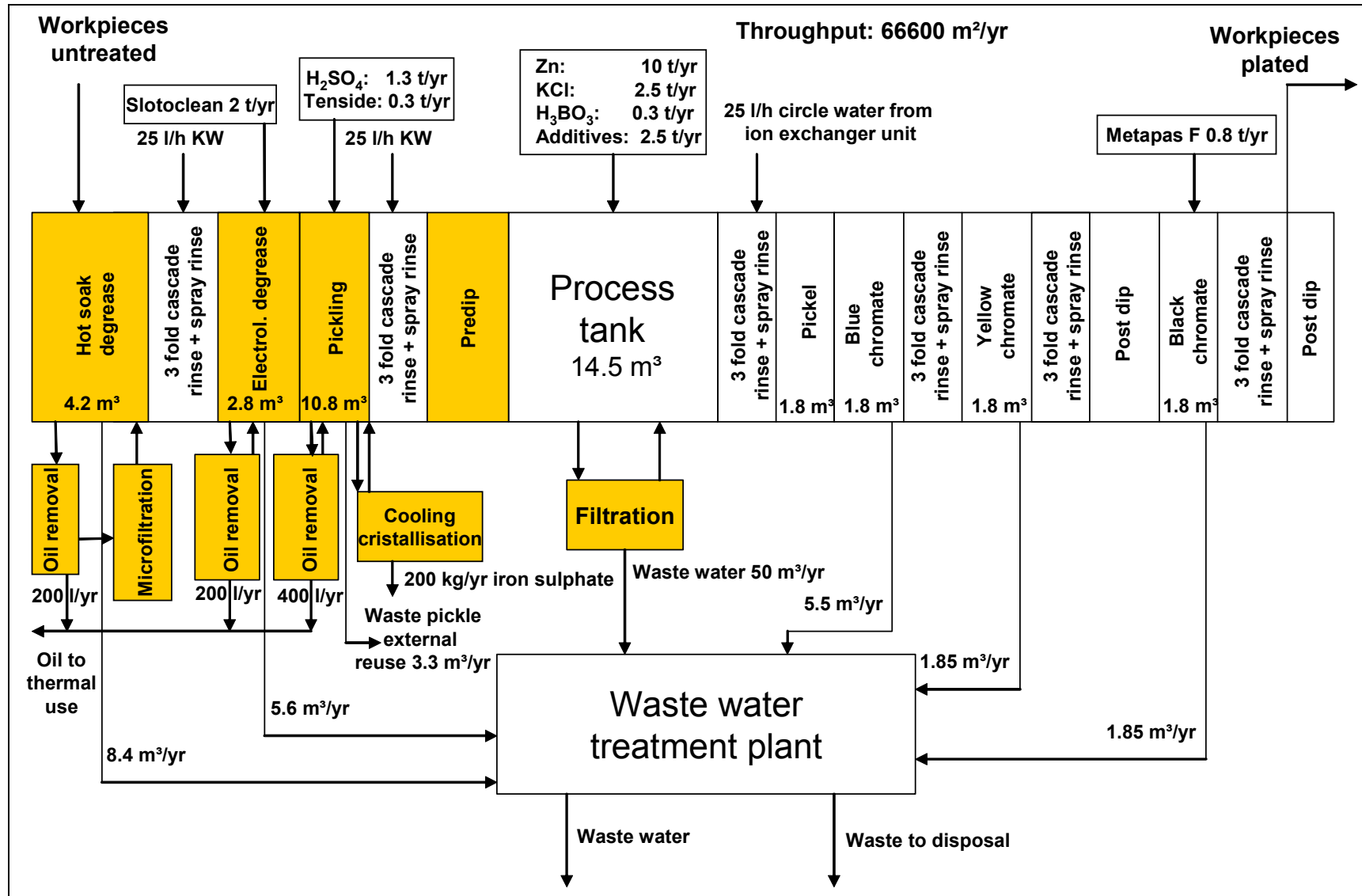

Figure 8.11: Plant F process flow diagram

Chemicals used for waste water treatment *	Process step	Annual Consumption	Annual Costs in EUR
Caustic soda solution 50 % Hydrochloric acid 30 % Sodium bisulphite Caustic sodium dithionite	Waste water treatment plant	13500 kg 17250 kg 500 kg 800 kg	2300 2900 75 650
Total cost for the total enterprise			5925
Plant F costs as 20 % of the total enterprise			1180

Table 8.20: Plant F chemicals used in waste water treatment

Substitution for problem materials used

No substitution of the materials used is currently thought necessary.

Service lifetime of the process solutions

Process step	Chemicals	Concentration	Process Temperature (°C)	Service lifetime
Hot soak degreasing	Neutral cleaner	2 % (Volume)	50 - 55	26 weeks
Pickling	Sulphuric acid Tenside	200 g/l	50 - 55	156 weeks
Electrolytic degreasing	Slotoclean	50 g/l	50 - 55	26 weeks
Zinc electrolyte	See Table 8.19	See Table 8.19	30	infinitely
Pickling	Hydrochloric acid	10 g/l	20	1 day
Yellow-chromating	Chromium chrome trioxide	7.5 g/l	20	52 weeks
Black chromating	Metapas F	100 g/l	20	52 weeks
Blue chromating	Immunox 3	40 g/l	20	16 weeks
Post dip treatment	Post dip solution	7 ml/l	20	Several weeks

Table 8.21: Plant F service lifetime of process solutions

Measures for extending the service lifetime of solutions

The zinc electrolyte is not rejected, because the drag out is sufficiently high, so that the impurities do not achieve a concentration which is harmful to quality.

The zinc electrolyte is filtered in bypass (20 m³/h).

The hot soak degreasing solutions are regenerated by a skimmer to remove grease, oil and other pollutants.

For extension of the service life, iron sulphate is separated in bypass by cooling and crystallisation from the pickling solution (H₂SO₄).

The chromate solution is not regenerated.

Measures for the reduction of drag-out

Spray rinses are installed over all hot degreasing and pickling tanks.

Feedback of dragged-out electrolytes

Feedback from the static rinse into the process tanks is widely used to balance the evaporation losses.

Pre-dip of the workpieces in the static rinse of the zinc plating unit results in a 50 % feedback of dragged out electrolytes.

Rinsing technology

Three step rinsing cascades and regeneration of the rinse-water via ion exchangers is standard.

Waste water treatment

See flow sheet Figure 8.12.

Table 8.22 shows the emission levels of heavy metals.

Parameter	Limit concentrations mg/l	Measured concentrations mg/l		
	Value	Self- monitoring	Analysis by authority	Analysis by authority
Chromium total	0.5	0.1 – 0.4	0.15	0.05
Chromium VI	0.1	<0.01	<0.01	<0.01
Zinc	2.0	0.1 - 1	0.1	0.33
Copper	0.5	0.06 - 0.1	0.1	0.05
Nickel	0.5	0.1 - 0.15	0.1	0.1
Tin	2.0	<0.4	<0.2	<0.2

Table 8.22: Plant F heavy metals in the waste water

Loads of heavy metals

With a total amount of waste water of 2500 m³ per year and metal concentrations of 0.3 mg/l Zn and 0.1 mg/l Cr, heavy metal loads of 750 g zinc and 250 g chromium result are released to the sewer yearly.

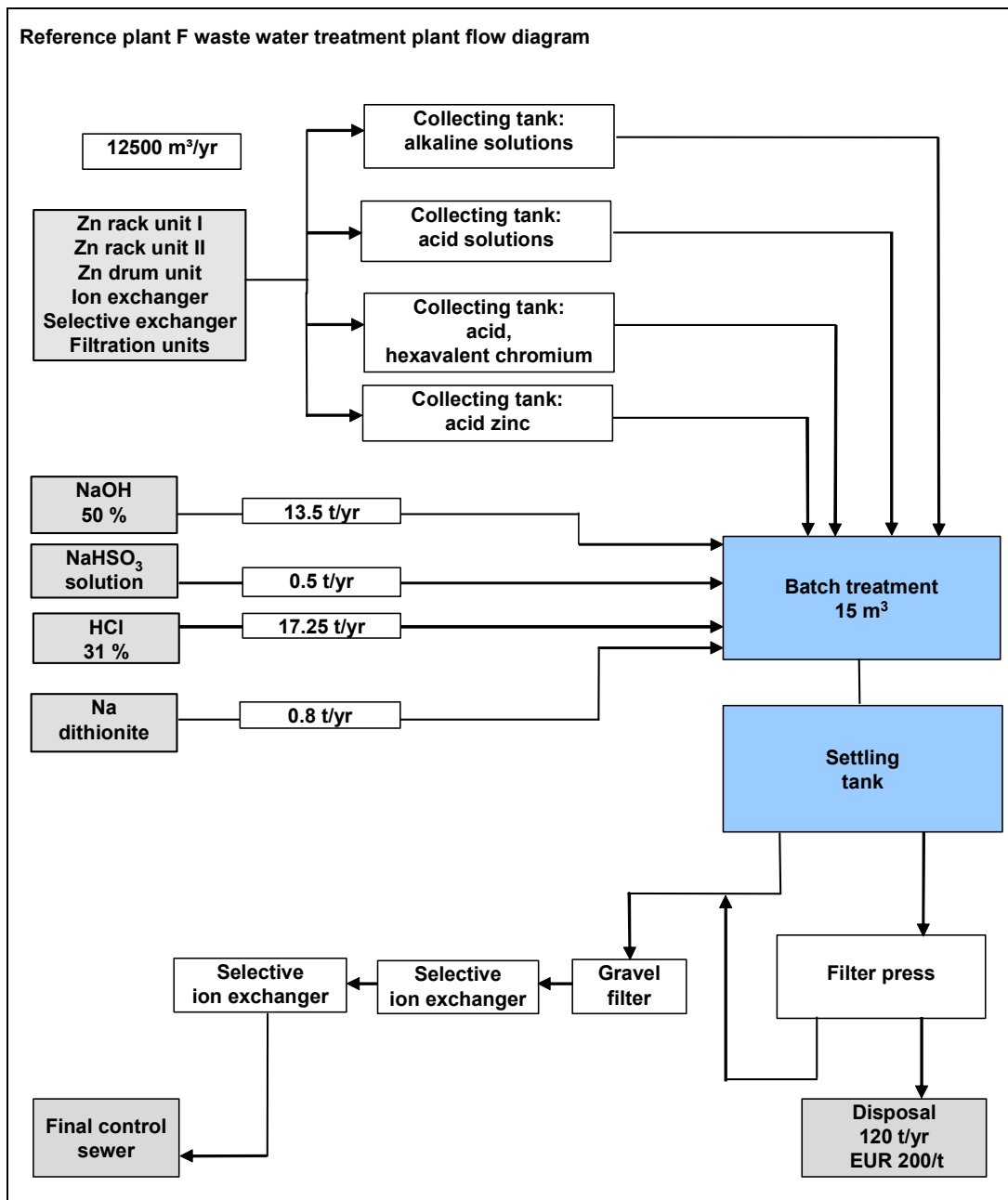

Figure 8.12: Plant F waste water treatment flow diagram

Waste quantity

The quantity of waste from the described plant amounts to 20 t/yr (water content 65 %). Details are shown in Table 8.23 and Table 8.24

	EWC No	Quantity	Manner of disposal	Disposal costs including transport
Electroplating sludge	11 01 03	20 t	Landfill	EUR 200 per tonne

Table 8.23: Plant F sludge details

Metals	Content in g/kg dry material
Zinc	210
Copper	5
Nickel	5
Chromium	20
Iron	200

Table 8.24: Plant F metal concentrations the sludge

Refuse disposal

The waste is disposed of in a hazardous waste landfill.

Air pollution control

The hot working processes tanks are equipped with an exhaust fitted on the transporter unit; the remaining process tanks have edge exhausts.

The exhaust air of 50000 m³/h is cleaned with scrubber and droplet separators. The energy costs for ventilators are EUR 800/yr.

Costs considerations

The capital outlays indicated by the operator are:

- EUR 750000 for the rack unit
- EUR 360000 for the waste water treatment plant including ion exchanger plant.

of this:

- EUR 10000 for the filtering unit for the cleaning of the zinc solution
- EUR 25000 for the de-oiling mechanisms including microfiltration
- EUR 40000 for the cooling/crystallisation unit.

Annual maintenance cost are:

Plating unit:

- EUR 50000 for material
- EUR 12500 for personnel and maintenance.

For the periphery plants (production-integrated environmental protection) the following expenditure on personnel is proportionately necessary for operation and maintenance:

- EUR 1250 filtration
- EUR 500 de-oiling systems and micro filtration
- EUR 500 cooling crystallisation
- EUR 131000 the personnel costs for the three-shift operation.

Effluent treatment and ion exchanger unit:

- EUR 19000 for material costs
- EUR 8000 for maintenance personnel.

The proportionate costs for the plating unit described amount to:

- EUR 2000 water consumed
- EUR 3000 sewage discharged
- EUR 6000 waste disposal.

Distribution of the zinc to workpieces, water and waste

The following data are typical for reference plant F:

- input zinc 10000 kg/yr, consisting of zinc semi-finished material 99.95 % Zn
- emitted zinc = 1681 kg/yr, according to 16.8 % of the material used quantity, consisting of:
 - 0.75 kg/yr in waste water
 - 1680 kg/yr in waste.

8.5.6 Reference Plant G

Age of the plant

5 years.

Type of plant

Job shop.

Number of employees

50.

Production programme of the entire enterprise

- zinc plating and chromate finishing of steel parts
- silver plating
- phosphating of steel parts
- zinc-iron alloy (zinc ferrous alloy) barrel plating.

Production programme of the plating unit described (Plant G)

Zinc-iron barrel unit (see Figure 8.13) including:

- hot soak degreasing
- pickling
- electrolytic degreasing
- zinc-iron plating (alkaline)
- yellow chromate finishing
- black chromate finishing.

Throughput

157778 m²/yr at a weight of 1703 t/yr in 6320 working hours per year

Input materials

See Table 8.25.

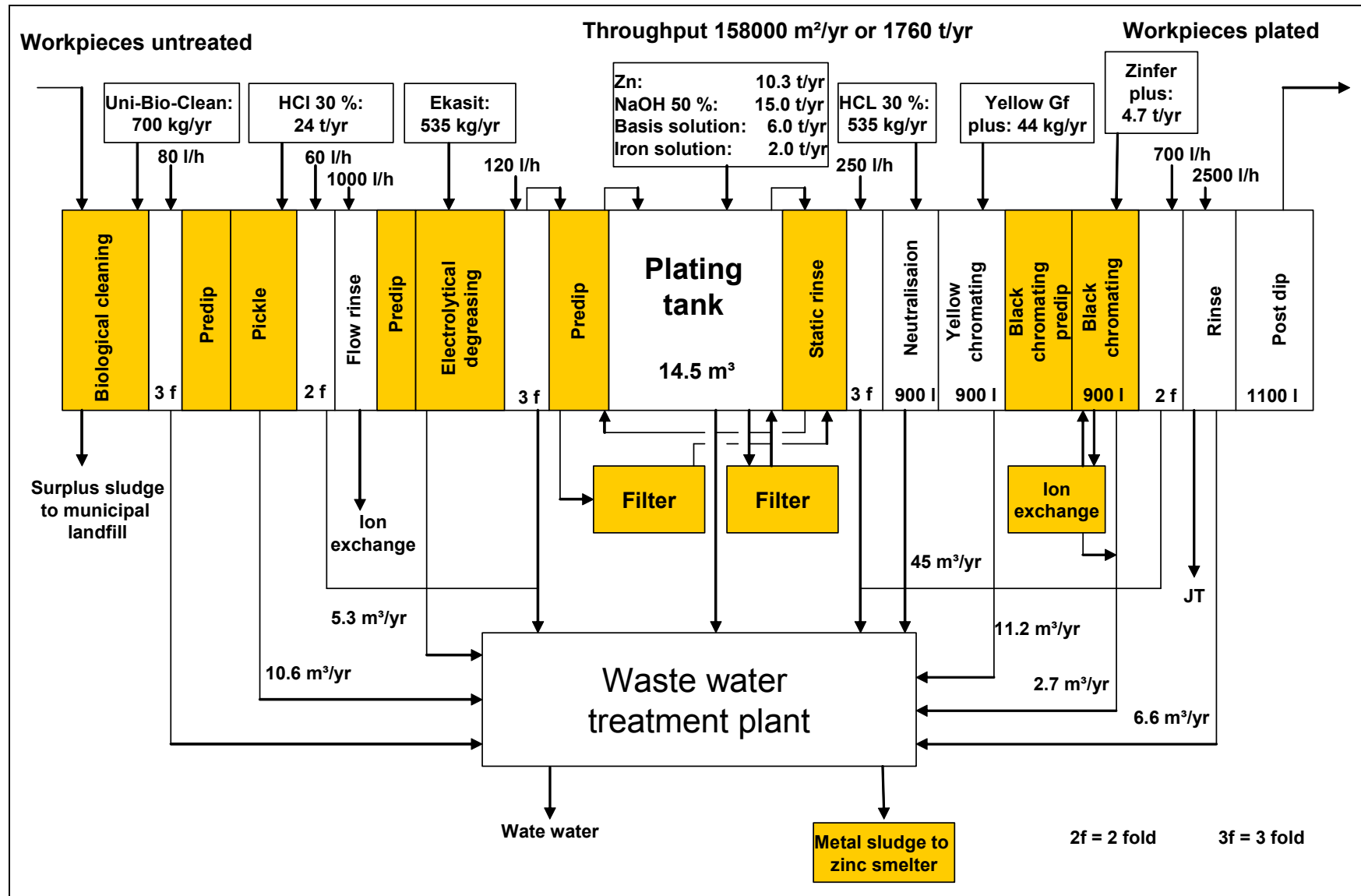

Figure 8.13: Plant G process flow diagram

Chemicals used including brand names	Process step	Concentration used	Annual consumption (kg)	Annual consumption in EUR
Uni-bio-clean	Hot soak degreasing	50 ml/l	1420	6300
Hydrochloric acid	Pickling	200 g/l	24300	4600
Acid degreasing solution		25 ml/l	574	1600
Ekasit F 15 %	Electrolytic degreasing	50 g/l	535	1300
Caustic soda solution 50 %		150 g/l	8200	1700
Zinc anodes	Zinc iron electrolyte		10276	13600
Caustic soda solution 50 %		100 – 150 g/l	15000	3400
Zinc		8 – 14 g/l		
Iron solution		70 – 200 mg/l	1968	9000
Basic solution		70 – 120 ml/l	5919	22000
Hydrochloric acid 30 %	Neutralisation	30 g/l	425	81
GF Plus	Yellow chromate finishing	40 ml/l	44	140
Zinifer plus	Black chromate finishing	80 ml/l	9900	35000
Post dip solution for zinifer plus	Post dip	7 ml/l	892	2600
Total sum for production				EUR 101321
Caustic soda solution 50 %	Chemicals used in the waste water treatment plant	-	88800	Chemical costs for the entire waste water plant: EUR 76000
Hydrochloric acid 30 %			41400	
Sodium bisulphite			16300	
Sodium dithionite			750	
Antifoaming agent			50	Proportionate chemical costs for the described unit: EUR 14000
Flocculation agent			125	
Lime			1100	

Table 8.25: Plant G input materials

Substitution for problem materials used

The materials currently used have not required substitution.

Measures for extending the service lifetime of solutions

All process solutions are regularly analytically supervised and refilled, see Table 8.26. Service lifetime is shown in Table 8.27. All electrolytes are filtered continuously. As the amount of the electrolyte drag-out is sufficiently high to keep the impurities under a process-disrupting concentration, no further measures are necessary. The biological cleaning has likewise an unlimited service lifetime: only the surplus sludge is removed. The black chromate finishing is regenerated over ion exchangers. For the remaining process solutions, no special measures are taken, since the service lifetime obtained in each case is regarded as sufficient from both ecological and economical points of view.

Process step	Material	Refill quantity kg/w	Refill cycle 3-shift operation	Analytical control
Hot soak degreasing	Ekasit 2005	--	2/w	2/w
Pickling	Hydrochloric acid 30 %	207	3/d	2/w
	Acid degreaser	10		
Electrolytic degreasing	Caustic soda solution 50 %	180	3/d	2/w
	Ekasit F15	20		
Zinc-iron electrolyte	Caustic soda solution	360	3/d	2/w
	Iron solution	40	continuously	
	Basis solution	118	continuously	
	Gloss additive	100	continuously	
Neutralisation	Hydrochloric acid 30 %	8.3	3/d	1/w
Yellow chromate finishing	AP plus	10	1/w	1/w
Black chromate finishing	Zinfer plus	150	continuously	2/w
Post dip	Zinfer plus post dip solution	6	3/d	2/w

w = weekly; d = daily

Table 8.26: Plant G cycle of monitoring and refill of chemicals

Process step	Materials	Concentration	Service lifetime
Hot soak degreasing	Ekasit 2005	50 g/l	8 weeks
Pickle	Hydrochloric acid	200 g/l	8 weeks
Electrolytic degreasing	Caustic soda 50 %	150 g/l	8 weeks
	Ekasit F 15	20 ml/l	
Zinc-iron electrolyte	See Table 8.25	See Table 8.25	Infinite
Neutralisation	Hydrochloric acid	30 %	1 week
Yellow-chromate	AP plus	40 ml/l	4 weeks
Black-chromate	Zinfer plus	80 ml/l	4 weeks
Post dip	Post dip solution	7 ml/l	8 weeks

Table 8.27: Plant G service lifetime of the process solutions

Measures for the reduction of drag-out

The drums have drillings of 5 mm, in order to achieve a better draining of the liquid. After leaving the process solution the drums are turned to get a better draining off. The draining off times amount to approximately 15 seconds. Thus the electrolyte drag out is reduced with acid solutions to approximately 11 l/h and with alkaline solutions to approximately 15 l/h (throughput of 5 drums/h).

Feedback of dragged-out electrolytes

The feedback of dragged-out electrolytes takes place by different paths:

- evaporation losses of the degreasing bath are made up from the first static rinse
- pre dip is done in the static rinses of the pickles, the electrolytic degreasing, zinc iron electrolytes and the black chromate finishing.

Rinsing technology

The layout of the rinsing technology is generally a three step cascade rinse often supplemented by an additional static rinse. Depending on the requirements of the rinsing conditions a two-step cascade with a following flow rinse with demineralised water is partly inserted.

The rinsing processes are operated with water from the public supply. Demineralised water is used for the cascade rinses after pickling.

Waste water treatment

Waste water treatment is in a central plant for all production units (see Figure 8.14), and the zinc-iron plant is only a part (25 %) of the input waste water. The resulting waste water for the selected plant (zinc/ferrous alloy separation) amounts to 3750 m³/yr. Emission levels are shown in Table 8.28.

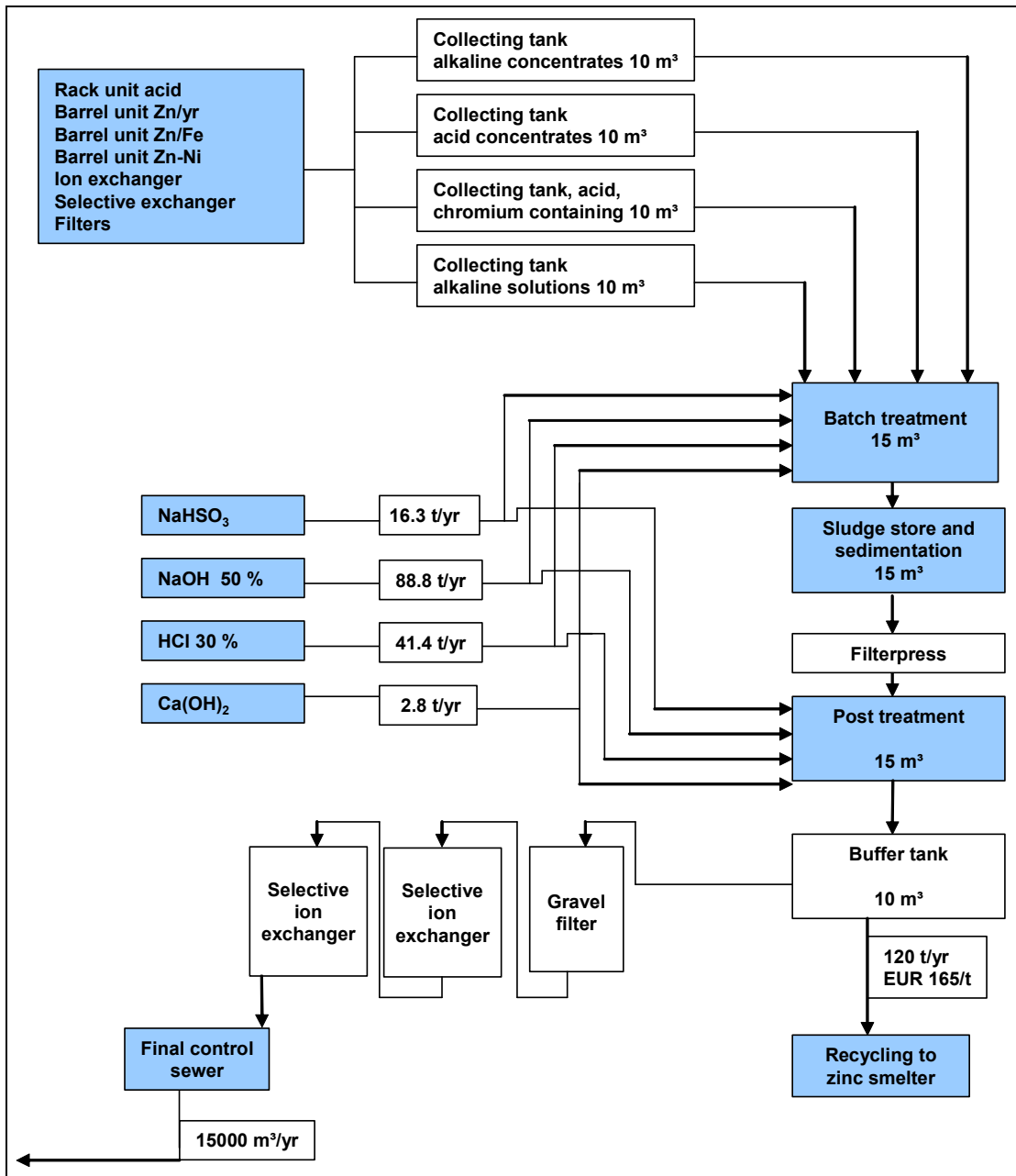

Figure 8.14: Plant G waste water treatment plant flow diagram

Parameter	Concentration values mg/l			
	Limit values	Self-control	External analysis	External analysis
Chromium total	0.5	0.4	0.3	0.3
Chromium (VI)	0.1	<0.1	<0.01	<0.01
Zinc	2.0	1.0 - 1.3	1.0	1.1

Table 8.28: Plant G waste water emission values for heavy metals

Loads of heavy metals in the waste water

Annual heavy metal load of 3900 g zinc and 1120 g chromium

Waste produced

The quantity of the electroplating sludge of the described plant amounts to 30 tonnes yearly. It contains on average 198 g/kg zinc related to the dry material (water content approximately 60 %), see Table 8.29. Due to the high zinc content the sludge is suitable for recycling in a zinc smelter. The recycling costs including transport amounts to EUR 165/t. The total loss of zinc via the waste route amounts to 2376 kg/yr.

Metal	Amount lost in sludge
Zinc	198 g/kg dry material
Lead	0.4 g/kg dry material
Cadmium	0.1 g/kg dry material
Arsenic	0.1 g/kg dry material
Iron	129 g/kg dry material
Calcium oxide	40 g/kg dry material

Table 8.29: Plant G composition of the waste water treatment sludge

Typical consumptions and costs

The costs shown shown below are summarised in Table 8.30 as costs per tonne and per m³ processed.

Personnel costs

For plating plant: about EUR 138000/yr.

Energy costs per year

- EUR 53000 plating shop
- EUR/1750 heating
- EUR 2500 waste water treatment.

Capital outlays

- EUR 200000 for the drum plant
- EUR 12500 for filtering units for the cleaning of the feeds (zinc iron)
- EUR 10000 for the de-oiling mechanism
- EUR 5000 for a recovery of the black chromate finishing
- EUR 7500 for freezing out equipment
- EUR 14000 (proportionate amount) for a biological cleaning
- EUR 300000 for the waste water treatment plant
- EUR 68000 for the cycle ion exchanger plant.

Maintenance and maintenance cost

Drum plant: EUR 16000/yr for material; EUR 16900 for personnel

Periphery plants: expenditure for personnel:

- EUR 33800/yr filtration
- EUR 22500/yr de-oiling
- EUR 33800/yr recovery of chromate finishing
- EUR 1100/yr freezing out installation
- EUR 22500/yr biological cleaning.

	EUR/tonne	EUR/m ²
Process chemicals plating (Zn-Fe):	40	0.49
Chemicals for waste water treatment	11	0.12
Energy (river + long-distance heating)	32	0.35
Water purchase	2.25	0.0025
Waste water	6.6	0.07
Waste	2.9	0.03
Investment	20	0.22
Maintenance P/M	85	0.91
Personnel for plant	80	0.85

Table 8.30: Plant G costs per tonne and per m² processed

Zinc inputs and outputs

For reference Plant G the following characteristic numbers can be calculated from the available data:

- input zinc = 10276 kg/yr, consisting of zinc metal 99.95 % Zn
- emitted zinc = 2380 kg/yr, according to 23 % of the material used, consisting of
 - 3.9 kg/yr with the waste water
 - 2376 kg/yr with the waste.

8.5.7 Reference plant H

Age of the plant

6 years.

Type of plant

In-house shop.

Number of employees

60.

Production programme of the entire enterprise

- acid zinc plating one barrel unit
- zinc-iron plating two barrel units
- zinc-nickel plating one rack unit (alkaline technique)
- zinc-nickel plating one rack unit (acid technique)
- zinc-iron plating one rack unit
- acid zinc plating one rack unit.

Production programme of the described unit

The unit is a computer-controlled zinc-nickel rack unit (alkaline technique) with variable treatment times. The process steps are: hot degreasing, pickling, electrolytically degreasing, pickling, galvanizing (zinc-nickel), transparent chromating, yellow chromating, black chromating and sealing (see Figure 8.15). The input materials are shown in Table 8.31.

Throughput

With a production time of approximately 6000 hours per year the throughput is approximately 200000 m² surface of steel workpieces which are plated and chromated or sealed. The medium capacity amounts approximately 6.3 racks or 33 m² per hour respectively. The unit operates daily in a 3-shift operation.

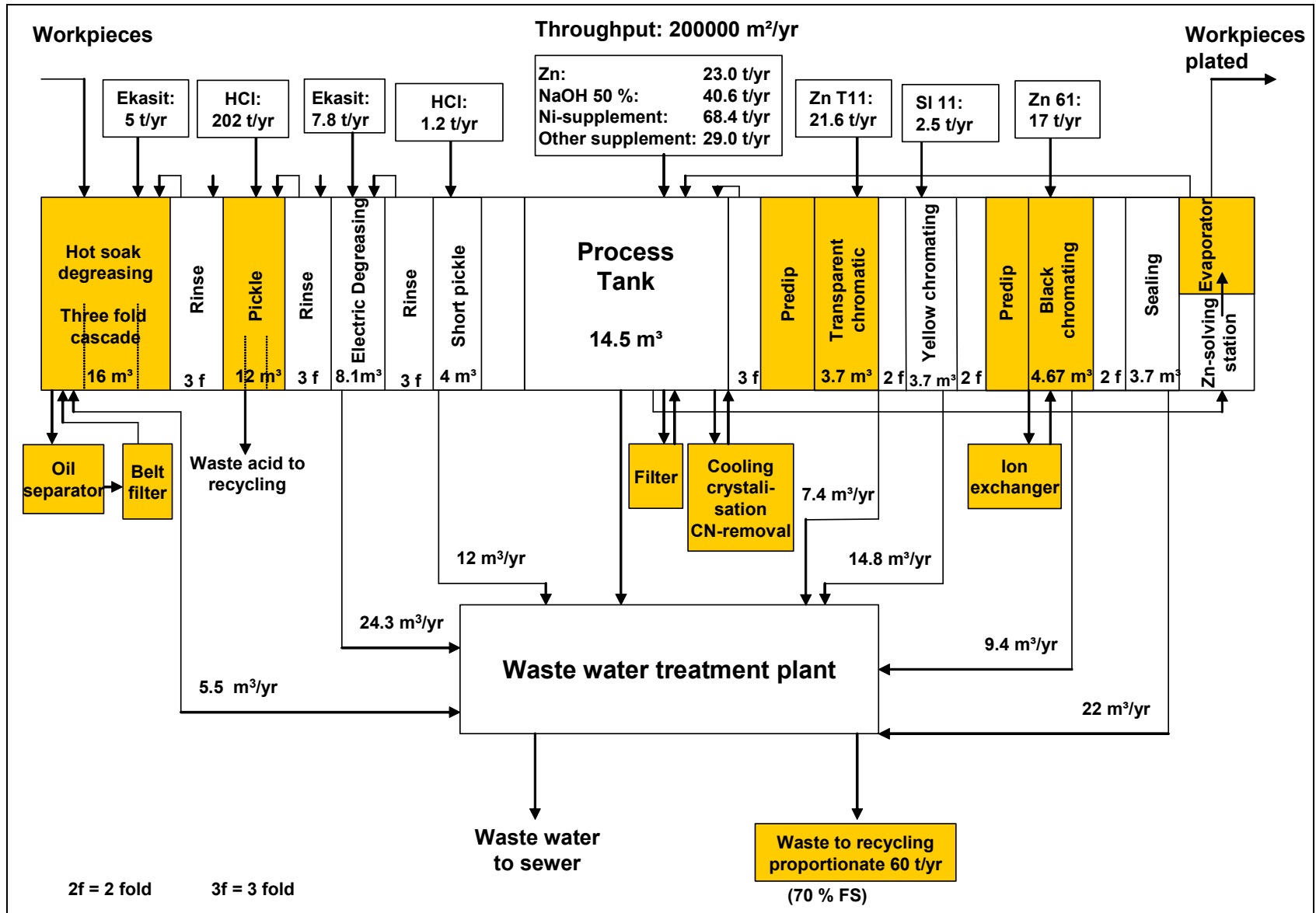

Figure 8.15: Plant H process flow diagram

(for key to input materials, see Table 8.31)

Chemicals	Process steps	Volume litres	Concentration	Annual consumption kg	Annual consumption in EUR
Degreasing agent Ekasit	Water based degreasing	16000	7 %	5000	
HCl 30 %	Pickling	12500	200 g/l	202000	
Ekasit AK	Electrolytic degreasing	8100	75 g/l	7800	
HCl 30 %	short pickling	4000	10 g/l	1250	
Zinc anodes	Zinc-nickel electrolyte			23080	
NaOH			Zn 8 g/l	40600	
EGL2		56000	Ni 3 g/l	68400	
Zn 51			120 g/l	3600	
Zn 52			160 g/l	3000	
Zn 53			25 g/l	7200	
Zn 56			50 ml/l	15200	
Slotopas SI 11	Yellow chromating	3740	70 g/l/l	2500	
Slotopas Zn 61	Black chromating	4670	120 g/l	17000	
Slotopas Zn-T11	Blue chromating	3700	60/300 ml/l	21600	
Total					EUR 580000

Table 8.31: Plant H input material

Substitution for problem materials

The introduction of Cr(III) in blue chromating is intended. This could lead to a major substitution for Cr(VI) compounds.

Measures for extending the service lifetime of solutions

The period of the analytical monitoring as well as the service life of the process solutions are indicated in Table 8.32.

The service life of the electrolytes for all plating processes is almost infinite. The drag out combined with the continuous filtration (50 m³/h) and the removal of carbonate via a cooling crystallisation unit is sufficiently high that no contaminations rise over a quality-limiting value.

The hot degreasing unit consists of three stations (one pre-degreasing and two post-degreasing steps), which are connected as cascade. The pre degreasing unit is equipped with an oil stripper and band filter to remove oil and grease, so that a bath lifetime of one year is achieved. The evaporating losses at 70 °C of 40 – 50 l/h are sufficient to be able to feed back the total rinse-water of the following three-step cascade.

A service life extension of the pickling solution could not be achieved economically, therefore the pickling solution is sold after a service life of three weeks for utilisation in a hot dip zinc coating plant.

The electrolytic degreasing has a service lifetime of four months due to very good pre-degreasing. Additional measures are not considered necessary. The evaporating losses at 50 °C in combination with a three-fold cascade are sufficient to feed back the total drag out.

The black chromate process solution is regenerated by means of ion exchange, whereby a significant extension of the service lifetime was achieved.

The yellow and transparent chromate solutions are not regenerated because of the complex chemical composition.

Process step	Input chemicals	Top up frequency (3 shift operation)	Analytical control frequency	Service lifetime
Degreasing	Ekasit	2/week	1/week	52 weeks
Pickling	HCl 30 %	2/week	1/week	3 weeks → external re-use
Electrolytic degreasing	Ekasit AK	2/week	1/week	17 weeks
Pickling	HCl 30 %	2/week	1/week	13 weeks
Plating	NaOH	Continuously	Ni 2/day	Infinite
	EGL 2		Zn online	
	Zn 51			
	Zn 52			
	Zn 53			
Yellow chromating	Slotopas SI 11	2/week	2/week	13 weeks
Black chromating	Slotopas Zn-T 11	2/week	2/week	26 weeks
Blue chromating	Slotopas Zn 61	2/week	1/week	26 weeks

Table 8.32: Plant H top up cycle and service lifetime of the process solutions

Measures for reduction of the drag out

Viscosity is reduction of the for all degreasing and the pickling solutions by adding tensides.

The draining times over the process baths are optimised, so that the dragged-out volume for each process bath does not exceed 5 l/h on an average.

Feed back of dragged-out process solutions

Rinse-water from hot pretreatment processes is fed back. This results in a large feedback of the process chemicals (the amount of rinse-water and evaporation losses are in an equilibrium)

Drip trays on the transporter collect the rest of the electrolytes (5 l/h) from the zinc nickel electrolyte which are fed back.

Pre-dipping (eco-rinse) in the static rinse of the black chromate results in a 50 % feedback of the black chromate solution.

Rinsing technology

The layout of the rinsing technology is generally a three step cascade rinse after each process step with a spray device over the rinsing liquid of the final stage.

Some processes, e.g. chromating, are usually equipped with two-step cascades in combination with a spray rinse constructed as a ring over the final stage.

A central ion exchange unit is used for several plating lines for the recycling of rinse-water.

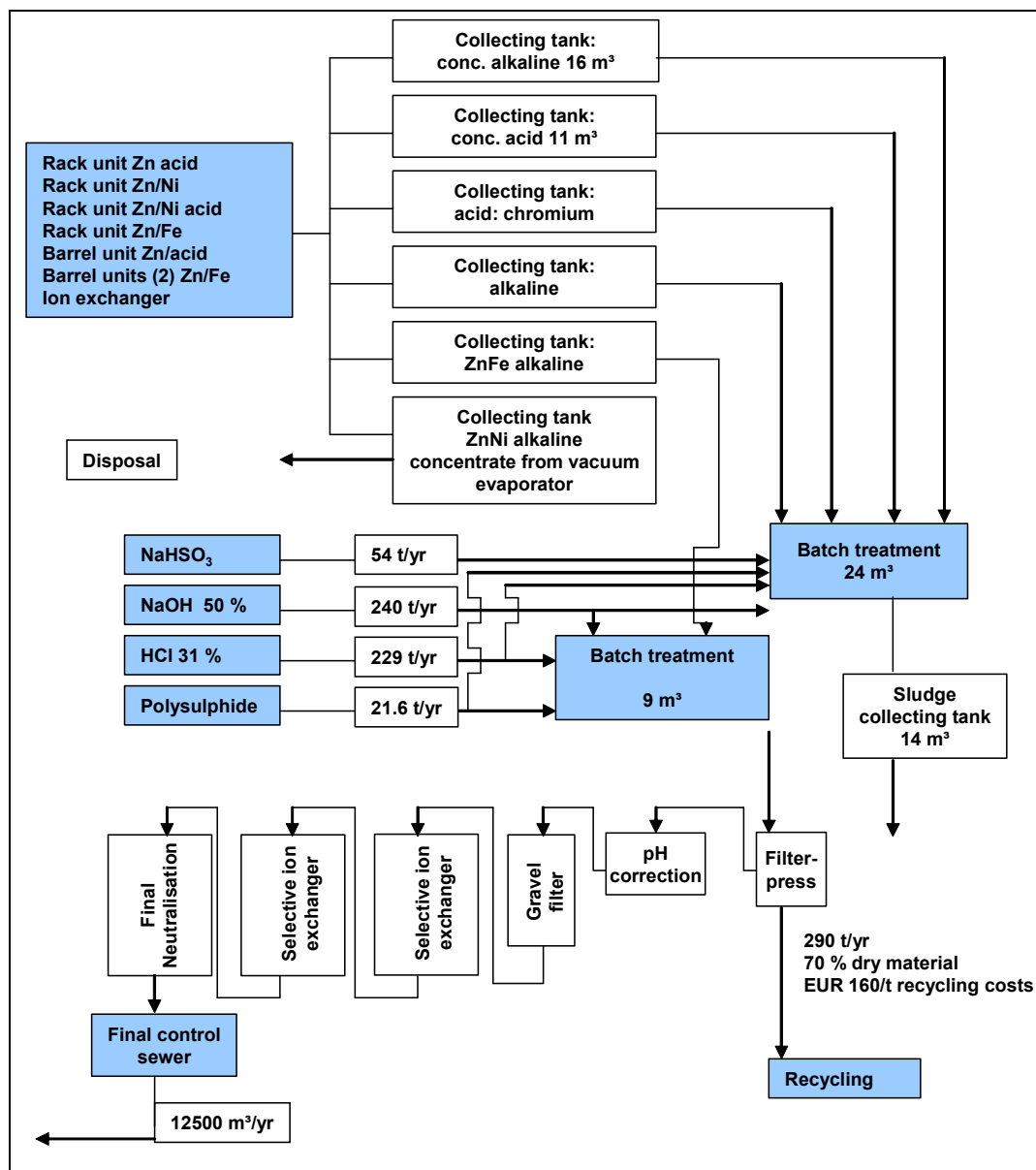

Figure 8.16: Plant H waste water treatment plant flow diagram

Waste water treatment

The waste water treatment is carried out in a central unit for all water-related production units, and the zinc-nickel line discussed represents only one part of the total amount and spectrum of the effluent (see Figure 8.16). The waste water treatment unit consists of two separately operating batch treatment units. The treated effluent is lead over a gravel filter followed by a final neutralisation in the final pH control stage. The hydroxide sludge is pumped to a filter press and then dried to 70 % solid content. Table 8.33 shows the usual emission levels achieved.

Parameter	Monitoring value mg/l	Measured values mg/l	
		Internal control	Authority control
Total Cr	0.5	0.3 – 0.4	0.4
Cr(VI)	0.1	<0.05	<0.05
Zn	2.0	1.6 – 1.8	1.7
Ni	0.5	0.3 – 0.5	0.4

Table 8.33: Plant H metal concentrations in the waste water

Within a volume of 40 m³ per week and an average concentration of 1.7 mg/l Zn and 0.4 mg/l Cr, an annual heavy metal load 3400 g zinc and 800 g chromium is discharged from this production unit to sewage.

Waste

The main source of waste is the sludge formed during the waste water treatment. It totals up to 60 tonnes with 70 % solid content, see Table 8.34.

Waste category	European waste catalogue No	Annual amount	Recycling/disposal technique	Costs for recycling/disposal including transport EUR
Cyanide free waste which does not contain chromium	11 01 03	60 t	Recycling in a metal work	160
Waste pickle		210 t	Use as pickle in a hot dip galvanising plant	175
Waste soda (cyanide containing)		24 t	Chemical treatment	750

Table 8.34: Plant H waste quantities

The annual losses of zinc within the waste are as follows:

$$60000 \text{ kg sludge} \times 0.7 \text{ solid content} \times 0.200 \text{ g zinc/kg dry sludge} = 8400 \text{ kg}$$

Further consumption figures for the zinc-nickel rack unit

The operating electrical loads of the individual plant elements are:

- automated plating line 587 kVA
- rectifiers 567 kVA
- filtration zinc bath 2.4 kVA
- microfiltration 2.2 kVA
- de-oiling 1 kVA
- cooling crystallisation 1 kVA
- compressed air 55 kVA
- dosing equipment 5 kVA
- waste water treatment unit including ion exchanger unit 30 kVA.

The exhaust air of approximately 75000 m³/h is cleaned with scrubber and mist eliminators.

Costs considerations

Investment costs:

- EUR 2000000 for the rack unit
- EUR 450000 for the waste water treatment unit

Operating costs:

- EUR 126000 for annual maintenance
- EUR 720000 for personnel costs for the three-shift operation
- For 6000 operation hours:
 - EUR 150000 for electricity
 - EUR 25000 for gas.

Costs for water and waste management:

- EUR 70000 for waste water treatment and ion exchanger unit
- EUR 3800 for fresh water
- EUR 6500 for sewage charge
- EUR 61000 for waste disposal.

The operational costs are shown per m² in Table 8.35

Costs	EUR/m ²
Process chemicals galvanisation	5.5
Chemicals for waste water treatment	0.37
Energy	1.75
Fresh water	0.04
Waste water	0.07
Waste disposal	0.61

Table 8.35: Plant H consumption costs EUR/m²

Estimated metal loss/efficiency

For Reference Plant H, the following figures can be calculated from the available data:

- input zinc: 23080 kg/yr, consisting of zinc semi-finished material 99.95 % Zn
- emitted zinc: 8400 kg/yr, according to 36.4 % of the input material, resulting in:
 - 3.4 kg/yr to sewage
 - 8400 kg/yr to waste.

8.5.8 Reference plant K

Age of the plant

13 years.

Type of plant

In-house shop.

Production programme of the entire enterprise

- mechanical processing
- zinc plating
- chromate finishing
- phosphating of screws and washers.

Production programme of the barrel plating unit

See Figure 8.17

- hot soak degreasing
- pickling
- electrolytic degreasing
- zinc plating (acid)
- copper stripping (cyanide)
- zinc plating (cyanide)
- chromate finishing (blue, yellow and black)
- phosphating.

Throughput

3294 t/yr (mainly small screws and washers) at 6800 working hours per year

Input materials

Chemicals	Process step	Quantity litres	Working concentration	Annual consumption (kg)	Annual consumption in EUR
Degreasing concentrate	Hot soak degreasing	5000	50 g/l	4000	7000
HCl	Pickle	4000	160 g/l	48400	9000
Sodium hydroxide	Electrolytic degreasing	4000	100 g/l	1400	500
Zinc anodes	Zinc electrolyte			53200	84000
Zinc chloride			40 g/l	6960	5080
KCl		40000	180 g/l	1920	1143
Boric acid			25 g/l	9600	33000
Cr-trioxide Ammonium chloride Sodium sulphate Sodium chloride	Yellow chromate finishing	600	7.5 g/l	6000	14000
Black chromate solution	Black chromate finishing	600	100 g/l	15000	47000
Blue chromate solution	Blue chromate finishing	600	40 ml/l		
Post dip solution	Post dip	3700	10 g/l	890	2600
Plating chemicals	Plating unit				203323
Caustic soda solution 50 %	Waste water treatment plant			5640	1270
Hydrochloric acid 30 %				7560	1135
Sodium bisulphite		--	--	1250	306
Total cost of chemicals for waste water treatment					2711

Table 8.36: Plant K input material

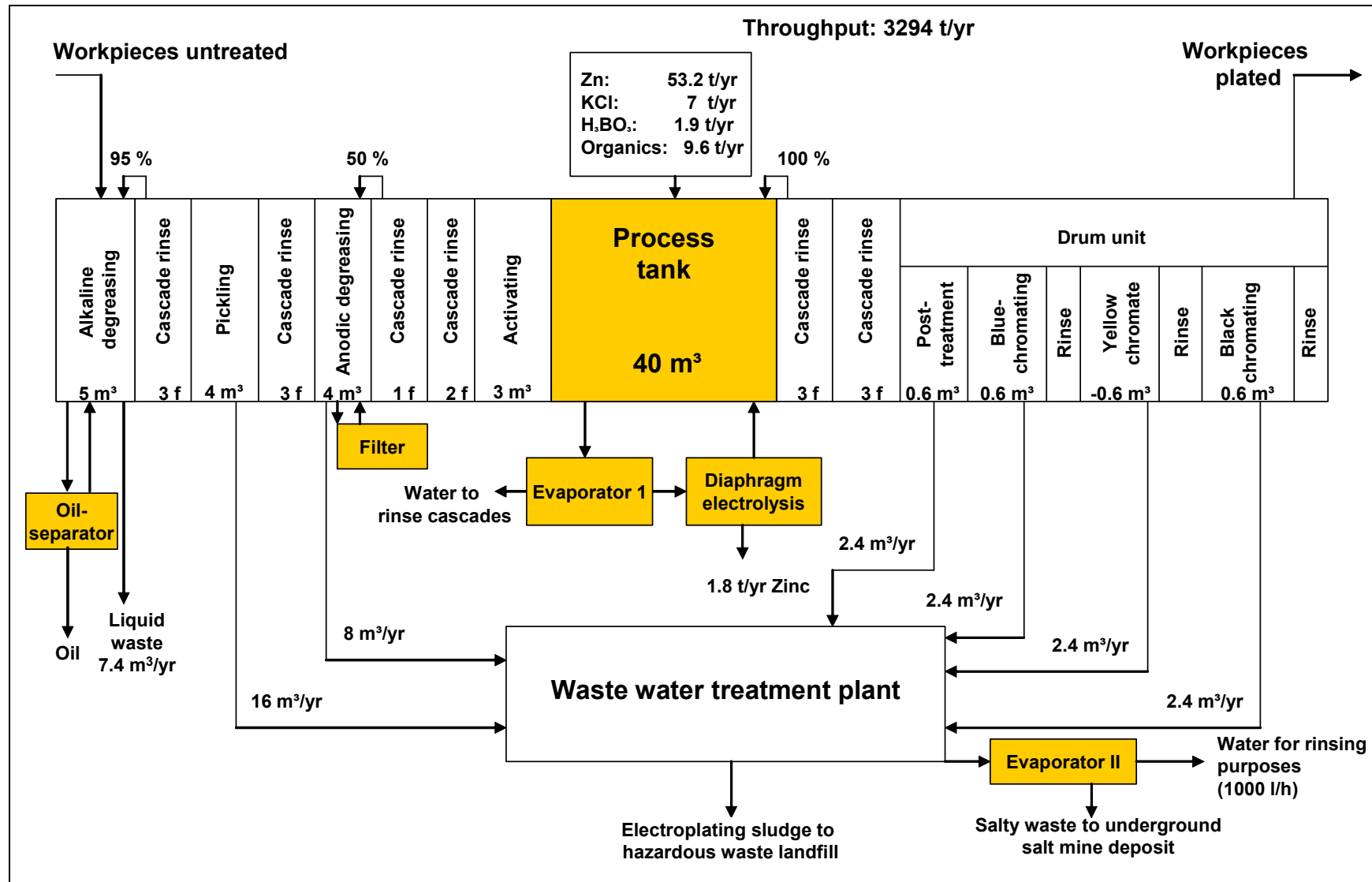

Figure 8.17: Plant K process flow diagram

Substitution for problem materials used

Currently there is no substitution of the materials used.

Measures for extending the service lifetime of solutions

The service lifetime of the process solutions is shown in Table 8.37

Process step	Chemicals	Concentration	Temperature	Service lifetime
Hot soak degreasing	Sodium hydroxide	50 g/l	70	26 weeks
Pickle	Hydrochloric acid	160 g/l	20	13 weeks
electrolytic degreasing	Sodium hydroxide	50 g/l	55	26 weeks
Zinc electrolyte	See Table 8.36	See Table 8.36	30	Infinite
Yellow-chromate	Chromium trioxide	7.5 g/l		13 weeks
Black chromate	Chromium trioxide	20 g/l		13 weeks
Blue chromate	Chromium III salt	1 g/l		13 weeks

Table 8.37: Plant K service lifetime of the process solutions

The service lifetime of the zinc electrolyte is infinite. This is achieved by continuous filtration and diaphragm electrolysis in combination with the natural drag out.

The solution for the hot soak degreasing is pumped to an oil separator to remove the free oil.

The electrolytic degreasing solution is filtered to remove the sludge.

The chromating solutions are given special treatments because of the complex chemical composition. The service lifetime reached in each case is regarded as sufficient from ecological and economical points of view.

The cycle of monitoring and refill of chemicals is shown in Table 8.38

Process step	Chemicals	Refill quantity	Analytic control frequency
Hot soak degreasing	Tenside	No data	1/week
Pickle station	Sulphuric acid conc., tenside	No data	1/week
Electrolytic degreasing	Caustic soda solution 50 % Slotoclean	No data	1/week
Zinc electrolyte	Calcium chloride	50 kg/week	1/week
	Boric acid	6 kg/week	Continuously
	Basic + gloss additives	50 kg/week	Continuously
Pickling	Hydrochloric acid 30 %	No data	Daily new beginning
Yellow chromating	Chromium trioxide	No data	2/week
Blue chromating	Chrome (III) salt	No data	2/week
Black chromating	Chromium trioxide silver salt	No data	1/week

Table 8.38: Plant K cycle of monitoring and refill of chemicals

Measures to reduce the drag-out

In all plating processes, the draining-off procedure of the electrolyte is optimised, by optimising the drum body and regime of drum turning.

Feedback of dragged-out process solutions

The feedback of dragged-out process solutions takes place by different routes:

- in warm working process solutions (degreasing) the evaporation losses are supplemented by the rinse-water of the compact rinse, so 90 % of the hot degreasing solution and 50 % of the electrolytic degreasing solution are fed back
- the rinse from the electrolyte is concentrated by a vacuum evaporator and the re-concentrated electrolyte is completely recycled. The distillate from the evaporator is used for rinsing purposes (see Figure 8.18.)

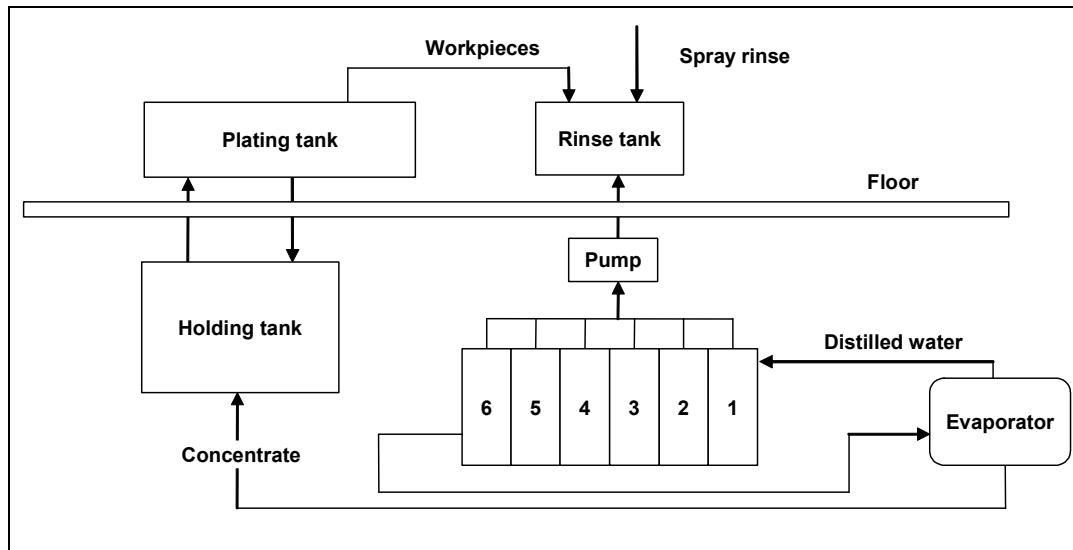

Figure 8.18: Plant K six step cascade rinse

Multi-stage rinsing with limited line space

The rinsing technology for the plating process is a six fold compact rinsing system described in 4.7.10.4 (See Figure 8.18). After the plating tank, the barrel is placed in an empty tank. This is sequentially filled from and drained to six off-line tanks, each holding what is, in effect, a static rinse water. When the first (most concentrated) rinse water reaches a critical concentration it is pumped to the evaporator. The concentrate is returned to the plating bath and the condensed distilled water is used in fresh rinsing. The entire process takes 60 seconds.

After the remaining process steps, rinses are two- or three-fold cascade rinses.

Waste water treatment with subsequent evaporation (waste water free operation)

The waste water treatment plant is a central unit for the entire plant, so that the plating unit discussed represents only a part of the total waste water. In each case, before the chemical oxidation and reduction, there is an anodic oxidation and a cathodic reduction. After precipitation, sedimentation and dewatering of the primary sludge takes place in a filter press. The filtrate is sent to the evaporator. The distillate (1000 l/h) is re-used for rinsing processes.

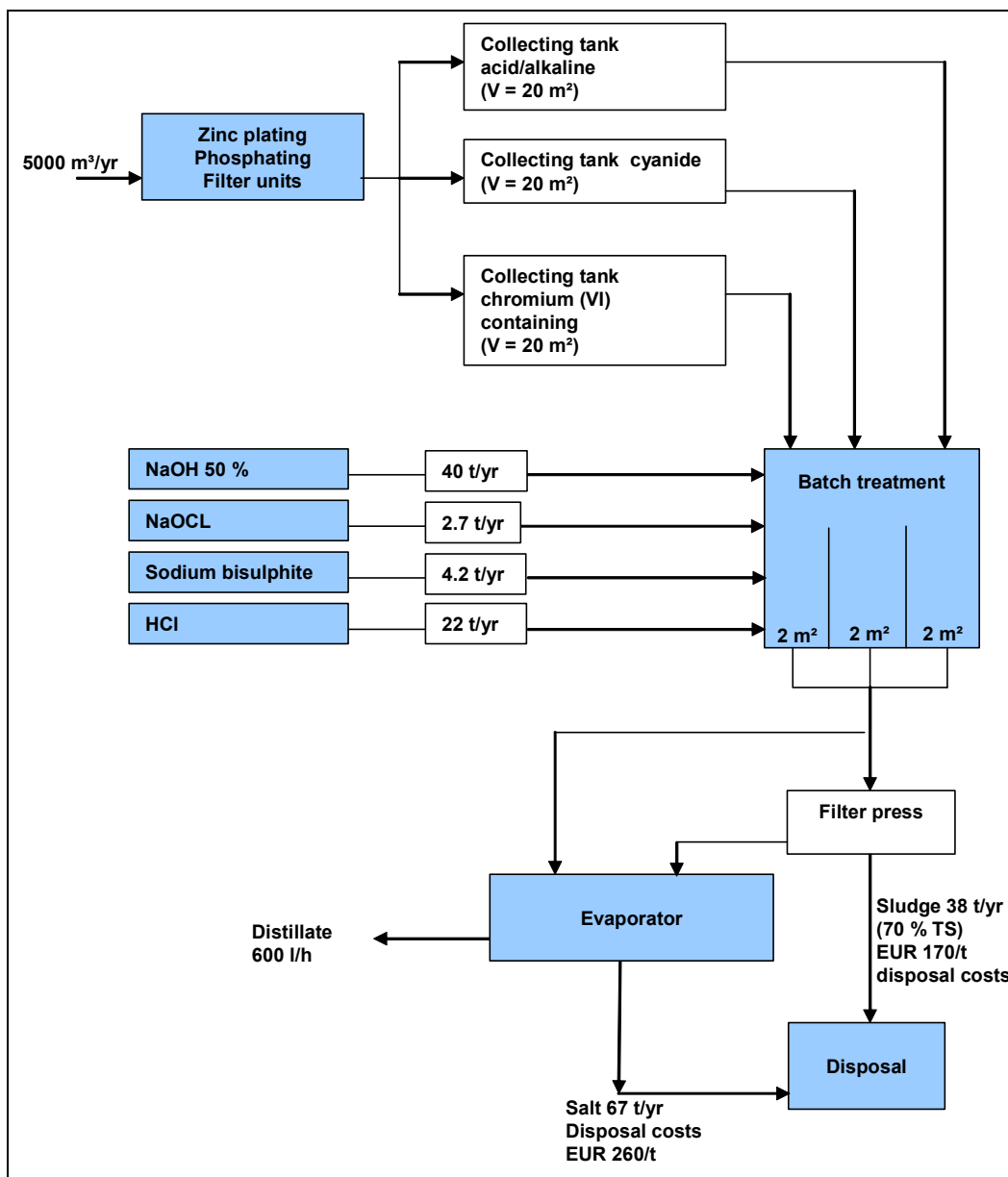

Figure 8.19: Plant K waste water treatment plant flow diagram

Waste amount

The main quantity of the resulting wastes arise from the solids (sludge), formed during the waste water treatment (precipitation and evaporation). See Table 8.39.

Type of waste	EWC no	Yearly amount	Disposal	Costs incl. transport EUR per tonne
Cyanide free wastes	11 01 03	21 t (70 % dry matter)	Landfill	500
Salt from evaporator		37 t	Deposit in salt mines	270

Table 8.39: Plant K waste quantities

Costs

The capital costs for the entire plant including the water free process technique is: EUR 4000000.

of this:

- EUR 900000 for vapour evaporator I
- EUR 250000 for vapour evaporator II
- EUR 100000 for disk drier
- EUR 125000 for diaphragm electrolysis, filter and dosing technology.

Proportionate annual maintenance costs for the plating unit are:

- EUR 25000 for material
- EUR 46000 for personnel.

Zinc inputs and outputs

For reference plant K the following zinc balance can be calculated from the available data:

- input zinc = 53200 kg/yr, consisting of zinc semi-finished material 99.95 % Zn
- emitted zinc = 5320 kg/yr, according to 10 % of the material input. Emission paths
 - 0 kg/yr via waste water
 - 5320 kg/yr via waste.

8.5.9 Reference Plant L

Age of the plant

8 years.

Type of plant

Job shop.

Number of employees

68.

Production programme of the entire enterprise

- plating zinc cyanide and alkaline rack unit
- plating zinc cyanide and acid rack and drum unit
- 1 x chromium plating: rack unit
- 1 x chromium plating: manual unit
- tin, nickel and chromium-plating: manual unit
- chemically nickel plating: manual unit.

Production program of the described unit (cyanide zinc plating)

See Figure 8.20:

- hot soak degreasing
- pickling,
- electrolytic degreasing
- cyanide zinc plating
- clarification
- transparency chromate finishing
- yellow chromate finishing
- black chromate finishing.

Throughput

468000 m²/yr at 7200 working hours per year

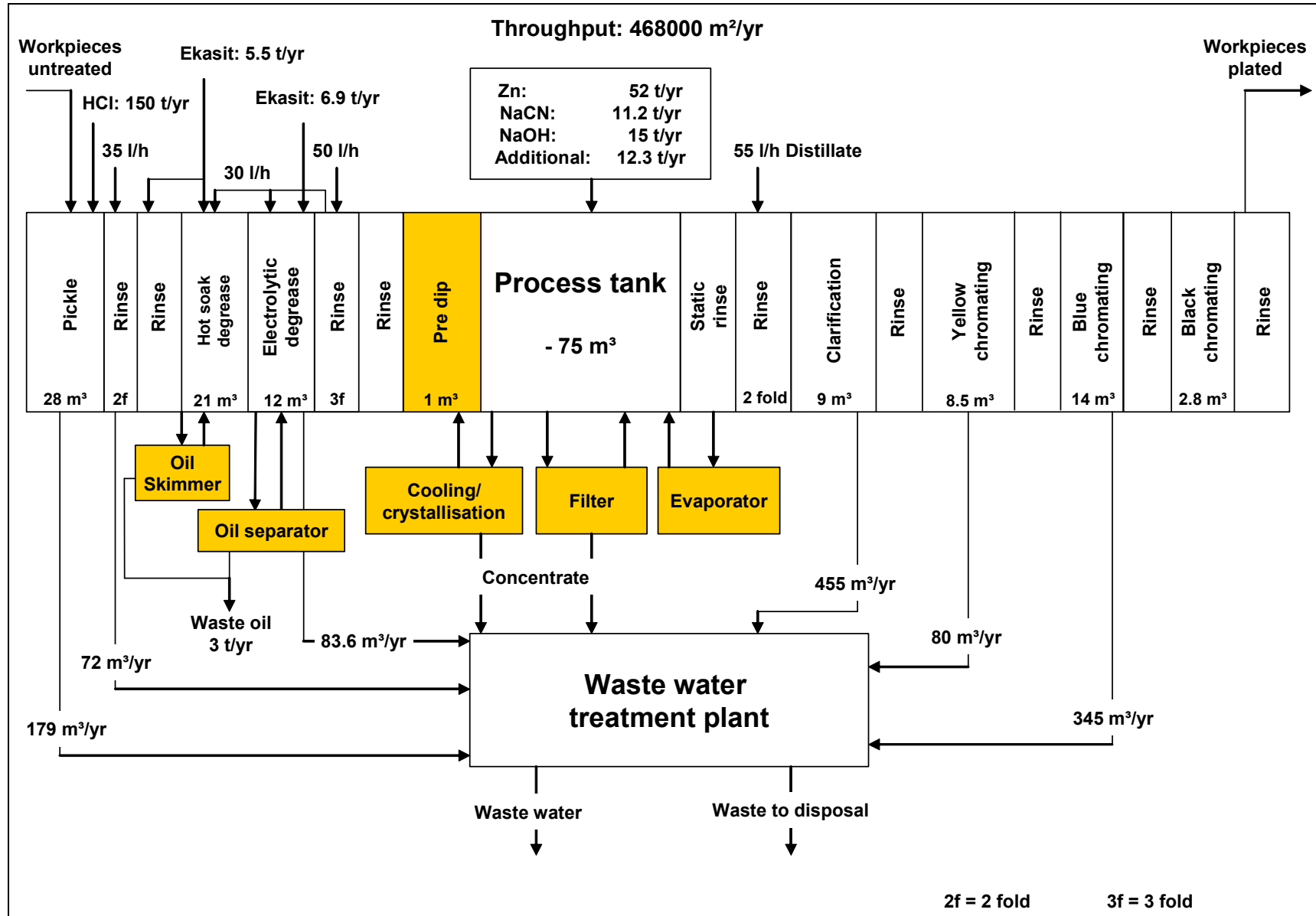

Figure 8.20: Plant L process flow diagram

Input material

Chemicals	Process step	Concentration	Annual consumption in tonnes	Annual consumption in EUR
Ekasit 2005	Hot soak degreasing	50 g/l	5.5	8250
Hydrochloric acid 31 %	Pickle	200 g/l	150	38000
Pickle degreaser		25 g/l	5.5	5500
Ekasit	Electrolytic degreasing	55 g/l	6.9	10350
Zinc anodes	Zinc plating		51.98	70135
Zinc oxide		20 g/l	2.77	6925
Sodium cyanide		60 g/l	11225	32552
Sodium hydroxide		92 g/l	15.06	18825
Gloss medium			12.3	32900
Nitric acid		Clarification	10 g/l	7.6
Basic solution	Yellow chromate finishing	1 g/l Cr(VI) -	0.55	5500
Basic solution	Black chromate finishing	20 g/l Cr(VI) 250 mg/l Ag	7.5	25000
Pro-seal X-Z 111	Blue chromate finishing	1 g/l	6.35	31750
Post dip solution	Post dip	10 g/l	1.5	1500
Total sum of inputs				290977
Caustic soda 50 %	Waster water treatment		40	24000
HCl 30 %			75	33000
sodium bisulphite			15	10200
sodium dithionite			2.5	8200
lime			10	2500
sodium hypochlorite			111	60000
Sum of waste water treatment chemicals				137900

Table 8.40: Plant L input material for plating and waste water treatment

Substitution of problem materials used

It is intended to replace the cyanide zinc electrolytes by alkaline cyanide free electrolytes.

Measures for extending the service lifetime of solutions

Analytic control, refill cycle and service lifetime of the process solutions is shown in Table 8.41

Process step	Chemical	Refill cycle	Analytic control frequency	Service lifetime
Hot degreasing	University bio clean	3/week	1/w	15 weeks
Pickle	HCl 30 % + Pickle degreaser	3/day	1/w	8 weeks
Electrolytic degreasing	Caustic soda solution 50 % Ekasit F15	3/d	1/w	7 weeks
Zinc electrolyte	Sodium hydroxide	3/w	Zn 5/w	Infinite
	Basis solution	Continuously	CN 5/w	
	Gloss additive	Continuously	OH 3/w	
Lighten	Nitric acid conc.	3/d	1/w	1 week
Yellow-chromate	AP plus	3/w	3/w	8 weeks
Blue chromate finishing	X Z 111	3/w	3/w	2 weeks
Black chromate finishing	ZBL-T	3/w	3/w	8 weeks
Sealing	Post dip solution	2/w	2/w	Infinite

Table 8.41: Plant L analytic control, refill cycle and service lifetime of the process solutions

The service lifetime of the zinc electrolyte is infinite. This is reached by the natural drag-out, a continuous filtration of the electrolyte and the installation of a cooling crystallisation unit to remove the carbonate.

For the remaining process solutions, no special treatments are carried out. A membrane filtration for the hot soak degrease solution did not work satisfactorily. The concentration of rinse-water from the chromate finishing solutions by means of reverse osmosis also failed.

Measures to reduce the drag-out

The draining times were optimised to a uniform 15 seconds. When pipes are plated, drag-out is strongly decreased by hanging them diagonally on the racks.

Feedback of dragged-out process solutions

The feedback of dragged-out electrolytes takes place two different routes:

- evaporation losses of the hot active baths are made up from the first rinsing tank after the treatment tank. The quantity of rinse-water feedback amounts to 30 – 40 l/h
- evaporation of the entire rinse-water after the plating tank by means of vacuum evaporators and feedback of the concentrate (6 l/h) as well as use of the distillate for rinsing purposes after the plating (30 l/h and 25 l/h).

Rinsing technology

The rinsing technology is generally a three step rinsing cascade in each case.

Exception to the three step rinsing processes are made after chromating. Here, one step rinsing of the chromate finishing is fed with circulating water from the ion exchanger.

In some cases, additional spraying flushing is used over the fluid level of the tank. For this, the spray of the last rinse is fed with 30 – 35 l/h demineralised water.

Due to high drag-out when pipes are plated, the hot soak degreasing and the pickle are equipped with one additional rinse step with demineralised water from the ion exchanger.

Waste water treatment

The waste water treatment plant is a central plant for all water-using production units, and the zinc plant described represents only one part of the total spectrum of the input waste water (see Figure 8.21).

The pretreatment and final treatment is carried out in two treatment tanks, one for cyanide streams and one for chromate streams with 30 m³ for each tank. After pretreatment and precipitation, there is sedimentation in settling tanks and dewatering of the sludge takes place in two filter presses. The cleaned water is transmitted to the sewer via a gravel filter, a final cation exchanger, a final neutralisation and the final pH adjustment.

The described plants produce 75 m³/week of waste water.

The heavy metal concentrations measured in the waste water are described in Table 8.42.

Parameter	Limit values mg/l	Control analysis mg/l		
		Internal	External	External
Total Cr	0.5	0.3	<0.05	<0.05
Cr (VI)	0.1	<0.01	<0.05	<0.05
Zinc	2.0	0.9 – 1.2	0.22	<0.22
Cyanide	0.2		0.24	<0.05

Table 8.42: Plant L concentration of heavy metals in the waste water after treatment

With a waste water quantity of 75 m³ per week and average metal concentrations of 0.22 mg/l Zn and <0.05 mg/l Cr, there are annual heavy metal loads of 825 g zinc and a maximum of 187 g chromium.

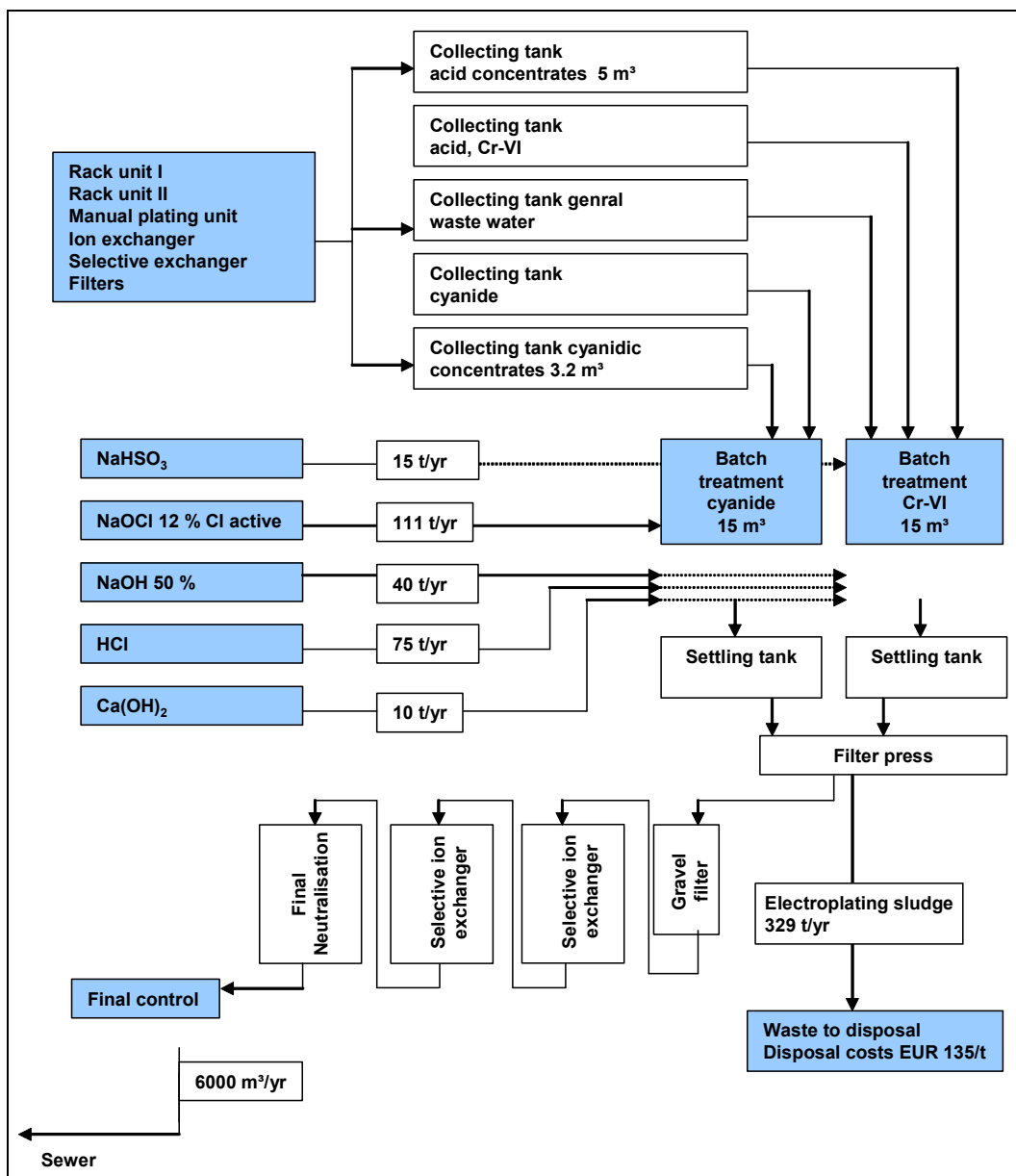

Figure 8.21: Plant L waste water treatment plant flow diagram

Waste generated

Type of refuse	EWC no.	Yearly quantity tonnes	Disposal route	Disposal costs including transport EUR/tonne
Cyanide free wastes, which contain chromium	11 01 03	181	Landfill	135
Cyanide containing wastes	11 01 01	9	Thermal destruction	640
Waste oil	11 01 07	3	Thermal re-use	470

Table 8.43: Plant L waste-quantities

	Content in g/kg dry matter
Zinc	200 (median value)
Iron	42
Cadmium	<0.1
Arsenic	<0.1
Solid content	40 %

Table 8.44: Plant L composition of electroplating sludge for metallurgical recycling

Costs

The capital costs indicated by the operator are:

- EUR 1500000 for the zinc plant
- EUR 845000 for the waste water treatment plant (entire)
- EUR 63000 for the cycle ion exchanger unit (proportionate)
- EUR 35000 for filtering units (zinc)
- EUR 10000 for the de-oiling mechanism
- EUR 32500 for cooling crystallisation unit
- EUR 125000 for the evaporator.

Annual maintenance costs for the plating plant:

- EUR 40000/yr for material
- EUR 40000/yr for personnel.

For the peripheral plants (production-integrated environmental protection) the following personnel expenditure is proportionately necessary for operation and maintenance:

- Filtration, de-oiling mechanism, cooling crystallisation:
 - EUR 10000/yr.
- Waste water treatment and cycle ion exchanger plant (proportionate):
 - EUR 7500/yr for material
 - EUR 50000/yr for personnel.

Table 8.45 shows the costs for Plant L as EUR/m² treated:

	EUR/m ²
Process chemicals galvanisation:	0.31
Chemicals for waste water treatment	0.15
Energy (river + long-distance heating)	0.24
Water purchase	0.025
Waste water and waste	0.08
Investment	0.56
Maintenance personnel/material	0.34

Table 8.45: Plant L costs as EUR/m² treated

Zinc inputs and outputs

For plant L the following are typical data:

- input zinc: = 51980 kg/yr, consisting of zinc semi-finished material 99.95 % Zn
- emitted zinc = 14481 kg/yr, according to 27.86 % of the input material:
 - via the waste water path = 0.8 kg/yr
 - via the waste path = 14480 kg/yr

8.6 Chromium usage for typical small decorative plating lines

This is one of three similar lines and typical of many chromium plating plants. The rinsing technique has some commonly used techniques ‘for closing the loop’: but the materials loop is not closed:

- tank size of the chromium bath: 100 x 70 x 120 cm (2040 litre)
- one eco-rinse tank (see Section 4.7.4) in the static rinse before chromium plating (concentration has to be controlled at $\text{CrO}_3 > 80 \text{ g/l}$ by dilution because otherwise the nickel under-layer is passivated and cannot be plated). This eco rinse is also used as the first step after chromium plating
- evaporation losses in the plating vat are replaced automatically with rinse water from the static eco rinse (the plating vat losses only 1 l/hr, has a surface area of 0.45 m^2 and runs at $43 \text{ }^\circ\text{C}$ temperature. The bath has air extraction)
- the static eco rinse is automatically refilled with deionised water with level control
- after the static rinse, there is a double cascade rinse (countercurrent water flow) and all the fresh water is firstly used as spray water by nozzles
- further rinsing steps discharge the residual chromic acid to the waste water plant.

Efficiency

- plated surface: $11000 \text{ m}^2/\text{yr}$ at an average thickness of $0.3 \text{ }\mu\text{m}$ chromium (typical for decorative bright chromium)
- plated chromium on the surface: 236 kg/yr
- chromic acid consumption: $870 \text{ kg/yr} = 452.4 \text{ kg/yr}$ chromium input
- metal efficiency approximately: 52% .

Material paths of the chromium

- plated on the parts
- air extraction system (waste; the same amounts of wastes are collected each year)
- chromium sludge in the bath (waste)
- rack stripping (metal hydroxide, waste but sold for external metal recovery)
- waste water plant (metal hydroxide $>99 \%$, waste but sold for external metal recovery).

Bullet points 2, 3 and 4 together are at least $3 - 5 \%$ of the input and can never be eliminated totally even in a completely closed loop.

Conclusions

- the metal efficiency of approximately 52% is typical of this type of small hexavalent chromium plating line
- for small chromium plants without a concentrator closed loop cannot be reached
- the thinner the plated chromium layer, the more difficult it is to reach a very good metal efficiency
- without the steps mentioned above moving towards closing the loop, the metal efficiency for decorative hexavalent chromium plating is only $20 - 30 \%$.

Source

[Martin Peter, Collini GmbH, March 2005].

8.7 Ion exchange – general description of techniques

Description

Ion exchange has been used commercially for many years in water treatment and the surface treatment industry. Its description therefore does not fall readily into any particular application, and new applications and new resin systems continue to emerge. Examples are:

- water deionisation
- water softening applications.

and in the surface treatment industry for:

- waste water treatment applications
- rinse-water recovery
- metals recovery. The most common applications include recovery of copper (from acid copper solutions), nickel and precious metals from plating rinse-water.

Ion exchange is a chemical reaction where ions from solutions are exchanged for ions attached to chemically active functional groups on ion exchange resins. Resins are typically classified as cation exchange resins or anion exchange resins. Cation resins usually exchange sodium or hydrogen ions for positively charged cations such as nickel, copper and sodium. Anion resins typically exchange hydroxyl ions for negatively charged ions such as chromates, sulphates and chlorides. Cation and anion exchange resins are both produced from three dimensional, organic polymer networks. However, they have different ionisable functional group attachments that provide different ion exchange properties. Ion exchange resins have varying ion-specific selectivities (preferences for removal). The following chemical equilibrium equation describes a cation exchange process:

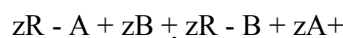

R - = Resin functional group
 A⁺ = Resin-bound cation
 B⁺ = Water phase cation
 z = Number of equivalents

Ion exchange systems typically consist of columns loaded with ion exchange resin beads. Process solutions are pumped through the columns for treatment. Key features of ion exchange column systems:

- ions are removed in a continuous flow system
- the ion exchange resins load in the direction of flow until the entire column is loaded
- resins can be regenerated, whereby acidic solutions are typically used to remove metals from cation exchange resins, and caustic solutions are typically used to remove resin-bound salts. Rinse solutions are used to remove excess regeneration fluids from the columns
- the linear flow velocity through the resin bed impacts on the ion exchange rate.

The major types of ion exchange resins include:

- strong acid resins: a typical strong acid resin functional group is the sulphonic acid group (SO₃H). Strong acid resins are highly ionised cation exchangers. The exchange capacity of strong acid resins is relatively constant over specific functional pH ranges
- weak acid resins: a typical weak acid resin functional group is a carboxylic acid group (COOH). Weak acid resins exhibit a much higher affinity for hydrogen ions than strong acid resins, and can be regenerated using significantly lower quantities of regeneration reagents. Dissociation of weak acid resins is strongly influenced by solution pH and has limited capacity below a pH of approximately 6.0
- strong base resins: a typical strong base resin functional group is the quaternary ammonia group. Strong base resins are highly ionised anion exchangers. The exchange capacity of these resins is relatively constant over specific functional pH ranges
- weak base resins: these exhibit a much higher affinity for hydroxide ions than strong base resins and can be regenerated using significantly lower quantities of regeneration reagents. Dissociation of weak base resins is strongly influenced by solution pH; resin capacity is influenced by pH and has limited capacity above a pH of approximately 7.0
- chelating resins: these behave similarly to weak acid cation resins but exhibit a high degree of selectivity for heavy metal cations. One common type of chelating resin is iminodiacetate resin. This resin has two carboxylic acid functional groups attached to a nitrogen atom that is attached to the resin polymeric structure. The carboxylic acid groups exchange with different cations, similar to a weak acid resin. However, the nitrogen atom can also form a ligand bond with metal cations, thereby adding another cation capture mechanism. Chelating resins are particularly selective for heavier divalent cations over monovalent or trivalent cations due to the presence of two desirably spaced functional groups.

The following bullet points indicate relative ion-specific selectivity preferences for common commercial ion exchange resin types. The ions on each list are ordered from highest to lowest selectivity:

- strong acid (cation) resin selectivity:
barium> lead> strontium> calcium> nickel> cadmium> copper> zinc> iron> magnesium> manganese> alkali metals> hydrogen
- strong base (anion) resin selectivity:
iodide> nitrate> bisulphite> chloride> cyanide> bicarbonate> hydroxide> fluoride> sulphate
- weak acid (cation) resin selectivity:
copper> lead> iron> zinc> nickel> cadmium> calcium>magnesium> strontium> barium> alkalis.
- chelating resin selectivity (iminodiacetate):
copper> mercury> lead> nickel> zinc> cadmium > cobalt> iron> manganese> calcium> magnesium> strontium> barium> alkalis
- chelating resin selectivity (aminophosphonic):
lead> copper> zinc> nickel> cadmium> cobalt >calcium> magnesium> strontium> barium> alkalis

The exchange capacity of typical ion exchange resins can be expressed in milliequivalent per litre (meq/l = ppm of ions/equivalent weight per litre). Table 8.46 presents typical exchange capacities for common commercial ion exchange resins.

Resin type	Exchange capacity (meq/l)
Strong acid (cation)	1800
Weak acid (cation)	4000
Strong base (anion)	1400
Weak base (anion)	1600
Chelating (sodium form)	1000

Table 8.46: Typical ion exchange capacities for general resin types (in milliequivalents per litre, meq/l)
[162, USEPA, 2000]

Achieved environmental benefits

See Applicability, below.

Cross-media effects

Chemicals used in regeneration.

Impacts of waste solutions from regeneration.

Energy consumption used for pumping.

Operational data

Typical system components include:

- ion exchange columns with resin
- process pumps, piping and valves
- regeneration tanks, pumps and piping
- regeneration chemicals and chemical mix systems
- pre-filters (to remove solids and organics)
- process controls (for automated or semi-automated regeneration cycles).

Depending on the application, various combinations of anion, cation, and mixed-bed (anion/cation) resins may be used.

Applicability

See Description, above, including use for water deionisation and water softening applications. This to improve the incoming water quality to the installation or process line, and can improve process solution quality by removing unwanted ions (and therefore improves product quality and extends bath life) and for rinsing, to ensure workpieces dry without leaving blemishes of dissolved solids.

Ion exchange is also an excellent technology for recovering plating chemicals from dilute rinsewaters. In the typical configuration, rinse-water containing a dilute concentration of plating chemicals is passed through an ion exchange column where metals are removed from the rinse-water and held by the ion exchange resin. When the capacity of the unit is reached, the resin is regenerated and the metals are concentrated into a manageable volume of solution. It is important to note that in some cases less treatment capacity is required to recycle rinse waters than to treat incoming water and treat the subsequent rinses, as the ion-loading or TDS may be lower.

For conventional chemical recovery processes, systems are designed with either cation or anion beds, depending on the charge of the ionic species being recovered. After passing through the column, the treated rinse-water is discharged to the sewer or undergoes subsequent treatment. In most cases, rinse-water is recycled to the process. Such systems include both cation and anion columns to completely deionise the rinse-water.

Drag-out recovery tanks can be combined with ion exchange to reduce the required capacity of the ion exchange columns. Using this configuration, the drag-out tank(s) are followed by an overflow rinse that feeds an ion exchange column. In operation, the drag-out tanks return the bulk of the plating chemicals to the plating bath and an ion exchange column captures only the residual chemical load. This reduces the ion exchange system size requirement.

Applicability - secondary stream(s)

Regenerating chemicals can be selected to optimise the products derived from the regeneration of ion exchange resins. Chemicals are selected to produce salts that can be directly recovered in the treatment process. Metals can be recovered via electrolysis and salts are recovered offsite. Depending on the chemical product specification of the recovery process, the regenerated solution can be returned directly to the plating tank for re-use, further processed, or the metals recovered by another technology, such as electrolysis. The most common applications of this technology are in the recovery of copper, nickel and precious metals. Countercurrent regeneration mechanisms can result in significantly lower chemical use for regeneration as the regenerated zone is always maintained in a 'clean' condition. Co-current regeneration requires higher chemical use and/or results in lower initial water quality as the 'regenerated zone is left in a semi-contaminated state following regeneration.

Applicability - limitations

Common limitations for ion exchange:

- ion exchange may become impractical for use with total dissolved solids concentrations above 500 ppm, due to the need for frequent regeneration
- resins have different effective pH ranges. For example, iminodiacetate chelating resin works best in a slightly acidic range; selectivity is lower at higher pH and below a pH of approximately 2.0
- oxidants, solvents, organics, oil and grease can degrade resins
- suspended solids can clog resin columns.

Economics

Situation specific. See Example plants, below.

Driving force for implementation

Situation specific.

Example plants

See specific applications and examples in the following sections:

4.4.5.1. Water supply, treatment and recycling/re-use

4.7.8.1 Regeneration by ion exchange

4.7.10 Multiple rinse techniques

4.7.12 Combining techniques and installation-wide approaches

4.10 Common techniques for treating waters and aqueous solutions: feed-water, rinses, waste water treatment, process solutions, and materials recovery

4.11.7 Ion exchange purification of metallic contamination

4.12.2 Ion exchange – recovery of precious metals from rinses

4.14.17.3 Continuous removal of iron and re-use of the zinc bath (large scale steel coil)

4.16 Waste water emission abatement techniques

Reference literature

[104, UBA, 2003, 162, USEPA, 2000]

8.8 Ultrasonic cleaning – example plants

Automatic plating line

The generators, which are located close to the vessel, supply the transducers with a high frequency and high potency electrical signal (in this case 4000 W to 25 kHz because they are tubular transducers). Inside the transducers, there is a piezoelectric effect which, when it receives this signal, starts to vibrate and produces mechanical waves through the environment surrounding it. The system requires a chemical degreasing bath, and accelerates cleaning by improving removal of oils or other impurities from the parts.

Plant details

Volume – 4950 litres

System of 15 tubular transducers with 4000 W of power (although the work power does not exceed 1500 W)

Stainless steel AISI 316 vessel with a thermal-coated double wall

Temperature – 70 °C (65 °C to 75 °C)

Energy – heating by a 25 mm diameter coil with water heated to 85 °C. It has three auxiliary resistances of 3000 W to supplement the heating.

Duration of bath (renewal) – 2 weeks (operating for 16 hrs per day)

Cleaning time – functioning of the ultrasounds from 0 to 3 minutes (depending on the type of material – stainless steel, iron or brass, and whether it is polished or not or contains large amounts of oil)

Auxiliary equipment – a filter pump with cartridges (8 m²) for the removal of insoluble particles (13000 l/h)

Products – alkaline grease remover with concentrations of 30 g/l (25 to 35 g/l).

Washing after polishing with an automatic machine

Volume – 230 litres

System of two plate transducers with 1000 W of power.

Stainless steel AISI 316 vessel with a thermal-coated double wall

Temperature – 70 °C (65 °C to 75 °C)

Energy – one 2000 W resistance for heating.

Duration of bath (renovation) - weekly (operating 8 hours per day)

Cleaning time – permanent functioning of ultrasounds (they work only for cleaning polished brass (large quantities of paste)

Caution – initial degasification of the bath.

Products – acidic grease remover with a concentration of 35 g/l.

Cross-media effects for both examples

Waste – from the filter pump, including cartridges and those associated with water treatment (sludge). Their quantity depends on production volume

Noise – high frequency sound (25 kHz). If the ultrasounds start to function without parts, the noise causes discomfort to the human ear, since the equipment vibrates and has high diffusion because there is no insulation. In the case of normal operation, the noise is heard only close to the working zone

Gaseous emissions – a system for capturing vapours with a scrubber system is recommended (as for hot alkali cleaners)

Waste water – treated as a normal degreaser, i.e., neutralised with precipitation of the dissolved metals as a sludge.

Control of parameters for both examples

There is initial degasification of the bath on first use as well as vibration in normal use. Careful securing of the parts to the jigs is therefore required, as the vibration can cause them to fall off.

Weekly laboratory control of alkalinity/acidity of the bath.

Reference literature

[158, Portugal, 2004]

8.9 Example plant for the reduction of the volume of extracted air

Description

The KCH ACTSEC technology is a system designed to provide an efficient removal of air contaminants from the workplace at a reasonable cost and at a level that minimises the overall power consumption and exhaust volume to the air pollution control device. This installation is set up as one semi-automated process control system. The process is wash and etch of titanium parts. The lids and exhaust are automated. All vented tanks are fitted with covers that open and close as the hoist moves over the tank to load or unload parts for washing or etching. The line is exhausted via its own exhaust system, comprised of a scrubber and fan. Each vented tank has two lateral exhaust hoods, each with its own volume damper. The volume dampers are interlocked with tank covers and open and close at the same time. This allows for an increase in airflow through the hoods as required when the covers are in the open position. The exhaust system has a bleed-in air control damper, located between the line hoods and the scrubber, that opens and closes as required to compensate for the fluctuation in static pressure due to the opening and closing of tank covers and hood dampers. This maintains a constant volume and static pressure through the scrubber and fan. The system provides a constant volume with a slight negative airflow in the room. Make-up air is brought in from the outside, tempered, and distributed throughout the room.

Achieved environmental benefit

The measured flowrate of 514 m³/m is a reduction of 905 m³/m from the baseline design flowrate of 1419 m³/m for a tank system without lids.

Total energy savings are 1108852 kWh/yr.

Cross-media effects

None apparent.

Operational data

Titanium wash and etch line:

- 15m long; six process tanks 13 m³ volume
- 4.3 m long x 1.2m wide x 2.4m deep
- one lid opening at a time
- two tanks of 1.4 % nitric acid/0.14 % hydrofluoric acid
- design airflow without lids: 1419 m³/minute.

Verification of performance

The technology was tested to verify if the statements made by the vendor as to the energy savings from decreased power requirements were accurate.

Economics

A cost analysis of the technology was performed using current operating conditions. The reduction in the size of the scrubber and the induced draft fan due to the lower ventilation requirements with the lids in use results in a lower cost for equipment and power requirements. The reduction in the size of the induced draft fan is significant. The facility anticipates a saving of USD 65884 yearly, which is comprised of energy and O&M cost savings. Additionally, the initial capital expenditure is significantly reduced due to component size reduction. A capital cost saving of USD 61283 is anticipated.

Operation and maintenance labour

Operation and maintenance (O&M) labour requirements for the technology were not monitored during testing. However, O&M information obtained from the facility indicated yearly O&M costs were USD 8547.

Cost savings calculation

(Report work carried out 2000, report date 2002):

- the system cost without the KCH ACTSEC USD 187272
- the system cost with the KCH ACTSEC USD 125989
- reduction in extraction equipment saves USD 61283

- annual energy cost saving = USD 48790
- annual O&M cost saving = USD 17094

- annual energy cost savings + O&M cost savings = total annual savings
- USD 48790 + 17094 = USD 65884 Total annual savings.

Driving force for implementation

Air extraction system is required to meet environmental and occupational health requirements. Costs savings for this system.

Summary

The test results show that the KCH ACTSEC technology, when placed on a tank system with ventilation and heating requirements, results in a smaller load demand for power and a reduced need for ventilation to meet ACGIH standards. Consequently, a smaller scrubber, scrubber pump motor, and induced draft fan are needed when the KCH ACTSEC technology is used. This translates into not only a reduced power demand, but also a lower equipment cost. The cost of the power consumed by the lid motors is small compared to the overall savings when the lids are used. Furthermore, the reduction in energy used by a facility using the KCH ACTSEC technology results in a corresponding reduction in atmospheric pollutant emissions from any fossil fuel power plant supplying the energy.

Reference

http://www.epa.gov/etv/pdfs/vrvs/KCH_Final_Report.pdf
[167, USEPA, 2002]

Example plant

Goodrich Aerospace Landing Gear Division, Tullahoma, Tennessee.

8.10 Table of comments on the use of hexavalent and trivalent chromium

Advantages of hexavalent chromium (Cr(VI)) plating	
Advantage	Comment
Can build thick layers necessary in hard chrome applications	Current commercial options to hard chromium are listed in a paper from NEWMOA (see [108, NEWMOA, 2003]). In some cases there are no alternatives to Cr(VI) electroplating
High hardness 700 to 1000 HV (harder than from Cr(III)), corrosion-resistant, micro-cracked and retains lubricants, low friction resistant, anti-adhesive, machinable, thermally resistant	Untrue: coatings from Cr(III) achieve similar hardness values. May be affected by thickness of coating. Other attributes from Cr(III) are similar to Cr(VI) (see below)
Widely used, well established, easily applied and low cost	Cr(VI) Decorative coating: 650 sites in Germany, turnover EUR 21000 million/yr Cr(VI) Hard chromium: 285 sites in Germany, turnover EUR 840 million/yr
Glossy coatings are generally deposited from Cr(VI) solutions	Glossy coatings are also obtained from Cr(III) solutions
Surface treatment specifications for key applications (e.g. automotive) specify Cr(VI)	
Advantages of trivalent chromium (Cr(III)) plating (both chloride and sulphate based)	
Advantage	Comment
Lower toxicity	No additional health and safety requirements Will not trigger Seveso Directive limits
Higher cathode efficiency	No hydrogen formed and less spray Energy saving is significant (see case studies and example plants, Section 4.9.8.3) and exceeds increased chemical costs, giving good payback time for change-over and increased profits.
Better covering and throwing power. Achieves higher racking densities and therefore higher parts throughput per shift	Increased profitability reported in case studies
Lower current density. This requires lighter weight and less expensive jigging.	Increased profitability reported in case studies
Process insensitive to current interruption (hence no whitewashing) and almost impossible to burn. Reject rates down (by 66 % reported)	Increased profitability reported in case studies
Widely established in the US, and at least 100 sites worldwide Used by two major cooker manufacturers in Europe for 7 years, for parts subject to heat, humidity and cleaning with strong acid or caustic cleaners and abrasive materials	
Lower chromium content of solutions results in lower viscosity, resulting in lower drag-over, less effluent contamination, and less staining of work	
Less waste produced than Cr(VI) process: up to 80 % reported. Also, no dissolution of anodes to lead chromate sludge	
Overall net profit up due to reduced effluent treatment, reduced waste and waste charges, fewer rejects, reduced air monitoring, increased throughput. Lower insurance premiums are possible for Cr(III) operators because of lower worker risk	
Solutions are less concentrated, not oxidising and are cleaner and less corrosive to handle, use and are less corrosive to plant and equipment	
Cr(III) plating solutions can be regenerated by porous pot or membrane filtration	

Disadvantages of hexavalent chromium (Cr(VI)) plating		
Disadvantage	Comment	Counter-comment
<p>Very toxic to humans and the environment. Current/proposed classifications:</p> <p>$\text{Na}_2\text{Cr}_2\text{O}_7$ very toxic/very toxic Na_2CrO_4 toxic/very toxic CrO_3 toxic/very toxic</p> <p>All: very toxic to aquatic organisms (R50/53)</p> <p>Very toxic (human health) triggers Seveso II Directive threshold of five tonnes per installation</p>	<p>Control measures well understood and can be readily applied: including spray suppression, fume extraction, reduction of Cr(VI) readily in effluent treatment with flocculation and precipitation. Can be used in closed loop with countercurrent rinsing, evaporation, etc. May be used in specialised, enclosed production lines for high volume production of similar sized components</p>	<p>Measures for control, such as fume extraction, give rise to other environmental impacts One key measure involves the use of PFOS in vats to reduce chromium spray formation: PFOS has toxic and bioaccumulative effects, and is now under investigation (see Section 8.2). Largest manufacturer ceased production 2002 Insurance premiums for health and safety may be higher as a result of occupational health issues</p>
<p>Low cathode efficiency, poor metal distribution with excessive build up in high current areas and poor coverage in low current areas, lack of coverage around holes, sensitivity to ripples in power supply and 'white washing' (opaque/cloudy finish: a common problem). High reject rates. High energy costs.</p>	<p>Auxiliary anodes can be used to improve throw</p>	
<p>Poor current efficiency due to 85 – 90 % electrical power generates hydrogen, causing bubbles which break forming a Cr(VI) mist.</p>	<p>See control measures (see first row of this table, above)</p>	
<p>Drag-in and etching (sometimes in the chrome vats) in the strong acid electrolyte increase impurities such as Fe, Cu, Ni, and Cr(III) (this is also generated in the process). These must be removed by chemical precipitation, plating out, ion exchange resin columns, or membrane electrolysis or electro dialysis. Normally ion exchange is on the first static rinse to prevent degradation of the resin. This is essential</p>		
<p>High chemical concentration in the vats: typically 180 – 450 g/l</p>	<p>Concentration up to ten times higher than Cr(III) baths. This increases viscosity and with high concentration gives high Cr(VI) drag-out</p>	
<p>High waste production from high solution strengths (where there are discharges from rinsing)</p>		
<p>Typically uses lead anodes, which decompose over time, forming lead chromates (toxic) which slough off the anodes and accumulate in the tank, requiring filtering and removal</p>		

Cr(VI) is a strong oxidant and attacks equipment used in its control, such as plastic air ductings etc, causing corrosion in the working atmosphere and deterioration of plant and equipment		
Dried Cr(VI) electrolytes have been known to cause fires in plating shops		
Cr(VI) plating solutions require specialist regeneration or discarding for recovery of the metal in the waste solution		
Disadvantages of trivalent chromium (Cr(III)) plating (both chloride and sulphate based)		
Disadvantage	Comment	Counter-comment
Solution reactions limit thickness, and hence cannot be built up to the requirement for hard chromium applications	Cr(III) solutions cannot currently achieve thick films. A patented process to overcome this is at preproduction trials. For information, see Emerging Techniques, Section 6.2	
Corrosion stability, hardness and wear resistance is lower than Cr(VI)	Reported measured hardness figures are similar to Cr(VI) solutions. At present, it is not possible to build thick coatings for engineering applications. Corrosion may be due to porosity of the coating or lack of passivation effect (see rows below). Where high corrosion resistance is not required (e.g. indoor applications) the Cr(III) coating will outlast the life of the parts. Cr(III) has been used extensively for about seven years by major companies making cookers, where parts are subject to heat, humidity, abrasive and strongly acid or alkali cleaning agents and abrasive cleaning materials, with no reported problems	
Cr(III) solution does not passivate in areas where it does not plate. This can lead to corrosion on parts with significant blind areas, such as tubes	Parts with blind areas should be rinsed rapidly and passivated subsequently with a Cr(VI), phosphate or organic passivating solution	
Dissolution of substrate dissolved from blind areas (Cu, Zn from brass) can give rise to an increase in the contaminants and other dragged-in contaminants (Ni from a previous plating stage) can affect the colour of the plating, causing darkening and can decrease current efficiency	It is essential to control this by maintenance using ion exchange or precipitating agents followed by filtration. Filtration with activated carbon is essential to remove organic breakdown products	
Colour is different to Cr(VI) decorative coatings. Colour for Cr(III) chloride reported as dark grey/bright or yellow/bright and for Cr(III) sulphate as white/bright compared with Cr(VI) blue/bright	1. Colour is affected by contamination build up (see row above) 2. Differences in colour can be matched by the addition of iron (or other additives). The co-deposition with iron and some other ions improve plating properties. If colour match is critical, then parts may have to be produced by the same processes	
Cr(III) requires expensive membrane electrodes that are susceptible to damage and poisoning	Membrane electrodes can be used, but are now largely replaced with cheaper and more robust graphite or composite anodes. Organic additives prevent oxidation of Cr(III) at the anode. Shielded lead anodes and insoluble catalytic anodes maintained at an electrode potential level that prevents oxidation of the Cr(III)	

Cr(III) solutions contain complexing agents that interfere with other waste water treatment	This may be possible hypothetically, but no problems have been observed or reported. In one case study the operator of Cr(III) with electrolytic recovery of the Cr achieves metals levels low enough to avoid further effluent treatment	
Cr(III) solutions contain chloride and release chlorine. The oxidation of other materials by chlorine can lead to the production of AOX in effluents. The release of chlorine produces lots of small bubbles in the solution and are a source of pitting in the plating	This problem only existed for chloride based solutions, and not sulphate solutions. It was resolved 20 years ago by additions which prevent chlorine release. The choice of additives and the usual regular maintenance by activated carbon filtration will prevent release of AOX. No problems have been observed at site visits or reported from case studies or operators No pitting problems are reported by case studies or site visits, which report better quality output from Cr(III) as a key advantage. A large number of hydrogen bubbles are also produced in Cr(VI) solutions	
Cr(III) solutions require more control and costly equipment to maintain solutions	The additional controls are no greater than those required to run the nickel solutions that precede the Cr step in decorative plating The additional equipment (ion exchange, activated carbon filtering) is similar to that required for closed loop Cr(VI)	
More complex solution chemistry requires more chemicals. More costly to run	True but case studies report significant overall savings as a key reason for change. See overall profit, in Advantages table, above.	
Cr(III) cannot be run on a closed loop because it is based on a ligand exchange reaction which cannot be revoked by heating or other processes		
Make up of Cr(III) solutions may be more than is normally lost through evaporation and drag-out. Evaporation of the bulk bath is one method of returning to the original volume		

8.11 Example of plant optimisation calculations

This example plant is an automatic barrel line carrying out zinc plating and passivation. The software also has a simulation of a jig (rack) plant. In the software, clicking on a specific process tank links directly to the appropriate page (shown in the following pages).

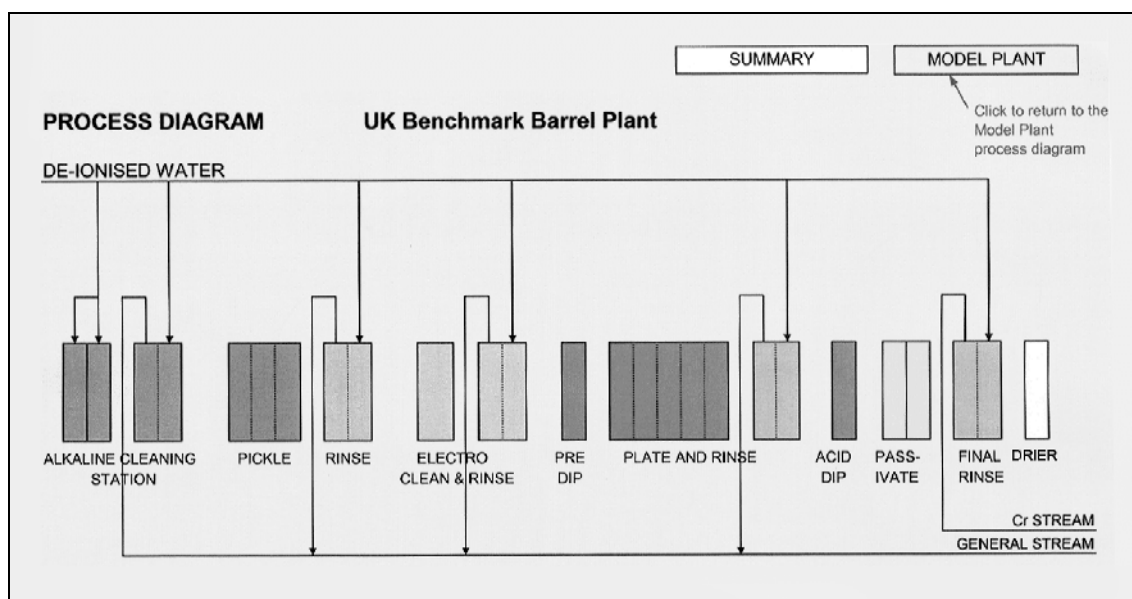

Figure 8.22: UK industry average plant schematic

Note: 'UK Benchmark' here means average type of plant before improvements are made. It does not mean 'benchmark associated with BAT'.

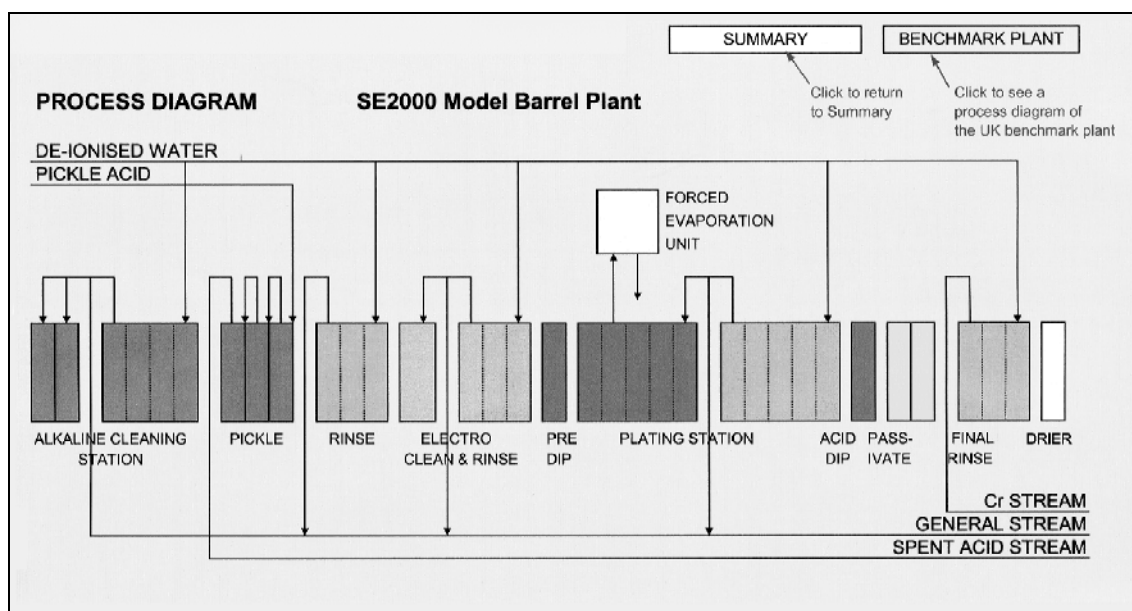

Figure 8.23: Industry optimised 'good practice' plant, SE2000

Note: This plant employs some in-process techniques mentioned in Chapters 4 and 5

SUMMARY OF IMPROVEMENTS- Barrel Plant						
Process	Rinse Stages		Water used		Capital Cost	Cost Savings
	Own	Mod.	Own	Mod.		
	Plant	Plant	m ³ /year		£	£/yr
Alkaline cleaning station	2	4	2 748	411	1 950	5 551
Pickle process configuration:	Batch	Cascade	-	-	500	13 531
Rinse after Pickle	2	3	2 748	774	1 300	2 171
Electroclean & Rinse	3	4	774	411	1 300	985
Pre-Dip	-	-	-	-	-	-
Plating Station with Rinse	3	5	886	305	16 950	14 581
Acid Dip	-	-	-	-	-	-
Passivate	-	-	-	-	-	-
Rinse afterpassivate	2	3	4 344	1 051	1 300	3 623
Dryer	-	-	-	-	-	-
			Total water used, m ³ /year:		11 500	2 951
Total of above specific costs and savings					23 300	40 441
Plus common infrastructure costs - mods to services/buildings, etc.					0	
Total cost					23 300	
Payback period, at interest rate			10 %		0.6	years

Figure 8.24: Summary of improvements made from average (benchmark) plant to good practice

The page summarises all the calculations and results shown in the following example pages. For a barrel automatic plant operating 24 hours a day, 5 days a week, 48 weeks a year and the following characteristics:

- alkali zinc plate and chromium passivation
- increasing rinsing after alkali cleaning from two to four counterflow rinses
- changing acid pickling from one batch tank to three stage counterflow cascade
- increasing rinsing after alkali cleaning from two to three counterflow rinses
- adding an eco rinse tank
- increasing rinsing after plating from two to five counterflow rinses
- increasing rinsing after plating from two to three counterflow rinses.

The water, energy and chemical costs were set for average costs in year 2000.

With an interest rate of 10 % and inflation at 0 %, the payback time for the modifications are:

- cost of plant modifications: GBP 23300 with a payback time of 0.6 years
- if an estimated cost of infrastructure modifications of GBP 50000 is entered into the programme, then the payback period becomes 1.8 years.

All the costs can be varied to be appropriate to any site, such as operating periods, size of plants, inflation, interest rate values, costs of water, electricity, heating, chemicals, etc.

This is page is used to vary key standard data for the whole plant.

STANDARDS		
These figures are used throughout the application	User set value	Normal Value
Operating hours per day	16.0 hours	16 hours
Operating days per week	5 days	5 days
Operating weeks per year	48 weeks	48 weeks
Availability	80 %	80 %
Effective operating hours per year	3 072 h/year	h/year
Cost of water IN	0.70 £/m	0.70 £/m
Cost of trade effluent discharge	0.40 £/m	0.40 £/m
Barrel nominal size	1100 mm	760, 1300 or 1200 mm
Tank length (along plating line)	900 mm	
Tank width	1800 mm	
Tank height	900 mm	
Capital cost per tank incl. inflation	1300 £	£ 1500, 1300 or 1100
Inflation since January 2000	0 %	0 %
Interest rate	10 %	10 %
Cost of electricity	0.040 £/kWh	0.040 £/kWh
Cost of hot water heating	0.010 £/kWh	0.010 £/kWh

Figure 8.25: Page showing where standard factors are entered for calculation

This page allows the drag-out rate to be varied according to specific plant conditions, or the default values can be used.

STANDARDS		
These figures are used throughout the application	User set value	Normal Value
Drag-out per barrel	<input type="text" value="2.0"/> litre/barrel	1.5 litre*
Plant output, barrels per hour	<input type="text" value="10"/> per hour	10 per hour
Drag-out rate	<input type="text" value="20.00"/> litre/ hour	

* Typical figure for a 1100 mm size barrel, as currently selected

Figure 8.26: Page setting drag-out rates

This page allows data to be set for a specific plant for alkaline cleaning, and a comparison against the modified plant to show costs for changes to this process and the payback period.

ALKALINE CLEANING STATION	OWN PLANT		MODIFIED PLANT	
	(user inserts own data and options)			
Cleaning agent price	1.10	£/kg	1.10	£/kg
Cleaning agent conc. in tank	80	g/litre	80	g/litre
Soak tank temperature, deg °C	80	deg °C	80	deg °C
evaporation loss	49.3	litre/h	49.3	litre/h
+ drag out*	20.0	litre/h	20.0	litre/h
= make-up water req'd	69.3	litre/h	69.3	litre/h
No of rinse tanks	2		4	
Rinse ratio required (min)	2 000		2 000	
Minimum rinse flow req'd	894.4	litre/h	133.7	litre/h
Actual rinse flow	894.4	litre/h	133.7	litre/h
Rinse flow to waste	825.1	litre/h	64.4	litre/h
Cost of water IN*	1 923	£/yr	288	£/yr
Cost of cleaning agent dragged out	4 988	£/yr	2 603	£/yr
Cost of effluent treatment	1 247	£/yr	651	£/yr
Cost of trade effluent discharge*	1 014	£/yr	79	£/yr
Total annual running costs	9 172	£/yr	3 621	£/yr
Annual savings			5 551	£/yr
Capital cost of additional tank(s)*			1 950	£
Payback period, at interest rate*		10 %	0.4	years
*rates and costs can be modified on the "Standards" or "Drag Out" pages				
(other values, automatically calculated)				

Figure 8.27: Alkaline cleaning station

This page allows data to be set for a specific plant for pickling, and a comparison against the modified plant to show costs for changes to this process and the payback period.

PICKLE	OWN PLANT	MODIFIED PLANT	
	(user inserts own data and options)		
Tank arrangement	3 tanks, batch	3 tanks in cascade	
Acid cost per year	£ 8 300	£/year	£ 5 534 £/year
Plant turnover	£ 1 660 000	£/year	£ 1 660 000 £/year
Reject rate, %	3.0	%	2.5 %
Proportion due to poor pickling	20	%	2.0 %
Value of poor pickling rejects	£ 9 960	£/year	£ 817 £/year
Cost savings due to improved pickling			£ 9 143 £/year
Acid cost savings			£ 2 766 £/year
Operating time saved by eliminating batch acid changes (3h)			£ 1 621 £/year
Annual savings			£ 13 530 £/year
Capital cost of modification			£ 500 £
Interest rate*			10 %
Payback period			0.0 years

**rates and costs can be modified on the "Standards" or "Drag-Out" pages*

Figure 8.28: Pickling station

This page allows data to be set for a specific plant for post-pickle rinsing, and a comparison against the modified plant to show costs for changes to this process and the payback period. The rinse ratio required can be set.

RINSE 2 - AFTER PICKLE	OWN PLANT	MODIFIED PLANT
Operating hours per year*	3 072 h/year	3 072 h/year
Acid drag out rate*	20.0 litre/h	20.0 litre/h
	(user inserts own data and options)	
No of rinse tanks	2	3
Rinse ratio required (minimum)	2 000	2 000
Water consumption*	894.4 litre/h	252.0 litre/h
Cost of water IN*	1 923 £/yr	542 £/yr
Cost of trade effluent discharge*	1 099 £/yr	310 £/yr
Total annual running costs	3 022 £/yr	852 £/yr
Annual savings		2 170 £/yr
Capital cost of additional tank(s)*		1 300 £
Payback period, at interest rate*	10 %	0.6 years
	<i>*rates and costs can be modified on the "Standards" or "Drag-Out" pages</i>	

Figure 8.29: Post-pickle rinsing; comparison of operation and costs for average and good practice plants and payback period.

This page allows data to be set for a specific plant for electrocleaning, and a comparison against the modified plant to show costs for changes to this process and the payback period. The rinse ratio required can be set.

ELECTROCLEANING STATION	OWN PLANT		MODIFIED PLANT (user inserts own data and options)	
	Cleaning agent price	1.10	£/kg	1.10
Cleaning agent conc. in tank	80	g/litre	80	g/litre
Soak tank temperature, deg °C	80	deg °C	80	deg °C
evaporation loss	24.7	litre/h	24.7	litre/h
No of rinse tanks	3		4	
Rinse ratio required (minimum)	2 000		2 000	
Minimum rinse flow req'd	252.0	litre/h	133.7	litre/h
Actual rinse flow	252.0	litre/h	133.7	litre/h
Rinse flow to waste	227.3	litre/h	109.1	litre/h
Cost of water IN*	542	£/yr	288	£/yr
Cost of cleaning agent dragged out	4 877	£/yr	4 409	£/yr
Cost of effluent treatment	1 219	£/yr	1 102	£/yr
Cost of trade effluent discharge*	279	£/yr	134	£/yr
Total annual running costs	6 917	£/yr	5 933	£/yr
Annual savings			984	£/yr
Capital cost of additional tank(s)*			1 300	£
Payback period, at interest rate*		10%	1.5	years

**rates and costs can be modified on the "Standards" or "Drag-out" pages*

Figure 8.30: Electrocleaning station

This page allows data to be set for a specific plant for electroplating, and a comparison against the modified plant to show costs for changes to this process and the payback period. The rinse ratio required can be set.

PLATE	OWN PLANT	MODIFIED PLANT
Whether evaporator installed.....	No	Yes
No of rinse stages	3	5
Rinse ratio required [minimum]	3 000	3 000
Rinse flow required	288.4 litre/h	99.2 litre/h
Evaporator rating		99.2 litre/h
Effluent flow	288.4 litre/h	0.0 litre/h
Running costs: chemicals	10 721 £ pa	0 £ pa
water IN	620 £ pa	213 £ pa
effluent treatment	2 680 £ pa	0 £ pa
trade effluent discharge	354 £ pa	0
chiller/evaporator operation	1 769 £ pa	1 352 £ pa
Total running costs	16 144 £ pa	1 565 £ pa
Annual savings		14 579 £ pa
Capital cost of extra tank(s) & evaporator		16 950 £
Interest rate*		10 %
Payback period		1.3 years
<i>*Rates can be changed: see Standards sheet</i>		

Figure 8.31: Plating station and rinses

This page calculates requirements for chillers, and specific data can be entered. The software automatically calculates costs and also calculates the cost of the option to use an evaporator to balance the rinse return.

Plating Tanks Heat Balance - Chiller Option		Heat Balance	
(user inserts own data)		(calculated by spreadsheet)	
Plating voltage	12	Vdc	
Plating current per stage	1 500	A/stage	
No of plating stages	5		
Utilisation factor	80	%	
Heat from plating operation			
Natural heat losses	50	% of plating	72 kW
Balance to be removed by chiller			- 36 kW
			36 kW
Chiller coefficient	40	%	kW
Ancilliary equipment power	14		
		Annual running costs*:	1 769 £/yr
		(annual cost of plating current:	9 830 £/yr
Plating Tanks Heat Balance - Evaporator Option			
Evaporator design rate	99	litre/h	
Evaporation characteristic	0.7	kW/litre/h	
Heat loss through evaporation			- 69 kW
Heat gain from plating (see above)			72 kW
Natural heat losses (see above)			- 36 kW
Balance to be supplied by hot water coils			- 33 kW
		kW	
HW heating required	33		

Figure 8.32: Chiller requirements of plating station

Again, this allows the number of rinses and rinse ratio for a specific plant to be entered and compared with an optimised plant.

RINSE 4 - AFTER PASSIVATE	OWN PLANT	MODIFIED PLANT
Operating hours per year*	3 072 h/year	3 072 h/year
Acid drag out rate*	20.0 litre/h	20.0 litre/h
	(user inserts own data and options)	
No of rinse tanks	2	3
Rinse ratio required (minimum)	5 000	5 000
Water consumption*	1414.2 litre/h	342.0 litre/h
Cost of water IN*	3 041 £/yr	735 £
Cost of trade effluent discharge*	1 738 £/yr	420 £
Total annual running costs	4 779 £/yr	1 155 £
Annual savings		3 624 £
Capital cost of additional tank(s)*		1 300 £
Payback period, at interest rate*	10 %	0.4 years
<i>*rates and costs can be modified on the "Standards" or "Drag-out" pages</i>		

Figure 8.33: After passivation rinsing

8.12 Example calculation of the cost benefit of reducing NO_x emissions from aluminium brightening

Description

Example facility with automatic/semi-automatic brightening of aluminium prior to anodising. Processing line is alkaline soak clean/degrease; brightener; hot smut removal; anodising, with rinses between:

- brightening solution 6 – 7 % of 70 % nitric acid (as supplied)
- 15 % sulphuric acid (supplied as 96 %)
- 78 – 79 % phosphoric acid (supplied as 50 %).

Air is extracted at 30000 m³/h through a scrubber. Most NO₂ is absorbed, leaving mainly NO which is more difficult.

Achieved environmental benefits

Typical industry figures for NO_x emitted after scrubbing 60 – 70 mg/m³

Provisional Environment Agency for England and Wales draft guidance (2001) sets benchmark value for NO_x of 20 mg/m³. To decrease emission to proposed benchmark requires reduction of 50 mg/m³.

30000 m³ x 50 mg = 1500 g per hour.

For an operation running 24 hours a day, 360 day a year (assuming shift working or need to keep SCR running while tanks are hot):
= 12960 kg/yr ≈ 13 tonnes NO_x/yr

For an operation running 8 hours a day, 5 days a week, 48 weeks:
= 12 kg/d = 60 kg/wk = 2880 kg/yr ≈ approximately 3 tonnes NO_x/yr.

Cross-media effects

Power consumption.

Materials and chemicals used in process, especially catalysts.

Operational data

See above.

Economics and applicability

Scale factor (from the first draft reference document on BAT on Economics and Cross-media effects) i.e. scaling the cost from an actual plant using the technique:

$$C_y = C_x (y/x)^e$$

Where C_y = cost of plant y

C_x = cost of plant x

y = scale of plant y (size or throughput)

x = scale of plant x (size or throughput)

e = rough approximation factor, 0.6 being taken as roughly correct when using throughput as the scaling parameter

In this case:

$$C_y = C_x(30000/110000)^{0.6} C_x(0.273)^{0.6} = \text{EUR } 459000 \sim \text{EUR } 500000$$

	Nitric acid plant	Aluminium Brightening	
Investment excluding catalyst	925000	500000	750000
Cost per year over 15 years	95400	51500	76500
Maintenance and wear (2 % of capital)	18500	10000	14250
Additional energy	3710	1830	2720
SCR cost per year	8300	3000?	5000?
Liquid ammonia	35000	2000?	3000?
<i>Total annual running costs</i>	65510	14800	20970
<i>Annual total costs</i>	(sic)164400	78130	114440
Cost per tonne NO _x abated	593	5275 to 22783	7805 to 33823
Shadow cost of NO _x per tonne		1500 to 7100	
EU-15 average		4200	
Note: ? = guesstimate in lieu of real data			

Table 8.47: Selective catalytic reduction (SCR) of NO_x: Cost in EUR (2001)
Data from [24, UBA-Austria, 2001]

Economic viability

Gross profit in 1996 in EU manufacturing: ~9 %, now <5 % and will be for 2 – 4 years.

SME turnover EUR 7 million, gross profit at 5 % = EUR 350000

But most SMEs in this sector have a turnover of about EUR 1.5 million, with a capitalisation per company of about EUR 1.5 million, and a gross profit at 5 % = EUR 75000.

Conclusions for this example

For over 90 % of the industry as SMEs, even at the top end of SME size and profitability, the cost of installation is disproportionate. For most SMEs the cost is not sustainable.

The cost of abatement per tonne of NO_x is at best 1.2 times the EU shadow cost of NO_x, as an average 5 times, and at worst is 8 times the EU shadow cost of NO_x.

Driving force for implementation

Large NO_x emissions.

Local environmental air quality issues.

References

[29, EA, 2001-3] [24, UBA-Austria, 2001] [88, EIPPCB,].

Data on brightening aluminium, personal communications, David Hemsley, CETS.

File note calculation of NO_x emissions from aluminium brightening [153, Tempany, 2003].

8.13 Waste water minimisation and waste water-free electroplating in Germany

Water is an indispensable raw material for industrial production. In Germany as in many other countries, fresh water and the purification and discharge of waste water are a substantial cost factor for many branches. Cost reduction was the main reason that water saving techniques were introduced to almost all industries in Germany.

The total cost for the use of water in industry are made up of the following costs:

- purchase of fresh water
- treatment of fresh water, if necessary
- cleaning of waste water
- waste water discharge fee
- control (sampling, monitoring)
- disposal of the waste generated in waste water purification.

The factors affecting water costs differ strongly, depending on type of use, regional water supply and legal standards. In Germany the total costs for the industrial use of water can be as high as EUR 50/m³. Waste water treatment is usually the largest cost factor. The cost of waste water treatment is determined on one hand by the nature and quantity of the pollutants and on the other hand by differentiated administrative rules depending on the quality of the waste water. The requirements for the discharge of waste water to drain have been standardised within the European Union and international standards can be seen in Annex 8.3.

Basis of waste water free technology

An important prerequisite for the introduction of waste water free technology is the installation of a purification unit in order to regain the water's original quality. The costs for such a purification stage are usually high, but on the other hand the costs for conventional water use are not incurred. In order to evaluate whether the closing of the water cycle is economically favourable or not, the following conditions must be considered:

- total amount of waste water
- requirements on the quality of the recirculated water
- nature and quantity of the pollutants
- losses from the cycle by discharge and evaporation.

In practice, there are different types of waste water pollutants, some are easy to remove while others are difficult to remove.

Pollutants that are easy to remove:

- biodegradable organic compounds
- metal ions which can be precipitated
- solids easy to filtrate
- inorganic compounds which can easily be destroyed (cyanide, nitrate, ammonia).

Pollutants that are difficult to remove:

- salts
- fine dispersions of solids (colloids)
- stable organic and inorganic compounds.

All these variables must be considered when calculating the cost of production without producing waste water. The decision as to whether or not a process without waste water should be introduced is dominated by the cost benefits, where:

- the purchase of fresh water, waste water purification, the waste water discharge fee, and controls.

is larger than

- the costs for the water recirculation system.

Particularly in Europe, the operation of systems without waste water in plating shops is economically viable only under specific conditions, as shown by the examples, below.

Waste water contains substances, in particular salts, which are difficult to remove from the waste water; the only available technique is an evaporation process. Since the evaporation of water is an expensive process, this technology is used only in exceptional cases.

For all examples presented in the following, it must be taken into consideration that they reflect German conditions. The costs of fresh water, waste water discharge and environmental regulations are substantial:

- | | |
|------------------------------------|--------------------------|
| • fresh water | EUR 1 – 2/m ³ |
| • discharge of waste water | EUR 2 – 4/m ³ |
| • waste disposal | EUR 100 – 200/t |
| • controls (sampling and analyses) | EUR 5000 – 10000/yr. |

Regulations (e.g. German Waste Water Ordinance, IPPC Directive)

- require an economical use of water
- compliance with the limit values for the discharge of waste water.

Technical solutions which are economically viable in Germany may not necessarily be so under different conditions in other countries.

Conventional waste water minimised technology

Due to the high costs for fresh water and waste water (EUR 3 – 8/m³), and legal standards requiring an economical use of water, water consumption in the German plating industry has dropped dramatically over the last 10 years. Large plating shops, for instance, have reduced their total waste water emission from 30000 – 50000 m³/yr to a few 1000 m³/yr.

Plant A

In the first design phase of this plant, thought was given to implementing a waste water free production process. Although it is possible to run individual process stages almost without generating any waste water, it became evident in the course of the planning process that the construction of a completely waste water free production plant would not be compatible with the requirement of an energetically optimised process, especially if no excess heat from other production processes can be used. The calculations also proved that the waste water free alternative would be too expensive compared to a waste water minimised technique. In consequence, the concept was changed to minimise the generation of waste water. The new plant with a plating capacity of 400000 m²/yr only produces 1215 m³ of waste water per year (that means a specific rinse-water consumption of 3 l/m²).

The basic condition for a water-saving technology was the installation of an optimal rinsing system. Wherever technically possible, three step rinses were installed. The rinse-water from the passivating line is purified by ion exchangers and fed back to the rinse. The only waste water from the passivating line comes from the regeneration of the ion exchangers. The rinse-water from the plating process is concentrated by an evaporator unit and completely returned to the process, while the distillate is used again for rinsing. The layout of the complex and expensive waste water treatment unit necessary to meet the strict German standards can be kept substantially smaller, which compensates the additional costs of the water saving technology.

Waste water free process stages

As mentioned earlier, operation of an entire plant free of waste water is generally not acceptable from a financial standpoint. Under certain circumstances, however, it can be favourable to operate certain process stages without producing waste water. This requires the waste water from process stages to be collect and treated separately.

Plant B

Plant B was a project, supported by the German Environment Ministry, to retrofit a 15 year old chromium plating plant with waste and waste water -free technology. The old plant was equipped with a standard three-step rinse, and electrical cooling systems were used to eliminate the process heat. Of the 60 tonnes of chromic acid used yearly in this plant, about 23 tonnes ended up in waste water, resulting in about 500 tonnes of electroplating sludge.

The concept of the new plant is based on using the evaporation heat to accomplish the necessary cooling of the electrolyte. For this purpose the water of the first static rinse is fed to a vaporiser, which also serves to demist the exhaust air from the process bath. The vaporisation of the water causes the diluted electrolyte to be cooled and concentrated so that it can be returned to the process bath. The rinsing technique for the process, a five-stage combined dip and spray rinsing system, is so designed that the required amount of rinse-water is exactly the same as the amount vaporised. This means that the electrolyte cycle and the water cycle are closed and no waste and no waste water are generated by the plant during normal operation.

The electrolytes are regenerated by electrodialysis. Here the reduced trivalent chromium is re-oxidised to hexavalent chromium, and cations such as iron, copper and zinc, which adversely affect the chromium plating process, are removed selectively. The electroplating process itself is waste water free. Small amounts of waste water arise in cleaning operations and in the regeneration of the electrolytes. The amount of waste generated in the treatment of waste water from these sources comes to only 7 t/yr, as opposed to more than 500 t generated yearly before the plant was retrofitted.

The waste water free technology has substantial economic advantages over the conventional technology, as the following numbers demonstrate. The complete return of dragged out process solution to the process tank eliminates the costs of the purchase of 23 t of chromic acid per year, and along with this, chemical costs for the treatment of waste water containing chromate at a value of EUR 25000/yr as well as costs for the disposal of electroplating sludge (500 t/yr) to the tune of EUR 75000/yr. The waste water free technology resulted in water cost savings of approximately EUR 300000/yr. The savings in operating costs led the investment paying for itself within one year.

Waste water free production plant

As described above and in Section 4.7.11, it can be economical to run individual stages of an electroplating plant waste water free. In order to operate an entire waste water-free plant under economically viable conditions, several conditions have to be met, as shown in the example plant, below.

Plant C

The plant is an in-house plating shop with only a few process stages and a uniform spectrum of workpieces (screws and nuts). Surplus heat is available from the in-house hardening plant. The plant is situated in a drinking water catchment area. In Germany, plants which use water-polluting materials are not normally permitted to operate in such areas. The task, therefore, was to build an economically viable plant which generated no waste water whatsoever. The key to the economically viable introduction of this technology is mainly an economical use of water. For this reason specific attention was paid to the rinsing stages and the recycling of dragged-out liquids.

Water saving rinsing:

- all process stages were fitted with multistage (minimum of three stages) water saving cascade rinses
- at the zinc plating bath a six-stage rinse was installed, which was designed as a compact rinse
- installation of ion exchangers after the flow rinses.

Feedback of drag-out:

- direct return of the rinse-water at all hot working stages
- concentration of the rinse-water from the zinc plating unit by a vacuum evaporator and return of the concentrates to the process tank.

Due to these measures, water consumption could be reduced to approximately 1200 m³ per year, corresponding to 1300 l/h. This required evaporating 200 - 300 l/h during operation, leaving a waste water volume of approximately 1000 l/h. The waste water is neutralised with caustic soda solution, precipitating the major part of the heavy metals as hydroxide which can then be removed using a filter press. The neutralised waste water is concentrated in a low energy evaporator with vapour compression. The concentrate is dried and sent to an underground deposit facility.

The economic aspects of this plant are:

- Investment costs

The additional investment costs of EUR 500000 are mainly for the evaporator and the drier. Savings of approximately EUR 100000 arise because the waste water pretreatment plant is smaller and of a simpler design than the conventional treatment plant.

- Operating costs

The advantage of waste water free technology also lies in operating costs. Energy costs are kept low since surplus energy from the in-house hardening unit is used for the operation of the vaporiser and the drier. Savings of EUR 120000 are obtained by the considerably lower water consumption, no fees for waste water discharge, lower costs for waste water treatment chemicals and considerably lower waste disposal costs. The additional investment for the implementation of the waste water-free system will pay for itself within four years.

Reference literature

Economical and ecological aspects of water minimisation in electroplating shops and waste water-free electroplating have been evaluated in the two BMBF Joint Projects: "Conversion of plating shops to a material loss minimised process technology under simultaneous cost reduction" (FKZ 01RK9730/0; <http://www.10galvaniken.de/>) and "Closing materials circuits in the field of material removing wet processes" (FKZ 01ZH941B/1).