

JRC SCIENCE FOR POLICY REPORT

Best Available Techniques (BAT) Reference Document for the Non-Ferrous Metals Industries

*Industrial Emissions Directive
2010/75/EU
(Integrated Pollution
Prevention and Control)*

Gianluca Cusano, Miguel Rodrigo Gonzalo,
Frank Farrell, Rainer Remus, Serge Roudier,
Luis Delgado Sancho

2017



Best Available Techniques (BAT) Reference Document for the Non-Ferrous Metals Industries

Industrial Emissions Directive 2010/75/EU
Integrated Pollution Prevention and control

Authors:

Gianluca Cusano
Miguel Rodrigo Gonzalo
Frank Farrell
Rainer Remus
Serge Roudier
Luis Delgado Sancho

2017

This publication is a Science for Policy report by the Joint Research Centre, the European Commission's in-house science service. It aims to provide evidence-based scientific support to the European policy-making process. The scientific output expressed does not imply a policy position of the European Commission. Neither the European Commission nor any person acting on behalf of the Commission is responsible for the use which might be made of this publication.

Contact information

Name: European IPPC Bureau
Address: Joint Research Centre, Edificio Expo c/ Inca Garcilaso 3, E-41092 Seville, Spain
E-mail: JRC-B5-EIPPCB@ec.europa.eu
Tel.: +34 95 4488 284

JRC Science Hub

<https://ec.europa.eu/jrc>

JRC107041

EUR 28648 EN

PDF ISBN 978-92-79-69655-8 ISSN 1831-9424 doi:10.2760/8224

Luxembourg: Publications Office of the European Union, 2017

© European Union, 2017

Reproduction is authorised provided the source is acknowledged.

How to cite this report: Author(s); Gianluca Cusano, Miguel Rodrigo Gonzalo, Frank Farrell, Rainer Remus, Serge Roudier, Luis Delgado Sancho; Title; Best Available Techniques (BAT) Reference Document for the main Non-Ferrous Metals Industries, EUR 28648, doi:10.2760/8224

All images © European Union 2017, except: 1. Cover picture, credits: Sunndal aluminium smelter: © Hydro, 2. Landscape before landfilling © Asturiana de Zinc, S.A.U., 3. Landscape restoration ongoing with Jarofix © Asturiana de Zinc, S.A.U.

Title Best Available Techniques (BAT) Reference Document for the Non-Ferrous Metals Industries

Abstract:

The BAT reference document (BREF) entitled 'Non-Ferrous Metals Industries' forms part of a series presenting the results of an exchange of information between EU Member States, the industries concerned, non-governmental organisations promoting environmental protection, and the Commission, to draw up, review and, where necessary, update BAT reference documents as required by Article 13(1) of the Directive 2010/75/EU on industrial emissions. This document is published by the European Commission pursuant to Article 13(6) of the Directive. This BREF for 'Non-Ferrous Metals Industries' concerns the activities specified in Sections 2 and 6.8 of Annex I to Directive 2010/75/EU, namely:

- 2.1: Metal ore (including sulphide ore) roasting or sintering;
- 2.5: Processing of non-ferrous metals:
 - (a) production of non-ferrous crude metals from ore, concentrates or secondary raw materials by metallurgical, chemical or electrolytic processes;
 - (b) melting, including the alloyage, of non-ferrous metals, including recovered products and operation of non-ferrous metal foundries, with a melting capacity exceeding 4 tonnes per day for lead and cadmium or 20 tonnes per day for all other metals;
- 6.8: Production of carbon (hard-burnt coal) or electrographite by means of incineration or graphitisation.

This document also covers:

- the production of zinc oxide from fumes during the production of other metals;
- the production of nickel compounds from liquors during the production of a metal;
- the production of silicon-calcium (CaSi) and silicon (Si) in the same furnace as the production of ferro-silicon;
- the production of aluminium oxide from bauxite prior to the production of primary aluminium, where this is an integral part of the production of the metal;
- the recycling of aluminium salt slag.

Important issues for the implementation of Directive 2010/75/EU in the non-ferrous metals industries are the emissions to air of dust, metals, organic compounds (which can result in the formation of PCDD/F) and sulphur dioxide; diffuse air emissions; emissions to water of metals (e.g. Hg, Cd, Cu, Pb, Zn); resource efficiency; and the prevention of emissions to soil and groundwater. This BREF contains 12 chapters. Chapters 1 and 2 provide general information on the non-ferrous metals industry and on the common industrial processes and techniques used within the whole sector. Chapters 3, 4, 5, 6, 7, 8, 9 and 10 correspond to the following specific production sectors: copper, aluminium, lead and/or tin, zinc and/or cadmium, precious metals, ferro-alloys, nickel and/or cobalt, and carbon and graphite. For each specific production sector, these eight chapters provide information and data concerning the applied processes and techniques; the environmental performance of installations in terms of current emissions, consumption of raw materials, water and energy, and generation of waste; the techniques to prevent or, where this is not practicable, to reduce the environmental impact of operating installations in these sectors that were considered in determining the BAT; and the emerging techniques as defined in Article 3(14) of the Directive. Chapter 11 presents the BAT conclusions as defined in Article 3(12) of the Directive. Chapter 12 is dedicated to concluding remarks and recommendations for future work.

Printed in Ispra (Italy)

Acknowledgements

This report was produced by the European Integrated Pollution Prevention and Control Bureau (EIPPCB) at the European Commission's Joint Research Centre – Directorate B: Growth and Innovation under the supervision of Serge Roudier (Head of the EIPPCB) and Luis Delgado Sancho (Head of the Circular Economy and Industrial Leadership Unit).

The authors of this BREF were Gianluca Cusano, Miguel Rodrigo Gonzalo, Frank Farrell and Rainer Remus.

This report was drawn up in the framework of the implementation of the Industrial Emissions Directive (2010/75/EU) and is the result of the exchange of information provided for in Article 13 of the Directive.

Major contributors of information were:

- among EU Member States: Austria, Belgium, Finland, France, Germany, Greece, Italy, Poland, Portugal, Spain, Sweden, The Netherlands and the United Kingdom; Norway also provided valuable information.
- among industry: Association of European Ferro-alloy Producers (Euroalliages), European Aluminium Association (EAA), European association of mining industries, metal ores and industrial minerals (Euromines), European Carbon and Graphite Association (ECGA), European copper institute (ECI), European non-ferrous metals association (Eurometaux), European Precious Metals Federation (EPMF), International Lead Association (ILA), International Zinc Association (IZA), Nickel Institute.

The whole EIPPCB team provided contributions and peer reviewing.

This document is one from the series of documents listed below (at the time of writing, not all documents have been drafted):

Reference Document on Best Available Techniques	Code
Ceramic Manufacturing Industry	CER
Common Waste Gas Treatment in the Chemical Sector	WGC
Common Waste Water and Waste Gas Treatment/Management Systems in the Chemical Sector	CWW
Emissions from Storage	EFS
Energy Efficiency	ENE
Ferrous Metals Processing Industry	FMP
Food, Drink and Milk Industries	FDM
Industrial Cooling Systems	ICS
Intensive Rearing of Poultry and Pigs	IRPP
Iron and Steel Production	IS
Large Combustion Plants	LCP
Large Volume Inorganic Chemicals – Ammonia, Acids and Fertilisers	LVIC-AAF
Large Volume Inorganic Chemicals – Solids and Others industry	LVIC-S
Large Volume Organic Chemical Industry	LVOC
Management of Tailings and Waste-rock in Mining Activities	MTWR
Manufacture of Glass	GLS
Manufacture of Organic Fine Chemicals	OFC
<i>Non-ferrous Metals Industries</i>	<i>NFM</i>
Production of Cement, Lime and Magnesium Oxide	CLM
Production of Chlor-alkali	CAK
Production of Polymers	POL
Production of Pulp, Paper and Board	PP
Production of Speciality Inorganic Chemicals	SIC
Refining of Mineral Oil and Gas	REF
Slaughterhouses and Animals By-products Industries	SA
Smitheries and Foundries Industry	SF
Surface Treatment of Metals and Plastics	STM
Surface Treatment Using Organic Solvents including Wood Preservation with Chemicals	STS
Tanning of Hides and Skins	TAN
Textiles Industry	TXT
Waste Incineration	WI
Waste Treatment	WT
Wood-based Panels Production	WBP
Reference Document	
Economics and Cross-media Effects	ECM
Monitoring of emissions from IED-installations	ROM

Electronic versions of draft and finalised documents are publicly available and can be downloaded from <http://eippcb.jrc.ec.europa.eu>.

PREFACE

1. Status of this document

Unless otherwise stated, references to ‘the Directive’ in this document refer to Directive 2010/75/EU of the European Parliament and the Council on industrial emissions (integrated pollution prevention and control) (Recast).

The original best available techniques (BAT) reference document (BREF) on Non-ferrous metals was adopted by the European Commission in 2001. This document is the result of a review of that BREF. The review commenced in 2007.

This BAT reference document for the Non-ferrous metals industries forms part of a series presenting the results of an exchange of information between EU Member States, the industries concerned, non-governmental organisations promoting environmental protection and the Commission, to draw up, review and, where necessary, update BAT reference documents as required by Article 13(1) of the Directive. This document is published by the European Commission pursuant to Article 13(6) of the Directive.

As set out in Article 13(5) of the Directive, the Commission Implementing Decision (EU) 2016/1032 on the BAT conclusions contained in Chapter 11 was adopted on 13 June 2016 and published on 30 June 2016¹.

2. Participants in the information exchange

As required in Article 13(3) of the Directive, the Commission has established a forum to promote the exchange of information, which is composed of representatives from Member States, the industries concerned and non-governmental organisations promoting environmental protection (Commission Decision of 16 May 2011 establishing a forum for the exchange of information pursuant to Article 13 of the Directive 2010/75/EU on industrial emissions (2011/C 146/03), OJ C 146, 17.05.2011, p. 3).

Forum members have nominated technical experts constituting the technical working group (TWG) that was the main source of information for drafting this document. The work of the TWG was led by the European IPPC Bureau (of the Commission's Joint Research Centre).

3. Structure and contents of this document

The production of 42 non-ferrous metals and the production of ferro-alloys were identified in countries that are obliged to implement the IED. Eight groups of metals with similar production methods were identified. The study gathered data on the basis of these groups and this document is structured on this basis. It also takes into account that the process is of major industrial importance within the NFM sector and has the potential for environmental issues, and the information exchange has been particularly valuable for operators and regulators.

The metal groups are:

- copper and its alloys;
- aluminium and its alloys and the recycling of salt and aluminium from salt slags;
- lead and tin;
- zinc and cadmium;
- precious metals;
- ferro-alloys (e.g. FeCr, FeSi, FeMn, SiMn, FeTi, FeMo, FeV, FeB);

¹ OJ L 174, 30.6.2016, p. 32.

- nickel and cobalt;
- carbon and graphite electrodes.

In more detail, the NFM BREF has the following structure.

Chapter 1 provides general information on the non-ferrous metals industries concerned. Chapter 2 provides information on the common industrial processes, abatement systems and general techniques that are used across the sector. General techniques to consider in the determination of BAT (i.e. those techniques to consider that are widely applied in this sector) are reported in Chapter 2, and Chapters 3 to 10 give the applied processes, current emission and consumption levels, techniques to consider in the determination of BAT and emerging techniques for the metal groups that are represented by these chapters. Chapter 11 presents the BAT conclusions as defined in Article 3(12) of the Directive, both general and metal-specific.

For each of the Chapters 3 to 10, data are provided for the group of metals in that chapter according to the following structure.

Section 1 describes the applied processes and techniques used for the particular group of metals.

Section 2 provides data and information concerning current emission and consumption levels, reflecting the situation in existing installations.

Section 3 describes in more detail the techniques to prevent or, where this is not practicable, to reduce the environmental impact of installations in this sector that were considered in determining the BAT. This information includes, where relevant, the environmental performance levels (e.g. emission and consumption levels) which can be achieved by using the techniques, the associated monitoring and the costs and the cross-media issues associated with the techniques.

Section 4 presents information on 'emerging techniques' as defined in Article 3(14) of the Directive.

Concluding remarks and recommendations for future work are presented in Chapter 12.

4. Information sources and the derivation of BAT

This document is based on information collected from a number of sources, in particular through the TWG that was established specifically for the exchange of information under Article 13 of the Directive. The information has been collated and assessed by the European IPPC Bureau (of the Commission's Joint Research Centre) who led the work on determining BAT, guided by the principles of technical expertise, transparency and neutrality. The work of the TWG and all other contributors is gratefully acknowledged.

The BAT conclusions have been established through an iterative process involving the following steps:

- identification of the key environmental issues for the non-ferrous metals sector;
- examination of the techniques most relevant to address these key issues;
- identification of the best environmental performance levels, on the basis of the available data in the European Union and worldwide;
- examination of the conditions under which these environmental performance levels were achieved, such as costs, cross-media effects, and the main driving forces involved in the implementation of the techniques;
- selection of the best available techniques (BAT), their associated emission levels (and other environmental performance levels) and the associated monitoring for this sector according to Article 3(10) of, and Annex III to, the Directive.

Expert judgement by the European IPPC Bureau and the TWG has played a key role in each of these steps and the way in which the information is presented here.

Where available, economic data have been given together with the descriptions of the techniques presented in the sections on 'Techniques to consider in the determination of BAT'. These data give a rough indication of the magnitude of the costs and benefits. However, the actual costs and benefits of applying a technique may depend strongly on the specific situation of the installation concerned, which cannot be evaluated fully in this document. In the absence of data concerning costs, conclusions on the economic viability of techniques are drawn from observations on existing installations.

The production of sulphuric acid from non-ferrous metals industries is within the scope of the LVIC-AAF BREF. However, this NFM BREF review has also gathered information on the techniques applied by NFM industries to produce sulphuric acid too. The outcome of this data collection is shown mainly in Chapters 2, 3, 5 and 6 of this document and it has become apparent that the upper end of the BAT-AEL range for SO₂ emissions from the production of sulphuric acid in a double contact/double absorption plant in Table 4.24 'Conversion rates and SO₂ emission levels associated with BAT' in the LVIC-AAF BREF (adopted in 2007) needs to be corrected.

5. Review of BAT reference documents (BREFs)

BAT is a dynamic concept and so the review of BREFs is a continuing process. For example, new measures and techniques may emerge, science and technologies are continuously developing and new or emerging processes are being successfully introduced into the industries. In order to reflect such changes and their consequences for BAT, this document will be periodically reviewed and, if necessary, updated accordingly.

6. Contact information

All comments and suggestions should be made to the European IPPC Bureau at Joint Research Centre (JRC) at the following address:

European Commission
JRC Directorate B - Growth and Innovation
European IPPC Bureau
Edificio Expo
c/ Inca Garcilaso, 3
E-41092 Seville, Spain
Telephone: +34 95 4488 284
Fax: +34 95 4488 426
E-mail: JRC-B5-EIPPCB@ec.europa.eu
Internet: <http://eippcb.jrc.ec.europa.eu>

Best Available Techniques Reference Document for the Non-Ferrous Metals Industries

PREFACE	I
SCOPE	XLIII
1 GENERAL INFORMATION	1
1.1 INDUSTRY OVERVIEW.....	1
1.1.1 Non-ferrous metals and alloys	1
1.1.2 Scope of the industry	1
1.1.3 Structure of the industry	2
1.1.4 Economics of the industry	2
1.1.5 Environmental performance	3
1.2 COPPER AND ITS ALLOYS	4
1.2.1 General information.....	4
1.2.2 Sources of materials.....	4
1.2.3 Production and use.....	5
1.2.4 Production sites.....	8
1.2.5 Key environmental issues	10
1.3 ALUMINIUM.....	11
1.3.1 General information.....	11
1.3.2 Sources of materials.....	11
1.3.3 Production and use.....	11
1.3.4 Production sites.....	13
1.3.5 Key environmental issues	13
1.4 LEAD AND TIN	14
1.4.1 Lead	14
1.4.1.1 General information.....	14
1.4.1.2 Sources of materials.....	15
1.4.1.3 Production and use.....	15
1.4.1.4 Production sites.....	15
1.4.1.5 Key environmental issues	17
1.4.2 Tin.....	18
1.4.2.1 General information.....	18
1.4.2.2 Sources of material	18
1.4.2.3 Production and use.....	19
1.4.2.4 Production sites.....	19
1.4.2.5 Key environmental issues	20
1.5 ZINC AND CADMIUM.....	21
1.5.1 Zinc	21
1.5.1.1 General information.....	21
1.5.1.2 Sources of materials.....	22
1.5.1.3 Production and use.....	22
1.5.1.4 Production sites.....	24
1.5.1.5 Key environmental issues	25
1.5.2 Cadmium.....	25
1.5.2.1 General information.....	25
1.5.2.2 Source of materials	25
1.5.2.3 Production and use.....	26
1.5.2.4 Production sites.....	27
1.5.2.5 Key environmental issues	28
1.6 PRECIOUS METALS.....	29

1.6.1	General information	29
1.6.2	Sources of materials	29
1.6.3	Production and use	30
1.6.4	Production sites	31
1.6.5	Environmental issues.....	31
1.7	FERRO-ALLOYS	32
1.7.1	General information	32
1.7.2	Sources of materials	32
1.7.3	Production and use	33
1.7.4	Production sites	35
1.7.5	Key environmental issues.....	36
1.8	NICKEL AND COBALT	37
1.8.1	Nickel	37
1.8.1.1	General information	37
1.8.1.2	Sources of materials	37
1.8.1.3	Production and use	38
1.8.1.4	Production sites	39
1.8.1.5	Key environmental issues.....	40
1.8.2	Cobalt	41
1.8.2.1	General information	41
1.8.2.2	Sources of materials	41
1.8.2.3	Production and use	42
1.8.2.4	Production sites	43
1.8.2.5	Key environmental issues.....	43
1.9	CARBON AND GRAPHITE	44
1.9.1	General information	44
1.9.2	Sources of materials	44
1.9.3	Production and use	45
1.9.4	Production sites	45
1.9.5	Key environmental issues.....	46
2	GENERAL PROCESSES AND TECHNIQUES	47
2.1	MANAGEMENT SYSTEMS	49
2.1.1	Management policy and commitment	49
2.1.2	Design and maintenance.....	50
2.1.3	Training	50
2.2	ENERGY MANAGEMENT	51
2.2.1	Applied processes and techniques.....	51
2.3	MONITORING	55
2.3.1	Sampling locations	55
2.3.2	Components and parameters	56
2.3.3	Reference conditions	56
2.3.4	Continuous and periodic measurement of channelled emissions	56
2.3.5	Diffuse emissions measurement.....	57
2.4	DIFFUSE EMISSIONS	60
2.4.1	Sources of diffuse emissions	60
2.4.2	Applied processes and techniques to prevent diffuse emissions from storage and handling of input materials	61
2.4.2.1	Applied processes and techniques for ores and concentrates	61
2.4.2.2	Applied processes and techniques for secondary raw materials.....	63
2.4.2.3	Applied processes and techniques for fuels.....	63

2.4.2.4	Applied processes and techniques for process chemicals and gases.....	65
2.4.3	Applied processes and techniques to prevent diffuse emissions and collect off-gases from metal production processes.....	66
2.5	RAW MATERIAL MANAGEMENT	68
2.5.1	Applied processes and techniques	68
2.5.1.1	Thawing	68
2.5.1.2	Drying.....	68
2.5.1.3	Crushing, size reduction and screening	69
2.5.1.4	Battery breaking	69
2.5.1.5	Blending	69
2.5.1.6	Briquetting, pelletising and other agglomeration methods	70
2.5.1.7	Sintering and calcination	70
2.5.1.8	Fuming processes	71
2.5.1.9	Decoating and de-oiling.....	71
2.5.1.10	Incineration and pyrolysis.....	71
2.5.1.11	Leaching and washing procedures	72
2.5.1.12	Separation techniques	72
2.5.1.13	Transfer and charging systems	73
2.6	METAL PRODUCTION PROCESSES	74
2.7	SULPHUR DIOXIDE.....	75
2.7.1	Applied processes and techniques	75
2.7.2	Current emission and consumption levels	80
2.8	WATER AND WASTE WATER MANAGEMENT.....	85
2.8.1	Main sources of liquid effluent.....	85
2.8.1.1	Effluents from off-gas cleaning	86
2.8.1.2	Effluent from matte or slag granulation and the production of metal shot and density separation	87
2.8.1.3	Cooling water	88
2.8.1.4	Surface run-off water	89
2.8.1.5	Effluents from the hydrometallurgical process	89
2.8.1.6	Other process waters.....	90
2.8.1.7	Miscellaneous sources	91
2.8.2	Applied processes and techniques	91
2.9	RESIDUE MANAGEMENT	92
2.9.1	Applied processes and techniques for residues from the smelting process	93
2.9.2	Applied processes and techniques for residues from abatement systems	95
2.9.3	Applied processes and techniques for residues from liquid effluent treatment ..	96
2.9.4	Applied processes and techniques for residues from the non-ferrous metals hydrometallurgical processes.....	96
2.9.5	Applied processes and techniques for other residues from the production of non-ferrous metals	97
2.9.6	Examples of recycling and reuse	97
2.10	DECOMMISSIONING	100
2.11	SAFETY ISSUES	101
2.11.1	Prevention principle.....	101
2.11.2	Consideration of complex systems in process industries.....	101
2.11.3	Appropriateness of means.....	101
2.12	GENERAL TECHNIQUES TO CONSIDER IN THE DETERMINATION OF BAT	102
2.12.1	Environmental management systems.....	102
2.12.2	Energy management	105
2.12.2.1	Use of oxygen enrichment in combustion air	105
2.12.2.2	Use of a regenerative burner.....	107

2.12.2.3	Use of a regenerative afterburner	109
2.12.2.4	Use of low-grade heat	110
2.12.2.5	Use of waste as a fuel or reducing agent	112
2.12.3	Monitoring and process control.....	113
2.12.3.1	Process control techniques	113
2.12.3.2	Design and control techniques for an abatement plant.....	115
2.12.3.3	Process control techniques for effluent treatment	117
2.12.4	Diffuse emissions	118
2.12.4.1	Techniques to prevent diffuse emissions from raw material storage, handling and transport.....	118
2.12.4.2	Techniques to prevent diffuse emissions from the pretreatment of raw materials	121
2.12.4.3	Techniques to prevent diffuse emissions and collect off-gases from metal production processes	122
2.12.5	Channelled emissions to air.....	128
2.12.5.1	Techniques to reduce dust, metal and particle emissions	128
2.12.5.1.1	Electrostatic precipitators	128
2.12.5.1.2	Wet electrostatic precipitator.....	130
2.12.5.1.3	Cyclones	132
2.12.5.1.4	Fabric or bag filters	133
2.12.5.1.5	Ceramic and metal mesh filters	138
2.12.5.1.6	Wet dust scrubber	140
2.12.5.1.7	Overview of dust abatement techniques	142
2.12.5.2	Techniques to reduce gaseous compounds emissions	143
2.12.5.2.1	Afterburners/Afterburning chambers	143
2.12.5.2.2	Wet gas scrubber	145
2.12.5.2.3	Dry and semi-dry scrubbers	146
2.12.5.2.4	Gas recovery systems	147
2.12.5.2.5	Oxy-fuel firing.....	148
2.12.5.2.6	Techniques to remove hydrocarbons and VOCs	150
2.12.5.2.7	Removal of other impurities.....	151
2.12.5.2.7.1	Other metals	151
2.12.5.3	Techniques to reduce PCDD/F emissions	152
2.12.5.4	Techniques to reduce sulphur dioxide emissions	155
2.12.5.4.1	Double contact/double absorption sulphuric acid plants operating under varying gas conditions.....	155
2.12.5.4.2	Upgraded sulphuric acid plants with lower SO ₂ inlet concentration variations associated with non-ferrous metal production	158
2.12.5.4.3	Production of liquid sulphur dioxide from off-gases with a high SO ₂ content	160
2.12.5.4.4	Use of flue-gas desulphurisation for off-gases with a low SO ₂ content	162
2.12.5.4.5	Polyether-based absorption/desorption process for sulphur capture from off-gases with a low SO ₂ content (< 1 %)	163
2.12.5.5	Techniques to reduce mercury emissions.....	164
2.12.6	Water and waste water management	168
2.12.6.1	Process-integrated measures	168
2.12.6.2	Waste water treatment techniques.....	171
2.12.6.2.1	Chemical precipitation	174
2.12.6.2.2	Treatment of weak acid and process water.....	176
2.12.6.2.3	Biological treatment	179
2.12.6.2.4	Sedimentation and flotation.....	180
2.12.6.2.5	Filtration.....	181
2.12.6.2.6	Electrolysis.....	182
2.12.6.2.7	Reverse osmosis	183
2.12.6.2.8	Ion exchange	184
2.12.6.2.9	Activated carbon	185
2.12.7	Residues management	186
2.12.8	Noise and vibration	188

2.12.9	Odour	188
2.12.10	Decommissioning	189
2.13	EMERGING TECHNIQUES.....	192
2.13.1	The LUREC and BAYQIK processes.....	192
3	PROCESSES TO PRODUCE COPPER AND ITS ALLOYS FROM PRIMARY AND SECONDARY RAW MATERIALS	195
3.1	APPLIED PROCESSES AND TECHNIQUES.....	195
3.1.1	Primary copper production	195
3.1.1.1	The pyrometallurgical route.....	195
3.1.1.1.1	Concentrate to matte smelting	195
3.1.1.1.2	Converting	200
3.1.1.1.3	Fire refining (anode furnace)	202
3.1.1.1.4	Electrolytic refining	203
3.1.1.1.5	Treatment of copper-rich slags	204
3.1.1.2	The hydrometallurgical route.....	205
3.1.2	Secondary copper production	206
3.1.2.1	Secondary copper smelting stage.....	207
3.1.2.2	Converting, fire refining, slag treatment and the electrorefining and processing of pure alloy scrap	207
3.1.3	Wire rod production.....	209
3.1.3.1	Southwire process	209
3.1.3.2	Contirod process	211
3.1.3.3	Properzi and Secor processes.....	211
3.1.3.4	Upcast process	211
3.1.3.5	Dip-forming process	212
3.1.4	Production of semi-finished products of copper and copper alloys.....	212
3.1.4.1	Melting processes	213
3.1.4.2	Casting.....	213
3.1.4.3	Fabrication of tubes, sections and rods	215
3.1.4.4	Fabrication of sheets and strips.....	216
3.1.5	Production of copper and copper alloy ingots	217
3.1.5.1	Master alloys.....	218
3.1.6	Pickling operations	219
3.1.6.1	Non-acid pickling of copper rods	219
3.1.6.2	Acid pickling of copper rods and semis of copper and copper alloys.....	219
3.2	CURRENT EMISSION AND CONSUMPTION LEVELS	220
3.2.1	Energy consumption in copper production	220
3.2.2	Emissions and consumption data	221
3.2.2.1	Primary copper input and output	221
3.2.2.2	Secondary copper input and output data	223
3.2.2.3	Emissions to air	225
3.2.2.3.1	Carbon monoxide.....	226
3.2.2.3.2	Dust and metal compounds.....	227
3.2.2.3.3	Organic carbon compounds	229
3.2.2.3.4	PCDD/F	229
3.2.2.3.5	Sulphur dioxide.....	230
3.2.2.3.6	Diffuse emissions.....	231
3.2.2.3.7	Nitrogen oxides.....	232
3.2.2.3.8	Summary of emissions to air.....	232
3.2.2.4	Emissions to water.....	234
3.2.2.4.1	Suspended solids and metal compounds	235
3.2.2.4.2	Oil	237
3.2.2.5	Process residues	237
3.2.2.6	Operating data from some copper production processes	242

3.3	TECHNIQUES TO CONSIDER IN THE DETERMINATION OF BAT	248
3.3.1	Material reception, storage and handling processes	248
3.3.1.1	Techniques to reduce diffuse emissions from reception, storage and handling of primary and secondary materials	248
3.3.1.2	Techniques to reduce diffuse emissions from the transport of fine and dusty materials	251
3.3.2	Material pretreatment processes	253
3.3.2.1	Techniques to prevent and reduce emissions from the pretreatment of primary and secondary materials such as blending, drying, mixing, homogenisation, screening and pelletisation	253
3.3.2.2	Techniques to remove oil from turnings before the melting stage in secondary copper production	258
3.3.2.3	Techniques to reduce emissions from concentrate drying	260
3.3.2.4	Techniques to reduce primary off-gas emissions from copper concentrate roasting	264
3.3.3	Primary and secondary copper production	266
3.3.3.1	Techniques to prevent and reduce emissions from the charging of furnaces/converters in primary and secondary copper production	266
3.3.3.2	Techniques to prevent and reduce emissions to air from smelting furnaces in primary copper production	268
3.3.3.3	Techniques to prevent and reduce emissions from converter furnaces in primary copper production	276
3.3.3.4	Copper-rich slag processing	283
3.3.3.4.1	Techniques to prevent and reduce emissions from copper-rich slag processing by slow-cooling, crushing, milling and flotation (slag concentrator)	283
3.3.3.4.2	Techniques to prevent and reduce emissions from copper-rich slag furnace treatment (electric furnace or slag fuming)	286
3.3.3.5	Techniques to prevent and reduce emissions from melting and fire refining (anode furnace) in primary and secondary copper production	291
3.3.3.6	Centralised collection and abatement of secondary emissions from furnaces and auxiliary devices in primary copper production	299
3.3.3.7	Techniques to prevent and reduce emissions from anode casting in primary and secondary copper production	303
3.3.3.8	Optimised electrolysis in primary and secondary copper production	304
3.3.3.9	Sulphur dioxide removal from off-gases with a low SO ₂ content in primary and secondary copper production	309
3.3.3.10	Techniques to prevent and reduce emissions from the solvent extraction plant involved in hydrometallurgical copper production from concentrate or secondary materials	314
3.3.4	Secondary copper production	317
3.3.4.1	Techniques to prevent and reduce emissions to air from smelting furnaces in secondary copper production	317
3.3.4.1.1	Reduction of PCDD/F emissions by using primary and secondary measures in secondary copper production	325
3.3.4.1.2	Reduction of emissions from furnaces by using a regenerative afterburner in secondary copper production	327
3.3.4.1.3	Reduction of NO _x emissions from furnaces by using primary and secondary measures in secondary copper production	329
3.3.4.2	Techniques to prevent and reduce emissions to air from holding furnaces in secondary copper production	331
3.3.4.3	Techniques to prevent and reduce air emissions from converter furnaces in secondary copper production	333
3.3.4.4	Techniques to prevent and reduce secondary air emissions from auxiliary devices in secondary copper production	337
3.3.5	Copper processing	339
3.3.5.1	Techniques to reduce emissions from melting and casting for the production of copper and copper alloy formats, ingots and wire rods	339

3.3.5.2	Technique to prevent and reduce emissions from non-acid and acid pickling of copper rods and semis of copper and copper alloys.....	344
3.3.5.3	Techniques to prevent and reduce air emissions from lead and tin recovery from secondary copper intermediates	349
3.3.6	Waste water	350
3.3.6.1	Waste water prevention	350
3.3.6.2	Waste water treatment and reuse in primary and secondary copper production ...	352
3.3.7	Process residues	366
3.3.7.1	Use or treatment options for process residues	366
3.3.8	Energy.....	369
3.3.8.1	Technique to reduce energy consumption in primary copper production.....	369
3.3.8.2	Technique to reduce energy consumption in secondary copper production	372
3.4	EMERGING TECHNIQUES.....	375
4	PROCESSES TO PRODUCE ALUMINIUM FROM PRIMARY AND SECONDARY RAW MATERIALS INCLUDING THE PRODUCTION OF ALUMINA AND ANODES FABRICATED FOR ALUMINIUM PRODUCTION	377
4.1	APPLIED PROCESSES AND TECHNIQUES.....	377
4.1.1	Alumina	377
4.1.2	Anodes for aluminium production.....	379
4.1.3	Primary aluminium	383
4.1.3.1	Melting and molten metal treatment.....	386
4.1.3.2	Casting.....	387
4.1.4	Secondary aluminium	387
4.1.4.1	Production processes	387
4.1.4.1.1	Pretreatment.....	388
4.1.4.1.2	Melting process.....	389
4.1.4.1.3	Molten metal treatment and casting process	390
4.1.5	Salt slag.....	390
4.1.5.1	Salt slag recovery.....	391
4.2	CURRENT EMISSION AND CONSUMPTION LEVELS	392
4.2.1	Alumina	392
4.2.1.1	Emissions to air from alumina production.....	392
4.2.1.2	Red mud.....	392
4.2.1.3	Emissions to water.....	393
4.2.2	Anodes for aluminium production.....	393
4.2.2.1	Mass stream overview and input/output data.....	393
4.2.2.2	Emissions to air from anode production	393
4.2.2.2.1	VOCs, hydrocarbons and PAH.....	395
4.2.2.2.2	Dust.....	396
4.2.2.2.3	Combustion gases	396
4.2.2.2.4	Sulphur dioxide.....	396
4.2.2.2.5	Fluorides (anode production if anode butts are used)	396
4.2.2.2.6	PCDD/F	396
4.2.2.3	Emissions to water.....	396
4.2.2.4	Process residues	397
4.2.3	Primary aluminium	397
4.2.3.1	Mass stream overview and input/output data.....	397
4.2.3.2	Emissions to air	398
4.2.3.2.1	Capture of the gases	399
4.2.3.2.2	Fluorides	400
4.2.3.2.3	PFCs (polyfluorocarbons).....	401
4.2.3.2.4	Tar and PAH	401
4.2.3.2.5	Sulphur dioxide and sulphur compounds.....	402

4.2.3.2.6	Dust	403
4.2.3.2.7	Metals	404
4.2.3.2.8	Oxides of nitrogen	404
4.2.3.2.9	Carbon monoxide	404
4.2.3.2.10	Carbon dioxide	404
4.2.3.2.11	Summary of main air pollutants	404
4.2.3.3	Emissions to water	406
4.2.3.4	Process residues	406
4.2.3.4.1	Spent pot lining	407
4.2.3.4.2	Other materials	408
4.2.4	Secondary aluminium.....	409
4.2.4.1	Emissions to air	410
4.2.4.1.1	Collection and prevention of emissions	410
4.2.4.1.2	Dust and metals	411
4.2.4.1.3	Organic compounds (TOC, PCDD/F) and CO	411
4.2.4.1.4	Sulphur dioxide and oxides of nitrogen.....	412
4.2.4.1.5	HF, HCl and chlorine	413
4.2.4.2	Emissions to water	413
4.2.4.3	Process residues	414
4.2.4.4	Energy consumption.....	416
4.2.4.5	Mass stream overview and input/output data	417
4.2.5	Salt slag	420
4.2.5.1	Dust and other emissions to air	421
4.2.5.2	Water and solid waste	421
4.2.5.3	Energy use.....	422
4.3	TECHNIQUES TO CONSIDER IN THE DETERMINATION OF BAT	423
4.3.1	Alumina.....	423
4.3.1.1	Techniques to reduce dust emissions from the storage, handling, and transport of bauxite and alumina	423
4.3.1.2	Techniques to reduce emissions from drying furnaces, boilers and calcination furnaces for alumina production.....	424
4.3.1.3	Techniques to prevent and minimise bauxite residue from alumina production ..	426
4.3.1.4	Techniques to reduce energy consumption for the production of alumina from bauxite	427
4.3.2	Anodes for aluminium production	429
4.3.2.1	Techniques to reduce emissions from the storage, handling and transport of primary and secondary raw materials.....	429
4.3.2.2	Techniques to reduce dust and PAH emissions from the grinding, mixing and forming stages	431
4.3.2.3	Techniques to reduce emissions from baking in anode production	435
4.3.3	Primary aluminium.....	443
4.3.3.1	Techniques to reduce emissions from the storage, handling and transport of the raw materials used for primary aluminium production	443
4.3.3.2	Techniques to reduce the emissions of perfluorocarbons from primary aluminium production	444
4.3.3.3	Techniques to prevent or collect diffuse emissions from both the cells and the pot room in primary aluminium production using Söderberg technology.....	445
4.3.3.4	Techniques to prevent or collect diffuse emissions from electrolytic cells in primary aluminium production using prebaked anodes	446
4.3.3.5	Techniques to reduce dust and fluorides from cell gases	448
4.3.3.6	Techniques to reduce dust and fluorides from cell gases and anode production process gases	456
4.3.3.7	Techniques to prevent SO ₂ emissions from cell gases	456
4.3.3.8	Techniques to reduce SO ₂ from cell gases from electrolysis and pot room ventilation.....	459
4.3.3.9	Techniques to reduce emissions from melting and molten metal treatment and casting in primary aluminium smelters	462

4.3.3.10	Techniques to reuse the spent pot lining (SPL)	463
4.3.4	Secondary aluminium	464
4.3.4.1	Techniques to reduce emissions from the storage, handling and transport of the raw materials used for secondary aluminium production	464
4.3.4.2	Techniques to separate non-metallic components and metals other than aluminium and to reduce their size before the melting stage	465
4.3.4.3	Techniques to remove oil and organic compounds from swarf before the melting stage	466
4.3.4.4	Selection of the appropriate secondary melting furnaces	470
4.3.4.5	Techniques to reduce diffuse emissions to air from melting furnaces in secondary aluminium production	474
4.3.4.6	Technique to reduce dust emissions to air from the melting process	476
4.3.4.7	Techniques to reduce the emissions to air of organic carbon from the melting furnace	479
4.3.4.8	Techniques to reduce the emissions to air of acid gases and organic carbon, including PCDD/F	481
4.3.4.9	Techniques to prevent and reduce emissions to air from molten metal treatment in secondary aluminium production	484
4.3.4.10	Techniques to prevent and reduce emissions from remelting	486
4.3.4.11	Techniques to prevent and reduce emissions to air from skimmings/dross	488
4.3.4.12	Techniques to prevent or reduce the production of salt slag	489
4.3.4.12.1	Use of metal pumping or a stirring system to improve efficiency and reduce salt usage	489
4.3.4.12.2	Technique to improve efficiency and minimise the use of salt cover	491
4.3.5	Salt slag	492
4.3.5.1	Full recycling of salt slag	492
4.3.5.2	Partial recycling of salt slag	494
4.3.5.3	Techniques to reduce emissions to air from salt slag treatment	495
4.3.5.3.1	Dust filters for crushing and dry milling of salt slag	495
4.3.5.3.2	Activated carbon filter	497
4.3.5.3.3	Wet acid scrubber	498
4.3.5.3.4	Afterburner	499
4.3.6	Waste water	500
4.4	EMERGING TECHNIQUES	501
5	PROCESSES TO PRODUCE LEAD AND TIN	503
5.1	APPLIED PROCESSES AND TECHNIQUES	503
5.1.1	Primary lead	503
5.1.1.1	Sintering/smelting using a blast furnace or Imperial Smelting Furnace	504
5.1.1.2	Direct smelting	504
5.1.2	Primary tin	505
5.1.3	Secondary lead and tin production	505
5.1.3.1	Recovery of lead from lead-acid batteries	506
5.1.3.2	Recovery of lead from residues and scrap	508
5.1.3.3	Recovery of lead and tin from residues and from flue-dusts from copper smelting	509
5.1.3.4	Recovery of tin from steel scrap	510
5.1.3.5	Recovery of lead, tin and other metals from secondary raw materials and wastes	510
5.1.4	Refining of primary and secondary lead and tin	510
5.1.5	Melting and alloying processes for lead	513
5.2	CURRENT EMISSION AND CONSUMPTION LEVELS	514
5.2.1	Energy	516
5.2.2	Emissions to air	516
5.2.2.1	Sulphur dioxide and other sulphur compounds	518
5.2.2.2	Nitrogen oxides	519
5.2.2.3	Dust and metals	519

5.2.2.4	Organic compounds (VOCs, PCDD/F) and CO.....	521
5.2.3	Emissions to water	521
5.2.3.1	Waste waters from abatement plants.....	521
5.2.3.2	Waste waters from battery recovery.....	522
5.2.4	Process residues.....	524
5.2.4.1	Pyrometallurgical slags and residues	525
5.2.4.2	Plastics from battery processing.....	528
5.3	TECHNIQUES TO CONSIDER IN THE DETERMINATION OF BAT.....	529
5.3.1	Raw material reception, handling and storage	529
5.3.2	Material pretreatment	529
5.3.2.1	Techniques to prevent and reduce emissions from primary and secondary material preparation (excluding batteries).....	529
5.3.2.2	Techniques to prevent and reduce emissions to air from primary and secondary material drying	532
5.3.2.3	Techniques to prevent and reduce emissions from dismantling, sintering, briquetting and pelletising.....	536
5.3.2.4	Techniques to prevent and reduce emissions from battery preparation.....	537
5.3.2.5	Technique to reduce sulphur gas emissions from the smelting process	541
5.3.3	Lead production using primary and secondary materials (primary smelters) .	544
5.3.3.1	Techniques to prevent and reduce emissions to air from primary smelter process gases	544
5.3.3.2	Techniques to prevent and reduce diffuse emissions in primary lead production from charging, tapping, and pre-decoppering	549
5.3.3.3	Techniques to prevent and reduce diffuse emissions to air in primary lead production from slag treatment	551
5.3.4	Lead and tin production using secondary materials (secondary smelters)	553
5.3.4.1	Techniques to prevent and reduce diffuse emissions to air in secondary lead and tin production	553
5.3.4.2	Techniques to reduce channelled emissions of dusty air from the secondary smelter off-gas.....	557
5.3.4.3	Techniques to reduce SO ₂ emissions from the furnaces of secondary smelters ...	564
5.3.4.4	Use of afterburners to remove carbon monoxide and organic carbon including PCDD/F.....	569
5.3.4.5	Use of a regenerative thermal oxidiser (RTO) to remove organic carbon, including PCDD/F.....	572
5.3.4.6	Techniques to prevent and reduce PCDD/F emissions to air	574
5.3.5	Remelting and refining, alloying and casting in lead and tin production.....	578
5.3.5.1	Techniques to prevent and reduce emissions from remelting, refining, and casting in primary and secondary lead and tin production	578
5.3.6	Waste water	584
5.3.6.1	Techniques to prevent waste water	584
5.3.6.2	Inorganic waste water treatment process.....	585
5.3.7	Process residues.....	591
5.3.7.1	Techniques to prevent and minimise residues and wastes from primary smelters.....	591
5.3.7.2	External or internal use of acid and plastics from battery treatment	593
5.3.7.3	Techniques to prevent and minimise residues and waste from secondary smelters	596
5.3.8	Energy	597
5.3.8.1	Heat recovery from the process gases in primary lead production and in secondary lead and tin production.....	597
5.4	EMERGING TECHNIQUES	599
6	PROCESSES TO PRODUCE ZINC AND CADMIUM	601
6.1	APPLIED PROCESSES AND TECHNIQUES	601
6.1.1	Primary zinc	601
6.1.1.1	Environmental issues	601

6.1.1.2	The pyrometallurgical route.....	601
6.1.1.3	The hydrometallurgical route.....	605
6.1.1.3.1	Roasting	607
6.1.1.3.2	Calcine processing	608
6.1.1.3.3	Leaching	609
6.1.1.3.4	Purification	611
6.1.1.3.4.1	Purification using chemicals	612
6.1.1.3.4.2	Purification using solvent extraction.....	614
6.1.1.3.5	Electrolysis	615
6.1.1.3.6	Neutral leach residue treatment and disposal of iron residues	616
6.1.1.3.6.1	Pyrometallurgical treatment of neutral leach residue.....	616
6.1.1.3.6.2	Hydrometallurgical treatment of neutral leach residue	616
6.1.2	Secondary zinc	620
6.1.2.1	General processes	620
6.1.2.2	Solvent extraction processes for secondary zinc.....	622
6.1.2.3	Waelz kilns	622
6.1.2.4	Slag fuming processes	624
6.1.2.4.1	The plasma arc fuming process.....	624
6.1.2.4.2	The fuming furnace process for the production of secondary ZnO from the copper smelter.....	625
6.1.2.5	Remelting and refining	625
6.1.3	Melting, alloying and casting processes for zinc	625
6.1.3.1	Melting and alloying processes for zinc	625
6.1.3.2	Casting processes for zinc	626
6.1.3.3	Production of zinc powder ('zinc dust').....	626
6.1.4	Cadmium.....	627
6.1.4.1	Production of cadmium from primary zinc processes	627
6.1.4.2	Production of secondary cadmium, mainly from batteries	632
6.1.4.3	Production of other metals (In, Ge, Ga).....	633
6.2	CURRENT EMISSION AND CONSUMPTION LEVELS	634
6.2.1	Energy	636
6.2.2	Emissions to air.....	637
6.2.2.1	Sulphur dioxide and other sulphur compounds.....	639
6.2.2.2	Nitrogen oxides.....	639
6.2.2.3	Dust and metals	640
6.2.2.4	PCDD/F	641
6.2.3	Emissions to water.....	642
6.2.3.1	Waste waters from abatement plants	642
6.2.3.2	Electrolyte bleed effluent.....	643
6.2.3.3	Waste waters from miscellaneous sources.....	643
6.2.4	Process residues	644
6.2.4.1	Leaching residues	647
6.2.4.2	Pyrometallurgical slags and residues	648
6.3	TECHNIQUES TO CONSIDER IN THE DETERMINATION OF BAT	650
6.3.1	Zinc production using primary and secondary materials	650
6.3.1.1	Techniques to reduce emissions from raw material reception, handling and storage.....	650
6.3.1.2	Hydrometallurgical zinc production	651
6.3.1.2.1	Techniques to prevent and reduce emissions from the roasting of primary materials.....	651
6.3.1.2.2	Techniques to prevent and reduce emissions from calcine processing	655
6.3.1.2.3	Techniques to prevent and reduce emissions from leaching and solid-liquid separation.....	658
6.3.1.2.4	Techniques to prevent and reduce emissions from solution purification using zinc powder and chemical additives.....	662
6.3.1.2.5	Techniques to prevent and reduce emissions from electrolysis	666

6.3.1.2.5.1	Techniques to prevent and reduce emissions from electrolysis coolers	666
6.3.1.2.5.2	Techniques to prevent and reduce mists from electrowinning inside the cell house	668
6.3.1.2.5.3	Techniques to prevent and reduce waste water from the cell house	670
6.3.1.2.6	Techniques to prevent waste water from hydrometallurgical zinc production	671
6.3.1.2.7	Techniques to prevent and minimise residues and wastes from hydrometallurgical zinc production.....	673
6.3.1.2.8	Techniques to improve the disposal of leaching residues from hydrometallurgical zinc production.....	676
6.3.1.2.8.1	Pyrometallurgical treatment to improve the disposal of leaching residues from hydrometallurgical zinc production	676
6.3.1.2.8.2	Inertisation and compaction techniques to improve the disposal of leaching residues from hydrometallurgical zinc production.....	679
6.3.1.2.8.2.1	Jarofix process.....	679
6.3.1.2.8.2.2	Sulphidation process	682
6.3.1.2.8.2.3	Compacting iron residues	684
6.3.1.2.9	Techniques to recover heat from hydrometallurgical zinc production	686
6.3.1.3	Pyrometallurgical zinc production	687
6.3.1.3.1	Techniques to reduce emissions to air in pyrometallurgical zinc production.....	687
6.3.1.3.2	Techniques to reduce SO ₂ and dioxins emissions in pyrometallurgical zinc production	691
6.3.2	Primary and secondary zinc production applying recycling routes.....	692
6.3.2.1	Recycling of metallic streams	692
6.3.2.1.1	Techniques to reduce emissions from melting metallic and mixed metallic/oxidic streams.....	692
6.3.2.2	Recycling of oxidic raw materials.....	693
6.3.2.2.1	Techniques to prevent and reduce emissions from fuming furnaces	693
6.3.2.2.1.1	Techniques to prevent and reduce emissions from the plasma arc fuming process	693
6.3.2.2.1.2	Techniques to prevent and reduce emissions from a fuming furnace in a process for production of secondary ZnO from a copper smelter	695
6.3.2.2.2	Techniques to prevent and reduce emissions from multiple hearth furnaces.....	697
6.3.2.2.3	Techniques to prevent and reduce emissions from the rotary Waelz kiln process.....	697
6.3.2.2.3.1	Techniques to prevent and reduce emissions from secondary materials during pelletising	697
6.3.2.2.3.2	Techniques to prevent and reduce emissions from melting in rotary Waelz kilns.....	698
6.3.2.2.3.3	Techniques to prevent and reduce emissions from slag processing.....	700
6.3.2.2.3.4	Techniques to prevent and reduce waste water in the Waelz kiln process.....	701
6.3.2.2.3.5	Waste water treatment in the Waelz kiln process	703
6.3.2.2.3.6	Techniques to prevent and minimise residues and wastes from the Waelz kiln process.....	706
6.3.3	Melting, alloying and casting of zinc ingots (primary, secondary, hydrometallurgical and pyrometallurgical processes).....	706
6.3.3.1	Techniques to prevent and reduce emissions from melting, remelting, alloying, holding and casting furnaces and zinc dust production.....	706
6.3.3.2	Techniques to prevent and minimise residues and wastes from the melting processes	709
6.3.3.3	Techniques to prevent waste water	711
6.3.4	Treatment of waste water from zinc production plants (primary, secondary, hydrometallurgical and pyrometallurgical processes).....	712
6.3.4.1	Treatment of waste water from hydrometallurgical and pyrometallurgical zinc production	712
6.3.5	Cadmium production and recycling routes	719

6.3.5.1	Hydrometallurgical cadmium production	719
6.3.5.1.1	Techniques to prevent and reduce emissions from leaching and solid-liquid separation.....	719
6.3.5.1.2	Techniques to prevent emissions from electrolysis.....	719
6.3.5.1.3	Techniques to prevent and minimise residues and wastes from hydrometallurgical cadmium production	720
6.3.5.2	Pyrometallurgical cadmium production.....	722
6.3.5.2.1	Techniques to prevent and reduce emissions from the cadmium plant in pyrometallurgical zinc production (ISP).....	722
6.3.5.2.2	Techniques to prevent and reduce emissions from briquetting and pelletising metallic cadmium cements	722
6.3.5.2.3	Techniques to reduce emissions from cadmium recovery by fuming/condensation.....	723
6.3.5.2.4	Techniques to prevent and minimise residues and wastes from pyrometallurgical cadmium production	724
6.3.5.3	Melting, alloying and casting of cadmium ingots (primary and secondary loops)	724
6.3.5.3.1	Techniques to prevent and reduce emissions from melting, remelting, alloying, and holding and casting furnaces	724
6.3.5.3.2	Techniques to prevent and minimise residues and wastes from the melting process	726
6.3.5.3.3	Techniques to prevent waste water	726
6.3.5.4	Treatment of waste water from cadmium production plants (primary, secondary, hydrometallurgical and pyrometallurgical processes)	727
6.4	EMERGING TECHNIQUES.....	728
7	PROCESSES TO PRODUCE PRECIOUS METALS.....	729
7.1	APPLIED PROCESSES AND TECHNIQUES.....	729
7.1.1	Silver.....	732
7.1.1.1	Photographic materials	732
7.1.1.2	Ashes, sweeps, etc.	732
7.1.1.3	Recovery from base metal production	733
7.1.1.4	Refining	735
7.1.2	Gold	735
7.1.2.1	The Miller process	735
7.1.2.2	Electrorefining	736
7.1.2.3	Other processes for gold recovery	736
7.1.3	Platinum group metals (PGMs)	736
7.2	CURRENT EMISSION AND CONSUMPTION LEVELS	738
7.2.1	Material loops in the precious metal recycling industry	738
7.2.1.1	The non-metallic cycles.....	738
7.2.1.2	The non-PM loops	739
7.2.2	Environmental issues for precious metal production processes.....	740
7.2.2.1	Emissions to air	740
7.2.2.1.1	Dust and metals.....	741
7.2.2.1.2	Sulphur dioxide.....	741
7.2.2.1.3	Chlorine and HCl.....	741
7.2.2.1.4	Nitrogen oxides.....	742
7.2.2.1.5	VOCs and PCDD/F.....	742
7.2.2.1.6	Summary of emissions to air.....	742
7.2.2.2	Emissions to water.....	744
7.2.2.3	Process residues.....	745
7.3	TECHNIQUES TO CONSIDER IN THE DETERMINATION OF BAT	746
7.3.1	Techniques to prevent and reduce dust emissions from PM material pretreatment and handling operations (e.g. crushing, sieving and mixing)	746
7.3.2	Techniques to prevent and reduce emissions from PM smelting and melting operations (excluding those related to the production of Doré metal).....	749

7.3.3	Techniques to prevent and reduce emissions from pyrometallurgical processes for the production of Doré metal.....	752
7.3.4	Techniques to prevent and reduce emissions from (electrolytic) silver and gold refining	759
7.3.5	Techniques to prevent and reduce emissions from PM hydrometallurgical operations	762
7.3.6	Techniques to prevent and reduce emissions from PM incineration, calcining and drying operations	769
7.3.7	Techniques to prevent, treat and release or recover waste liquors from PM refining operations.....	774
7.3.8	Techniques to prevent and reduce emissions from the melting of final metal products in PM refining.....	779
7.4	EMERGING TECHNIQUES	781
8	PROCESSES TO PRODUCE FERRO-ALLOYS	783
8.1	APPLIED PROCESSES AND TECHNIQUES	784
8.1.1	Ferro-chrome	784
8.1.1.1	Raw materials.....	784
8.1.1.2	Pretreatment techniques	785
8.1.1.3	Production of ferro-chrome and silico-chromium	786
8.1.1.3.1	High-carbon ferro-chrome.....	786
8.1.1.3.2	Medium-carbon ferro-chrome	789
8.1.1.3.3	Low-carbon ferro-chrome	789
8.1.1.3.4	Silico-chromium.....	790
8.1.2	Ferro-silicon and silicon alloys	790
8.1.2.1	Raw materials.....	790
8.1.2.2	Production of ferro-silicon, silicon metal and silico-calcium.....	791
8.1.3	Ferro-manganese and manganese alloys	793
8.1.3.1	Raw materials.....	793
8.1.3.2	Pretreatment techniques	794
8.1.3.3	Production of ferro-manganese and silico-manganese	794
8.1.3.3.1	High-carbon ferro-manganese	794
8.1.3.3.2	Medium-carbon ferro-manganese	795
8.1.3.3.3	Low-carbon ferro-manganese.....	796
8.1.3.3.4	Silico-manganese	796
8.1.4	Ferro-nickel	797
8.1.4.1	Raw materials.....	797
8.1.4.2	Production of ferro-nickel from primary raw materials	797
8.1.4.3	Production of ferro-nickel from secondary raw materials	798
8.1.5	Ferro-vanadium	798
8.1.5.1	Raw materials.....	798
8.1.5.2	Production of ferro-vanadium	799
8.1.5.3	Post-production operations.....	801
8.1.6	Molybdenite roasting and the production of ferro-molybdenum	801
8.1.6.1	Molybdenite roasting	801
8.1.6.2	Production of ferro-molybdenum.....	803
8.1.6.2.1	Raw materials	804
8.1.6.2.2	Metallothermic production of ferro-molybdenum.....	804
8.1.7	Ferro-tungsten	807
8.1.7.1	Production of ferro-tungsten and tungsten melting base	807
8.1.8	Ferro-titanium	807
8.1.9	Ferro-boron	810
8.1.10	Ferro-niobium	811
8.1.11	Production of ferro-alloys from secondary raw materials.....	811

8.1.11.1	Raw material and its preparation	811
8.1.11.2	Preprocessing	813
8.1.11.2.1	Mixing and drying (plasma dust process only)	813
8.1.11.3	Submerged arc furnace process	813
8.1.11.4	Plasma dust process	814
8.1.12	Summary of the smelting systems used in the ferro-alloy industry	815
8.2	CURRENT EMISSION AND CONSUMPTION LEVELS	818
8.2.1	Consumption of raw material and energy	818
8.2.2	Emissions to air	823
8.2.2.1	Dust and fume emissions	823
8.2.2.2	Other emissions to air	829
8.2.3	Emissions of noise and vibrations	833
8.2.4	Emissions to water	834
8.2.5	Process residues	835
8.2.6	Energy recovery	839
8.3	TECHNIQUES TO CONSIDER IN THE DETERMINATION OF BAT	842
8.3.1	Raw materials, reception, handling and storage	842
8.3.1.1	Techniques to reduce emissions from the reception, storage and handling of primary materials	842
8.3.2	Material pretreatment techniques	843
8.3.2.1	Techniques to reduce emissions from the crushing and grinding of raw materials	843
8.3.2.2	Techniques to reduce emissions from metering, mixing and blending	845
8.3.2.3	Techniques to prevent and reduce emissions from the briquetting, pelletising, sintering of raw materials	846
8.3.2.4	Techniques to reduce emissions from the drying of ores and other raw materials	848
8.3.2.5	Techniques to reduce emissions from coke drying	848
8.3.2.6	Techniques to reduce emissions from the thermal treatment of rolling scale or swarf before smelting	849
8.3.2.7	Preheating and pre-reduction of ores to reduce the energy consumption	850
8.3.3	Ferro-alloy reduction	852
8.3.3.1	Techniques to prevent and reduce emissions from smelters	852
8.3.3.1.1	Techniques to prevent and reduce emissions from open submerged arc furnaces	852
8.3.3.1.2	Techniques to prevent and reduce emissions from semi-closed submerged arc furnaces	857
8.3.3.1.3	Techniques to prevent and reduce emissions from closed submerged arc furnaces	860
8.3.3.1.4	Techniques to prevent and reduce emissions from the closed plasma dust process	864
8.3.3.1.5	Techniques to prevent and reduce emissions from multiple hearth furnaces	865
8.3.3.1.6	Techniques to prevent and reduce emissions from refractory-lined crucibles	867
8.3.3.1.7	Techniques to prevent and reduce emissions from rotary kiln furnaces	869
8.3.3.2	Techniques to reduce emissions in ferro-alloy production from tapping	870
8.3.4	Casting, refining and alloying in ferro-alloy production	873
8.3.4.1	Techniques to reduce emissions in ferro-alloy production from casting, transfer and refilling operations	873
8.3.4.2	Techniques to reduce diffuse emissions in ferro-alloy production from refining and alloying	874
8.3.5	Ferro-alloy post-furnace operations	875
8.3.5.1	Techniques to reduce emissions from size reduction of products	875
8.3.5.2	Techniques to reduce diffuse emissions from the handling, storage and transport of very fine products	877
8.3.5.3	Techniques to reduce emissions in ferro-alloy production from packaging	878
8.3.5.4	Techniques to reduce emissions in ferro-alloy production from slag treatment	879

8.3.6	Waste water	880
8.3.6.1	Techniques to prevent waste water	880
8.3.6.2	Waste water treatment	881
8.3.7	Process residues	888
8.3.7.1	Techniques to prevent and minimise residues and wastes from ferro-alloy production	888
8.3.8	Energy	889
8.3.8.1	Technique to recover heat from semi-closed furnaces	889
8.3.8.2	Energy recovery from closed electric arc furnaces	892
8.3.8.3	Energy recovery from other furnaces	893
8.4	EMERGING TECHNIQUES	895
9	PROCESSES TO PRODUCE NICKEL AND COBALT	897
9.1	APPLIED PROCESSES AND TECHNIQUES	897
9.1.1	Nickel production	897
9.1.1.1	Oxidic ores	897
9.1.1.2	Sulphidic ores	899
9.1.1.2.1	Conventional flash smelting process	900
9.1.1.2.2	Direct Outotec Nickel (DON) process	901
9.1.1.3	Matte refining processes	902
9.1.1.3.1	Chloride leaching of matte followed by electrowinning	903
9.1.1.3.2	Sulphate-based atmospheric pressure leaching followed by electrowinning/hydrogen reduction	904
9.1.1.3.3	Ammonia pressure leach and hydrogen reduction	907
9.1.1.3.4	Ferric chloride leaching	907
9.1.1.3.5	Carbonyl process	907
9.1.1.3.6	Matte electrorefining	908
9.1.1.3.7	Solvent extraction	908
9.1.1.3.8	Nickel matte refining process	908
9.1.1.4	Nickel alloy production from secondary materials	910
9.1.2	Cobalt production	911
9.2	CURRENT EMISSION AND CONSUMPTION LEVELS	913
9.2.1	Energy consumption	913
9.2.2	Emissions to air	913
9.2.2.1	Sulphur dioxide and other acid gases	914
9.2.2.2	VOCs	914
9.2.2.3	Dust and metals	915
9.2.2.4	Chlorine	916
9.2.2.5	Hydrogen, carbon monoxide and carbonyls	916
9.2.2.6	Nitrogen oxides	916
9.2.2.7	Diffuse emissions	916
9.2.3	Emissions to water	917
9.2.3.1	Waste waters from abatement plants	918
9.2.3.2	Miscellaneous sources	918
9.2.4	Process residues	920
9.2.4.1	Precipitates from purification processes	920
9.2.4.2	Pyrometallurgical slags and residues	921
9.2.4.3	Other materials	921
9.3	TECHNIQUES TO CONSIDER IN THE DETERMINATION OF BAT	922
9.3.1	Nickel production	922
9.3.1.1	Material reception, storage and handling processes	922
9.3.1.1.1	Techniques to prevent and reduce emissions from the reception, storage and handling of materials	922
9.3.1.2	Material pretreatment processes	923

9.3.1.2.1	Techniques to prevent and reduce emissions from ore preparation and beneficiation	923
9.3.1.2.2	Techniques to prevent and reduce emissions from nickel ore and concentrates drying	925
9.3.1.3	Pyrometallurgical transformation processes	926
9.3.1.3.1	Techniques to reduce emissions from the charging of furnaces in primary nickel production	926
9.3.1.3.2	Techniques to prevent and reduce emissions from the DON process	927
9.3.1.3.3	Techniques to prevent and reduce emissions from the EAF	930
9.3.1.3.4	Techniques to prevent and reduce emissions from a nickel converting process	932
9.3.1.4	Hydrometallurgical nickel refining processes	933
9.3.1.4.1	Techniques to reduce emissions from atmospheric and pressure leaching ..	933
9.3.1.4.2	Techniques to reduce emissions from solvent extraction refining (sulphate route).....	934
9.3.1.4.3	Techniques to reduce emissions from the nickel matte refining process using ferric chloride leaching with chlorine (chlorine route).....	936
9.3.1.4.4	Techniques to reduce emissions from electrowinning	937
9.3.1.4.5	Techniques to reduce emissions to air from the carbonyl process	938
9.3.1.4.6	Techniques to reduce emissions from hydrogen reduction processes when producing nickel powder and nickel briquettes (pressure processes)	941
9.3.1.5	Waste water	942
9.3.1.5.1	Techniques to prevent the generation of waste water	942
9.3.1.5.2	Waste water treatment	942
9.3.1.6	Process residues	949
9.3.1.6.1	Techniques to prevent and minimise residues and wastes	949
9.3.1.7	Energy efficiency and reduction	950
9.3.2	Cobalt production	953
9.3.2.1	Techniques to reduce emissions from a cobalt solvent extraction process	953
9.3.2.2	Techniques to reduce emissions from mixed hydroxide and mixed sulphide precipitation	954
9.3.2.3	Techniques to reduce emissions from electrowinning	956
9.4	EMERGING TECHNIQUES.....	957
9.4.1	Thermal decomposition of nickel complexes	957
10	PROCESSES TO PRODUCE CARBON AND GRAPHITE ELECTRODES, CATHODES AND SHAPES.....	959
10.1	APPLIED PROCESSES AND TECHNIQUES.....	959
10.1.1	Processes to produce calcined materials	960
10.1.2	Processes to produce paste, green powders and green shapes	961
10.1.3	Processes to produce baked shapes.....	962
10.1.4	Processes to produce impregnated shapes	965
10.1.5	Processes to produce rebaked shapes from impregnated shapes	965
10.1.6	Processes to produce graphitised shapes.....	965
10.1.7	Processes to produce machine baked, rebaked or graphitised products	967
10.1.8	Processes to produce speciality carbon and graphite products	967
10.2	CURRENT EMISSION AND CONSUMPTION LEVELS	968
10.2.1	Emissions to air.....	968
10.2.1.1	Polycyclic aromatic hydrocarbons	969
10.2.1.2	Dust.....	970
10.2.1.3	Combustion gases	971
10.2.1.4	Sulphur dioxide.....	971
10.2.1.5	VOCs (from the manufacture of special carbon and graphite products).....	971
10.2.1.6	Cyanides (polyacrylonitrile (PAN)-based carbon fibre production).....	971
10.2.1.7	PCDD/F	971
10.2.1.8	Summary of the main air pollutants.....	971

10.2.2	Emissions to water	975
10.2.3	Process residues.....	975
10.3	TECHNIQUES TO CONSIDER IN THE DETERMINATION OF BAT	977
10.3.1	Raw material reception, handling and storage	977
10.3.1.1	Techniques to reduce emissions from the storage, handling, and transport of solid materials	977
10.3.1.2	Techniques to reduce emissions from the storage, handling and transport of liquid pitch	978
10.3.2	Material pretreatment operations.....	979
10.3.2.1	Techniques to reduce emissions from calcining of coal and coke.....	979
10.3.2.2	Techniques to reduce emissions from mechanical preparation of raw material such as grinding and sieving	979
10.3.3	Carbon and graphite production.....	979
10.3.3.1	Techniques to reduce dust and PAH emissions from mixing and shaping (production of green paste and green shapes)	979
10.3.3.2	Techniques to reduce emissions from baking and rebaking.....	983
10.3.3.3	Techniques to reduce emissions from impregnation	988
10.3.3.4	Techniques to reduce emissions from graphitising	991
10.3.3.5	Techniques to reduce emissions from machining	991
10.3.3.6	Techniques to reduce emissions from special carbon manufacturing processes ..	992
10.3.4	Waste water.....	992
10.3.4.1	Techniques to prevent and control emissions of waste water.....	992
10.3.4.2	Techniques to reduce emissions of waste water.....	992
10.3.5	Process residues.....	992
10.4	EMERGING TECHNIQUES	993
11	BEST AVAILABLE TECHNIQUES (BAT) CONCLUSIONS.....	995
	SCOPE	995
	DEFINITIONS	997
	GENERAL CONSIDERATIONS	998
	ACRONYMS.....	998
11.1	GENERAL BAT CONCLUSIONS.....	999
11.1.1	Environmental management systems (EMS)	999
11.1.2	Energy management.....	1000
11.1.3	Process control	1001
11.1.4	Diffuse emissions	1002
11.1.4.1	General approach for the prevention of diffuse emissions	1002
11.1.4.2	Diffuse emissions from the storage, handling and transport of raw materials....	1002
11.1.4.3	Diffuse emissions from metal production	1004
11.1.5	Monitoring of emissions to air	1005
11.1.6	Mercury emissions	1008
11.1.7	Sulphur dioxide emissions	1009
11.1.8	NO _x emissions	1009
11.1.9	Emissions to water, including their monitoring	1010
11.1.10	Noise	1013
11.1.11	Odour.....	1013
11.2	BAT CONCLUSIONS FOR COPPER PRODUCTION	1014
11.2.1	Secondary materials	1014
11.2.2	Energy	1014
11.2.3	Air emissions.....	1015
11.2.3.1	Diffuse emissions.....	1015
11.2.3.2	Channelled dust emissions	1019

11.2.3.3	Organic compound emissions	1021
11.2.3.4	Sulphur dioxide emissions	1022
11.2.3.5	Acid emissions	1023
11.2.4	Soil and groundwater	1023
11.2.5	Waste water generation	1023
11.2.6	Waste	1024
11.3	BAT CONCLUSIONS FOR ALUMINIUM PRODUCTION INCLUDING ALUMINA AND ANODE PRODUCTION	1025
11.3.1	Alumina production	1025
11.3.1.1	Energy	1025
11.3.1.2	Air emissions	1026
11.3.1.3	Waste	1026
11.3.2	Anode production	1026
11.3.2.1	Air emissions	1026
11.3.2.1.1	Dust, PAH and fluoride emissions from the paste plant	1026
11.3.2.1.2	Dust, sulphur dioxide, PAH and fluoride emissions from the baking plant	1027
11.3.2.2	Waste water generation	1028
11.3.2.3	Waste	1028
11.3.3	Primary aluminium production	1028
11.3.3.1	Air emissions	1028
11.3.3.1.1	Channelled dust and fluoride emissions	1029
11.3.3.1.2	Total emissions of dust and fluorides	1030
11.3.3.1.3	Sulphur dioxide emissions	1031
11.3.3.1.4	Perfluorocarbon emissions	1032
11.3.3.1.5	PAH and CO emissions	1032
11.3.3.2	Waste water generation	1032
11.3.3.3	Waste	1032
11.3.4	Secondary aluminium production	1033
11.3.4.1	Secondary materials	1033
11.3.4.2	Energy	1033
11.3.4.3	Air emissions	1033
11.3.4.3.1	Diffuse emissions	1033
11.3.4.3.2	Channelled dust emissions	1034
11.3.4.3.3	Organic compound emissions	1035
11.3.4.3.4	Acid emissions	1036
11.3.4.4	Waste	1037
11.3.5	Salt slag recycling process	1037
11.3.5.1	Diffuse emissions	1037
11.3.5.2	Channelled dust emissions	1037
11.3.5.3	Gaseous compounds	1038
11.4	BAT CONCLUSIONS FOR LEAD AND/OR TIN PRODUCTION	1039
11.4.1	Air emissions	1039
11.4.1.1	Diffuse emissions	1039
11.4.1.2	Channelled dust emissions	1041
11.4.1.3	Organic compound emissions	1042
11.4.1.4	Sulphur dioxide emissions	1043
11.4.2	Soil and groundwater protection	1044
11.4.3	Waste water generation and treatment	1044
11.4.4	Waste	1044
11.5	BAT CONCLUSIONS FOR ZINC AND/OR CADMIUM PRODUCTION	1046
11.5.1	Primary zinc production	1046
11.5.1.1	Hydrometallurgical zinc production	1046
11.5.1.1.1	Energy	1046
11.5.1.1.2	Air emissions	1046

11.5.1.1.2.1	Diffuse emissions	1046
11.5.1.1.2.2	Channelled emissions	1047
11.5.1.1.3	Soil and groundwater protection	1047
11.5.1.1.4	Waste water generation	1048
11.5.1.1.5	Waste.....	1048
11.5.1.2	Pyrometallurgical zinc production	1049
11.5.1.2.1	Air emissions.....	1049
11.5.1.2.1.1	Channelled dust emissions	1049
11.5.2	Secondary zinc production	1049
11.5.2.1	Air emissions.....	1049
11.5.2.1.1	Channelled dust emissions	1049
11.5.2.1.2	Organic compound emissions	1050
11.5.2.1.3	Acid emissions	1051
11.5.2.2	Waste water generation and treatment	1051
11.5.3	Melting, alloying and casting of zinc ingots and zinc powder production.....	1052
11.5.3.1	Air emissions.....	1052
11.5.3.1.1	Diffuse dust emissions.....	1052
11.5.3.1.2	Channelled dust emissions	1052
11.5.3.2	Waste water.....	1052
11.5.3.3	Waste.....	1052
11.5.4	Cadmium production.....	1053
11.5.4.1	Air emissions.....	1053
11.5.4.1.1	Diffuse emissions	1053
11.5.4.1.2	Channelled dust emissions	1053
11.5.4.2	Waste.....	1054
11.6	BAT CONCLUSIONS FOR PRECIOUS METALS PRODUCTION	1055
11.6.1	Air emissions.....	1055
11.6.1.1	Diffuse emissions	1055
11.6.1.2	Channelled dust emissions	1056
11.6.1.3	NO _x emissions	1057
11.6.1.4	Sulphur dioxide emissions	1057
11.6.1.5	HCl and Cl ₂ emissions.....	1058
11.6.1.6	NH ₃ emissions	1058
11.6.1.7	PCDD/F emissions	1059
11.6.2	Soil and groundwater protection	1059
11.6.3	Waste water generation	1059
11.6.4	Waste.....	1059
11.7	BAT CONCLUSIONS FOR FERRO-ALLOYS PRODUCTION	1061
11.7.1	Energy	1061
11.7.2	Air emissions.....	1061
11.7.2.1	Diffuse dust emissions	1061
11.7.2.2	Channelled dust emissions	1062
11.7.2.3	PCDD/F emissions	1063
11.7.2.4	PAH and organic compound emissions.....	1063
11.7.3	Waste.....	1064
11.8	BAT CONCLUSIONS FOR NICKEL AND/OR COBALT PRODUCTION	1065
11.8.1	Energy	1065
11.8.2	Air emissions.....	1065
11.8.2.1	Diffuse emissions	1065
11.8.2.2	Channelled dust emissions	1066
11.8.2.3	Nickel and chlorine emissions.....	1066
11.8.2.4	Sulphur dioxide emissions	1067
11.8.2.5	NH ₃ emissions.....	1067
11.8.3	Waste.....	1068

11.9	BAT CONCLUSIONS FOR CARBON AND/OR GRAPHITE PRODUCTION	1069
11.9.1	Air emissions	1069
11.9.1.1	Diffuse emissions	1069
11.9.1.2	Dust and PAH emissions	1069
11.9.1.3	Sulphur dioxide emissions	1071
11.9.1.4	Organic compound emissions	1071
11.9.2	Waste	1071
11.10	DESCRIPTION OF TECHNIQUES.....	1072
11.10.1	Air emissions	1072
11.10.1.1	Dust emissions	1072
11.10.1.2	NO _x emissions.....	1072
11.10.1.3	SO ₂ , HCl, and HF emissions.....	1073
11.10.1.4	Mercury emissions.....	1073
11.10.1.5	VOC, PAH and PCDD/F emissions.....	1074
11.10.2	Water emissions.....	1075
11.10.3	Other descriptions	1075
12	CONCLUDING REMARKS AND RECOMMENDATIONS FOR FUTURE WORK	1077
13	ANNEXES	1083
13.1	METAL PRODUCTION PROCESSES	1083
13.1.1	Furnaces for roasting and calcining	1085
13.1.1.1	Rotary kilns.....	1085
13.1.1.2	Fluidised bed reactors	1085
13.1.1.3	Multiple hearth or Herreshoff furnace	1086
13.1.1.4	Sintering furnaces	1087
13.1.2	Smelting furnaces	1088
13.1.2.1	Reverberatory, hearth or closed well furnaces	1088
13.1.2.2	Blast furnaces (and the Imperial Smelting Furnace).....	1089
13.1.2.3	Electric reduction furnaces	1091
13.1.2.4	Electric (resistance) furnaces	1094
13.1.2.5	Rotary furnace	1095
13.1.2.6	Refractory-lined pits and crucibles	1095
13.1.2.7	Ausmelt/ISASMELT furnaces and the KRS furnace.....	1096
13.1.2.8	Top-blown rotary converter (TBRC) and tilting rotary oxy-fuel furnace (TROF).....	1097
13.1.2.9	The Noranda, El Teniente, Baiyin and Vanyukov processes.....	1098
13.1.2.10	The Mitsubishi process	1100
13.1.2.11	The QSL furnace.....	1100
13.1.2.12	Cyclone smelting furnaces.....	1101
13.1.2.13	The Outotec flash furnace	1102
13.1.2.14	The INCO furnace	1103
13.1.2.15	The Kivcet (KSS) furnace.....	1104
13.1.3	Converters.....	1104
13.1.3.1	The Peirce-Smith converter	1104
13.1.3.2	The Hoboken converter	1106
13.1.3.3	The Kennecott-Outotec flash converter	1107
13.1.3.4	Other converters	1107
13.1.4	Melting and refining furnaces.....	1108
13.1.4.1	Induction furnaces	1108
13.1.4.2	Indirectly heated kettles	1108
13.1.4.3	Shaft furnaces for melting metal.....	1109
13.1.4.4	The Continmelt process	1109
13.1.4.5	Electron beam furnaces.....	1110
13.1.4.6	Rotary furnace	1110
13.1.4.7	Reverberatory (closed well) furnaces	1111

13.1.5	Summary of furnaces in common use	1112
13.1.6	Electrochemical processes.....	1114
13.1.6.1	Electrowinning	1114
13.1.6.2	Electrorefining.....	1114
13.1.6.3	Molten salt electrolysis	1115
13.1.7	Hydrometallurgical processes	1115
13.1.7.1	Heap leaching.....	1115
13.1.7.2	Atmospheric leaching (open tank)	1116
13.1.7.3	Pressure leaching (autoclaving)	1116
13.1.7.4	Solvent extraction.....	1116
13.2	ENVIRONMENTAL MONITORING PRACTICES	1118
13.2.1	Examples of environmental monitoring practices	1118
13.2.1.1	Examples from the Nordic countries.....	1118
13.2.1.2	Examples from other countries.....	1120
13.2.1.3	Studies in Austria	1121
13.2.1.4	Studies in Belgium	1121
13.2.2	Ecotoxicity and bioavailability.....	1122
13.3	SPECIFIC COST DATA FOR METAL PRODUCTION AND ABATEMENT.....	1125
13.3.1	Influences on cost data	1125
13.3.2	Specific investment costs for copper process plants	1127
13.3.3	Specific investment costs for primary and secondary aluminium processes..	1130
13.3.4	Specific investment costs for lead-zinc processes.....	1131
13.3.5	Cost data for abatement techniques.....	1133
13.3.5.1	Air emissions abatement in the copper industry.....	1133
13.3.5.2	Air emissions abatement - aluminium industry.....	1142
13.3.5.2.1	Costs associated with deSO _x	1147
13.3.5.3	Sulphuric acid plants	1149
13.3.5.4	Effluent treatment systems	1150
14	GLOSSARY.....	1151
I.	ISO COUNTRY CODES.....	1151
II.	MONETARY UNITS	1152
III.	UNIT PREFIXES, NUMBER SEPARATORS AND NOTATIONS.....	1152
IV.	UNITS AND MEASURES	1153
V.	CHEMICAL ELEMENTS.....	1154
VI.	CHEMICAL FORMULAE COMMONLY USED IN THIS DOCUMENT	1155
VII.	ACRONYMS AND DEFINITIONS	1156
	REFERENCES.....	1169

List of Figures

Figure 1.1:	Worldwide copper production in 2005.....	6
Figure 1.2:	Copper semis products produced in 2003	7
Figure 1.3:	End uses for semis produced in the EU in 2003.....	8
Figure 1.4:	European lead refining capacity in 2007	17
Figure 1.5:	World production of zinc from concentrates in 2007 excluding China.....	23
Figure 1.6:	European uses of nickel in 2005.....	38
Figure 1.7:	European nickel production in 2006	40
Figure 2.1:	Energy balance of the Contimelt process	54
Figure 2.2:	House-in-house collection system.....	67
Figure 2.3:	Typical gas-cleaning train for a sulphuric acid plant	77
Figure 2.4:	Typical double absorption sulphuric acid plant.....	78
Figure 2.5:	Comparison of the effect of steady- and non-steady-state SO ₂ inlet concentrations on conversion efficiency	79
Figure 2.6:	Equation for the calculation of the outlet concentration and the conversion rate.....	79
Figure 2.7:	Conversion of SO ₂ to sulphuric acid	80
Figure 2.8:	Effluent classification.....	85
Figure 2.9:	Granulation of molten metal	87
Figure 2.10:	Closed water loop in granulation systems	88
Figure 2.11:	Different recycling routes according to the amount of residues generated by some non-ferrous metals plants in North Rhine-Westphalia.....	93
Figure 2.12:	Electric furnace cleaning of copper slags.....	94
Figure 2.13:	Continuous improvement in an EMS model	103
Figure 2.14:	First half of the regenerative burner cycle.....	108
Figure 2.15:	Second half of the regenerative burner cycle	108
Figure 2.16:	Regenerative afterburner	109
Figure 2.17:	Electricity generation from low-grade heat	111
Figure 2.18:	Fourth hole fume collection	123
Figure 2.19:	Coinciding charging and tapping system	124
Figure 2.20:	Outline of a secondary fume collection system for a primary copper process	125
Figure 2.21:	Secondary hooding system for a converter	126
Figure 2.22:	Taphole fume collection.....	126
Figure 2.23:	Typical arrangement of an electrostatic precipitator (only two zones shown)	129
Figure 2.24:	Wet electrostatic precipitator.....	131
Figure 2.25:	Arrangement of a cyclone	132
Figure 2.26:	Reverse airflow bag filter (with one compartment in the cleaning cycle).....	134
Figure 2.27:	Reverse pulse jet cleaning system	135
Figure 2.28:	Low-pressure air pulsing cleaning system	136
Figure 2.29:	Radial flow wet scrubber.....	140
Figure 2.30:	The process to produce liquid sulphur dioxide.....	161
Figure 2.31:	Mercury emissions to air from different non-ferrous metals production processes	167
Figure 2.32:	Example of a cooling water recirculation system.....	170
Figure 2.33:	Treatment of weak acid	177
Figure 2.34:	Schematic of a sand filter	181
Figure 2.35:	Arrangement of a simple biofilter	189
Figure 2.36:	The BAYQIK process	192
Figure 3.1:	Primary copper production.....	200
Figure 3.2:	Flowsheet of a hydrometallurgical process	205
Figure 3.3:	Generic flowsheet for secondary copper production.....	208
Figure 3.4:	Example of the Southwire process	210
Figure 3.5:	Example of the Contirod process	211
Figure 3.6:	General flowsheet for semi-finished product fabrication	212
Figure 3.7:	Principle of continuous or semi-continuous casting.....	214
Figure 3.8:	Generic input and output diagram for primary copper smelting	221
Figure 3.9:	Treatment of smelter and converter gases	222
Figure 3.10:	Generic input and output diagram for secondary copper smelting.....	223
Figure 3.11:	Example of an input and output diagram from a secondary copper production site with a tin/lead recovery process	224
Figure 3.12:	Metallo-Chimique – Material storage and drying	256
Figure 3.13:	Flowsheet of a fluidised bed roaster furnace and gas treatment system	265
Figure 3.14:	Local hood for matte tapping at the Toyo smelter.....	270
Figure 3.15:	Secondary hooding system for a converter	277

Figure 3.16:	Continuous pickling process	345
Figure 4.1:	General principle of the Bayer process	377
Figure 4.2:	The Bayer process	379
Figure 4.3:	Production of green anodes	380
Figure 4.4:	Anode baking furnace configurations and approximated number of plants	382
Figure 4.5:	Primary aluminium electrolytic cells	384
Figure 4.6:	Generic secondary aluminium production process	388
Figure 4.7:	Anode baking process and fume treatment	394
Figure 4.8:	Input and output from primary aluminium production	397
Figure 4.9:	Input and output from secondary aluminium production	409
Figure 4.10:	Skimmings/dross recovery processes	415
Figure 4.11:	Mass flow of a salt slag full recycling process	420
Figure 4.12:	An illustration of an integral fume collection system	475
Figure 4.13:	Dust emissions from the melting process in secondary aluminium production plants	477
Figure 4.14:	TVOC emissions in secondary aluminium production plants	480
Figure 4.15:	HCl emissions in secondary aluminium production plants	482
Figure 4.16:	Cl ₂ emissions in secondary aluminium production plants	483
Figure 4.17:	HF emissions in secondary aluminium production plants	483
Figure 4.18:	PCDD/F emissions in secondary aluminium production plants	484
Figure 4.19:	An example of a metal-pumping system	490
Figure 4.20:	An example of the full salt slag recycling process	493
Figure 5.1:	Outline of a typical shaft furnace lead-acid battery recovery process	506
Figure 5.2:	Outline of a typical lead-acid battery recovery process	507
Figure 5.3:	Example diagram of lead refining processes	512
Figure 5.4:	Flow diagram of desulphurisation of battery paste by alkaline leaching	542
Figure 5.5:	Afterburner system used with a whole battery smelter (VARTA process)	570
Figure 5.6:	General plant layout with a RTO	573
Figure 5.7:	Flow chart showing PCDD/F abatement techniques at Metallo-Chimique Beerse	575
Figure 5.8:	Comparison between lead and tin vapour pressures	579
Figure 6.1:	Diagram of a typical Imperial Smelting Process	602
Figure 6.2:	Diagram of zinc-cadmium distillation	605
Figure 6.3:	Simplified diagram of the hydrometallurgical route	606
Figure 6.4:	Roasting gas cleaning stage 1: dry gas cleaning (cyclone optional)	607
Figure 6.5:	Roasting gas cleaning stage 2: wet gas cleaning	608
Figure 6.6:	Simplified flowsheet of the leaching process	609
Figure 6.7:	Flowsheet of the leaching process with an integrated atmospheric direct leach to increase the plant capacity	611
Figure 6.8:	Example flowsheet for an As-based purification process for removal of Co and Ni	612
Figure 6.9:	Flowsheet of the Sb-based purification process at Plant D	613
Figure 6.10:	Simplified flowsheet of the Modified Zincex TM Process SX	614
Figure 6.11:	Example flowsheet for leach residue treatment in the goethite process	617
Figure 6.12:	Example flowsheet for leach residue treatment in the jarosite process	618
Figure 6.13:	Simplified flowsheets of some iron removal processes	619
Figure 6.14:	Flowsheet of the Waelz process	623
Figure 6.15:	Cadmium production flowsheet: Plant A	628
Figure 6.16:	Cadmium production flowsheet: Plant B	629
Figure 6.17:	Purification flowsheet including cadmium production: Plant C	630
Figure 6.18:	Cadmium production flowsheet: Plant D	630
Figure 6.19:	Cadmium production flowsheet: Plant E	631
Figure 6.20:	Cadmium production flowsheet: Plant F	632
Figure 6.21:	Collection and abatement of emissions from the roaster feed preparation and the roaster	652
Figure 6.22:	Collection and abatement of emissions from calcine processing	656
Figure 6.23:	Single tank abatement system	660
Figure 6.24:	Central abatement system with centrifugal-type mist collector	664
Figure 6.25:	Landscape restoration with Jarofix	680
Figure 6.26:	Flowsheet of the sulphidation process	682
Figure 6.27:	Flowsheet of the plasma arc fuming process	694
Figure 6.28:	Fuming furnace integrated with a clinker furnace in a copper smelter process	696
Figure 6.29:	Diagram of a Waelz oxide three-stage countercurrent washing circuit	702
Figure 6.30:	Diagram of a Waelz oxide two-stage countercurrent washing circuit	702
Figure 6.31:	Flowsheet of a generic treatment for waste/residues produced during zinc melting	710
Figure 7.1:	Example of a general flowsheet for precious metal recovery	730
Figure 7.2:	Example flowsheet for anode slime treatment	731

Figure 7.3:	Recovery of silver from zinc and lead production	734
Figure 7.4:	Metallurgical process flowsheet	782
Figure 8.1:	Steel belt sintering process	786
Figure 8.2:	Slag granulation process.....	787
Figure 8.3:	High-carbon ferro-chrome production using a closed submerged electric arc furnace	788
Figure 8.4:	Ferro-chrome production using a semi-closed submerged arc furnace	789
Figure 8.5:	Energy balance for a silicon production process with energy recovery	792
Figure 8.6:	Energy balance for a silicon production process without energy recovery	793
Figure 8.7:	Closed electric arc ferro-manganese furnace operating with Søderberg electrodes	795
Figure 8.8:	Ferro-vanadium production flowsheet	800
Figure 8.9:	Molybdenite roasting flowsheet	801
Figure 8.10:	Molybdenite roasting and gas cleaning (the Netherlands)	802
Figure 8.11:	Molybdenite roasting and waste water treatment (the Netherlands)	803
Figure 8.12:	Ferro-molybdenum production flowsheet	804
Figure 8.13:	Metallothermic firing arrangement	805
Figure 8.14:	Production of ferro-molybdenum by metallothermic reduction	806
Figure 8.15:	Gas-cleaning system for a degreasing plant	808
Figure 8.16:	Flow diagram for ferro-titanium production	809
Figure 8.17:	Process for ferro-boron and boron alloy production	810
Figure 8.18:	Plasma dust processing smelter (Sweden).....	815
Figure 8.19:	Ferro-alloy production flow diagram showing potential points of emissions to air	824
Figure 8.20:	Energy flowsheet (in MW _{th}) in a 10 MW _e silicon furnace	839
Figure 8.21:	Hooding system used in some silicon and ferro-silicon furnaces.....	871
Figure 8.22:	Energy recovery from a semi-closed furnace	890
Figure 8.23:	Direct use of the CO gas for the production of electrical energy	892
Figure 9.1:	Generic flowsheet for nickel production from laterite ores	898
Figure 9.2:	Generic flowsheet for the production of nickel from sulphidic concentrates	900
Figure 9.3:	Conventional flash smelting process	901
Figure 9.4:	The DON process	902
Figure 9.5:	Generic flowsheet for nickel matte refining processes	903
Figure 9.6:	The Falconbridge process.....	904
Figure 9.7:	Sulphate-based leaching process	905
Figure 9.8:	Flowsheet of the DON refining process	906
Figure 9.9:	The Sherritt ammonia leach process	907
Figure 9.10:	Solvent extraction (SX) process outline	908
Figure 9.11:	Flowsheet of the Eramet refining process	910
Figure 9.12:	Generic flowsheet for cobalt production	912
Figure 9.13:	A practical cobalt flowsheet	912
Figure 10.1:	Overview of carbon and graphite production	960
Figure 10.2:	General view of a multi-chamber furnace (open ring furnace)	963
Figure 10.3:	General view of a single chamber furnace (car bottom furnace).....	964
Figure 10.4:	Castner graphitising furnace.....	966
Figure 10.5:	Acheson graphitising furnace	966
Figure 10.6:	Generic emission diagram of the carbon and graphite production processes	968
Figure 10.7:	Dry adsorption scrubber with dust injection and dust removal	980
Figure 10.8:	Biofilter and bioscrubber.....	989
Figure 13.1:	Rotary kiln.....	1085
Figure 13.2:	Fluidised bed reactors.....	1086
Figure 13.3:	The Herreshoff or multiple hearth furnace	1087
Figure 13.4:	Steel belt sintering furnace	1088
Figure 13.5:	An example of a tilting reverberatory hearth furnace used for secondary materials	1089
Figure 13.6:	Blast furnace for primary copper smelting	1090
Figure 13.7:	Blast furnace for secondary copper production	1091
Figure 13.8:	Electric reduction furnace process and auxiliary equipment	1092
Figure 13.9:	Søderberg electrode system in an electric arc furnace	1093
Figure 13.10:	Rotary electric reduction furnace	1094
Figure 13.11:	Electric furnace for concentrate or calcine smelting	1095
Figure 13.12:	The Ausmelt (Sirosmelt)/ISASMELT furnace.....	1096
Figure 13.13:	TBRC and TROF	1098
Figure 13.14:	The Noranda reactor	1099
Figure 13.15:	The El Teniente reactor	1099
Figure 13.16:	The Mitsubishi process.....	1100
Figure 13.17:	The QSL furnace	1101

Figure 13.18: The Contop process	1101
Figure 13.19: The Outotec flash furnace.....	1102
Figure 13.20: The INCO furnace	1103
Figure 13.21: The Kivcet furnace	1104
Figure 13.22: The Peirce-Smith converter	1105
Figure 13.23: The Hoboken converter	1106
Figure 13.24: Induction furnaces	1108
Figure 13.25: The Contimelt Process.....	1110
Figure 13.26: Solvent extraction (SX) processing stages.....	1116
Figure 13.27: Process diagram of the modified Zincex process.....	1117
Figure 13.28: Trend of zinc concentrations in seawater over time near a zinc smelter.....	1119
Figure 13.29: Trends of the concentration of As and Cd in the air measured at Elbe island in Hamburg (DE)	1120
Figure 13.30: The trend in lead concentrations in PM ₁₀ from 2002 to 2011 for some sampling stations in Flanders	1122

List of Tables

Table 1.1:	Maximum tolerable impurities	4
Table 1.2:	European production of copper and its alloys in 2011	7
Table 1.3:	Production of aluminium in the EU-27 in 2007 and 2012.....	11
Table 1.4:	Primary aluminium production and consumption by country in 2007 and 2012	12
Table 1.5:	Imports of primary aluminium to the EU-27 in 2007 and 2012	12
Table 1.6:	Chemical composition of the grades of lead according to the European Standard.....	14
Table 1.7:	Uses of lead worldwide	14
Table 1.8:	Annual capacities for lead processes in the EU-27 in 2006	16
Table 1.9:	Annual world production of tin (mined) in 2006 and 2012	19
Table 1.10:	Annual world production of tin (smelter) in 2006 and 2012	20
Table 1.11:	World and European uses of zinc	21
Table 1.12:	Primary zinc grades.....	21
Table 1.13:	Secondary zinc grades.....	22
Table 1.14:	World production of zinc concentrates in 2007.....	23
Table 1.15:	World production of refined zinc	24
Table 1.16:	Production of zinc in Europe from primary raw materials in 2007	24
Table 1.17:	Recycling units for zinc from end-of-life products in the EU (2007)	24
Table 1.18:	Main cadmium producers and users in 2007	26
Table 1.19:	Main European primary and secondary cadmium producers in 2007	28
Table 1.20:	Precious metal mine production in 2005 and 2012	29
Table 1.21:	Annual capacities of European refineries in 2006.....	30
Table 1.22:	Precious metal demand in 2006.....	31
Table 1.23:	European production of bulk ferro-alloys from 2006 to 2012 in tonnes per year	34
Table 1.24:	Global ferro-alloy production by furnace type and alloy type from 2003 to 2007 in tonnes per year (gross weight).....	35
Table 1.25:	Nickel production sites in Europe in 2006	39
Table 1.26:	European production of nickel from 2006 to 2012 in tonnes per year	39
Table 1.27:	Breakdown of the total cobalt production to the different sectors of use	42
Table 1.28:	Worldwide cobalt production	43
Table 1.29:	Production of some major carbon and graphite products in Europe in 2012 (tonnes).....	45
Table 2.1:	Processes that may form integrated installations.....	48
Table 2.2:	Comparison of abated and diffuse dust loads at a primary copper smelter	58
Table 2.3:	Double contact/double absorption sulphuric acid plants associated with non-ferrous metals production	81
Table 2.4:	Upgraded sulphuric acid plants with lower SO ₂ inlet concentration variations associated with non-ferrous metals production	83
Table 2.5:	Single contact sulphuric acid plants associated with non-ferrous metals production.....	84
Table 2.6:	Potential sources of liquid effluents from the hydrometallurgical production of non-ferrous metals	89
Table 2.7:	Amount of recycled, reused and discharged residues reported in 1996 for some non-ferrous metals plants in North Rhine-Westphalia.....	95
Table 2.8:	Amount of recycled, reused and discharged residues reported in 1996 for some non-ferrous metals plants in North Rhine-Westphalia.....	96
Table 2.9:	Residues and potential uses.....	98
Table 2.10:	Information for each technique	102
Table 2.11:	Techno-economic comparison of an oxy-fuel burner compared to an air-fuel burner	107
Table 2.12:	Comparison between different fabric filter systems	138
Table 2.13:	Overview of dust abatement techniques.....	142
Table 2.14:	Emissions of nitrogen oxide from several processes.....	149
Table 2.15:	Data on costs involved in oxy-fuel firing for secondary aluminium production	150
Table 2.16:	Sulphuric acid plants operating under varying gas conditions	156
Table 2.17:	Performance data for a sulphuric acid plant operating under variable conditions	157
Table 2.18:	Costs for changes to existing sulphuric acid plants	158
Table 2.19:	Upgraded sulphuric acid plants with lower SO ₂ inlet concentration variations associated with non-ferrous metal production	159
Table 2.20:	The yearly average emissions of sulphur dioxide from Boliden	161
Table 2.21:	Performance of the Hg removal techniques applied at Boliden Rönnskär	166
Table 2.22:	Overview of waste water streams and the treatment and minimisation techniques.....	169
Table 2.23:	Examples of recycling and reuse.....	169
Table 2.24:	Summary of advantages and disadvantages of common waste water treatment techniques.....	172

Table 2.25:	Performance data for the treatment of weak acid	178
Table 2.26:	Typical passage of ions across a reverse osmosis membrane	184
Table 2.27:	The capital cost comparison between the LUREC [®] add-on module and a conventional plant	193
Table 3.1:	Primary copper smelting technologies	197
Table 3.2:	Worldwide use of the smelting technologies for primary copper production	199
Table 3.3:	Example of impurity removal levels during electrorefining	203
Table 3.4:	Secondary raw materials for copper production	206
Table 3.5:	Comparison of the plant data for typical vertical and horizontal continuous casting installations	215
Table 3.6:	Typical data for a process to produce brass strip	217
Table 3.7:	Comparison of abated and diffuse dust loads at a primary copper smelter	220
Table 3.8:	Example input and output data for a primary copper smelter/refinery	222
Table 3.9:	Input and output data for the secondary copper process shown in Figure 3.11	225
Table 3.10:	Differences in the operating parameters between a KRS furnace and a shaft furnace	225
Table 3.11:	Significance of potential emissions to air from copper production process	226
Table 3.12:	Main constituents of dust from copper processes	228
Table 3.13:	Concentrations of dust constituents and PCDD/F in the clean gas of all unit processes from a secondary copper smelter	229
Table 3.14:	Specific emissions to air from some primary and secondary processes	232
Table 3.15:	Achievable emissions from some secondary smelting and remelting/refining processes (with semis fabrication)	233
Table 3.16:	Emissions and operating data from converters in secondary copper production	234
Table 3.17:	Significance of potential emissions to water from copper production processes	234
Table 3.18:	Annual concentrations of the main constituents in the untreated waste water from a primary copper smelter	235
Table 3.19:	Example of the metal content in various waste waters after treatment	236
Table 3.20:	Overall pollutant rate of waste water discharges from two complex primary copper plants	236
Table 3.21:	Annual loads discharged to water from a copper semis production plant	236
Table 3.22:	Residues from the production of copper	237
Table 3.23:	Residues from primary and secondary smelting processes in Germany	238
Table 3.24:	Residues from some remelting/refining processes (with semis fabrication)	239
Table 3.25:	Potential uses and examples of the quantity of residues produced by a complex primary and secondary installation	240
Table 3.26:	Potential uses and examples of the quantity of residues produced by a secondary installation	241
Table 3.27:	Composition of some copper smelting slags before slag cleaning treatment	241
Table 3.28:	Operating data for a copper electrorefining unit	242
Table 3.29:	Operating data for an electric furnace	242
Table 3.30:	Operating data for a KRS furnace	243
Table 3.31:	Operating data for an anode reverberatory furnace	243
Table 3.32:	Operating data for a rotary drum furnace	244
Table 3.33:	Operating data for a shaft furnace of a continuous casting installation	244
Table 3.34:	Operating data for a shaft furnace of a cast-and-rolled wire installation	245
Table 3.35:	Operating data for crucible induction furnaces for the production of copper alloys	245
Table 3.36:	Operating data for channel induction furnaces for the production of copper alloys	246
Table 3.37:	Operating data for a secondary copper process (remelting)	247
Table 3.38:	Operational data for Metallo-Chimique dryers	256
Table 3.39:	Emissions from four turnings dryers in 2010	259
Table 3.40:	Operational and performance data for concentrate drying (part 1)	261
Table 3.41:	Operational and performance data for concentrate drying (part 2)	262
Table 3.42:	Operational and performance data for primary smelting furnaces (part 1)	273
Table 3.43:	Operational and performance data for primary smelting furnaces (part 2)	274
Table 3.44:	Operational and performance data for primary converters	280
Table 3.45:	Operational and performance data for slag cleaning furnaces	290
Table 3.46:	TVOC emissions of Aurubis Olen in 2013	293
Table 3.47:	Operational and performance data for melting and fire refining primary smelters	295
Table 3.48:	Operational and performance data for melting and fire refining primary smelters	296
Table 3.49:	Operational and performance data for melting and fire refining secondary smelters	297
Table 3.50:	Relevant parameters for the centralised gas collection and abatement system at Aurubis Hamburg	300

Table 3.51:	Relevant parameters for the centralised gas collection and abatement system at Aurubis Pirdop.....	301
Table 3.52:	Emissions from the centralised gas collection and abatement system in Boliden Harjavalta.....	302
Table 3.53:	Typical characterisation of secondary raffinate at Cobre Las Cruces.....	315
Table 3.54:	Operational and performance data for secondary smelting (part 1).....	321
Table 3.55:	Operational and performance data for secondary smelting (part 2).....	323
Table 3.56:	Emissions and operational data for NO _x emission in copper production.....	330
Table 3.57:	Operational and performance data for secondary converters.....	335
Table 3.58:	Techniques to reduce emissions from acid and acid pickling of copper rods and semis of copper and copper alloys.....	347
Table 3.59:	Operational and performance data for lead and tin recovery from secondary copper intermediates.....	349
Table 3.60:	Operational and performance data for a rotary lead alloy furnace.....	350
Table 3.61:	Performance of a waste water treatment plant.....	354
Table 3.62:	Composition of process waters before and after treatment at Aurubis Pirdop.....	355
Table 3.63:	Composition of process waters before and after treatment at Aurubis Hamburg.....	356
Table 3.64:	Composition of the surface run-off water from the east plant area and blowdown of direct cooling water at the anode casting facility before and after treatment at Aurubis Hamburg.....	356
Table 3.65:	Composition of the surface run-off water from the area covering the secondary copper smelter, shapes installations and the lead refinery before and after treatment at Aurubis Hamburg.....	357
Table 3.66:	Composition of waste water after treatment at Aurubis Olen.....	358
Table 3.67:	Composition of waste water after treatment at Montanwerke Brixlegg.....	359
Table 3.68:	Composition of waste water before and after treatment at Umicore Hoboken.....	360
Table 3.69:	Composition of waste water after treatment at Metallo-Chimique Beerse.....	361
Table 3.70:	Composition of waste water after treatment at Legnica, Głogów 1 and 2.....	362
Table 3.71:	Composition of waste water before and after treatment at Atlantic Copper.....	363
Table 3.72:	Composition of waste water before and after treatment at Boliden Harjavalta.....	364
Table 3.73:	Composition of waste water after treatment at Boliden Rönnskär.....	364
Table 3.74:	Composition of waste water after treatment at Cobre Las Cruces.....	365
Table 3.75:	Intermediates, residues and wastes from the production of copper.....	367
Table 3.76:	Emerging bath smelting techniques.....	375
Table 4.1:	Comparison of baking processes.....	380
Table 4.2:	Aluminium smelting categories.....	386
Table 4.3:	Typical composition of the salt slag.....	390
Table 4.4:	Typical contents of the insoluble non-metallic portion of salt slag.....	391
Table 4.5:	Input ranges for alumina production.....	392
Table 4.6:	Raw gas from anode production in a plant associated with a primary aluminium smelter.....	394
Table 4.7:	Emission concentration ranges for anode production processes.....	395
Table 4.8:	Emission specific load ranges from the production of prebaked anodes.....	395
Table 4.9:	Input ranges for electrolysis.....	398
Table 4.10:	Casthouse consumption data.....	398
Table 4.11:	Primary aluminium casthouse emissions to air.....	403
Table 4.12:	Significance of potential emissions from primary aluminium production.....	405
Table 4.13:	Total emissions (roof + stack) to air from primary aluminium smelters with direct emissions of roof vents to the atmosphere and without wet scrubbing.....	405
Table 4.14:	Total emissions (roof + stack) to air from primary aluminium smelters with BSS for pot gas (prebake plants) or roof vent wet scrubbing (modified Söderberg).....	405
Table 4.15:	SO ₂ emissions to air from primary aluminium smelters with wet scrubbing applied to pot gas.....	405
Table 4.16:	Process emissions to water from the primary aluminium electrolysis plants using ventilation air wet scrubbers or SO ₂ wet scrubbers.....	406
Table 4.17:	Composition of spent pot lining.....	407
Table 4.18:	Options to reduce waste in a primary aluminium smelter.....	408
Table 4.19:	Specific waste quantities from primary aluminium production.....	408
Table 4.20:	Significance of potential emissions to air.....	410
Table 4.21:	Dust emissions from secondary aluminium production.....	411
Table 4.22:	PCDD/F and TVOC emissions from secondary aluminium production.....	412
Table 4.23:	NO _x (measured as NO ₂) emissions from secondary aluminium production.....	413
Table 4.24:	HCl, Cl ₂ and HF emissions from secondary aluminium production.....	413
Table 4.25:	Typical residues from secondary aluminium production.....	414

Table 4.26:	Emissions from skimmings/dross treatment	416
Table 4.27:	Typical composition of filter dust from secondary aluminium production.....	416
Table 4.28:	Range of the typical plant, process and emission parameters (raw gas) of secondary aluminium production plants	418
Table 4.29:	Typical outputs from salt slag recovery.....	420
Table 4.30:	Collected air and dust emissions from salt slag recycling plants.....	421
Table 4.31:	Emissions from alumina calcining plants	425
Table 4.32:	Dust emissions range from the handling, storage and transport of raw materials.....	430
Table 4.33:	Emissions from coke dust removal.....	432
Table 4.34:	Emissions from pitch scrubbing processes	433
Table 4.35:	Emissions from anode baking after abatement with an alumina scrubber and bag filter in Plant E	436
Table 4.36:	Emissions from anode baking after abatement with an alumina scrubber and bag filter in a plant in Germany.....	437
Table 4.37:	Emissions from anode baking after abatement with an alumina scrubber and bag filter in a plant in France	438
Table 4.38:	Emissions from anode baking after abatement with a wet scrubber combined with dry injection cleaning in a combined anode and aluminium production plant.....	439
Table 4.39:	Emissions from anode baking after abatement with a wet scrubber combined with an ESP and dry scrubber in a combined anode and aluminium production plant.....	439
Table 4.40:	Emissions from anode baking after abatement with RTO in combination with a wet scrubber with seawater and ESP.....	440
Table 4.41:	Emissions from anode baking after abatement with a RTO in a stand-alone anode production plant (part 1)	441
Table 4.42:	Emissions from anode baking after abatement with a RTO in a stand-alone anode production plant (part 2)	441
Table 4.43:	Off-gas collected for treatment and ventilation airflow in several European primary aluminium plants	447
Table 4.44:	Dust, HF and total fluoride stack emissions (mass loads) from PFPB plants using alumina scrubbers and bag filters	449
Table 4.45:	Dust stack emissions (concentrations) from a PFPB plant during 2013	450
Table 4.46:	Dust stack emissions (concentrations) from a PFPB plant during 2012	450
Table 4.47:	Dust stack emissions (concentrations) from a PFPB plant during 2011	450
Table 4.48:	Dust stack emissions (mass loads) from Plant UK 1 during 2012	451
Table 4.49:	Dust stack emissions (concentrations) from German PFPB plants using alumina scrubbers and bag filters	451
Table 4.50:	HF stack emissions (concentrations) from German PFPB plants using alumina scrubbers and bag filters	451
Table 4.51:	Dust, HF and total fluoride stack emissions (mass loads) from PFPB plants using alumina scrubbers, bag filters and wet scrubbers	452
Table 4.52:	Dust, HF and total fluoride stack emissions (mass loads) from Söderberg plants using alumina scrubbers and bag filters	453
Table 4.53:	Dust, HF and total fluoride stack emissions (mass loads) from the Söderberg plant using an alumina scrubber, bag filter and wet scrubber	453
Table 4.54:	Total dust and fluorides emissions (stack and roof) from primary aluminium plants using an alumina scrubber and bag filter in the stack	454
Table 4.55:	Total dust and fluorides emissions (stack and roof) from primary aluminium plants using a wet scrubber in addition to the alumina scrubber and bag filter.....	455
Table 4.56:	Dust and HF roof emissions from German PFPB plants using alumina scrubbers and bag filters	455
Table 4.57:	SO ₂ stack emissions from PFPB plants using low-sulphur anodes (but not using a wet scrubber).....	457
Table 4.58:	SO ₂ stack emissions from Söderberg plants using low-sulphur anodes (but not using a wet scrubber)	458
Table 4.59:	SO ₂ total emissions (stack and roof) from primary aluminium plants using low-sulphur anodes (but not using a wet scrubber).....	458
Table 4.60:	SO ₂ emissions from PFPB plants using a wet scrubber in addition to an alumina scrubber and a bag filter	460
Table 4.61:	SO ₂ emissions (stack and roof) from a Söderberg plant using a wet scrubber in addition to an alumina scrubber and a bag filter.....	460
Table 4.62:	SO ₂ total emissions (stack and roof) from primary aluminium plants using a wet scrubber in addition to alumina scrubbers and bag filters.....	461

Table 4.63:	Dust emissions from the transport and loading of materials for secondary aluminium production	464
Table 4.64:	Dust emissions from the milling stage in secondary aluminium production	466
Table 4.65:	Emissions from swarf dryers	467
Table 4.66:	Advantages and disadvantages of secondary melting furnaces	472
Table 4.67:	Emissions from the melting process of an Austrian plant	478
Table 4.68:	TVOC emissions, measured continuously, in a secondary aluminium plant	479
Table 4.69:	HCl, Cl ₂ and HF emissions from molten metal treatment in secondary aluminium production	485
Table 4.70:	Dust emissions from Site 1	487
Table 4.71:	Dust emissions from Site 2	487
Table 4.72:	Dust emissions from Site 3 and Site 4	488
Table 4.73:	Dust emissions from the crushing and dry milling of salt slag	496
Table 4.74:	Emissions from the wet mill after the activated carbon filter	498
Table 4.75:	Emissions from the crushing, leaching, filtering and washing of salt slag	500
Table 5.1:	Composition ranges for the main constituents of lead concentrate	503
Table 5.2:	Summary of direct smelting processes	505
Table 5.3:	Raw materials used in different direct smelting processes	505
Table 5.4:	Composition of typical lead-acid battery scrap	506
Table 5.5:	Input and output data for an Ausmelt/ISASMELT furnace	514
Table 5.6:	Input and output data for a QSL plant	514
Table 5.7:	Input and output data for a battery recovery plant with desulphurisation (preparation and short rotary furnace)	515
Table 5.8:	Input and output data for a battery recovery plant with whole battery smelting (shaft furnace)	515
Table 5.9:	Energy requirement of various lead processes	516
Table 5.10:	Significance of potential emissions to air from lead production	517
Table 5.11:	Significance of the diffuse emissions	518
Table 5.12:	Sulphur dioxide production from several lead processes	519
Table 5.13:	Mass release of metals from some European processes	520
Table 5.14:	Typical gas-cleaning effluents before treatment	522
Table 5.15:	Typical waste water analyses	523
Table 5.16:	Potential waste water sources and treatment techniques	524
Table 5.17:	Solid material from the refining of lead bullion	525
Table 5.18:	Residues from lead processes	526
Table 5.19:	Residues from direct lead smelting processes	527
Table 5.20:	Dust emissions from material preparation	531
Table 5.21:	Emissions from material drying in Metallo-Chimique Beerse	534
Table 5.22:	Emissions from material drying in Aurubis Hamburg	534
Table 5.23:	Emissions from the drying process in primary and secondary lead and tin production	535
Table 5.24:	Emissions to air from battery preparation	539
Table 5.25:	Emissions to water from battery preparation in Plant 5	540
Table 5.26:	Emissions from rotary furnaces fed with desulphurised raw materials	543
Table 5.27:	Emissions from the furnace in Plant 8	546
Table 5.28:	SO ₂ emissions from the wet sulphuric acid plant at KCM's new lead plant in Plovdiv	547
Table 5.29:	Secondary emissions from an electric furnace in Plant 18	550
Table 5.30:	Secondary emissions from furnaces in Plant 17	550
Table 5.31:	Dust emissions from the diffuse emissions abatement plant at Metallo-Chimique	553
Table 5.32:	Dust and SO ₂ emissions after the house-in-house system and a bag filter with lime injection	554
Table 5.33:	Secondary emissions from an electric furnace with a bag filter	555
Table 5.34:	Dust and metals emissions from Plants 6, 15 and 19	555
Table 5.35:	Example of dust emissions from secondary smelters	558
Table 5.36:	Example of dust emissions from the ISASMELT smelter and blast furnace for secondary lead and tin production at Umicore Hoboken	558
Table 5.37:	Dust and metals emissions from secondary lead production furnaces	560
Table 5.38:	Performance data for example plants	566
Table 5.39:	SO ₂ emissions from secondary lead and tin plants in the EU-28	567
Table 5.40:	Performance data for a shaft furnace with an afterburner	571
Table 5.41:	Emissions from afterburners in secondary lead and tin production	571
Table 5.42:	Total C and BaP emissions at the main stack	573
Table 5.43:	PCDD/F emissions from lead and tin furnaces	576
Table 5.44:	Emissions from the refining process in Metallo-Chimique Beerse	580

Table 5.45:	Data emissions from refining and casting.....	581
Table 5.46:	Emissions to water from lead and tin production plants.....	587
Table 6.1:	Main reagent and utilities consumption in the Modified Zincex™ Process.....	615
Table 6.2:	Typical data for a German RLE plant with integration of secondary raw material.....	634
Table 6.3:	Typical composition of feed and products for a zinc RLE plant with integration of secondary raw material.....	635
Table 6.4:	Input and output data for a Waelz plant using the SDHL process.....	635
Table 6.5:	Input and output data for a Waelz oxide washing process.....	635
Table 6.6:	Material balance of the plasma arc fuming process.....	636
Table 6.7:	Average throughput of zinc and consumables.....	636
Table 6.8:	Energy requirements of various zinc processes.....	637
Table 6.9:	Significance of potential emissions to air from zinc and cadmium production.....	638
Table 6.10:	Emissions to air from different RLE plants in Europe.....	638
Table 6.11:	Sulphur dioxide production from several zinc processes.....	639
Table 6.12:	Mass release of metals from some primary and secondary zinc plants in Europe.....	641
Table 6.13:	Typical gas-cleaning effluents before treatment.....	643
Table 6.14:	Typical waste water analyses.....	644
Table 6.15:	Potential waste water sources and treatment techniques.....	644
Table 6.16:	Residues from zinc processes.....	646
Table 6.17:	Example compositions of different types of residues.....	647
Table 6.18:	Zinc refining energy consumption in function of the applied residue treatment process ..	648
Table 6.19:	Eluate values of granulated ISF slag.....	648
Table 6.20:	Eluate values for acidic Waelz slag.....	649
Table 6.21:	Dust emissions from the feed preparation and the roaster.....	653
Table 6.22:	Dust removal at the dry gas cleaning section of the roasting plant (grate of ~ 120 m ²) before the wet gas cleaning section.....	654
Table 6.23:	Dust abatement in the wet gas cleaning system before conversion in the H ₂ SO ₄ plant.....	654
Table 6.24:	Emission data from the roasting plant during calcine milling, transport and storage.....	657
Table 6.25:	Emissions data from a settler at the neutral leach with and without a demister.....	661
Table 6.26:	Emissions data from the ventilation of leach tanks.....	661
Table 6.27:	Emissions data from the direct leach.....	662
Table 6.28:	Emissions data from the jarosite process in Plant A.....	662
Table 6.29:	Emissions data from the purification process.....	665
Table 6.30:	Emissions data from atmospheric coolers in the purification process.....	665
Table 6.31:	Emissions data from atmospheric cooling of the electrolyte.....	667
Table 6.32:	Emissions data from ventilation of the cell house building.....	669
Table 6.33:	Use options for liquid effluent flows from the RLE process.....	672
Table 6.34:	Typical waste flows and residues formed in the hydrometallurgical zinc process and treatment.....	675
Table 6.35:	Composition of residue from neutral leaching.....	676
Table 6.36:	Composition of Waelz oxide from the treatment of leaching residues.....	677
Table 6.37:	Composition of Waelz slag from the treatment of leaching residues.....	677
Table 6.38:	Emissions from the Waelz kiln process.....	678
Table 6.39:	Criteria for the acceptance of waste at landfills for non-hazardous wastes and typical results for Jarofix waste tested according to Council Decision 2003/33/CE.....	681
Table 6.40:	Criteria for the acceptance of waste at landfills for hazardous wastes and typical results for sulphidated waste (jarosite and sulphur residue).....	683
Table 6.41:	Leaching test criteria and obtained results for compacted iron residues.....	685
Table 6.42:	Emissions after abatement with Venturi scrubbers in pyrometallurgical zinc production.....	689
Table 6.43:	Emissions after abatement with bag filters in pyrometallurgical zinc production.....	690
Table 6.44:	Emissions after abatement with a semi-dry scrubber of a low-SO ₂ off-gas in pyrometallurgical zinc production.....	691
Table 6.45:	Emissions from an activated carbon filter in Plant N.....	693
Table 6.46:	Main gaseous components of the plasma arc fuming process.....	695
Table 6.47:	Main gaseous components of the zinc fuming process.....	696
Table 6.48:	Plant-specific data for stack emissions to air from Waelz furnaces.....	699
Table 6.49:	Emissions to air associated with the SDHL process before and after conversion.....	700
Table 6.50:	Effect of Waelz oxide washing.....	704
Table 6.51:	Waste water from the Waelz oxide washing process.....	704
Table 6.52:	Waste water from the Waelz oxide washing process.....	705
Table 6.53:	Diffuse and controlled emissions in zinc hydrometallurgical processes.....	706
Table 6.54:	Emissions from zinc smelting and casting in zinc foundries (part 1).....	708
Table 6.55:	Emissions from zinc smelting and casting in zinc foundries (part 2).....	708

Table 6.56:	Emissions from zinc powder production	709
Table 6.57:	Emissions from zinc dross milling in zinc foundries	711
Table 6.58:	Emissions to water from RLE plants (part 1)	716
Table 6.59:	Emissions to water from RLE plants (part 2)	717
Table 6.60:	Emissions to water from an ISF plant	717
Table 6.61:	Emissions to water from secondary zinc production using solvent extraction	718
Table 6.62:	Distribution of cadmium output from European zinc refinery plants	724
Table 6.63:	Emissions from cadmium melting, remelting, alloying, and holding and casting furnaces	725
Table 7.1:	Homogenisation categories of raw materials	729
Table 7.2:	Relevance of potential emissions to air from the major sources in precious metals production	741
Table 7.3:	Specific emissions to air from a range of precious metal production processes	742
Table 7.4:	Concentrations of emissions to air from three different processes in precious metal production	743
Table 7.5:	Captured emissions to air from two PM plants for different process steps	743
Table 7.6:	Sources of potential emissions to water from precious metals production	744
Table 7.7:	Emissions to water from five large plants	744
Table 7.8:	Emissions to water from two PM plants	745
Table 7.9:	Example of filter cake waste quantities	745
Table 7.10:	Dust emissions from PM Plant 221	747
Table 7.11:	Dust emissions from the slag crushing station in PM Plant 117	748
Table 7.12:	Dust emissions from PM Plant 221	750
Table 7.13:	Dust emissions from PM Plant 2426	750
Table 7.14:	Emissions from a rotary furnace in PM Plant 112	751
Table 7.15:	Emissions from PM Plant 117	754
Table 7.16:	Emissions from the central ventilation system in PM Plant 117	755
Table 7.17:	Dust emissions from secondary gases in PM Plant 121	756
Table 7.18:	Dust emissions from several sources (cupellation furnace and secondary gases) in PM Plant 121	756
Table 7.19:	Dust emissions in PM Plant 27	757
Table 7.20:	Dust emissions in PM Plant 219	757
Table 7.21:	Emissions from process gases in PM Plant 2113	757
Table 7.22:	Emissions from building ventilation air in PM Plant 2113	758
Table 7.23:	Emissions from scrubbing processes in PM Plant 221	766
Table 7.24:	Emissions in PM Plant 2113	767
Table 7.25:	Emissions from scrubbing processes in PM Plant 113	767
Table 7.26:	Emissions from scrubbing processes in PM Plant 112	768
Table 7.27:	Emissions from sweep incineration in PM Plant 112	771
Table 7.28:	Emissions from spent catalyst incineration in PM Plant 102	773
Table 7.29:	Emissions to water from PM Plant 221	775
Table 7.30:	Concentration of the final filtrate liquor generated in PM Plant 221	775
Table 7.31:	Emissions to water from PM Plant 113	776
Table 7.32:	Emissions to water from PM Plant 117	776
Table 7.33:	Emissions to water from PM Plant 1019	777
Table 7.34:	Emissions to water from PM Plant 205	778
Table 8.1:	Raw materials for the production of ferro-silicon, silicon metal and silico-calcium	791
Table 8.2:	Fines generation due to free fall	791
Table 8.3:	Typical amounts of metal oxides in secondary raw materials	812
Table 8.4:	Summary of the smelting systems used in the ferro-alloy industry	816
Table 8.5:	Gross consumption data for the production of ferro-chrome as specific input of raw materials per tonne of alloy produced	820
Table 8.6:	Consumption data for the recovery of ferro-alloys from steel mill residues as specific input of raw materials per tonne of recovered metal	821
Table 8.7:	Consumption data for the production of ferro-silicon, silicon and silico-calcium as specific input of raw materials per tonne of alloy produced	821
Table 8.8:	Consumption data for the production of manganese ore sinter, ferro-manganese and silico-manganese as specific input of raw materials per tonne of alloy produced	822
Table 8.9:	Consumption data for the production of ferro-nickel alloy as specific input of raw materials per tonne of alloy produced	823
Table 8.10:	Consumption data for the production of special ferro-alloys as specific input of raw materials per tonne of alloy produced	823
Table 8.11:	Dust emissions from the production of ferro-chrome based on the production of one tonne of alloy	825

Table 8.12:	Dust emissions from the production of ferro-silicon and silicon metal based on the production of one tonne of alloy	826
Table 8.13:	Dust emissions from the production of ferro-manganese and silico-manganese based on the production of one tonne of alloy	827
Table 8.14:	Dust emissions to air (after abatement) from the production of ferro-alloys	827
Table 8.15:	Ferro-nickel emissions to air	828
Table 8.16:	Sources of ferro-nickel emissions	828
Table 8.17:	Emissions from the production of ferro-vanadium and ferro-molybdenum	828
Table 8.18:	Emissions to air (after abatement) when producing bulk ferro-alloys	831
Table 8.19:	Emission of metals from ferro-manganese and silico-manganese production	832
Table 8.20:	Emissions to air from primary ferro-nickel production	832
Table 8.21:	Characterisation of the emissions to air from primary ferro-nickel production	833
Table 8.22:	Emission from a secondary ferro-alloys production process	833
Table 8.23:	Emissions to water from the recovery of ferro-alloys from steel mill residues using the plasma dust process with a wet scrubber followed by a wet ESP as the abatement technique	835
Table 8.24:	Emissions to water from roasting molybdenite and ferro-molybdenum in one plant	835
Table 8.25:	Generation, recycling, reuse and discharge of ferro-alloy slag	836
Table 8.26:	Generation, recycling, reuse and discharge of dust and sludge from the air emissions abatement system	838
Table 8.27:	Energy recovery efficiency for silicon and ferro-silicon furnaces	840
Table 8.28:	Overview of energy recovery in the Norwegian ferro-alloys industry	841
Table 8.29:	Energy reuse when producing bulk ferro-alloys	841
Table 8.30:	Dust emissions from the reception, handling and storage of primary materials	843
Table 8.31:	Dust emissions from crushing and grinding of raw materials	844
Table 8.32:	Dust emissions from metering, mixing and blending	845
Table 8.33:	Emissions from briquetting, pelletising and sintering	847
Table 8.34:	Emissions from open submerged arc furnaces (concentrations)	854
Table 8.35:	Emissions from open submerged arc furnaces (mass loads)	856
Table 8.36:	Emissions from semi-closed submerged arc furnaces using bag filters	858
Table 8.37:	Emissions from semi-closed submerged arc furnaces using bag filters with adsorbent injection	859
Table 8.38:	Emissions from closed submerged arc furnaces using wet scrubbers (concentrations)	861
Table 8.39:	Emissions from closed submerged arc furnaces using wet scrubbers (mass loads)	862
Table 8.40:	Correlation between concentrations and mass loads in plants using closed furnaces	862
Table 8.41:	Emissions from closed submerged arc furnaces using wet scrubbers followed by mercury abatement techniques	863
Table 8.42:	Emissions from closed submerged arc furnaces using bag filters	863
Table 8.43:	Emissions from the closed plasma dust process	865
Table 8.44:	Emissions from refractory-lined crucibles	868
Table 8.45:	Origin of dust in the process	869
Table 8.46:	Dust emissions from tapping	872
Table 8.47:	Dust emissions from casting	874
Table 8.48:	Recovery of very fine products in the crushing and screening station of a ferro-chrome plant	875
Table 8.49:	Dust emissions from post-furnace size reduction	876
Table 8.50:	Dust emissions from packaging	878
Table 8.51:	Emissions to water from Plant AB (ferro-chrome)	881
Table 8.52:	Emissions to water from Plant AC (ferro-chrome)	882
Table 8.53:	Emissions to water from Plant N (ferro-silicon)	882
Table 8.54:	Emissions to water from Plant U (silicon)	883
Table 8.55:	Emissions to water from Plant V (silicon)	883
Table 8.56:	Emissions to water from Plant J (HC FeMn)	883
Table 8.57:	Emissions to water from Plant Z (HC FeMn)	884
Table 8.58:	Emissions to water from Plant K (LC FeMn + MC FeMn + SiMn)	884
Table 8.59:	Emissions to water from Plant M (FeMn + SiMn)	885
Table 8.60:	Emissions to water from Plant O (LC SiMn + LC FeMn + MC FeMn)	885
Table 8.61:	Emissions to water from Plant I (LC SiMn + HC SiMn)	886
Table 8.62:	Emissions to water from Plant Y (silico-manganese)	886
Table 8.63:	Emissions to water from Plant B (molybdenite roaster)	887
Table 8.64:	Emissions to water from Plant X (roasting and ferro-molybdenum)	887
Table 8.65:	Detailed features of ferro-chrome slag	889
Table 8.66:	Examples of heat recovery from semi-closed furnaces	891

Table 9.1:	Composition of some ores.....	897
Table 9.2:	Processes used in the EU-28	899
Table 9.3:	Significance of potential emissions to air from cobalt and nickel production.....	913
Table 9.4:	Sulphur dioxide production from some nickel and cobalt processes.....	914
Table 9.5:	Dust and metal emissions from some European processes	915
Table 9.6:	Emissions to air from some process stages of cobalt production	915
Table 9.7:	Significance of secondary fume capture and diffuse emissions	917
Table 9.8:	Typical composition of gas-cleaning effluents.....	918
Table 9.9:	Summary of potential waste water sources and treatment options.....	919
Table 9.10:	Examples of waste water analyses	919
Table 9.11:	Mass emissions of nickel per tonne produced for European processes	920
Table 9.12:	Example compositions of different types of residues.....	920
Table 9.13:	Example compositions of typical nickel slags.....	921
Table 9.14:	Some treatment or reuse options for solid residues from nickel and cobalt production processes	921
Table 9.15:	Dust emissions from loading and on-site transport in a nickel plant.....	923
Table 9.16:	Emissions from a rotary dryer in a nickel production plant	926
Table 9.17:	Emissions from the DON process	929
Table 9.18:	Emissions from an EAF	931
Table 9.19:	Emissions from slag taphole and matte taphole granulation gas	931
Table 9.20:	Emissions from sulphate-based atmospheric and pressure leaching	934
Table 9.21:	Emissions from atmospheric and pressure leaching using chlorine gas	934
Table 9.22:	Emissions of VOCs from solvent extraction refining	935
Table 9.23:	Dust emissions from the nickel matte refining process (chlorine route) in Plant B	936
Table 9.24:	Emissions from the electrowinning process	938
Table 9.25:	Emissions from the carbonyl process.....	940
Table 9.26:	Emissions from hydrogen reduction processes when producing nickel powder and briquettes	942
Table 9.27:	Emissions to water from Plant D.....	945
Table 9.28:	Emissions to water from Plant A.....	946
Table 9.29:	Emissions from Plant C.....	947
Table 9.30:	Emissions from Plant B.....	947
Table 9.31:	Emissions from Plant E.....	948
Table 9.32:	Typical waste flows and residues formed in nickel production at smelting and refinery stages	950
Table 9.33:	Emissions of the Kokkola cobalt plant.....	955
Table 10.1:	Overview of materials and process steps for carbon and graphite products.....	959
Table 10.2:	Reporting conventions for PAH.....	970
Table 10.3:	Relative significance of potential emissions to air from carbon and graphite production.....	972
Table 10.4:	Emissions from electrically calcined coke and coal	972
Table 10.5:	Emissions from natural gas-calcined coke and coal	972
Table 10.6:	Examples of emission ranges for a number of carbon and graphite production processes	973
Table 10.7:	Rate of destruction of some PAH in a RTO	974
Table 10.8:	Example of emissions from RTOs operating in carbon and graphite baking and rebaking processes	975
Table 10.9:	Emissions range based on plant-specific data from handling, storage and transportation	978
Table 10.10:	Emissions range based on plant-specific data for a bag filter in the mixing and shaping stage	981
Table 10.11:	Emissions range based on plant-specific data for a dry scrubber followed by bag filter in the mixing and shaping stage	981
Table 10.12:	Emissions range based on plant-specific data for an activated coke filter in the mixing and shaping stage	981
Table 10.13:	Emissions range based on plant-specific data for a thermal oxidiser in the mixing and shaping stage	981
Table 10.14:	Emissions range based on plant-specific data for a regenerative thermal oxidiser in the mixing and shaping stage	981
Table 10.15:	Emissions range based on plant-specific data for the handling of the coke packing material.....	984
Table 10.16:	Emissions range based on plant-specific data for an ESP in the baking stage	984
Table 10.17:	Emissions range based on plant-specific data for a thermal oxidiser in the baking stage	984
Table 10.18:	Emissions range based on plant-specific data for a regenerative thermal oxidiser in the baking stage.....	985

Table 10.19: Emissions range based on plant-specific data for a thermal oxidiser and wet scrubber in the baking stage	985
Table 10.20: Emissions range based on plant-specific data for an ESP and regenerative thermal oxidiser in the baking stage	985
Table 10.21: Emissions range based on plant-specific data for a RTO and dry scrubber in the baking stage	985
Table 10.22: Emissions range based on plant-specific data for an ESP and activated coke filter in the baking stage	986
Table 10.23: Emissions range based on plant-specific data for a bag filter in the rebaking stage	986
Table 10.24: Emissions range based on plant-specific data for a thermal oxidiser in the rebaking stage	986
Table 10.25: Emissions range based on plant-specific data for a dry scrubber in the impregnation stage	989
Table 10.26: Emissions range based on plant-specific data for a thermal oxidiser in the impregnation stage	989
Table 10.27: Emissions range based on plant-specific data for a biofilter and bioscrubber in the impregnation stage	990
Table 10.28: Emissions range based on plant-specific data for special impregnation processes	990
Table 10.29: Emissions range based on plant-specific data for a bag filter in the graphitising stage	991
Table 10.30: Emissions range based on plant-specific data for a wet scrubber in the graphitising stage	991
Table 10.31: Emissions range based on plant-specific data for a bag filter in the machining stage	992
Table 11.1: BAT-associated emission levels for mercury emissions to air (other than those that are routed to the sulphuric acid plant) from a pyrometallurgical process using raw materials containing mercury	1009
Table 11.2: BAT-associated emission levels for direct emissions to a receiving water body from the production of copper, lead, tin, zinc (including the waste water from the washing stage in the Waelz kiln process), cadmium, precious metals, nickel, cobalt and ferro-alloys ..	1012
Table 11.3: BAT-associated emission levels for dust emissions to air from copper production	1020
Table 11.4: BAT-associated emission levels for emissions to air of TVOC from the pyrolytic treatment of copper turnings, and the drying, smelting and melting of secondary raw materials	1021
Table 11.5: BAT-associated emission levels for PCDD/F emissions to air from the pyrolytic treatment of copper turnings, smelting, melting, fire refining and converting operations in secondary copper production	1022
Table 11.6: BAT-associated emission levels for SO ₂ emissions to air (other than those that are routed to the sulphuric acid or liquid SO ₂ plant or power plant) from primary and secondary copper production	1023
Table 11.7: BAT-associated emission levels for dust and BaP (as an indicator of PAH) emissions to air from a paste plant	1027
Table 11.8: BAT-associated emission levels for dust, BaP (as an indicator of PAH) and fluoride emissions to air from a baking plant in an anode production plant integrated with a primary aluminium smelter	1027
Table 11.9: BAT-associated emission levels for dust, BaP (as an indicator of PAH) and fluoride emissions to air from a baking plant in a stand-alone anode production plant	1028
Table 11.10: BAT-associated emission levels for dust from the storage, handling and transport of raw materials	1029
Table 11.11: BAT-associated emission levels for dust and fluoride emissions to air from electrolytic cells	1030
Table 11.12: BAT-associated emission levels for the total emissions of dust and fluoride to air from the electrolysis house (collected from the electrolytic cells and roof vents)	1030
Table 11.13: BAT-associated emission levels for dust emissions to air from melting and molten metal treatment and casting in primary aluminium production	1031
Table 11.14: BAT-associated emission levels for SO ₂ emissions to air from electrolytic cells	1031
Table 11.15: BAT-associated emission levels for dust emissions to air from the swarf drying and the removal of oil and organic compounds from the swarf, from the crushing, milling and dry separation of non-metallic constituents and metals other than aluminium, and from the storage, handling and transport in secondary aluminium production	1034
Table 11.16: BAT-associated emission levels for dust emissions to air from furnace processes such as charging, melting, tapping and molten metal treatment in secondary aluminium production	1035
Table 11.17: BAT-associated emission levels for dust from remelting in secondary aluminium production	1035

Table 11.18: BAT-associated emission levels for emissions to air of TVOC and PCDD/F from the thermal treatment of contaminated secondary raw materials (e.g. swarf) and from the melting furnace.....	1036
Table 11.19: BAT-associated emission levels for HCl, Cl ₂ and HF emissions to air from the thermal treatment of contaminated secondary raw materials (e.g. swarf), the melting furnace, and remelting and molten metal treatment	1036
Table 11.20: BAT-associated emission levels for dust emissions to air from crushing and dry milling associated with the salt slag recovery process.....	1037
Table 11.21: BAT-associated emission levels for gaseous emissions to air from wet milling and leaching from the salt slag recovery process.....	1038
Table 11.22: BAT-associated emission levels for dust emissions to air from raw material preparation in primary and secondary lead and/or tin production	1041
Table 11.23: BAT-associated emission levels for dust emissions to air from battery preparation (crushing, screening and classifying)	1041
Table 11.24: BAT-associated emission levels for dust and lead emissions to air (other than those that are routed to the sulphuric acid or liquid SO ₂ plant) from charging, smelting and tapping in primary and secondary lead and/or tin production	1041
Table 11.25: BAT-associated emission levels for dust and lead emissions to air from remelting, refining and casting in primary and secondary lead and/or tin production	1042
Table 11.26: BAT-associated emission levels for TVOC emissions to air from the raw material drying and smelting process in secondary lead and/or tin production.....	1042
Table 11.27: BAT-associated emission levels for PCDD/F emissions to air from the smelting of secondary lead and/or tin raw materials	1043
Table 11.28: BAT-associated emission levels for SO ₂ emissions to air (other than those that are routed to the sulphuric acid or liquid SO ₂ plant) from charging, smelting and tapping in primary and secondary lead and/or tin production	1044
Table 11.29: BAT-associated emission levels for dust emissions to air from the handling and storage of raw materials, dry roaster feed preparation, dry roaster feeding and calcine processing	1047
Table 11.30: BAT-associated emission levels for zinc and sulphuric acid emissions to air from leaching, purification and electrolysis and for arsane and stibane emissions from purification	1047
Table 11.31: BAT-associated emission levels for dust emissions to air (other than those that are routed to the sulphuric acid plant) from pyrometallurgical zinc production	1049
Table 11.32: BAT-associated emission levels for SO ₂ emissions to air (other than those that are routed to the sulphuric acid plant) from pyrometallurgical zinc production	1049
Table 11.33: BAT-associated emission levels for dust emissions to air from pelletising and slag processing.....	1050
Table 11.34: BAT-associated emission levels for dust emissions to air from the melting of metallic and mixed metallic/oxidic streams, and from the slag fuming furnace and the Waelz kiln	1050
Table 11.35: BAT-associated emission levels for emissions to air of TVOC and PCDD/F from the melting of metallic and mixed metallic/oxidic streams, and from the slag fuming furnace and the Waelz kiln	1050
Table 11.36: BAT-associated emission levels for emissions of HCl and HF to air from the melting of metallic and mixed metallic/oxidic streams, and from the slag fuming furnace and the Waelz kiln	1051
Table 11.37: BAT-associated emission levels for dust emissions to air from the melting, alloying and casting of zinc ingots and zinc powder production	1052
Table 11.38: BAT-associated emission levels for dust and cadmium emissions to air from pyrometallurgical cadmium production and the melting, alloying and casting of cadmium ingots	1053
Table 11.39: BAT-associated emission levels for dust emissions to air from all dusty operations, such as crushing, sieving, mixing, melting, smelting, incineration, calcining, drying and refining	1056
Table 11.40: BAT-associated emission levels for NO _x emissions to air from a hydrometallurgical operation involving dissolving/leaching with nitric acid	1057
Table 11.41: BAT-associated emission levels for SO ₂ emissions to air (other than those that are routed to the sulphuric acid plant) from a melting and smelting operation for the production of Doré metal, including the associated incineration, calcining and drying operations	1057
Table 11.42: BAT-associated emission levels for SO ₂ emissions to air from a hydrometallurgical operation, including the associated incineration, calcining and drying operations	1058

Table 11.43: BAT-associated emission levels for HCl and Cl ₂ emissions to air from a hydrometallurgical operation, including the associated incineration, calcining and drying operations	1058
Table 11.44: BAT-associated emission levels for NH ₃ emissions to air from a hydrometallurgical operation using ammonia or ammonium chloride	1058
Table 11.45: BAT-associated emission levels for PCDD/F emissions to air from a drying operation where the raw materials contain organic compounds, halogens or other PCDD/F precursors, from an incineration operation, and from a calcining operation	1059
Table 11.46: BAT-associated emission levels for dust emissions to air from ferro-alloys production	1063
Table 11.47: BAT-associated emission levels for PCDD/F emissions to air from a furnace producing ferro-alloys.....	1063
Table 11.48: BAT-associated emission levels for dust emissions to air from the handling and storage of raw materials, material pretreatment processes (such as ore preparation and ore/concentrate drying), furnace charging, smelting, converting, thermal refining and nickel powder and briquette production when processing sulphidic ores.....	1066
Table 11.49: BAT-associated emission levels for nickel and chlorine emissions to air from the atmospheric or pressure leaching processes	1066
Table 11.50: BAT-associated emission levels for nickel emissions to air from the nickel matte refining process using ferric chloride with chlorine	1067
Table 11.51: BAT-associated emission levels for dust and BaP (as an indicator of PAH) emissions to air from the storage, handling and transportation of coke and pitch, and mechanical processes (such as grinding) and graphitising and machining	1069
Table 11.52: BAT-associated emission levels for dust and BaP (as an indicator of PAH) emissions to air from the production of green paste and green shapes.....	1070
Table 11.53: BAT-associated emission levels for dust and BaP (as an indicator of PAH) emissions to air from baking and rebaking.....	1070
Table 11.54: BAT-associated emission levels for dust and BaP (as an indicator of PAH) emissions to air from impregnation	1071
Table 11.55: BAT-associated emission levels for TVOC emissions to air from mixing, baking and impregnation.....	1071
Table 12.1: Key milestones of the review process of the BREF for the Non-Ferrous Metals Industries	1077
Table 12.2: Split views	1079
Table 13.1: Typical furnace applications.....	1084
Table 13.2: Drying, roasting, sintering and calcining furnaces	1112
Table 13.3: Smelting and converting furnaces.....	1113
Table 13.4: Melting furnaces	1114
Table 13.5: Yearly average metal concentrations in ambient air from a complex industrial area which includes a primary zinc smelter.....	1118
Table 13.6: Environmental concentrations of some metals in PM ₁₀ at sampling stations in Flanders	1121
Table 13.7: Some currency exchange rates.....	1125
Table 13.8: Primary copper smelter/acid plant complexes	1128
Table 13.9: Rönnskär Project.....	1129
Table 13.10: Secondary copper smelters	1129
Table 13.11: Electrolytic copper refineries.....	1130
Table 13.12: Copper wire rod plants.....	1130
Table 13.13: Lead processes.....	1132
Table 13.14: Zinc processes.....	1132
Table 13.15: Zinc and lead processes	1132
Table 13.16: Zinc residues.....	1133
Table 13.17: Indirect gas cooling - energy recovery.....	1133
Table 13.18: Dry ESP	1133
Table 13.19: Bag filter.....	1134
Table 13.20: Wet ESP.....	1134
Table 13.21: Wet ESP.....	1135
Table 13.22: Afterburner, reactor and bag filter	1136
Table 13.23: Afterburner	1137
Table 13.24: Wet desulphurisation	1138
Table 13.25: Semi-dry scrubber.....	1139
Table 13.26: Activated carbon filter	1140
Table 13.27: SCR.....	1141
Table 13.28: Dry scrubber and bag filter	1143
Table 13.29: Semi-dry scrubber and bag filter	1144

Table 13.30: Semi-dry scrubber and bag filter	1145
Table 13.31: Wet scrubber and ESP	1146
Table 13.32: Semi-dry scrubber, activated carbon injection and bag filter	1147
Table 13.33: Cost-effectiveness according to NeR methodology	1148
Table 13.34: Copper smelter sulphuric acid plants	1149
Table 13.35: Sulphuric acid plants	1150
Table 13.36: Weak acid neutralisation	1150

SCOPE

This BREF for the non-ferrous metal industries covers certain industrial activities specified in Section 2.5 (a) and (b) of Annex I to Directive 2010/75/EU, namely:

'2.5. Processing of non-ferrous metals:

(a) production of non-ferrous crude metals from ore, concentrates or secondary raw materials by metallurgical, chemical or electrolytic processes;

(b) melting, including the alloyage, of non-ferrous metals, including recovered products and operation of non-ferrous metals foundries, with a melting capacity exceeding 4 tonnes per day for lead and cadmium or 20 tonnes per day for all other metals.'

There are many similarities between primary and secondary production of non-ferrous metals and in some cases it is impossible to distinguish between the techniques used. In some cases, primary production of non-ferrous metals includes the integration of secondary raw material into common production processes to save energy, minimise production costs and recover important materials. Secondary production of non-ferrous metals includes the production of metal from secondary raw materials (including scrap and metal-bearing materials) and the remelting and alloying processes. This document covers the techniques for the production of both primary and secondary non-ferrous metals. Mining and ore treatment at the mine site are not covered.

The production of carbon and graphite anodes (Section 6.8 of Annex I to Directive 2010/75/EU (IED)) is included because of the similarity of part of the process to the production of anodes at some aluminium smelters as an integral part of the production process.

Activities under Section 2.1 of Annex I to the IED – sintering and roasting – are covered by this document in two parts of the Annex:

- those which are part of Section 2.5 (a) processes to produce the metal;
- where roasting and sintering are carried out independently, for example the roasting of molybdenum sulphide.

The production of radioactive metals is excluded from this document. The production of components such as semiconductors is also excluded.

There are interfaces with the chemical sector but there are specific issues and differences that should be taken into account when these processes are associated with metal production, or when metal compounds are produced as by-products of the production of metal. The following processes are included in the scope of this work.

- The production of zinc oxide from fume during the production of other metals.
- The production of nickel compounds from liquors produced during the production of a metal.
- The production of CaSi and Si which takes place in the same furnace as the production of ferro-silicon.
- The production of aluminium oxide from bauxite prior to the production of primary aluminium. This is an integral part of the production of the metal when performed at the smelter and is therefore included in this document.
- The recycling of aluminium salt slag when integrated with non-ferrous metals production.

The rolling, drawing and pressing of non-ferrous metals, when directly integrated with the production of metal, are therefore included in this document. Foundry processes are not included in this document and are covered in the BREF for the Smitheries and Foundries Industry [428, COM 2005]

Scope

In addition to basic manufacturing activities, this document covers the associated activities which could have an effect on emissions or pollution. Thus, this document includes activities from the preparation of raw materials to the dispatch of the finished products.

The main operations covered are:

- raw materials storage and preparation;
- fuels storage and preparation;
- the production processes, i.e. the pyrometallurgical and hydrometallurgical processes;
- emission prevention and reduction techniques;
- products, storage and preparation.

It should be noted that in 2000, for the industrial sectors covered by the NFM BREF 2001, data were collected for the EU-15. Furthermore in 2008 and in 2012, information and data have been updated for the EU-27 as far as possible.

Other reference documents which are relevant for the activities covered in this document are the following:

Reference documents	Activity
Energy Efficiency (ENE)	General energy efficiency
Common Waste Water and Waste Gas Treatment/Management Systems in the Chemical Sector (CWW)	Waste water treatment techniques to reduce emissions of metals to water
Large Volume Inorganic Chemicals - Ammonia, Acids and Fertiliser (LVIC-AAF)	Sulphuric acid production
Industrial Cooling Systems (ICS)	Industrial cooling systems, e.g. cooling towers, plate heat exchangers
Emissions from Storage (EFS)	Storage and handling of materials
Economics and Cross-Media Effects (ECM)	Economics and cross-media effects of techniques
Monitoring of emissions to air and water from IED installations (ROM)	Monitoring of emissions to air and water
Waste Treatment (WT)	Waste handling and treatment
Large Combustion Plants (LCP)	Generation of steam and electricity by combustion plants with a rated thermal input of $\geq 50 \text{ MW}_{\text{th}}$
Surface treatment using organic solvents (STS)	Non-acid pickling of copper rod, copper semis and copper alloy
Surface treatment of metals and plastics (STM)	Acid pickling of copper rod, copper semis and copper alloy

The scope of this document does not include matters that only concern safety in the workplace or the safety of products because these matters are not covered by the Directive. They are discussed only where they affect matters within the scope of the Directive.

1 GENERAL INFORMATION

1.1 Industry overview

The European non-ferrous metals industry has an economic and strategic importance greater than its employment, capital and turnover statistics indicate. For example, high-purity copper is essential for electricity generation and distribution, and small amounts of nickel improve the corrosion resistance of steel.

Non-ferrous metals and their alloys therefore lie at the heart of modern life and many high-technology developments, particularly in the energy generation, computing, electronic, telecommunications and transport industries depend upon them.

1.1.1 Non-ferrous metals and alloys

All the non-ferrous metals considered in this document have their own individual properties and applications. In several cases however, e.g. copper and aluminium, alloys are used in more applications than pure metals because they can be designed to have a specific strength, toughness, etc. to meet the requirements of particular applications.

Metals are inherently recyclable and can be recycled time after time without losing any of their properties. They thus make a significant contribution to sustainable development. It is normally not possible to distinguish between refined metal that has been produced from primary raw materials and metal that has been produced from secondary raw materials (e.g. scrap).

1.1.2 Scope of the industry

The output of the industry is derived from a variety of primary and secondary raw materials. Primary raw materials are derived from ores that are mined and then further treated, for example by washing and jigging, to reduce waste material before they are metallurgically processed to produce crude metal. The treatment of ores is carried out close to the mines as, increasingly, is metal production. Secondary raw materials are indigenous scrap and residues.

Most metal concentrates are imported into Europe from a variety of sources worldwide. The importance of using indigenous secondary raw materials such as scrap metal and other residues cannot be emphasised enough. Recycled metal constitutes an important component of the raw material supplies of the industry.

In the copper sector, secondary raw materials account for the production of about 40 % of EU copper but in some cases, such as brass rods, the product is made entirely from recycled copper and brass, with only a small input of primary zinc. When copper cathodes are produced from recycled materials there are savings of approximately 650 000 tonnes of CO₂ because specific direct emissions of secondary smelters are four times lower than those of primary smelters.

In the aluminium sector, the production and refining of secondary aluminium are also much less demanding in terms of energy, accounting for a consumption per kg of Al produced of about 5 % of the energy needed to produce primary aluminium.

The output of the industry is either refined metal or what is known as semis manufactures, i.e. metal and metal alloy cast ingots or wrought shapes, extruded shapes, foils, strips, rods, etc.

The non-ferrous foundries that produce cast metal products have not been included in this document but are covered by the Smitheries and Foundries Industry BREF. The collection,

sorting and supply of secondary raw materials for the industry lies within the metal recycling industry, which is also not considered in this document.

Although an apparent contradiction in terms, the production of ferro-alloys, which are mainly used as master alloys in the iron and steel industry, is considered part of the non-ferrous metals industry. Their alloying elements, i.e. refractory metals, chromium, silicon, manganese and nickel, are all non-ferrous metals.

The precious metals sector is also considered part of the non-ferrous metals industry for the purposes of this document.

1.1.3 Structure of the industry

The structure of the industry varies by metal. There are no companies that produce all or even a majority of non-ferrous metals although there are a few pan-European companies producing several metals, e.g. copper, lead, zinc and cadmium.

The size of the companies producing non-ferrous metals and non-ferrous metal alloys in Europe varies from a few employing more than 5000 people to a large number having between 50 and 200 employees.

Ownership varies between pan-European and national metals groups, industrial holdings groups, stand-alone public companies and private companies.

1.1.4 Economics of the industry

The key statistics of the European non-ferrous metals industry as defined for the purpose of this document are:

- turnover: EUR 120 billion (77 % fabrication/transformation, 21 % refineries, 2 % mining);
- jobs (direct): 500 000 (direct) (> 2 million indirect);
- world market position: 1/5 of global production:
 - o 30 % of global first stage processing,
 - o 22 % of global refined metal production,
 - o 4 % of global mining production. [429, [Eurometaux 2016](#)]

Many refined non-ferrous metals are international commodities. The major metals (aluminium, copper, lead, nickel, tin and zinc) are traded on one of two futures markets, the London Metal Exchange or COMEX in New York. In addition to the New York Commodity Exchange (NYMEX), precious metals can also be traded on the London Bullion Market (LBMA), the Tokyo Commodity Exchange (TOCOM), the Zurich Gold Pool, the Dubai Multi Commodities Centre (DMCC) and the Bullion Vault. The collectively named 'minor' metals have no central marketplace; price levels are imposed either by producers or by merchants trading on the free market. In most applications, a particular non-ferrous metal is in competition with other materials, notably ceramics, plastics and other ferrous and non-ferrous metals.

The profitability of each metal or metals group, and thus the economic viability of the industry both absolutely and on a short-term basis, depends upon a wide range of other economic factors such as the agreed processing (treatment and refining) fee applied in some sectors between the mine and the smelter.

The general economic rule applies however, i.e. the nearer a material or product comes to global market conditions and international commodity status, the lower the return on the capital invested.

1.1.5 Environmental performance

There has been a steady improvement in the environmental performance and energy efficiency of the industry over the last 30 years since the adoption of Directive 84/360/EEC on the combating of air pollution from industrial plants.

The recycling rate of the industry is very high. Metals are often produced at lower energy costs using the recycling route. For copper for example, secondary smelting compared to primary smelting emits 4 times less carbon dioxide, consumes 3 times less electricity and 2.5 times less fuel for combustion. Additional efforts to recycle low-quality, metal-bearing residues are however required to protect the environment and improve energy efficiency even further.

1.2 Copper and its alloys

1.2.1 General information

Copper has been used for many centuries; it has a very high thermal and electrical conductivity and is relatively corrosion-resistant. Used copper can be recycled without loss of quality. Copper is frequently alloyed with Zn, Sn, Ni, Al and other metals to make a range of brasses and bronzes [35, COM 1997].

Copper production is based on grade A copper cathodes, i.e. 99.95 % Cu. The grade A designation comes from the London Metal Exchange vocabulary for cathodes and refers to a British Standard. This has been replaced by a European CEN standard, EN 1978, where the quality is designated as Cu CATH1 or, in the new European alphanumeric system, CR001A.

The maximum tolerable impurities in percentages are in Table 1.1 as follows:

Table 1.1: Maximum tolerable impurities

Element/s	Percentage (%)
Ag	0.0025
As	0.0005
Bi	0.00020
Fe	0.0010
Pb	0.0005
S	0.0015
Sb	0.0004
Se	0.00020
Te 0.00020 with As+Cd+Cr+Mn+P+Sb	0.0015
Bi+Se+Te	0.0003
Se+Te	0.0003
Ag+As+Bi+Cd+Co+Cr+Fe+Mn+Ni+P+Pb+S+Sb+Se+Si+Sn+Te+Zn	0.0065

1.2.2 Sources of materials

Refined copper is produced from primary and secondary raw materials by a relatively small number of copper refineries; their product is copper cathode. This is melted, alloyed and further processed to produce rods, profiles, wires, sheets, strips, tubes, etc. This step may be integrated with the refinery but is frequently carried out at another site.

Important copper mine production can be found in Poland (KGHM Polska Miedź S.A. in Lubin, Polkowice-Sieroszowice and Rudna) with 426 700 tonnes of copper extracted in 2011. Other sizeable EU mining countries are Spain (start-up of mining and hydrometallurgical production of copper cathodes at Las Cruces in 2009, with a capacity of 72 000 tonnes of copper), Portugal (start-up of mining at Neves-Corvo in 1989, with 80 000 tonnes of copper in 2011), Sweden (83 000 tonnes) and Bulgaria (115 000 tonnes) [363, Brown et al. 2013].

With about 835 000 tonnes of copper extracted from domestic ores in 2011, the EU-28 countries account for around 5 % of the total worldwide copper mine output. [363, Brown et al. 2013].

1.2.3 Production and use

The products of the refineries are the major raw materials for the manufacturers of semi-fabricated products. With an output twice that of EU refinery output, the EU-28 semis manufacturers directly use a significant amount of scrap in the range of one million tonnes per year. They must also turn to the international market to secure adequate supplies of refined copper. It is estimated that around 60 % of their raw materials come from primary sources, the remaining 40 % from the direct use of scrap and other secondary materials [238, ECI 2012].

The 2005 output of the copper and copper alloy semis industry in the EU-27 exceeded 5.2 million tonnes (about 4.8 million tonnes copper equivalent). This represented more than one quarter of global production. Despite this relatively large percentage, this was the lowest level this century, 10 % lower than the average of the previous six years, and 20 % less than the peak in 2000. Germany, Italy and France account for about two thirds of the EU-28 output. The range of products supplied by the semis manufacturers is very wide, but consists primarily of rods, profiles, wires, sheets, strips and tubes. Applications are equally diverse, with semis used in sectors such as electrical engineering, automobiles, construction, plumbing, machinery, shipbuilding, aircraft, precision instruments, watches and clocks, etc.

The production capacity of the EU semis industry exceeds demand. While figures from 2005 show the EU to be a net exporter of about 500 000 tonnes per year, this overcapacity makes the industry, and its economic well-being, very sensitive to cyclical movements in demand.

The electrical wire rod sector accounts for around half of semis production. Some 20 companies, employing around 3000 people in total, are involved in this sector. Whilst part of this is the integrated downstream output of copper refiners (e.g. KGHM and Aurubis AG), a significant part is upstream integration by wire and cable producers (e.g. Nexans and Prysmian). Figure 1.1 shows the worldwide production of copper in 2005, and semis include billets, cakes, ingots and plates, as well as wire rods.

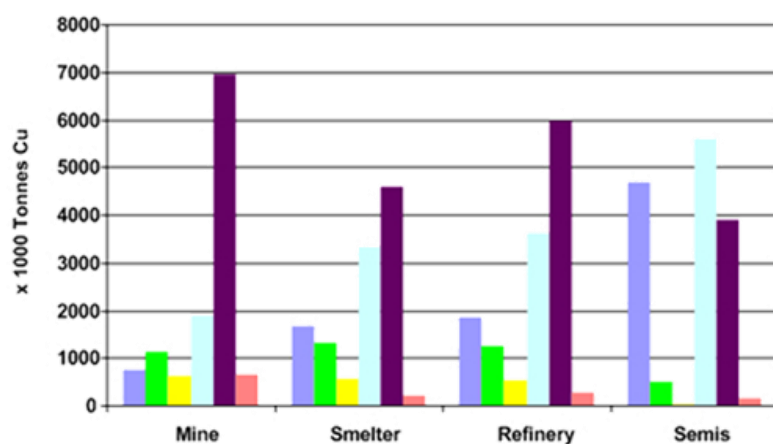

EU	751	1662	1854	4700
Non-EU	1135	1310	1271	500
Africa	642	562	531	20
Asia	1884	3330	3630	5600
America	6952	4586	6000	3900
Oceania	672	208	271	150

Source: [238, ECI 2012].

Figure 1.1: Worldwide copper production in 2005

Far more companies participate in the other copper semis manufacturing industries. About 80 companies, employing some 35 000 people throughout the EU-28, produce copper and copper alloy rods, bars, wires, sections, tubes, plates, sheets and strips. This sector is led by two large companies, KME Group SpA (IT), with major manufacturing activities in France, Germany, Italy and Spain, and Wieland-Werke (DE), with operations in Austria, Germany and the UK. The semis activities of Boliden (SE) were acquired by Outokumpu (FI) in 2004. A major part of these were then demerged into a new company, Luvata, in 2006. Other large companies include Diehl (DE), Carlo Gnutti (IT) and Halcor (EL). About 30 companies in this sector have integrated foundries for the production of cakes, billets and other primary shapes for further processing. The others purchase these either from the smelters/refiners or from other semis manufacturers [238, ECI 2012].

Table 1.2 shows the copper production in the EU (and EAA) and Figure 1.2 and Figure 1.3 show the products.

Table 1.2: European production of copper and its alloys in 2011

Country	Production of copper, mine (kt)	Production of copper, smelter (kt)	Production of copper, refined (kt)
Austria	0	0	95
Belgium	0	0	402
Bulgaria	118	264	226
Cyprus	4	0	4
Finland	25	125	129
Germany	0	352	686
Italy	0	0	8
Norway	0	38	38
Poland	427	467	566
Portugal	74	0	0
Romania	6	0	0
Spain	98	295	407
Sweden	82	207	214
Total	835	1748	2774

Source: [363, Brown et al. 2013]

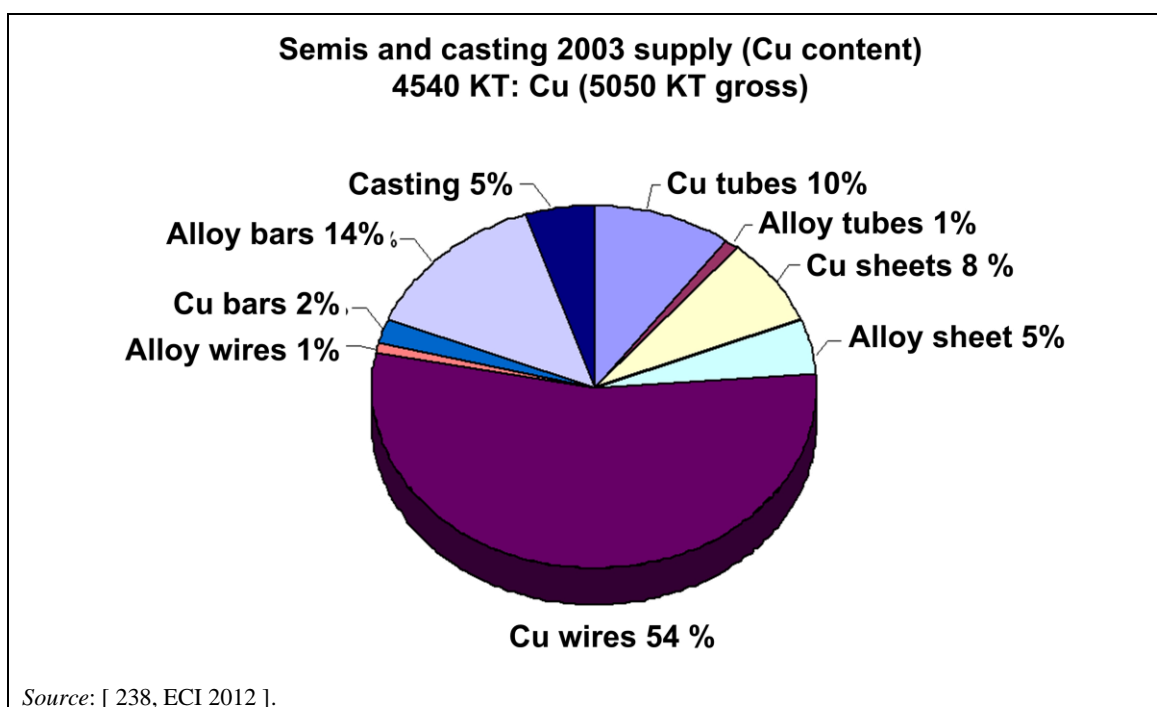

Figure 1.2: Copper semis products produced in 2003

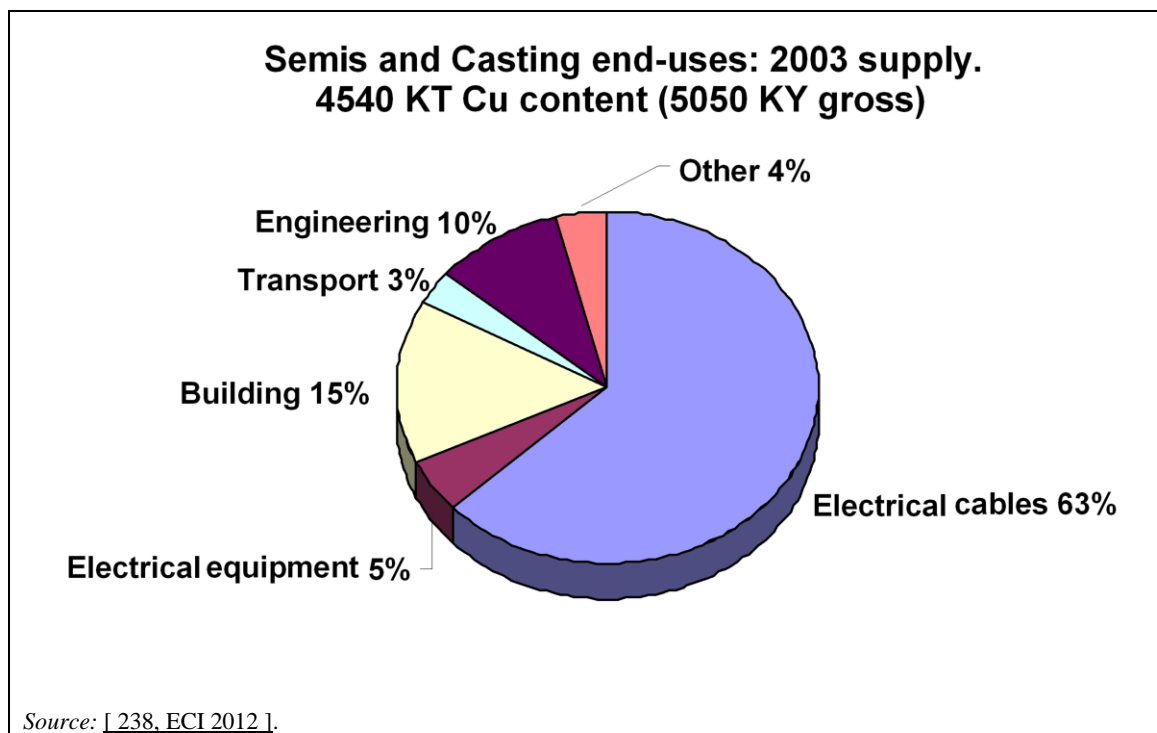

Figure 1.3: End uses for semis produced in the EU in 2003

1.2.4 Production sites

Annual refined copper production in the EU-28 reached 2.7 million tonnes in 2011, representing 13.6 % of worldwide production. The largest facilities are located in Germany, Poland, Spain, Sweden, Finland, Belgium and Bulgaria. The final refinery products, copper cathodes, are made through electrolytic processes. These are often melted and cast on the premises into 'refinery shapes', referred to as billets and cakes. Some copper refiners also produce wire rod, either at the refinery location or elsewhere [238, ECI 2012]

About 45 % of feed supplies to the EU-28 copper refineries are purchased on the international market in the form of copper concentrates, blister, anodes or scrap. The remaining 55 % come from EU-produced copper concentrates, copper-bearing residues and scrap.

European copper smelting and refining activity has been able to grow primarily by securing raw materials on the international market and by making use of 'domestic mining'. This consists of copper scrap and residues generated by consumers and processors, as well as by building demolition and end-of-life waste (e.g. vehicles and electric and electronic waste). Access to primary and secondary supplies has become increasingly difficult. This has partly been due to copper mining countries developing their own smelting and refining facilities, but mainly due to much stronger competition from countries such as China and India, seeking copper raw materials to meet the needs of their rapid industrialisation.

In 2007, there were 15 major copper refineries in the EU-27, employing around 10 000 people.

The major changes have been [238, ECI 2012]:

- the inclusion of KGHM Poland;
- the demerger of the Olen and Pirdop copper activities of Umicore (Union Minière) to the new company Cumerio;
- the merger of Hüttenwerke Kayser into Norddeutsche Affinerie AG;
- the merger of Norddeutsche Affinerie AG and Cumerio into Aurubis AG;
- the merger of Outokumpu Harjavalta and Pori into New Boliden AB;

- the merger of Krompachy into Montanwerke Brixlegg;
- the closure of the secondary copper smelters of IMI Refiners and MKM.

The resulting structure of the European copper smelting and refining industry is as follows:

- Atlantic Copper S.A. in Huelva, Spain;
- New Boliden AB with sites in Harjavalta and Pori, Finland and Rönnskär, Sweden;
- Aurubis AG with sites in Hamburg and Lünen, Germany; Pirdop, Bulgaria and Olen, Belgium;
- KGHM Polska Miedź S.A. with sites in Głogów (1 and 2) and Legnica, Poland;
- Metallo-Chimique in Beerse, Belgium with its daughter company Elmet S.L. in Berango, Spain;
- Montanwerke Brixlegg, Austria with its daughter company Krompachy, Slovakia;
- Umicore S.A. in Hoboken, Belgium.

Some of these are clear primary smelters (Atlantic Copper, KGHM, Pirdop and Harjavalta) which use copper concentrates as their primary feedstock. Others are clear secondary smelters (Metallo-Chimique, Montanwerke Brixlegg, and Aurubis Lünen), where the main feedstocks are scrap from the downstream value chain plus recycled products at the end of their life. Some have the flexibility to process both primary and secondary feedstocks, like Boliden Rönnskär, KGHM Legnica and Aurubis AG Hamburg.

New installations, facilities and technology innovations that have been developed since 2000 [238, ECI 2012] are:

- the KRS smelter for secondary copper materials in Lünen;
- the ISASMELT furnace in combination with a leaching and electrowinning plant in Hoboken;
- the house-in-house concept to capture diffuse emissions in Hamburg;
- chemical gypsum plants in primary smelting in a multistage process (Huelva and Pirdop);
- new fayalite slag tailings pond (Pirdop).

Two companies have capacities of around or over 500 000 tonnes of refined copper per year: KGHM, with three sites in Poland, Głogów I and II and Legnica; and Aurubis AG with sites in Hamburg and Lünen (Germany) and Olen (Belgium) and Pirdop (Bulgaria).

Two others have capacities of around 300 000 tonnes: Boliden in Rönnskär (Sweden) and Harjavalta/Pori (Finland), bought from Outokumpu in 2003, and Atlantic Copper in Huelva (Spain).

Montanwerke in Brixlegg (Austria) and Krompachy (Slovakia) produce around 100 000 tonnes and Metallo-Chimique at Beerse, in Belgium, and at Elmet in Berango, Spain, account for less than 50 000 tonnes (as cathodes but more than 100 000 tonnes as anodes).

Umicore (formerly Union Minière) in Hoboken (Belgium), OMG in Kokkola (FI) and Cyprus Copper, Cyprus also produce refined copper using a direct electrochemical route, with capacities of between 5000 tonnes and 50 000 tonnes.

There are some other, smaller facilities in the new Member States (e.g. Baia Mare, Romania) but no information was made available.

Not all companies have balanced capacities between smelting and electrolytic refining. Some ship a large part of their anodes (> 99 % copper) to refineries for final cathode (> 99.9 % copper) production.

Depending on the sources of scrap, EU versus imports, EU copper smelting and refining capacities can meet less than half of end-user demand. This structural shortage of EU-refined copper production is expected to continue, with the EU remaining a large net importer.

1.2.5 Key environmental issues

Historically, the major environmental problem associated with the production of copper from primary sources was the emission of sulphur dioxide to air from the roasting and smelting of sulphidic concentrates. This problem has been effectively solved by the EU smelters which now achieve on average a 98.9 % fixation of the sulphur and produce sulphuric acid and liquid sulphur dioxide.

The main environmental issues associated with the production of secondary copper are also related to the flue-gases from the various furnaces in use. There is also potential for the formation of PCDD/F due to the presence of small amounts of chlorine in the secondary raw materials, and the destruction of PCDD/F is an issue that is being pursued [219, VDI 2007].

Diffuse or uncaptured emissions are also becoming increasingly important for both primary and secondary production. Careful plant design and process operation is needed to capture process gases.

Recycled material constitutes an important component of the raw material supplies of the copper refining and manufacturing facilities. Copper can be recovered from the majority of its applications and returned to the production process without loss of quality in recycling. Having very limited access to domestic primary sources of copper, the EU industry has traditionally given much attention to so-called surface mines, relying, to a large extent, on scrap feed to reduce the large deficit of its copper raw materials trade balance.

Almost 100 % of new or process copper scrap is recycled and, according to some studies, it has been estimated that 95 % of old copper scrap that becomes available is also recycled.

Overall, secondary raw materials account for the production of about 40 % of EU copper, but in some cases, such as brass rods, the product is made entirely from recycled copper and brass, with only a small input of primary zinc.

The quality of secondary raw materials varies greatly and many sources of these materials are not suitable for direct use by the semis manufacturers. The scrap industry is relied upon to provide graded material of adequate cleanliness for the industry and, although there are agreed specifications for scrap, wide variations are encountered. Additional treatment or abatement systems may be needed.

The EU copper industry has developed advanced technologies and made considerable investments to be able to process a wide range of copper scrap, including complex, low-grade residues, and to comply at the same time with increasingly stringent environmental standards.

The ability of the industry to increase this high recycling rate depends on a number of complex factors.

1.3 Aluminium

1.3.1 General information

Aluminium [35, COM 1997] is a material with a large range of applications, notably in the transportation, construction and packaging industries, the electricity sector, in all high-voltage electricity distribution systems, household appliances, and in the mechanical and agricultural sectors. It is light, has good electrical conductivity and forms a surface oxide layer when exposed to air that prevents further corrosion. Aluminium is highly reactive, particularly in the form of powder, and is used in aluminothermic reactions to produce a variety of other metals.

The aluminium industry is the youngest and largest of the non-ferrous metals industries; aluminium smelting only began at the end of 19th century. The EU aluminium industry directly represents a workforce of about 255 000 people and its annual turnover was in the order of EUR 40 000 million in 2013.

1.3.2 Sources of materials

Primary aluminium is produced from bauxite that is converted into alumina; 100 tonnes of bauxite produces 40 to 50 tonnes of alumina (aluminium oxide), which can then produce 20 to 25 tonnes of aluminium. Most of the bauxite is mined outside Europe, but there are several alumina production facilities within Europe.

The secondary industry depends on the sources of scrap. Scrap can be termed 'new scrap' which is generated during the production and fabrication of wrought and cast products or 'old scrap' which is recovered from articles at the end of their useful life. The recycling rate of 'new scrap' is 100 % of the amount produced.

1.3.3 Production and use

The European aluminium industry includes mining and alumina production, primary and secondary smelting, and metal processing into semi-finished products (e.g. bars, profiles, wires, sheets, foils, tubes, pipes) and speciality products (e.g. powders, special alloys). Table 1.3 shows the various materials produced by the aluminium sector in the EU-27.

Table 1.3: Production of aluminium in the EU-27 in 2007 and 2012

Material produced	2007 (Mt)	2012 (Mt)
Metal production		
Bauxite mining	2.81	2.2
Alumina refining	6.9	5.8
Primary metal production	3.1	2.1
Secondary metal production (refining + remelting)	5.1	4.1
Semis		
Rolled	4.5	3.9
Extruded	3.2	2.5
Other	1	1.2
Total semis	8.7	7.6
Castings	33	2.9
<i>Source: [380, European Aluminium Association 2012]</i>		

In 2007, the EU-27 accounted for about 8 % of the total world production of primary aluminium but was a net importer of aluminium. Table 1.4 shows the production and consumption in world areas.

Table 1.4: Primary aluminium production and consumption by country in 2007 and 2012

	Production (kt)		Consumption (kt)	
	2007	2012	2007	2012
EU-27	3093	2070	7739	6486
Rest of Europe	2058	2111	528	469
US	2560	2070	5774	4869
Russia	3949	4028	1130	934
Canada	3083	2781	742	517
China	12 559	22 197	12 100	21 674
Australia	1963	1855	410	359
Brazil	1655	1436	854	1033
India	1223	1714	1150	1784
Middle East	1738	3709	NA	1143
Rest of the world	4154	3907	7642	8080
Total	41 128	47 878	45 808	47 348
NB: NA = Not available. Source: [380, European Aluminium Association 2012]				

Table 1.5 shows the sources of imported primary aluminium to the EU-27 as a percentage of the total imports.

Table 1.5: Imports of primary aluminium to the EU-27 in 2007 and 2012

	Imports to the EU-27 (% of total imports)	
	2007	2012
Asia	3	5
North America	5	4
Middle East	6	11
Latin America	9	1
Africa	16	15
Russia	17	12
Rest of Europe (without Russia)	44	52
Source: [380, European Aluminium Association 2012]		

The EU-27 production of aluminium from secondary raw materials in 2007 represents about one third of global secondary aluminium production.

1.3.4 Production sites

In 2007, a total of 25 primary aluminium smelters were operating in the EU-27 (18 in 2012), and a further 10 in the EEA. The number of companies is much smaller, and they consist of Rio Tinto Alcan (UK, France and Iceland), Alcoa Europe (Spain, Italy and Iceland), Hydro Aluminium (Norway and Germany), Zalco (the Netherlands), Trimet (Germany), Alro (Romania), Slovalco (Slovakia), Talum (Slovenia), Mytilineos (Greece), Rusal (Sweden) and Century (Iceland). Some of these companies have subsidiaries or branches in other parts of the world, or are part of international corporations.

The situation is different for the secondary aluminium sector, in which over 130 companies produce more than 1000 tonnes per year of secondary aluminium each. There is a good integration of the rolling activity with the production processes but the extrusion industry is much less integrated, with about 300 production sites scattered over the EU territory. Many production activities are integrated, but a number of EU manufacturers focus their activity on one particular segment only, such as recycling and secondary smelting or semis fabrication.

1.3.5 Key environmental issues

The main environmental issues for primary aluminium are the generation of polyfluorinated hydrocarbons and fluorides during electrolysis, the production of solid waste from the cells and the production of solid waste during the production of alumina. The generation of SO₂ from the sulphur content of the anodes is an issue in the Netherlands. The industry has made progress to reduce these emissions, in particular by adopting the Prebake technology for most of the smelters and upgrading the remaining Söderberg smelters in order improve their environmental and energy performances.

Regarding the production of secondary aluminium, there are potential emissions of dust and PCDD/F from poorly operated furnaces and poor combustion and the production of solid wastes (salt slag, spent furnace linings, dross and filter dust).

The main cost of producing primary aluminium is electricity, and as a consequence production has tended to concentrate where low-cost electricity is available, this being one of the prime determinants for the geographical distribution of the production sites. The European aluminium industry has made considerable efforts to reduce its electricity consumption, currently achieving an average use of 15 kWh per kg. The production and refining of secondary aluminium is much less demanding in terms of energy, accounting for a consumption per kg of about 5 % of the energy needed to produce primary aluminium.

There are many initiatives involved in improving the return of scrap aluminium and the industry is an active player in this area. The recycling of used beverage cans (UBCs) is an example of this. Collected material is recycled in a closed loop to produce more beverage cans to the same alloy specification. Much attention is paid by the secondary industry to producing the correct alloy composition and presorting of scrap types is important. An example of this is the segregation of extrusion scrap to preserve the particular alloy.

1.4 Lead and tin

1.4.1 Lead

1.4.1.1 General information

Lead [35, COM 1997], is an abundant metal in the earth's crust and has been used for many centuries. It is found in pure sulphide ores or in mixed ores where it is associated with zinc and small amounts of silver and copper. Lead is a soft metal; it has a low melting point and is resistant to corrosion. These properties give it great functional value, both in its pure form and as alloys or compounds.

Lead is classified in terms of the composition of the product. Table 1.6 shows the chemical composition of the grades of lead according to the European Standard.

Table 1.6: Chemical composition of the grades of lead according to the European Standard

Grade designation	Pb min.	1 Bi max.	2 Ag max.	3 Cu max.	4 Zn Max.	5 Ni max.	6 Cd max.	7 Sb max.	8 Sn max.	9 As max.	Total of 1 to 9 max.
PB 990R	99.990	0.010	0.0015	0.0005	0.0002	0.0002	0.0002	0.0005	0.0005	0.0005	0.010
PB 985R	99.985	0.015	0.0025	0.0010	0.0002	0.0005	0.0002	0.0005	0.0005	0.0005	0.015
PB 970R	99.970	0.030	0.0050	0.0030	0.0005	0.0010	0.0010	0.0010	0.0010	0.0010	0.030
PB 940R	99.940	0.060	0.0080	0.0050	0.0005	0.0020	0.0020	0.0010	0.0010	0.0010	0.060

NB: The German standard DIN 1719 is the basis for the European Standard EN 12659.

There have been major changes in the pattern of use of lead. The battery industry currently consumes around 85 % of the refined lead metal, and has been steadily increasing over the years. Other uses for lead, which include pigments and compounds, cable sheathing, shots and petroleum additives, have been in decline. The use of lead metal in rolled and extruded products such as lead sheets has been fairly stable over the years (see Table 1.7).

Table 1.7: Uses of lead worldwide

Commercial use	1973 (%)	1983 (%)	1993 (%)	2003 (%)	2011 (%)
Batteries	29	36	60	66	82
Lead sheet	8	6	5	5	6
Cable sheathing	7	4	3	1	0.9
Shot/Ammunition	2	2	2	2	1
Alloys	5	3	3	2	1
Pigments and other compounds	9	9	10	8	5
Gasoline additives	7	3	1	0.2	0.1
Other	2	2	4	3	2

Source: [377, ILA 2013]

1.4.1.2 Sources of materials

Refined lead is derived from primary material in the form of lead or mixed metal ores and concentrates, and secondary material in the form of scrap and residue. The balance between primary and secondary production has shifted since 1998, and in 2011 secondary sources accounted for more than 77 % of EU production. [377, ILA 2013]

Primary production requires the smelting of lead-bearing ores to produce lead bullion which is then refined. The economics of primary lead ore production are linked to the silver and zinc contents of the ore bodies. Since most ore bodies consist of compounds with sulphur (ore bodies containing lead carbonate also exist), lead metal production requires the sulphur content of the ores to be treated to produce sulphuric acid. Most primary lead smelters have a complex refining process associated with them and also processes to recover the silver content as a silver-gold alloy (where gold occurs, as many ore bodies are low in gold). Primary refining is therefore linked to the economics of mining lead-zinc ore bodies.

EU-27 countries produced 200 000 tonnes of lead concentrate in 2012 compared to 350 000 tonnes in 1996, the main producers being Ireland, Sweden and Poland. The main worldwide producers of lead ore are China, Australia, the US, Peru and Mexico. Total world mine production in 2012 was reported as 5.2 million tonnes. World refined lead metal production in 2012 was reported as 10.6 million tonnes. [377, ILA 2013]

The secondary refining industry now supplies the majority of lead consumed. Lead-acid batteries are the main source of scrap for secondary refining. The industry is making positive steps to encourage the recycling of these batteries; this proportion is increasing as the world car population increases and the return rate of old batteries increases. Secondary production also requires sulphur removal and other refining facilities as the secondary raw materials may contain unwanted compounds.

1.4.1.3 Production and use

In 2012, 1 770 000 tonnes of refined lead metal were produced in the EU-27, with approximately 77 % of this originating from secondary lead production. [377, ILA 2013]

Lead consumption is linked to the manufacture and use of lead-acid batteries and is estimated to account for 80–85 % of production. Other applications for lead include roofing materials and radiation protection. The use of lead in certain applications is limited by several EU regulations.

1.4.1.4 Production sites

There has been a major change in the processes used for lead production in the EU since 1998. All two-stage sintering/shaft furnace processes have now closed and all Imperial Smelting Furnaces have also closed except for one in Poland which is operated on a campaign basis to smelt sulphidic and then oxidic materials to recover lead and zinc. In 2008, there were only three direct smelting processes in use in the EU-27 with two in Germany and one in Italy. Lead production that is part of a complex metallurgical process to recover copper and precious metals remains unaffected.

Table 1.8 gives the annual capacities for lead processes in the EU-27 for 2006.

Table 1.8: Annual capacities for lead processes in the EU-27 in 2006

	Primary or combined primary and secondary smelting (t/yr)	Secondary smelting		Total lead
		Shaft furnace (t/yr)	Rotary or other furnace (t/yr)	Refining stage (t/yr)
Austria	0	0	32 000	32 000
Belgium	30 000	50 000	40 000	120 000
Bulgaria	70 000	30 000	0	100 000
Czech	0	35 000	0	35 000
France	0	0	120 000	120 000
Germany	210 000	50 000	100 000	360 000
Italy	100 000	0	160 000	260 000
Netherlands	0	0	20 000	20 000
Poland	35 000	0	55 000	90 000
Portugal	0	0	10 000	10 000
Romania	40 000	0	0	40 000
Spain	15 000	0	110 000	125 000
Sweden	65 000	45 000	0	110 000
UK ⁽¹⁾	180 000	0	85 000	265 000
Other	30 000	0	30 000	60 000
Total	775 000	210 000	762 000	1 747 000

⁽¹⁾ Includes non-EU bullion in primary smelting.

Production capacity has decreased by 500 000 t/yr since 1997 and the remaining direct smelters take in more and more secondary raw materials to increase their capacities to between 50 000 t/yr and greater than 100 000 t/yr.

The secondary lead industry is characterised by a large number of smaller installations, many of which are independent. There are approximately 30 secondary smelters/refiners in the EU producing from 5000 t/yr to 65 000 t/yr. They recycle and refine scrap generated in their local area. The number of these refineries is decreasing as the large multinational companies, and the major battery manufacturing groups as well, acquire the smaller secondary facilities or set up their own recycling operations. Figure 1.4 shows the European lead refining capacity in 2007.

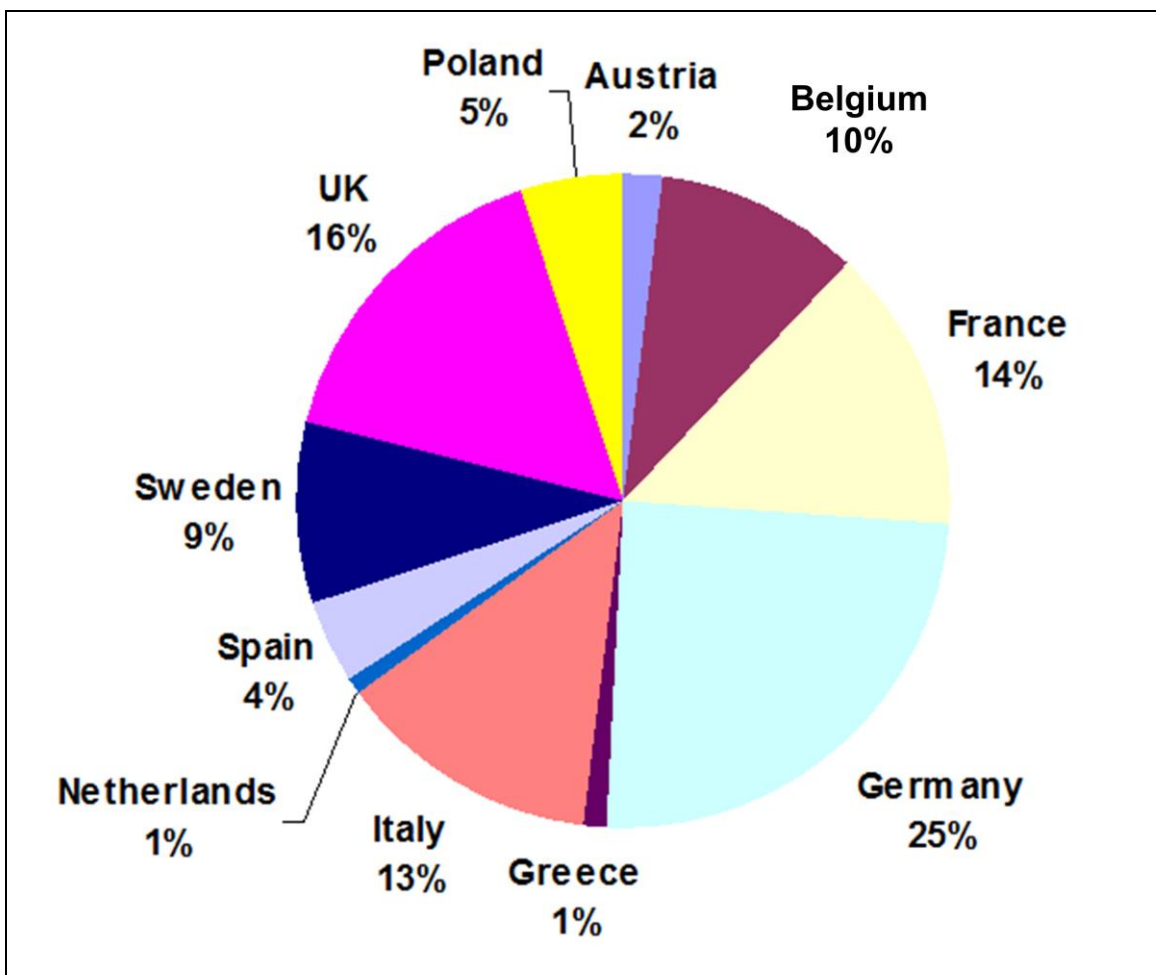

Figure 1.4: European lead refining capacity in 2007

The number of production sites has decreased and the total production capacity has fallen by 200 000 t/yr since 1998.

1.4.1.5 Key environmental issues

Historically, the major environmental problem associated with the production of lead from primary sources was the emission of sulphur dioxide to air from the roasting and smelting of sulphidic concentrates. This problem has been effectively solved by the EU smelters which now achieve a high fixation of the sulphur and produce sulphuric acid and/or liquid sulphur dioxide. Emissions of dust and metals from roads, storage areas and old waste deposits are also a potential problem. [254, VDI 2004].

The main environmental issues associated with the production of secondary lead are also related to the exhaust gases from the various furnaces in use. There is also the potential for the formation of PCDD/F due to the presence of small amounts of chlorine in the secondary raw materials and the destruction of PCDD/F is an issue that is being pursued [254, VDI 2004].

Lead is of great environmental concern and many lead compounds are classified as toxic. General policy is normally to restrict emissions to the lowest practicable levels given the state of technology, and recycling is normally conducted whenever appropriate and economic. Most control measures are concerned principally with human and animal exposure. Measures to protect children living in the vicinity of smelting plants are of particular significance. Environmental legislation requires investment to reduce lead in emissions to air. In recent years several new technologies have been developed and implemented which offer more efficient methods of smelting lead concentrates. These processes have also reduced emissions to the

environment. Existing processes have been improved using state-of-the-art control and abatement systems.

Batteries, which accounted for more than 80 % of the refined lead metal used in the EU-27 in 2012, are recycled with very high efficiency. The EU Battery Directive, 2006/66/EC, of September 2006 encourages high collection rates, prohibits disposal of lead batteries and prescribes from 2010 onwards a recovery rate of 65 % of the average weight of lead-acid batteries. Regulations for end-of-life vehicles (2000/53/EC) and electric and electronic goods (2002/96/EC) limit the use of lead in certain articles.

Regulations affecting lead fall into four main categories: occupational exposure, emissions (ambient air quality), controls on food and water, and product control. The limit values are complemented by rules on the protection of the workforce by providing the use of protective clothing, respirators, washing facilities or specifying rules on eating, drinking, smoking, etc.

Lead in the general atmosphere is limited by Directive 2008/50/EC on ambient air quality and cleaner air for Europe, which sets a limit for levels of lead in air throughout the EU. These limit values are being revised. Levels of lead in water are also controlled in a number of directives relating to water depending on its type and use, e.g. water intended for human consumption, water for bathing, fishing waters and on material in contact with food and drinking water. Specifically, lead is identified as a priority substance in Annex X to Directive 2000/60/EC establishing a framework for Community action in the field of water policy.

1.4.2 Tin

1.4.2.1 General information

Tin is one of the world's most ancient metals with references to its use dating back to 3500 BC. Of the different tin-bearing minerals found in the earth's crust, only cassiterite (SnO_2) is of importance. Cassiterite occurs both in deep hard rock mines and in shallow alluvial deposits and can be mined relatively easily, using industrial methods or basic and simple tools. Unlike many other metals, mining of cassiterite is carried out by artisanal and small mines, as well as by larger scale producers.

Tin is a soft, pliable metal easily adaptable to cold working by rolling, extrusion and spinning. It readily forms alloys with other metals, imparting hardness and strength. Because of its amphoteric nature, tin reacts with strong acids and strong bases but remains relatively resistant to neutral solutions.

The major uses for tin in 2011 were: solder, 52 %; tinfoil, 17 %; tin chemicals, 15 %; and other, 16 % [294, ITRI 2012]. In most cases, tin is used on or in a manufactured material in small amounts. Tin is used in various industrial applications in cast and wrought forms obtained by rolling, drawing, extrusion, atomising and casting; tinfoil, e.g. low-carbon steel sheets or strips rolled to 0.15–0.25 mm thick and thinly coated with pure tin; tin coatings and tin alloy coatings applied to fabricated articles (as opposed to sheets or strips) of steel, cast iron, copper, copper-base alloys, and aluminium; tin alloys; and tin compounds.

1.4.2.2 Sources of material

About 253 000 tonnes of tin were mined in 2011, mostly in China (110 000 t), Indonesia (51 000 t), Peru (34 600 t), Bolivia (20 700 t) and Brazil (12 000 t) [294, ITRI 2012]. Secondary or scrap tin is also an important source of the metal. The recovery of tin through secondary production, or recycling of scrap tin, is increasing rapidly.

Taking into account the reuse of recovered tin alloys, notably solders, brass and bronzes and lead alloys, secondary materials contribute to over 30 % of total tin use in any typical year. These alloys can be reused without the need for re-refining to pure tin. However, there has also been recent growth in secondary re-refined tin production which has exceeded 50 000 tonnes per year, equivalent to around 16–17 % of total refined metal production, and amounted to over 65 000 tonnes in 2011.

Alloy scrap containing tin is handled by secondary smelters as part of their production of primary metals and alloys; lead refineries accept solder, tin drosses, babbitt, and type metal. This type of scrap is remelted, impurities such as iron, copper, antimony and zinc are removed, and the scrap is returned to the market as binary or ternary alloy. The dross obtained by cleaning up the scrap metal is returned to the primary refining process.

1.4.2.3 Production and use

Spain and Portugal are the only EU-28 countries that produce mined tin, and even then only in minor quantities. Table 1.9 gives an overview of the quantity of tin extracted from mines worldwide.

Table 1.9: Annual world production of tin (mined) in 2006 and 2012

Country	Production of tin (tonnes of tin content in the ore)	
	2006	2012
Australia	2783	6158
Bolivia	17 669	19 700
Brazil	9528	10 800
Burma	900	700
Burundi	44	69
China	126 300	115 900
Democratic Republic of the Congo	5485	2462
Indonesia	80 933	91 000
Laos	600	965
Malaysia	2398	3726
Niger	13	0
Nigeria	1400	1800
Peru	38 470	26 105
Portugal	25	42
Russia	2600	600
Rwanda	3013	3500
Spain	0	69
Thailand	225	199
Vietnam	5400	5400
<i>Source: [363, Brown et al. 2013]</i>		

1.4.2.4 Production sites

Regarding smelter tin production, Belgium is the only EU-28 producer, with a world share of 3.5 %. Table 1.10 gives an overview of smelter tin production worldwide.

Table 1.10: Annual world production of tin (smelter) in 2006 and 2012

Country	Production of tin (tonnes)	
	2006	2012
Australia	572	0
Belgium	8000	11 400
Bolivia	14 089	14 300
Brazil	8780	9600
China	132 100	148 100
Indonesia	65 357	50 000
Japan	854	1133
Malaysia	22 850	37 822
Peru	40 495	24 811
Russia	3700	1400
Thailand	27 540	19 996
Vietnam	2665	4000

Source: [363, Brown et al. 2013]

1.4.2.5 Key environmental issues

The melting point of tin (232 °C) is low compared with those of the common structural metals, whereas the boiling point (2625 °C) exceeds that of most metals except tungsten and the platinum group. Loss by volatilisation during melting and alloying with other metals is insignificant. Tin oxide is insoluble and the ore strongly resists weathering so the amount of tin in soils and natural waters is low. The concentrations in soils are in the 1–4 ppm range but some soils have less than 0.1 ppm and others such as peat have 300 ppm [295, Gaver C. Jr 2013]. Tin as single atoms or molecules is not very toxic to organisms; the toxic form is the organic form. Organic tin compounds can stay in the environment for long periods of time. Organic tin can spread through water and can cause harm to aquatic ecosystems. They are very toxic to fungi, algae and phytoplankton.

1.5 Zinc and cadmium

1.5.1 Zinc

1.5.1.1 General information

Zinc [35, COM 1997], [117, Krüger, J. 1999] has the third highest usage of the non-ferrous metals, behind aluminium and copper. It has a relatively low melting point and is used in the production of a number of alloys such as brass. It can be easily applied to the surface of other metals such as steel (galvanising) and, when it is used as a metal coating, zinc corrodes preferentially as a sacrificial coating. Zinc is also used in the pharmaceutical, nutrient, construction, battery and chemical industries. See Table 1.11.

Table 1.11: World and European uses of zinc

Commercial use of zinc	Worldwide 1995 (%)	Worldwide 2000 (%)	Worldwide 2005 (%)	Europe 2005 (%)
Galvanising	47.9	48.6	51.4	44.4
Zinc alloying	12.9	15.7	16.4	14.5
Brass and bronze	20.7	19.3	17.0	20.4
Zinc semi-finished products	6.5	6.2	5.7	12.6
Chemicals	8.5	7.0	6.1	6.5
Zinc dust or powder	0.5	0.2	0.2	0.2
Miscellaneous	3.1	3.0	1.4	1.4
<i>Source: [229, IZA plant data 2008]</i>				

Zinc is supplied to the market in various qualities, the highest quality being special high-grade (SHG) or Z1 which contains 99.995 % zinc while the lowest quality good ordinary brand (GOB) or Z5 is about 98 % pure. The sector produces extrusion products such as bars, rods and wires (mainly brass); rolling products such as sheets and strips; casting alloys; and powders and chemical compounds, such as oxides (see Table 1.12 and Table 1.13).

Table 1.12: Primary zinc grades

Grade classification	Colour code	Nominal zinc content	1 Pb max.	2 Cd max.	3 Fe max.	4 Sn max.	5 Cu max.	6 Al max.	Total of 1 to 6 max.
Z1	White	99.995	0.003	0.003	0.002	0.001	0.001	0.001	0.005
Z2	Yellow	99.99	0.005	0.003	0.003	0.001	0.002	-	0.01
Z3	Green	99.95	0.03	0.005	0.02	0.001	0.002	-	0.05
Z4	Blue	99.5	0.45	0.005	0.05	-	-	-	0.5
Z5	Black	98.5	1.4	0.005	0.05	-	-	-	1.5
<i>Source: [1, CEN 2003]</i>									

Table 1.13: Secondary zinc grades

Grade	Nominal zinc content	1 Pb max.	2 Cd max.	3 Fe max.	4 Sn max.	5 Cu max.	6 Al max.	Total of 1 to 6 max.	Remarks
ZSA	98.5	1.3	0.02	0.05	- ⁽¹⁾	-	0.05	1.5	Obtained mainly by zinc-bearing process scrap (e.g. Zn ashes)
ZS1	98.0	1.3	0.04	0.05	0.7 ⁽¹⁾	-	0.1	2.0 ⁽²⁾ 1.5	Obtained mainly by recycling of scrap
ZS2	97.5	1.5	0.05	0.12	0.7 ⁽¹⁾	-	-	2.5 ⁽²⁾ 2.0	Also used products

⁽¹⁾ Sn max. 0.3 % for brass making.
⁽²⁾ For galvanising applications, EN ISO 1461: zinc bath must contain less than 1.5 % alloying elements (excluding Fe & Sn) and 2.0 % (including Fe & Sn).
Source: [1, CEN 2003.]

End uses include a wide range of applications, the most important being steel protection against rust for the automobile, appliance and building industries. Zinc alloys (e.g. brass, bronze, die-casting alloys) and zinc semis are respectively the second and third major consumption areas with applications also in the building, appliance and car industries.

1.5.1.2 Sources of materials

Metal is produced from a range of zinc concentrates by pyrometallurgical or hydrometallurgical processes. Some concentrates contain high proportions of lead and these metals are also recovered. Zinc is also associated with cadmium and the concentrates are a source of this metal.

EU concentrates used to meet more than 45 % of the EU refinery demand towards the end of the 1980s. This fell to 25 % over the next decade. After the accession of 12 new Member States (2004), EU concentrates accounted for 38 % of the demand. The deficit is filled by increased imports, as mine production capacity is increasing in North America, Australia and some South American countries.

Secondary raw materials such as galvanising residues (ashes, skimmings, sludges, etc.), and recycled products (e.g. Waelz oxide) from zinc-containing residues (e.g. flue-dust from steel plants) are used. Brass processing and die-casting scrap, and end-of-life roofing products are also sources of zinc. Metal production from secondary sources accounted for more than 8 % of the total EU refined zinc output in 1994. The recycling of zinc and zinc products is a key issue for the industry.

1.5.1.3 Production and use

The EU mine output is essentially accounted for by Ireland, Sweden and Poland and was 818 000 tonnes of zinc concentrates in 2007. This increase from 400 000 tonnes in 1998 is a result of process optimisation, opening of new mining operations and the accession of Poland. Metal production stepped back below the 1.8 million tonnes mark which it had overstepped in 1992, while consumption of refined zinc increased from 1 640 000 tonnes to 1 770 000 tonnes, accounting for 30 % of the demand for zinc in the market economy countries. See Table 1.14, Table 1.15 and Figure 1.5.

Table 1.14: World production of zinc concentrates in 2007

	Production in 1995 (kt)	Production in 2000 (kt)	Production in 2005 (kt)	Production in 2007 (kt)
India	NA	NA	NA	745
Canada	1121	1002	667	619
Australia	882	1380	1329	1402
Peru	692	910	1202	1444
US	644	852	748	787
EU	555	676	841	818

NB: NA = Not available.
Source: [229, IZA plant data 2008]

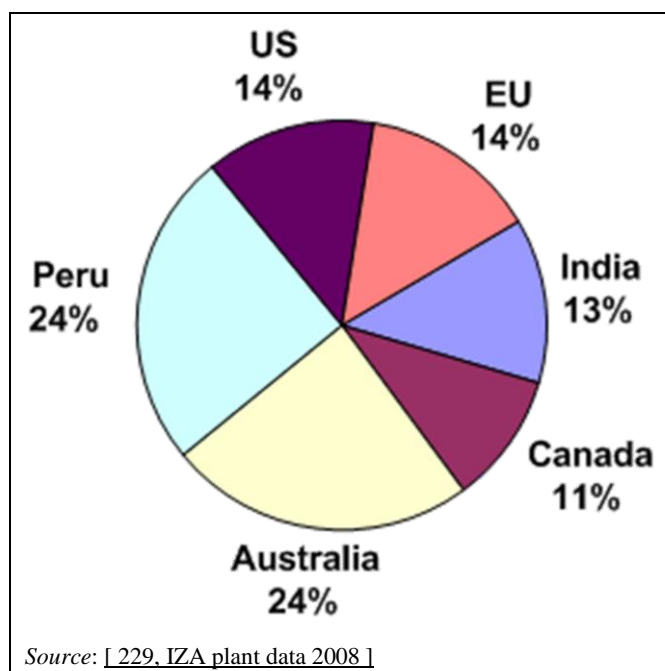
**Figure 1.5: World production of zinc from concentrates in 2007 excluding China**

After China, the EU stands as the second in the world for zinc production, far ahead of Canada and Japan, which rank third and fourth, respectively. In 2007, EU output was recorded at 2 160 000 tonnes of primary metal production, accounting for nearly 20 % of the market economy total of 11 million tonnes. Also after China, the EU is the major consumer area for zinc among the market economy countries. The 2 500 000 tonnes of zinc consumed in 2007 was 30 % below the reported Chinese market and more than double the third largest consumer market, the US.

Table 1.15: World production of refined zinc

	Production in 1995 (kt)	Production in 2000 (kt)	Production in 2005 (kt)	Production in 2007 (kt)
China	NA	NA	NA	3700
EU	1999	2016	2034	2160
Canada	720	780	724	802
India	NA	NA	NA	745
Japan	664	654	638	598
US	363	371	350	266
Australia	322	494	457	502
CIS	410	538	608	668

NB: NA = Not available.
Source: [229, IZA plant data 2008]

1.5.1.4 Production sites

Primary zinc is essentially produced by roast-leach-electrowin (RLE) processes and by the Imperial Smelting Furnace (ISF) distillation process. Table 1.16 shows the location and capacities of the sites in Europe.

Table 1.16: Production of zinc in Europe from primary raw materials in 2007

Country	Company	Location	Process	Capacity (t/yr)
Belgium	Nyrstar	Balen-Overpelt	RLE	260 000
Bulgaria	KCM OCK	Plovdiv	RLE	75 000
		Kardjali	RLE	45 000
Finland	Boliden	Kokkola	RLE	305 000
France	Nyrstar	Auby	RLE	130 000
Germany	Ruhr-Zink ⁽¹⁾ Xstrata	Datteln	RLE	150 000
		Nordenham	RLE	140 000
Italy	Glencore	Portovesme (Sardinia)	RLE	100 000
Netherlands	Nyrstar	Budel-Dorplein	RLE	240 000
Norway	Boliden	Odda	RLE	165 000
Poland	ZGH Bolesław HC Miasteczko Slaskie	Bolesław	RLE	90 000
		Miasteczko	ISF	80 000
Romania	Mytilineos	Copsa Mica	ISF	45 000
Spain	Xstrata Española del Zinc	San Juan de Nieva	RLE	490 000
		Cartagena	RLE	NA

⁽¹⁾ Ruhr-Zink ceased operation on 31.12.2008.
NB:
RLE: Roast-leach-electrowin.
ISF: Imperial Smelting Furnace.
NA = Not available.
Source: [229, IZA plant data 2008]

Zinc is recycled from end-of-life products such as sheets, brass and die-casting parts which are remelted and reused. It is also recycled from the remelting of scrap steel in electric arc furnaces (EAF) where the zinc is fumed and captured with the flue-dust and recovered in specialised facilities.

Table 1.17 shows the location and capacities of the sites in Europe.

Table 1.17: Recycling units for zinc from end-of-life products in the EU (2007)

Country	Company	Location	Process	Average production as Zn (kt/yr)
Bulgaria	KCM	Plovdiv	Waelz	20
France	Arcelor-Mittal	Isbergues	MHF ⁽¹⁾	20
	Recytech	Fouquières	Waelz	25
Germany	Befesa	Duisburg	Waelz	20
	Befesa	Freiberg	Waelz	45
	Recylex	Gosslar	Waelz	15
Italy	Pontenossa, SpA	Pontenossa	Waelz	20
	Glencore	Portovesme	Waelz	20
Luxemburg	Arcelor-Mittal	Waiver	MHF ⁽¹⁾	25
Norway	Eras Metal	Hoyanger	Plasma	15
Poland	Bolesław recycling	Bolesław	Waelz	25
Spain	Befesa	Bilbao	Waelz	35

⁽¹⁾ MHF: Multiple hearth furnace.
Source: [229, IZA plant data 2008]

1.5.1.5 Key environmental issues

Historically, the major environmental problem associated with the production of zinc from primary sources was the emission of sulphur dioxide to air from the roasting and smelting of sulphidic concentrates. This problem has been effectively solved by the EU smelters which now achieve a high fixation of the sulphur and produce sulphuric acid and liquid sulphur dioxide.

The leaching of calcine and other material produces liquor that contains iron. The removal of iron results in the production of significant quantities of solid waste that contain a variety of metals. The disposal of this waste requires a very high standard of containment and monitoring.

Diffuse emissions from roasting and calcining are also very important and need to be considered for all of the process stages. The diffuse emissions of acid mists from the electrowinning of zinc are a particular example of this.

Zinc and zinc products can be largely recycled. Estimates based on historical consumption and product life cycles indicate that a recovery rate of 80 % of recoverable zinc has been reached. The recycling system for zinc is far advanced, not only for zinc metal but also for several different forms.

1.5.2 Cadmium

1.5.2.1 General information

Cadmium belongs to the zinc subgroup of the periodic table and was discovered by Friedrich Strohmeyer in 1817 during an investigation into $ZnCO_3$. It is associated with zinc in minerals at a ratio of 1:300 Cd to Zn. It is physically similar to zinc but is softer and denser and can be polished. Unlike zinc, it is resistant to alkalis. Cadmium is also a good absorber of neutrons and is therefore often used in nuclear reactors. In its compounds it has an oxidation state of 2+. Cadmium is distributed worldwide with a content between 0.1 ppm and 1 ppm in the topsoil.

1.5.2.2 Source of materials

There are only a few cadmium-specific minerals, such as greenockite (CdS) or otavite ($CdCO_3$) and CdO . None of these minerals are industrially important. Zinc minerals which contain cadmium as an isomorphic component at concentrations of about 0.2 % have economic significance for cadmium recovery. In addition, lead and copper ores may contain small amounts of cadmium.

1.5.2.3 Production and use

Unlike other metals, cadmium has been refined and utilised only relatively recently; production and use have arisen only during the last 50 to 60 years. The main uses today are:

- electroplated cadmium coatings;
- nickel-cadmium batteries;
- some pigments and stabilisers for plastics;
- alloys for specialised thermal and electrical conductivity applications, electrical contact alloys and nuclear control rods;
- small amounts are used for solar cells.

Since 1988, global cadmium production has decreased fairly constantly from 20 000 t/yr to 18 000 t/yr. The use of cadmium in various applications has varied since 1970 and has been affected by technical, economic and environmental factors. This has influenced the metal prices. Metal prices in the 1970s reached USD 3 per lb, and in the 1980s varied between USD 1.1 and USD 6.9 per lb. Since that time the cadmium price has fallen to USD 1 per lb and even went as low as USD 0.45 per lb, which is equivalent to the zinc price level.

The main cadmium producer and user countries are shown in Table 1.18.

Table 1.18: Main cadmium producers and users in 2007

Country	Production (t/yr) (Cd and Cd compounds)	Use (t/yr) (Cd and Cd compounds)
Korea	3704	100
China	3000	5407
Canada	1388	107
Japan	1934	2210
Belgium	0	4799 (as CdO)
Mexico	1584	140
United States	700	441
Germany	575	666
France	300	268

Cadmium is recovered:

- from pyrometallurgical Pb-Cu recovery from the flue-dust from the smelting operation;
- from pyrometallurgical Pb-Zn recovery from the flue-dust from the sinter/roast operation and from crude zinc;
- from hydrometallurgical extraction from zinc in the cadmium cementate produced in electrolyte purification.

Flue-dusts are generally leached with H_2SO_4 to separate the cadmium which is afterwards precipitated as $CdCO_3$ or reduced to cadmium sponge with more than 90 % cadmium. The sponge may be either smelted under NaOH and vacuum distilled, or dissolved and electrolysed.

Crude zinc may be distilled in New Jersey columns to produce pure zinc and a Cd-Zn alloy with more than 60 % cadmium. The Cd-Zn alloy from the New Jersey distillation operation is distilled twice before pure cadmium is produced.

Cements are usually dissolved and electrolysed to produce cadmium of a high purity (≥ 99.99 % cadmium).

1.5.2.4 Production sites

In the 1990s, several EU operations ceased activity. Cadmium is still extracted from the main zinc processes under controlled conditions and the residue is safely deposited according to the waste legislation. Recycling takes place, but very few companies take part. Mainly, used batteries are recycled to recover cadmium and nickel (see Table 1.19).

Table 1.19: Main European primary and secondary cadmium producers in 2007

Country	Company	Location	Process	Capacity (t/yr)
Bulgaria	KCM OCK	Plovdiv Kardjali	RLE	320 100
France	SNAM	Viviez	Recycling	300
Germany	Xstrata Accurec	Nordenham Mülheim	RLE Recycling	475 100
Italy	Glencore	Portovesme	RLE	450
Netherlands	Nyrstar	Budel	RLE	575
Norway	Boliden	Odda	RLE	100
Poland	H.C. Miasteczko Sl.	Miasteczko Słą	ISF	350
Sweden	SAFT	Oskarshamn	Recycling	300
Romania	Mytilneos	Copsa Mica	ISF	100

1.5.2.5 Key environmental issues

The status of legislation of cadmium compounds has a significant impact on emissions. The level of cadmium in the atmosphere is limited by Directive 2004/107/EC relating to arsenic, cadmium, mercury, nickel and polycyclic aromatic hydrocarbons in ambient air. Cadmium is also identified as a priority hazardous substance in Annex X to Directive 2000/60/EC establishing a framework for Community action in the field of water policy.

A typical zinc production process can produce 600 t/yr of cadmium. Cadmium production is closely controlled to prevent diffuse emissions and remove dust to a very high standard. Less than 2 % of the exposure of the general population to cadmium is due to emissions to the environment from cadmium-bearing products in their total life cycle.

In many applications, cadmium alloys are essential and cannot be substituted with other materials. Similarly the use of cadmium in rechargeable batteries can also be an environmental benefit.

The critical effect of cadmium in human beings is renal tubular dysfunction. The tubular damage is irreversible at advanced stages, so prevention is more important than diagnosis. The long biological half-life of cadmium can lead to a continuous increase in renal levels over many years and so past exposure is often more important than present exposure. In that perspective, most of the EU operations apply risk prevention and risk management measures contained in the EMI/CdA guidance document updated in 2006.

1.6 Precious metals

1.6.1 General information

Precious metals [35, COM 1997] include such well-known metals as gold and silver as well as the six platinum group metals (PGMs): platinum, palladium, rhodium, iridium, ruthenium and osmium. They are termed precious metals because of their rarity and intrinsic value.

The EU has the largest refining and fabricating capacity for precious metals in the world, even though its actual mineral resources of such metals are limited. The recycling of precious metals from scrap and industrial residues has always been an important raw material source for the EU precious metals industry.

Consumption of gold in the EU is mainly for jewellery, with smaller amounts used in electronics and other industrial and decorative applications. The principal users of silver are industrial applications (47 %), with the photographic and jewellery industries accounting for 6 % and 15 % respectively. The platinum group metals are used extensively as catalysts and the imposition of emission limits on vehicles sold in the EU has stimulated demand for their use in catalytic converters.

1.6.2 Sources of materials

Mines in all parts of the world consign large quantities of precious metals, in crude ore or by-product forms, to EU refineries. Refineries with significant precious metal capacities are found in Belgium, Germany, Sweden, Finland and the United Kingdom. Bulgaria, Poland and Romania have considerable mining activities either in precious metals or base metals with precious metal content. These activities typically recover precious metals from lead and zinc, copper or nickel ores, as well as low-grade scrap materials of all kinds, and they supply the pure metals in bars or plates, grain or sponge.

There are small deposits of precious metal ores in Europe; Table 1.20 shows the mine production in 2005 and 2012. Poland is the world's second largest producer of silver after Mexico. These resources account for approximately 25 % of the world's primary silver, 1.1 % of the world's primary gold and 0.08 % of the world's primary PGMs. Deposits of gold are being developed in Greece and their contribution will be significant in years to come.

Table 1.20: Precious metal mine production in 2005 and 2012

Country	Silver (t) 2005	Silver (t) 2012	Gold (t) 2005	Gold (t) 2012	PGMs (t) 2005	PGMs (t) 2012
Finland	15.0	128.2	0.5	10.8	0.1	0
France	1.0	NR	3.5	NR	NR	NR
Greece	25	31	NR	NR	NR	NR
Ireland	4.0	9.4	NR	NR	NR	NR
Italy	5.0	0	NR	NR	NR	NR
Poland	1244	1149	0.71	0.92	0.07	0.05
Portugal	24	29.9	NR	NR	NR	NR
Romania	20	18	0.5	0.5	0.01	NR
Spain	5.0	32.6	5.4	1.3	NR	NR
Sweden	268	309.3	6.3	6.0	NR	NR

NB: NR = Not reported.
Source: [363, Brown et al. 2013]

Europe has a number of companies that specialise in the collection, preprocessing and trading of scrap and secondary materials before the actual assay and refining stages take place. Typical items are discarded catalysts, printed circuit boards, obsolete computers, old photographic film, X-ray plates and solutions, spent electroplating baths, etc.

1.6.3 Production and use

The cost of recovery and recycling is more than justified by the high intrinsic value of the precious metals contained in these scrap and residues. It is not just the economic aspects that encourage the recycling of precious metals but also the environmental issues where stricter limits on the tolerable metal content of waste materials sent for dumping are being set.

The refining of gold, silver and the platinum group metals in the EU takes place either at specialist precious metal refining and fabricating companies or at base metal refineries. The total precious metal refining capacity of the EU firms is the largest in the world (see Table 1.21).

Table 1.21: Annual capacities of European refineries in 2006

Country	Silver (t/yr)	Gold (t/yr)	PGMs (t/yr)
Austria	190	70	1
Belgium	2440	60	45
France	1520	135	12
Germany	2700	193	92
Italy	1050	115	15
Netherlands	130	15	1
Poland	1500	3	0
Spain	830	30	5
Sweden	250	15	1
UK	2320	300	100
Switzerland	620	565	14
Other EU countries	50	10	5

The refinery capacity is approximately double the amount actually processed so a rapid turnaround of processed metal can be maintained.

Most of the precious metals are fairly easily fabricated either as pure metals or as alloys. Gold and silver in particular are usually turned into specific alloys for jewellery or dental purposes in order to improve wear resistance or colour. Because of the high intrinsic value and the wide range of forms and alloys required, such metals are usually fabricated or processed in relatively small quantities compared with base metals. One of the few precious metal products manufactured in tonnage quantities is silver nitrate for the photographic industry.

European demand for precious metals is high. The jewellery trade has the highest consumption of gold, and the industrial applications of silver. The highest consumption of platinum is in the production of auto catalysts. Other principal uses are in chemicals, dentistry and investment such as coinage. The demand in 2006 for precious metals is shown in Table 1.22 below.

Table 1.22: Precious metal demand in 2006

Total demand	Silver (t/yr)	Gold (t/yr)	PGMs (t/yr)
European	5710	881	85
World	26142	3692	488

1.6.4 Production sites

The principal precious metals refiners and fabricators of the EU operate on an international scale and are world leaders in their field. Prominent names are Umicore and Heraeus in Germany and Johnson Matthey and Vale in the United Kingdom. The US precious metals firm, Engelhard Corporation, operated in the EU for a number of years. The catalyst manufacturing and refining sites of Engelhard were acquired by BASF in 2008.

Major EU base metal refiners with significant precious metal involvement include Umicore in Belgium, Aurubis in Germany, Norilsk Nickel in Finland, KGHM Polska Miedź in Poland and New Boliden in Sweden.

1.6.5 Environmental issues

The EU precious metal refineries form a technically advanced, high-performance industry that is very strongly focused on research and development. The processes often use hazardous reagents such as HCl, HNO₃, Cl₂ and organic solvents. Advanced processing techniques are used to contain these materials and the small scale of production allows these techniques to be used effectively to minimise and abate potential emissions. This encompasses not merely new uses for the precious metals but also the discovery of techniques for economising the quantities of precious metals used in existing applications. The raw materials are subject to intensive sampling and assay and any process wastes are analysed to the same standard.

The recovery of these metals from secondary raw materials is particularly important and many of these materials are classified as wastes by other industries.

1.7 Ferro-alloys

1.7.1 General information

Ferro-alloys are master alloys that contain some iron and one or more non-ferrous metals as alloying elements. Silicon metal is produced in the same metallurgical process as ferro-silicon and is therefore considered a ferro-alloy. Ferro-alloys are used as deoxidising elements in steelmaking and enable alloying elements such as chromium, silicon, manganese, nickel, vanadium and molybdenum to be safely and economically introduced into metallurgical processes, thus giving certain desirable properties to the alloyed metal, for instance increased corrosion resistance, hardness or wear resistance.

The importance of ferro-alloys increased with the progress of steel metallurgy, which demanded diversified alloying elements to achieve better controlled quantities in purer and more advanced steel qualities. The ferro-alloy industry became a key supplier to the steel industry.

Silicon metal is used as an alloying element in aluminium and in the chemical and electronic industries, solar cells, etc.

Ferro-alloys are usually classified in two groups:

- bulk ferro-alloys (ferro-chrome, ferro-silicon together with silicon metal, ferro-manganese, silico-manganese and ferro-nickel), which are produced in large quantities in electric arc furnaces;
- special ferro-alloys (ferro-titanium, ferro-vanadium, ferro-tungsten, ferro-niobium, ferro-molybdenum, ferro-boron, alloyed or refined ferro-silicon, silicon metal and ternary/quaternary alloys) which are produced in smaller quantities, but with growing importance.

Bulk ferro-alloys are used mainly in steelmaking and steel or iron foundries. The uses of special ferro-alloys are far more varied, and the proportion used in steelmaking has diminished over recent years in favour of those used in the aluminium and chemical industries, especially silicon products.

1.7.2 Sources of materials

The raw materials (alloying elements) for the production of ferro-alloys are either the main products (quartzite for silicon, chromite for chrome, matte for nickel, etc.) or the by-products of mining (molybdenite from copper mining). Of course, the two sources can exist simultaneously. In most cases for FeCr and FeMn production, the iron part is also received from ore and no iron is added.

The raw materials can also be recovered from scrap, which is most often the case for the iron share of the composition, which comes from iron and steel scrap, but also for the alloying element itself, titanium for example. Residues from steel mills like electric arc furnace and converter filter dust, as well as shot blasting and grinding dust, are important secondary raw materials which have increasing significance. The main raw material sources and mineral deposits for the alloying elements are given below.

- Chromite is mostly concentrated in two large deposits, which are located in South Africa and Kazakhstan. Smaller deposits are found in other places such as India, Brazil and Europe (Finland, Turkey, Albania and Greece).
- Raw material for producing ferro-silicon and silicon metal is available everywhere in the world, although not all sources allow the production, under acceptable economic and quality conditions, of all the ranges of silicon alloys.

- Ore that contains manganese is mainly found in South Africa, Ukraine, Gabon and Australia. Smaller occurrences are found in Brazil, India, Mexico and Myanmar. The quality (content of manganese and level/nature of the impurities) of the ore can greatly influence the economics of the ferro-alloy production.
- Ore that contains nickel is mainly found in Australia, New Caledonia, Indonesia, the Philippines, China, Brazil, Colombia, Canada, Kazakhstan, Russia and Africa. The concentration of nickel in the ore has a significant bearing on the type of metallurgical process used, which in turn influences the economics of production.
- The special alloying elements are very often concentrated in a few countries (molybdenum in North America, Chile and China; niobium in Brazil) and prices and availability are very sensitive to economic conditions.
- Rich slags are also a significant raw material and come from FeMn processes and battery recovery.

1.7.3 Production and use

Since around 1978, the ferro-alloy market has changed significantly worldwide. Consumption in developing countries has vastly increased with the development of their steel production industries, and they have now taken over an increasing share of the traditional markets of the industrialised countries, where steel production was stagnant or growing at a slow rate. The EU ferro-alloy industry is hence facing a growing proportion of imports, at first from the new industrialised countries and in recent years from the countries of eastern Europe, the CIS and China.

As a consequence, EU ferro-alloy production has been subject to challenging competition that has resulted in a decreasing trend of the total amount of ferro-alloys produced in the EU. The actual total European production of bulk ferro-alloys split into the different alloys and the countries where they are being produced can be seen in Table 1.23. While global production of ferro-alloys increased between 2003 and 2007 from 22.6 million tonnes to 31.8 million tonnes (see Table 1.24) European ferro-alloy production decreased from 3 billion tonnes to 2.1 million tonnes. The leading ferro-alloy producing countries in 2007 were, in descending order of production, China, South Africa, Ukraine, Russia and Kazakhstan. These countries account for 78 % of world ferro-alloy production.

The last European blast furnace used for bulk ferro-alloys production was closed in 2003 and now all bulk ferro-alloys in Europe are produced in electric arc furnaces.

Table 1.23: European production of bulk ferro-alloys from 2006 to 2012 in tonnes per year

Country	Sub-commodity	2005	2006	2007	2008	2009	2010	2011	2012
Austria	Ferro-molybdenum	5000	5000	5000	4500	4000	4000	4000	4000
	Ferro-nickel ⁽¹⁾	2500	2500	3000	2000	2500	2500	2500	2500
	Ferro-vanadium	6250	6250	6500	6300	6200	8000	8000	8000
Bulgaria	Ferro-silicon	10 000	10 000	10 000	6000	3000	0	0	0
Czech Republic	Ferro-vanadium	2600	2800	1700	2800	1900	3400	4600	5700
Finland	Ferro-chrome	234 881	243 350	241 760	233 550	123 310	238 000	231 000	229 000
France	Ferro-manganese	NA	NA	144 000	46 600	46 000	138 100	130 500	131 000
	Ferro-manganese & spiegeleisen	109 111	139 533	0	0	0	0	0	0
	Ferro-silico-manganese	52 300	63 300	65 400	60 200	54 100	62 400	63 400	64 000
	Ferro-silicon	67 000	34 000	31 000	30 000	18 300	27 000	59 000	60 000
	Silicon metal	100 000	100 000	120 000	118 000	80 000	112 000	128 000	130 000
Germany	Ferro-chrome	22 672	26 710	22 030	26 960	13 667	17 300	17 800	17 800
	Other ferro-alloys	25 400	24 100	5000	5000	6336	9200	9000	9000
	Silicon metal	29 349	29 865	29 379	29 092	27 620	30 105	30 134	28 574
Greece	Ferro-nickel	96 000	89 000	93 300	83 200	42 400	69 600	94 000	96 435
Iceland	Ferro-silicon	114 844	113 798	114 886	107 882	112 992	114 230	120 076	131 818
Italy	Ferro-manganese	32 000	30 000	30 000	30 000	20 000	25 000	25 000	27 000
	Ferro-silico-manganese	99 000	96 600	87 000	87 000	56 000	108 000	14 5000	110 000
Norway	Ferro-manganese	130 000	130 000	130 000	130 000	130 000	130 000	130 000	130 000
	Ferro-silico-manganese	288 137	325 708	293 699	273 485	247 615	281 266	248 700	266 000
	Ferro-silicon	329 316	123 819	170 024	185 344	233 974	200 000	170 102	203 886
	Other ferro-alloys	60 000	60 000	62 000	60 000	150 000	150 000	150 000	150 000
	Silicon metal	178 572	150 000	140 000	180 135	169 643	170 000	170 000	170 000
Poland	Ferro-manganese	7782	4089	2093	8475	1736	800	800	800
	Ferro-silico-manganese	10 242	3310	15 590	2 5061	72	100	400	200
	Ferro-silicon	65 118	13 034	58 538	56 031	9673	53 206	72 668	79 400
	Other ferro-alloys	3663	4488	6255	2948	4190	200	300	300
Romania	Ferro-chrome	0	0	0	6179	15 377	14 353	0	0
	Ferro-manganese	18 625	3777	0	0	0	0	0	0
	Ferro-silico-manganese	100 957	66 476	26 868	9979	0	20 605	30 000	30 000
Slovakia	Ferro-chrome	867	19	0	0	0	0	0	0
	Ferro-silico-manganese	47 843	59 128	71 587	59 940	32 000	34 960	25 036	50 089
	Ferro-silicon	16 512	16 155	8583	10 844	4600	26 419	32 304	32 726
	Other ferro-alloys	48 161	65 498	74 065	61 194	22 250	38 860	18 575	12 862
Slovenia	Ferro-silicon	15 529	12 550	6000	0	0	0	0	0
Spain	Ferro-manganese	35 000	148 000	155 000	161 000	60 100	134 000	108 000	108 000
	Ferro-silico-manganese	100 000	100 000	153 000	158 000	59 200	132 000	164 000	165 000
	Ferro-silicon	70 000	67 000	71 000	74 000	44 000	64 400	57 000	57 000
	Silicon metal	32 000	32 000	32 000	33 000	23 000	32 500	43 000	45 000
Sweden	Ferro-chrome	127 500	136 400	124 400	118 700	31 100	64 400	80 140	35 800
	Ferro-silicon	9800	4600	4300	0	0	0	0	0

NB: NA = Not available.

⁽¹⁾ Austria stopped producing ferro-nickel in 2013.

Source: [363, Brown et al. 2013]

Table 1.24: Global ferro-alloy production by furnace type and alloy type from 2003 to 2007 in tonnes per year (gross weight)

Furnace type	Alloy type	2003	2004	2005	2006	2007
Blast furnace	Ferro-manganese	899 000	826 000	648 000	764 000	774 000
	Spiegeleisen	12 000	12 000	12 000	12 000	12 000
	Other	104 000	104 000	63 500	63 500	83 500
Electric furnace	Ferro-chrome	6 070 000	6 590 000	6 910 000	7 340 000	8 370 000
	Ferro-chrome silicon	123 000	131 000	128 000	129 000	133 000
	Ferro-manganese	3 130 000	3 840 000	3 770 000	4 190 000	4 420 000
	Ferro-nickel	983 000	1 050 000	1 080 000	1 140 000	1 170 000
	Ferro-niobium (ferrocolumbium)	37 000	26 200	39 900	42 600	43 100
	Ferro-silicon	4 950 000	5 660 000	5 800 000	6 480 000	6 760 000
	Silico-manganese	4 620 000	6 020 000	6 080 000	6 930 000	7 310 000
	Silicon metal	703 000	760 000	811 000	628 000	641 000
	Other 27	1 000 000	1 360 000	2 330 000	410 000	463 000

Due to technical and metallurgical developments and changes in iron and steel production, the consumption pattern of ferro-alloys has also changed, especially in industrialised countries:

- carbon steel is increasingly produced in electric arc furnaces from scrap, which allows recovery of the alloying elements, reducing the relative consumption of ferro-alloys;
- more efficient carbon steel production (continuous casting, for example) and a more advanced metallurgy have led to a significant drop in the specific consumption of manganese (from 7 kg/tonne of steel to 5 kg/tonne in 20 years) and of ferro-silicon (from 5 kg/tonne of steel to 3.5 kg/tonne in 20 years);
- a growing need for metallurgically sophisticated alloying elements (niobium, molybdenum), and for treatment elements (calcium), has led to an increased consumption of special alloys;
- an increasing production of stainless steel has led to a significant increase in the consumption of chromium alloys (mainly high-carbon ferro-chrome).

Western European consumption has been more or less stagnant, around 4.2 million tonnes per year, and its production has fallen from 4 million tonnes to 3 million tonnes since 1988.

1.7.4 Production sites

There are a number of companies producing different ferro-alloys in about 60 industrial production sites in Europe. The largest European ferro-alloy producing countries are Norway for the production of bulk ferro-alloys and France and Spain especially for the production of manganese and silicon alloys. Finland is a major producer of ferro-chrome from a local chrome ore mine. In Sweden, mainly ferro-chrome and ferro-silicon are produced. Special ferro-alloys like ferro-molybdenum, ferro-vanadium and ferro-titanium are produced in Austria and Germany.

1.7.5 Key environmental issues

Production of ferro-alloys generally involves the use of electric arc furnaces and reaction crucibles into which natural products (e.g. quartz, lime, various ores, and wood) with relatively fluctuating physical compositions are loaded. For this reason, the main environmental impacts of producing ferro-alloys are the emissions of dust and fume from the smelting processes. Dust emissions also occur from the storage, handling and pretreatment of raw materials where diffuse dust emissions play an important role. Depending on the raw material and the process used, other emissions to air are SO₂, NO_x, CO, CO₂, polycyclic aromatic hydrocarbons (PAH), volatile organic compounds (VOCs), and metals such as Hg, As and Cr. The formation of PCDD/F in the combustion zone and in the cooling part of the flue-gas treatment system (de novo synthesis) may be possible [226, Nordic Report 2008].

Significant process residues and by-products are slag, filter dust and sludge and spent refractories. These materials are already recycled and reused to a large extent where possible. Rich slag, meaning slag with a relatively high proportion of metal oxides, is used as raw material in the production of other ferro-alloys. For instance, rich slag from the production of ferro-manganese is one of the most important raw materials for the production of silico-manganese. Waste water is generated from cooling, granulation and other processes.

The ferro-alloys industry, whose basic tool is an electric arc furnace in which metal oxides are reduced by carbon, is a major consumer of energy and a producer of carbon dioxide (CO₂). It has therefore always regarded the reduction of energy consumption as a vital priority. The laws of thermodynamics, which govern the reactions used, limit the possible reduction of energy necessary for the smelting process. The reduction of the overall energy consumption is therefore in most cases only possible using an efficient energy recovery system. The recovered energy can be transferred into electrical energy or used as heat for various purposes. CO-rich exhaust gas from closed furnaces can also be used as secondary fuel or as a raw material for chemical processes. The recovery of energy reduces the use of other natural energy resources and therefore the impact of global warming.

1.8 Nickel and cobalt

1.8.1 Nickel

1.8.1.1 General information

Nickel [35, COM 1997], [92, Laine, L. 1998] is a silver-white metal with typical metallic properties. Although it was only discovered as a metal in 1751 its alloys have been used for several centuries, e.g. the Chinese had been making 'white copper' which resembled silver in appearance. Between 1870 and 1880, nickel's use in alloy steels was demonstrated and electrolytic nickel plating was successfully developed.

The great importance of nickel lies in its ability, when alloyed with other elements, to increase a metal's strength, toughness and corrosion resistance over a wide temperature range. Nickel is therefore an extremely important commercial element. Given these beneficial properties, nickel is used in a wide variety of products. Most primary nickel is used in alloys; the most important of which is stainless steel. Other uses include electroplating, foundries, catalysts, batteries, coinage and other miscellaneous applications. Nickel is found in transportation products, electronic equipment, chemicals, construction materials, petroleum products, aircraft and aerospace parts and equipment, and durable consumer goods. Nickel is a vital metal for industrialised societies.

Chemically, nickel resembles iron and cobalt, as well as copper. Nickel can form several compounds, e.g. sulphate, chloride, oxide and hydroxide. One property of nickel is its ability to react directly with carbon monoxide to form a binary carbonyl complex that is volatile at ambient temperatures. At moderate temperatures, nickel is corrosion-resistant against air, seawater and non-oxidising acids. Another property of nickel is its corrosion resistance to alkalis. In contrast, nickel is attacked by aqueous ammonia solutions.

1.8.1.2 Sources of materials

Nickel is a naturally occurring element that exists in nature mainly in the form of sulphide, oxide and silicate minerals. The deposits are of two main types.

- Nickel sulphides often occur together with economically recoverable amounts of copper, cobalt, gold, silver, platinum group metals and several other metals. The most important occurrences are in Africa, Australia, Canada and Siberia.
- Nickel laterites are products of the weathering of ultra-basic rocks that originally contained very small amounts of nickel. Over time impurities are washed out of the deposits and nickel is present as a complex oxide of silicon, iron and magnesium. Cobalt and iron are commonly associated with nickel, but laterites do not contain other valuable constituents. The most important occurrences are in the tropical areas of Southeast Asia, Australia, New Caledonia, South America, the Caribbean Sea and the Balkans area especially Greece, which is the only source of nickel ore in Europe at the time of writing (2014).

The complex metallurgy of nickel is reflected in the wide range of extraction and refining processes in operation. Every plant presents a unique set of process features and environmental issues. The nickel content of sulphidic ores can usually be concentrated several times by relatively economical ore-dressing techniques before the concentrate is smelted and refined to nickel products.

Laterite ores, in contrast, are amenable to only limited beneficiation by physical methods, e.g. magnetic or heavy media techniques, and therefore almost the entire volume of ore must go directly to metallurgical plants. Thus, laterite processing tends to be more cost-intensive, but mining costs are usually much lower than for sulphidic ores. These differences, plus the

availability of by-product value, can have an important influence on the viability of a specific deposit and whether refined metal or ferro-nickel is produced from it.

1.8.1.3 Production and use

Nickel products can be divided into three groups based on the industry classification that is recognised internationally:

Class I - refined nickel, nickel content of 99 % or more. The group includes electrolytic nickel, pellets, briquettes, granules, rondelles and powder/flakes.

Class II - charge nickel, nickel content of less than 99 %. The group includes ferro-nickel, nickel oxide sinter and utility nickel.

Class III - chemicals: nickel oxides, sulphate, chloride, carbonate, acetate, hydroxide, etc.

Global primary nickel production in 2005 was approximately 1.3 million tonnes and the production capacity approximately 1.45 million tonnes. In Europe the production capacity was approximately 229 000 tonnes and the consumption was approximately 410 000 tonnes in 2005 (see Figure 1.6). The actual production in total from the sites given in Table 1.25 was around 279 000 tonnes in 2008 compared to 182 000 tonnes in 2000.

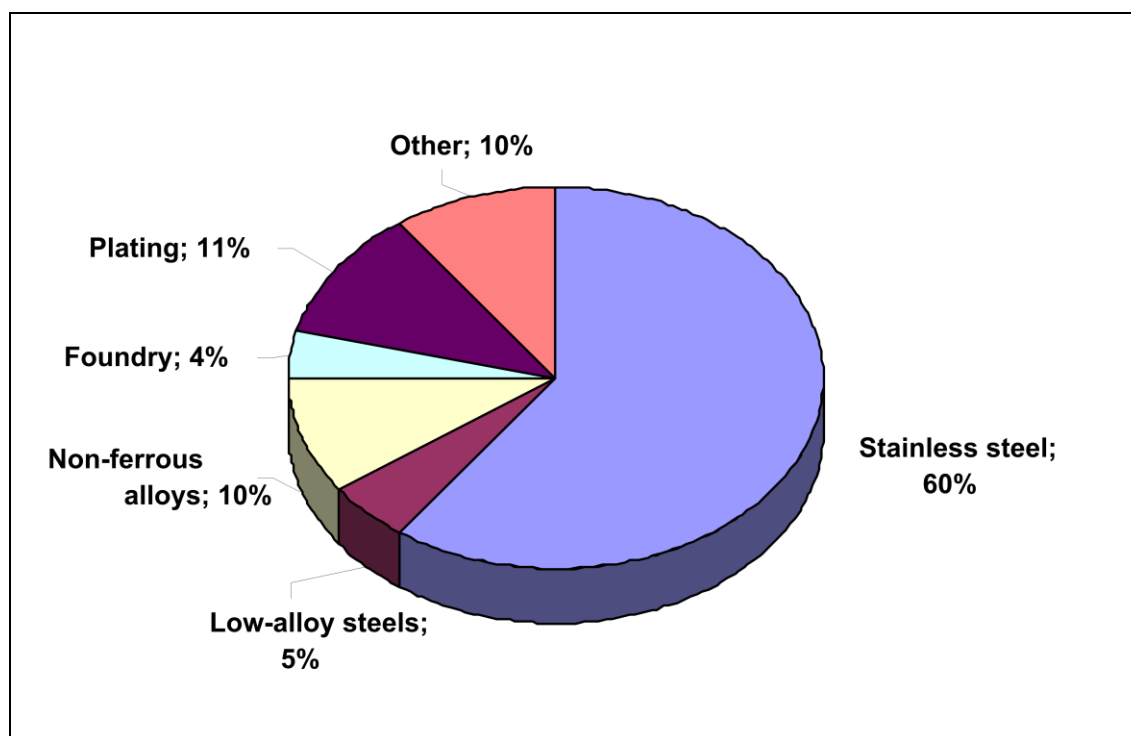

Figure 1.6: European uses of nickel in 2005

Growth in primary nickel use in western Europe between 1950 and 2005 (4.7 % yearly) exceeded the increase in global use but the rise since 2000 has been very subdued (slightly below 1 % yearly). The share of western Europe in global primary nickel use has been gradually declining, from its peak in 1998 (38 %) to 33 % in 2005.

1.8.1.4 Production sites

Table 1.25, Table 1.26 and Figure 1.7 show the production sites where nickel is produced in Europe (in 2013 it was reported that Treibacher is no longer producing nickel).

Table 1.25: Nickel production sites in Europe in 2006

Producer	Source of raw materials	Production capacity (t Ni/yr)	By-products
Boliden, Finland and Norilsk Nickel, Finland	Finland, Brazil and Australia	66 000	Cu precipitate Sulphuric acid Co sulphate solution Ni sulphate Ni hydroxycarbonate
Eramet, France	New Caledonia ⁽¹⁾	16 000	Cobalt chloride Ferric chloride
Xstrata, Norway	Canada and Botswana	86 000	Cu, Co, Sulphuric acid
Vale, United Kingdom	Canada ⁽¹⁾	41 000	Nickel metal
Treibacher, Austria	Secondary raw materials	< 1000	FeNi
Larco, Greece	Greece, Turkey	25 000	FeNi
Total		235 000	

⁽¹⁾ Nickel in matte.

Table 1.26: European production of nickel from 2006 to 2012 in tonnes per year

Country	2006	2007	2008	2009	2010	2011	2012
Finland	47 469	55 000	51 963	41 556	49 772	49 823	46 275
France	13 700	14 800	13 700	13 900	14 400	13 700	14 500
Greece	17 700	18 668	16 640	8269	13 960	18 530	18 630
New Caledonia	48 723	44 954	37 467	38 230	39 802	40 513	43 030
Norway	82 257	87 600	88 700	88 577	92 185	92 000	92 000
United Kingdom	36 750	34 050	40 800	17 800	31 600	37 400	34 300
Total	247 499	255 972	249 770	209 032	242 719	252 966	249 735

NB: Data relate to refined nickel plus the nickel content of ferro-nickel, nickel oxide and nickel salts.
Source: [363, Brown et al. 2013]

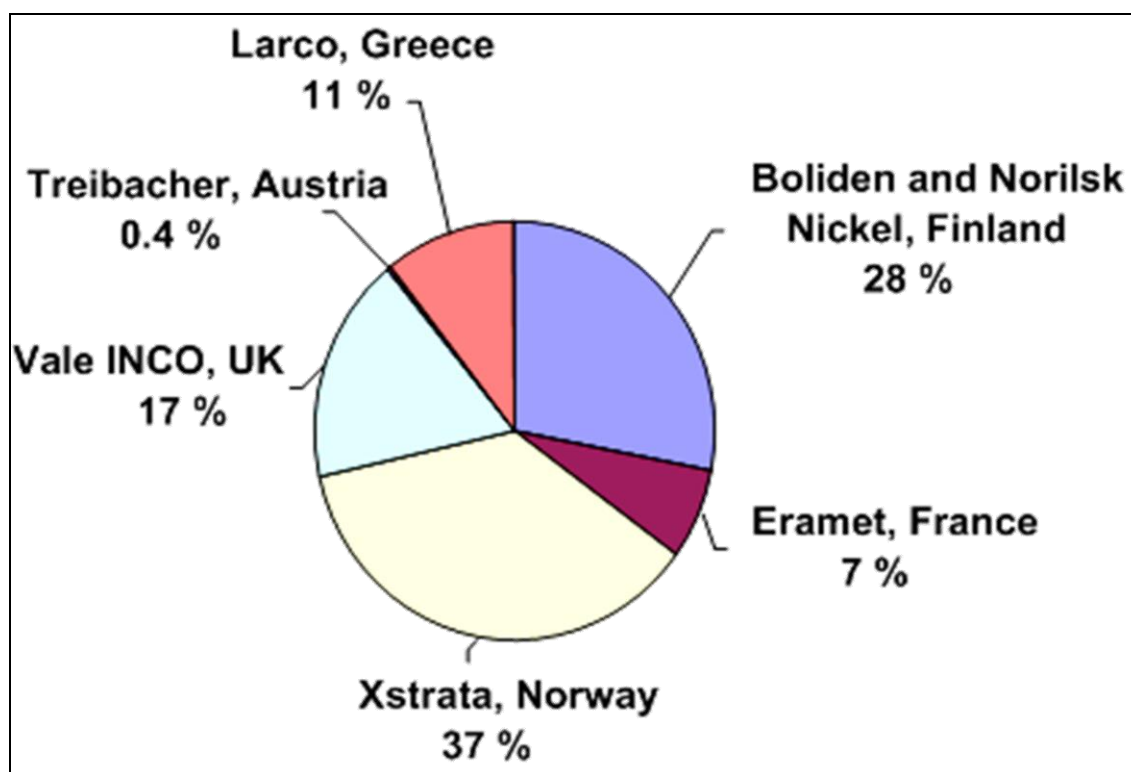

Figure 1.7: European nickel production in 2006

1.8.1.5 Key environmental issues

The emission of sulphur dioxide to air from the roasting and smelting of sulphidic concentrates is a potentially serious environmental issue. This problem has been effectively solved by the EU smelters which now achieve, on average, a 98.9 % fixation of the sulphur and produce sulphuric acid and liquid sulphur dioxide. Diffuse emissions of dust, metals and solvents are also an issue and need to be prevented or controlled. The use of chlorine in some processes is coupled with robust leak prevention measures and alarms.

The main environmental issues associated with the production of secondary nickel are also related to the exhaust gases from the various furnaces in use. These gases are cleaned in fabric filters and so can reduce the emissions of dust and metal compounds such as lead. There is also the potential for the formation of PCDD/F due to the presence of small amounts of chlorine in the secondary raw materials, and the destruction of PCDD/F is an issue that is being pursued.

Nickel is a sustainable commodity. Stainless steel and other nickel-bearing alloys are the primary sources of secondary nickel. It is estimated that around 80 % of the nickel produced is recycled from new and old stainless steel scrap and returns to that end use. Other nickel-bearing materials such as precipitates and residues are recycled to primary production.

In many applications, nickel alloys are essential and cannot be substituted with other materials. The use of nickel in applications where its strength, corrosion resistance, high conductivity, magnetic characteristics and catalytic properties are exploited is seen as a positive environmental benefit. Similarly the use of nickel in rechargeable batteries is also of environmental benefit.

The level of nickel in the atmosphere is limited by Directive 2004/107/EC relating to arsenic, cadmium, mercury, nickel and polycyclic aromatic hydrocarbons in ambient air. Nickel is also identified as a priority substance in Annex X to Directive 2000/60/EC establishing a framework for Community action in the field of water policy.

1.8.2 Cobalt

1.8.2.1 General information

Cobalt [35, COM 1997], [92, Laine, L. 1998] is a silver-white metal with typical metallic properties and it was first isolated in 1735. Pure metallic cobalt has few applications, but its use as an alloying element for heat- or wear-resistant applications and as a source of chemicals makes it a strategically important metal.

Although very little cobalt metal was used until the 20th century, its ores have been used for thousands of years as blue colouring agents for glass and pottery, e.g. on Egyptian pottery around 2600 BC and on Chinese pottery around 700 AD. The use of cobalt as metal dates from 1907 when E. Haynes patented a series of cobalt-chromium alloys named stellites that were the forerunners of modern superalloys. The ability of cobalt to enhance the properties of permanent magnets was shown in 1930.

Cobalt is used in alloys including superalloys for aircraft engines, magnetic alloys for powerful permanent magnets, hard metal alloys for cutting tool materials, cemented carbides, wear- or corrosion-resistant alloys, and electro-deposited alloys to provide wear- and corrosion-resistant metal coatings. Its use in rechargeable batteries has been a fast-growing application over the last few years.

Cobalt chemicals are used in rechargeable batteries; as pigments in the glass, ceramics and paint industries; as catalysts in the petroleum industry; as paint dryers; and as trace metal additives for agricultural and medical use.

1.8.2.2 Sources of materials

From the beginning of the 20th century, the world's main supply of cobalt moved from Europe to Africa, Australia, Russia and Canada. Production in 2007 was around 60 000 t/yr.

Cobalt is produced mainly as a by-product of the mining and processing of copper and nickel ores. Silver, gold, lead and zinc ores may also contain considerable amounts of cobalt but their processing does not always lead to its recovery. The sources of ores are:

- the copper-cobalt deposits in the Democratic Republic of the Congo and Zambia;
- the nickel sulphide ore bodies in Australia, Canada, Finland and Russia;
- the nickel oxide ore bodies in Cuba, New Caledonia, Australia and Russia.

Recovery from secondary sources can occur through the introduction of the recycled material at an appropriate stage in a primary refining or transformation process, depending on its technical and economical capabilities. Additional or pretreatment steps may be necessary. The final products can be cathodes, powders, oxides, salts or solutions.

Production comes from the following sources:

- nickel industry 43 %;
- copper industry & other 32 %;
- primary cobalt operations 25 %.

1.8.2.3 Production and use

Primary cobalt always occurs associated with other metals, particularly copper and nickel, and these are usually predominant. Depending on the feed material, several processes have been developed which can involve pyrometallurgical, as well as hydrometallurgical, steps. These steps produce either:

- a cobalt-rich solution in integrated plants;
- a cobalt-rich sulphide, hydroxide or carbonate if further refining is done elsewhere;
- a cobalt-rich alloy.

Further refining is hydrometallurgical although the final stage, the production of a commercial product, can be a high-temperature process; especially when the product is a powder and the refining activity is integrated into the transformation process. Worldwide production of refined cobalt in 2012 was approximately 77 505 tonnes.

Cobalt has a number of important applications which are summarised in Table 1.27.

Table 1.27: Breakdown of the total cobalt production to the different sectors of use

Uses	Breakdown of the total cobalt production
Batteries	25 %
Superalloys	22 %
Catalysts	9 %
Hard metals	12 %
Pigments	10 %
Tyre adhesives/ soaps/driers	6 %
Magnets	6 %
Others	10 %

The worldwide demand for cobalt in 2007 was around 55 500 t/yr and may be broken down on a regional basis as follows:

- Africa < 1 %;
- Asia 39 %;
- Europe 19 %;
- China 21 %;
- Americas 18 %;
- Oceania < 1 %;
- other 1 %.

The chemical sector is the largest consumer of cobalt accounting for about 50 % of total usage. The main application is in rechargeable batteries, a sector which has grown considerably in recent years. Other uses include cobalt for catalysts, paint/ink dryers, pigments and colours, electroplating, rubber adhesives, animal supplements and medical applications. Because cobalt confers both strength and surface stability to the metallic form, it plays an important part in superalloys, which account for about 22 % of cobalt consumption. These alloys are found in the turbine section of jet engines as they have properties which make them resistant to the conditions found in hostile environments, particularly when associated with heat and oxidation. Up until 2007, this was the largest single use sector for cobalt, but this has now been overtaken by rechargeable batteries. Cobalt is also used to produce industrial cutting tools (high-speed steels and diamond tools) and in special metallic applications where resistance to wear is required. Cobalt is also an important constituent in the special surgical alloys used to make

prosthetic hip and knee joints. The metal also has remarkable magnetic and paramagnetic qualities and is used in this application to a limited extent and also in magnetic tapes, though this application is now less important.

1.8.2.4 Production sites

Cobalt production is particularly associated with sites that produce nickel and also sites where copper is found. The most significant source of cobalt can be found in the Democratic Republic of the Congo and Zambia. Significant cobalt abundance is also found in association with the nickel operations in Canada and Russia. Finland, Norway, Belgium and China show significant production of refined cobalt, but this results mainly from the processing of imported ore and concentrate.

The worldwide production of cobalt is shown in Table 1.28.

Table 1.28: Worldwide cobalt production

Source	Refined cobalt production in 2007 (%)	Refined cobalt production in 2012 (%)
Africa	14.3	15
Australia	6.8	6.2
Belgium ⁽¹⁾	5.3	5.4
Brazil	2.3	2.3
Canada	10.6	7.7
China	25.0	38.4
Finland	17.1	13.6
France	0.6	0.4
India	1.8	1.1
Japan	2.0	3.3
Norway	7.4	3.8
Russia	6.8	2.8
⁽¹⁾ Includes refined production from Umicore's Chinese plant. Source: [363, Brown et al. 2013]		

1.8.2.5 Key environmental issues

The status of some cobalt compounds has a significant impact on the assessment of emissions. There are potential dust and metal emissions from grinding operations, and to a lesser extent from hydrometallurgical operations; chlorine in electrowinning and VOCs in solvent extraction; metals in water effluents of hydrometallurgical purification and recovery operations; and solid waste from purification and effluent treatment. The industry endeavours to work in a sustainable manner and uses a variety of techniques to recover and produce cobalt essentially depending on the raw materials and end-products mix, and so the actual occurrence and significance of these issues are therefore site-specific.

1.9 Carbon and graphite

1.9.1 General information

Carbon and graphite materials are mainly applied for the conduction of electrical power (cathodes and graphite electrodes) and as chemical reducing agents in the aluminium industry (anodes).

Carbon and graphite products can basically be divided into five product groups.

- Green mix and paste: mainly used in the aluminium and ferro-alloy steel industries.
- Anodes, mostly used in the aluminium industry as a reducing agent.
- Carbon and graphite, mostly used for the recycling of steel in the arc steel furnace and as cathodes in the aluminium industry.
- Speciality carbon and graphite: a wide range of products ranging from very high purity to very high mechanical strength and thermal resistance.
- Calcined anthracite and petroleum coke used as a re-carburiser in steel production.

The application of carbon specialities can be roughly divided into:

- high-purity carbon and graphite;
- highly mechanical and thermal applications;
- engineered products like carbon and graphite fibres;
- graphite foils and process equipment.

Carbon or graphite electrodes and furnace linings are produced for a variety of ferrous and non-ferrous metals production processes and are consumed during the production of the metals. More than 2000 other products of varying sizes, shapes and properties are produced for other applications. Carbon and high-purity graphite materials are essential for the production of semi-conductors and microchips, graphite electrodes for the recycling of steel scrap and highly chemical-resistant carbon and graphite are used for the recovery of residuals and the treatment of pollutants.

1.9.2 Sources of materials

The production of carbon and graphite materials are mainly based on petroleum coke and coal (anthracite) and a highly annealed coke based on coal tar. Petroleum pitch and coal tar pitch are used as a binder material, which is finally converted to inert solid carbon, coke or graphite during calcination, manufacture or use. Resin-based binder systems are used, which are cured before application.

The quality of coke and coal (anthracite) varies depending on the source but the most important factor is the sulphur content of the coke as this will be emitted as sulphur dioxide during calcination, manufacture or use. Normally, petroleum-based cokes or coal of a low or medium sulphur content are used for the major products like paste, anodes and electrodes.

The properties of the raw materials should be very consistent and are controlled by physical and chemical tests. New raw materials are tested in production trials to check their suitability and to adjust the production parameters to the new material. The final quality of raw materials is only based on the performance and acceptance of the manufactured carbon and graphite product.

Other materials are used in the production of specialist carbons and include metal and metal powders and a variety of resins.

1.9.3 Production and use

Coke or coal (anthracite) is usually bound with pitch (14–18 wt-%) to produce a green paste. For electrode paste production, calcined anthracite or petroleum coke is bound with pitch (20–30 wt-%). This paste then undergoes a number of shaping, baking, impregnation and graphitising stages to produce the final product. Green paste is also used directly for Søderberg electrodes. The baking process results in a loss in weight of ~ 5 % of the mass of the material. Packing coke is used in certain furnaces and in these cases is consumed at the rate of ~ 14 kg per tonne of product.

Carbon, calcined anthracite and graphite are mostly consumed during their application and converted into carbon dioxide (i.e. anodes for aluminium and steel electrodes). Steel production consumes electrodes at a rate of 1.5 kg to 3 kg per tonne of steel. Due to the significant reduction of the consumption rates in some industries, the quantities of carbon and graphite used for the production of aluminium and steel have been reduced.

The processing stage and size of the process varies depending on the product. The aluminium industry is by far the largest user of carbon materials in the form of prebaked anodes, Søderberg paste and cathode blocks. Generally, the specialist graphite products are smaller in scale than electrode products.

1.9.4 Production sites

Carbon and graphite products are made at 88 sites in Europe with an annual capacity of ~ 2 million tonnes (see Table 1.29).

Table 1.29: Production of some major carbon and graphite products in Europe in 2012 (tonnes)

	Unbaked green materials (including calcined anthracite + ramming paste)	Carbon electrodes	Graphite electrodes	Cathodes	Speciality graphite
Austria	35 000	0	30 000	0	0
France	0	0	45 000	45 000	0
Germany	134 500	0	79 000	0	9700
Italy	25 000	0	20 000	0	0
Netherlands	0	0	0	0	0
Norway	100 000	0	0	0	12 000
Spain	60 000	0	115 000	0	0
Poland	0	15 000	0	40 000	0
Sweden	0	0	0	0	36 000
UK	10 000	0	0	13 000	0
TOTAL	364 500	15 000	289 000	98 000	57 700
<i>Source: [381, ECGA 2012]</i>					

There is a strong tendency to close on-site anode production and to switch to an off-site supply. Some of the larger on-site producers with capacities of up to 150 000 t/yr also supply smaller primary aluminium smelters with anodes. The biggest carbon-producing plant in Europe and probably in the world is located in the Netherlands with a production capacity of 565 000 t/yr. Nevertheless, the majority of anodes are still produced in numerous on-site units.

Only a few companies produce cathodes due to the fact that there is a very long life cycle demanded by the aluminium industry. The life cycle of a cathode block ranges from 6 to 10 years. The properties have to guarantee a very good performance with respect to lifetime, electrical resistance and abrasion.

1.9.5 Key environmental issues

The main environmental impacts of these processes are the impacts of emissions to air of tars and PAH from the complex mixtures of binder and impregnation pitches, sulphur dioxide from coke and fuels and VOCs from impregnating agents. A variety of new abatement processes have been developed to destroy tars and PAH using novel afterburning systems. [116, VDI 1998].

The pitches release polycyclic hydrocarbon compounds while being carbonised. Benzo(a)pyrene or the PAH are used as a guideline substance to monitor the character of the emissions. Emissions occur during the storage of pitch, mixing and shaping, while carbonising in the baking furnaces and during impregnation. PAH in the atmosphere are limited by Directive 2004/107/EC relating to arsenic, cadmium, mercury, nickel and polycyclic aromatic hydrocarbons in ambient air.

If cokes with an increased sulphur content or sulphur additives are used during the production of speciality carbon products, sulphur dioxide might be formed and released.

Dust or particulate emissions are potentially significant. Fine-grained materials are normally not used for paste, anode or electrode production, but are for other products.

Water pollution is, in general, a minor issue for the carbon industry. Production processes are dry and generally use contained cooling water systems. Exceptionally, surface water for cooling may be used where it is suitable due to local conditions.

The most successful efforts are those of the carbon and graphite industry in recycling carbon materials (used and unused) and in finding new fields of applications for these materials, replacing other natural sources.

2 GENERAL PROCESSES AND TECHNIQUES

There are many processes, variations in equipment, and techniques used in the production of non-ferrous metals. Many of the techniques and individual stages of the production processes are common for most of the non-ferrous metals produced, and therefore, to avoid excessive repetition, these common stages are described together. These common stages are:

- management systems;
- energy management;
- monitoring;
- diffuse emissions;
- raw material management;
- metal production processes;
- channelled emissions to air;
- water and waste water management;
- residue management;
- decommissioning;
- safety issues.

Techniques for reducing the environmental impact of an installation can be described in three categories:

1. management techniques: relating to the systems and procedures for designing and operating a process and for training operators and other staff;
2. process-integrated techniques: relating to the use of techniques to prevent or reduce emissions from activities such as storage, reaction, separation and purification;
3. energy reduction and abatement techniques: relating to end-of-pipe techniques to reduce emissions to air, water and land.

This chapter briefly describes the general techniques that are used in this sector. An indication is given (where possible) of the techniques that are able to prevent or reduce emissions to each environmental medium. This chapter also indicates where these techniques can be used in the various process stages to improve existing processes. This theme is developed in the metal-specific chapters that follow.

The metallurgical production processes for the eight groups identified by the Technical Working Group are covered individually in Chapters 3 to 10. The techniques to consider in the determination of BAT in these chapters include more detailed process descriptions, examples and diagrams. They also provide more detail of how the integrated process operates and where the variations in the techniques to consider in the determination of BAT described in Chapter 2 are used.

A significant number of installations produce a number of metals from different groups or may have associated processes integrated with them. Examples are the processing of bauxite at an aluminium smelter; the presence of an anode production plant at an aluminium smelter; or the production of a range of different metals from complex raw materials, in particular copper, lead, zinc and precious metals.

Table 2.1 shows processes that may form integrated installations and explains where these sections and chapters are, and this shows how a complex plant can be approached.

Table 2.1: Processes that may form integrated installations

Materials produced in the same installation	Chapters that contain process and other details	Chapters that contain overview of the processes	Comments
Alumina from bauxite in an Al smelter	Chapter 4	Chapter 4	Integrated with a few installations
Prebaked anodes produced in an aluminium smelter	Chapter 4	Chapter 4	Factors of common storage and mixing techniques taken into account
Lead, zinc or precious metals with the production of copper	Chapters 5, 6 and 7	Chapter 3	Some duplication between Chapter 3 and the other chapters
Nickel, cobalt and copper	Chapters 3 and 9	Chapter 9	
Mercury during the production of other metals	Chapter 2	Chapters 3 and 5	Mercury removal from smelter gases before acid plant
Ferro-alloys (FeCr, FeSi, FeMn, etc.)	Chapter 8	Chapter 8	Factors of common abatement techniques. Common energy recovery techniques

Chapter 2 should be used in conjunction with Chapters 3 to 10 to give the complete production cycle, e.g. Chapters 2 and 3 will give the overall process stages for the production of copper and its alloys.

2.1 Management systems

Effective management is important for achieving good environmental performance. It is an important component of BAT and forms part of the definition of techniques given in Article 3 of the Directive.

The work undertaken in preparing this document has shown that there are many significant differences between the environmental performance of a process that is managed and operated well and an identical process that is managed and operated poorly. Management and communication systems are some of the most significant factors in this difference.

Achievement of a good performance requires commitment at all levels within a company, starting at board or policy level, and includes the site management, supervisors and operators. The system should establish objectives, set targets and communicate instructions and results. Environmental management systems such as ISO 14001 and EMAS, management systems for occupational health and safety such as OHSAS 18001, or a quality management system such as ISO 9000 can assist by formalising the system.

Although they are not a requirement of the IED, an installation should consider the benefits that can arise from adopting such a system. The techniques used can also improve economic performance by improving operating efficiency, reducing costs such as energy or disposal costs and improving metal yields. These techniques are therefore essential factors for a modern installation.

2.1.1 Management policy and commitment

An effective management system can include the following factors.

- Identification of all health, safety and environmental impacts of activities, products and processes, e.g. OHSAS 18001.
- A commitment to develop and implement the measures identified.
- Communication of the policy to employees and contractors to ensure that they are aware of the commitment and are involved in its delivery.
- Use of a clear structure for managing environmental issues that is fully integrated with the wider company and site decision-making systems.
- The environmental performance of the process is highly dependent on the attention and awareness of the process operator.
- The overall environmental performance can be monitored on a regular basis and the results can form part of the management assessment process. Environmental performance indicators can be devised and disseminated to operators, and feedback from operators can be obtained and used.
- Contingency plans can be prepared which identify the potential types of incident that can occur and provide clear guidance on how they will be managed and who is responsible. Procedures can be prepared to identify, respond to and learn from all complaints and incidents.
- Where new processes are being commissioned, or where existing processes are being recommissioned after alterations, a commissioning plan can be prepared that clearly identifies the issues and the person(s) responsible for the environmental performance of the process during the commissioning period.

2.1.2 Design and maintenance

Good design and maintenance are key for the achievement of a high level of protection of the environment as a whole, and can help highlight the effect of existing plants and any new or substantially changed processes on the protection of air, water and land. An adequate supply of critical spare parts for security and for the environment should be kept, to fix problems and therefore to minimise accidental emissions and their impact. Several companies specialise in design and maintenance. Good design and maintenance procedures include the following steps.

- Considering the environmental implications (including noise) of a new or substantially modified process or raw material at the earliest stages of the project, and continuing to review this at regular intervals thereafter. Formal methods such as design failure mode and effects analysis (dFMEA) and process failure mode and effects analysis (pFMEA) can be useful in ensuring robust and effective control of risks. This is the most cost-effective time to introduce improvements to the overall environmental performance. An audit trail of the design and decision-making process is a useful method to show how various process and abatement options were considered. Commissioning issues should be planned for new or modified plants.
- Considering potential diffuse emissions at all stages.
- Using and recording a programme of preventive maintenance. This should be coupled with diagnostic testing where appropriate.
- Holding spare parts of equipment important for safety and for environmental protection. [243, France 2008]
- Examining local extraction systems regularly and repairing defects or damage promptly.
- Making all staff aware of the role they can play by being vigilant, for example, in relation to damage to hoods and ductwork or plant failures. Appropriate procedures should be used to encourage staff involvement and to encourage them to respond to reports.
- Using an internal procedure to authorise modifications and to undertake checks after modifications before a process starts up.

2.1.3 Training

Training is an important factor and the following points should be included in training schedules.

- All staff should be aware of the implications for the environment of the process and their work activities.
- There should be a clear statement of the skills and competencies required for each job.
- Training given to staff involved in a process operation should include the environmental implications of their work and the procedures for dealing with incidents.
- Records of the training given to process operation staff can be very useful in ensuring progressive and complete training.
- Training other departments about environmental issues and the consequences that can affect the installation can also be effective in preventing conflicts that might affect environmental performance. For example, finance and sales teams can have significant influences on environmental performance. Full accounting measures can identify excess raw material usage and can identify true energy and disposal costs for process stages; unplanned deliveries and sales can lead to production short cuts and cause incidents.

2.2 Energy management

Article 11(f) of the IED requires that energy is used efficiently. This document includes comments on energy use and its place in the assessment of BAT under each of the metal production chapters. Energy use in the non-ferrous metals industry is covered by a series of reports prepared by the Centre for the Analysis and Dissemination of Demonstrated Energy Technologies (CADDET). These reports have been used extensively in comparing techniques. The BREF on Energy Efficiency [333, EC 2008] should also be referred to.

For non-ferrous metals production, most concentrates are imported into Europe from a variety of sources worldwide, and therefore energy is used for transport. It is important then to use indigenous secondary raw materials, such as scrap metal and other residues, due to the benefits of reduced energy consumption.

In the copper sector, secondary raw materials account for the production of about 45 % of EU copper, but in some cases, such as brass rods, the product is made almost entirely from recycled copper and brass, with only a small input of primary zinc. When copper cathodes are produced from recycled materials, there is a saving of approximately 650 000 tonnes of CO₂, because specific direct emissions of secondary smelters are four times lower than those from primary smelters.

In the aluminium sector, the production and refining of secondary aluminium is also much less demanding in terms of energy; accounting for a consumption per kg of about 5 % of the energy needed to produce primary aluminium.

2.2.1 Applied processes and techniques

Energy and heat recovery is practised extensively during the production and casting of non-ferrous metals. A technique reported in the Energy Efficiency BREF [333, EC 2008] is the use of an energy efficiency management system. There are also international standards (e.g. ISO 50001) providing a framework for an energy-efficient management system.

Pyrometallurgical processes are normally highly heat-intensive and the process gases contain a lot of heat energy. As a consequence, regenerative burners, recuperative burners, heat exchangers and boilers are used to recover this heat. Steam or electricity can be generated for use on or off site, for example in district heating schemes or to preheat process or fuel gases [115, ETSU (UK) 1996]. The techniques used to recover heat vary from site to site and are governed by a number of factors, such as the exergetic content, the potential uses for the heat and energy on or near the site, the scale of operation and the potential for gases or their constituents to foul or coat heat exchangers.

The following examples are typical and constitute techniques to consider for use in the processes to produce non-ferrous metals [115, ETSU (UK) 1996]. The techniques described can be incorporated into many existing processes.

The hot gases produced during the smelting or roasting of sulphidic ores are almost always passed through steam-raising boilers. The steam produced can be used to produce electricity and/or for heating requirements. An example of this is where a copper smelter produces 25 % of its electrical requirements (10.5 MWe) from the steam produced by the waste heat boiler (WHB) of a flash furnace. In addition to electricity generation, steam is used as process steam in the concentrate dryer, and residual waste heat is used to preheat the combustion air.

Other pyrometallurgical processes are also strongly exothermic, particularly when oxygen enrichment of combustion air is used. Many processes use the excess heat that is produced during the smelting or conversion stages to melt secondary materials without the use of additional fuel. For example, the heat given off in the Peirce-Smith converter is used to melt

anode scrap. In this case, the scrap material is used for process cooling and the additions are carefully controlled. This avoids the need for cooling the converter by other means at various times of the cycle. Many other converters can use scrap additions for cooling, and those that cannot can be subjected to process developments to allow it.

The use of oxygen-enriched air or oxygen in the burners reduces energy consumption by allowing autogenous smelting or the complete combustion of carbonaceous material. Waste gas volumes are significantly reduced, allowing smaller fans, etc. to be used.

Furnace lining material can also influence the energy balance of a melting operation. In this case, low-mass refractories are reported to have a beneficial effect, by reducing the thermal conductivity and storage in an installation [103, COM 1998]. This factor must be balanced against the durability of the furnace lining, and metal infiltration into the lining and may not be applicable in all cases.

The separate drying of concentrates and raw materials at low temperatures reduces the energy requirements. This is due to the energy required to superheat the steam within a smelter and the significant increase in the overall gas volume due to the steam produced. The larger gas volume increases the heat removed from the furnace and, consequently, the fan that is needed to deal with the increased gas volume must be increased in size. This drying might be conditioned in some cases by the need to maintain a minimum moisture content in order to prevent dust emissions and/or avoid autoignition.

The production of sulphuric acid from the sulphur dioxide emitted from the roasting and smelting stages is an exothermic process and involves a number of gas cooling stages. The heat generated in the gases during conversion, and the heat contained in the acid produced, can be used to generate steam and/or hot water.

Heat is recovered by using the hot gases from the melting stages to preheat the furnace charge. In a similar way, the fuel gas and combustion air can be preheated, or a recuperative burner can be used in the furnace. Thermal efficiency is improved in these cases. For example, nearly all cathode/copper scrap melting shaft furnaces are fired with natural gas; the design offers a thermal efficiency (fuel utilisation) of 58 % to 60 %, depending on the diameter and height of the furnace. Gas consumption is approximately 330 kWh/tonne of metal. The efficiency of a shaft furnace is high, principally due to the charge preheating within the furnace. There may be sufficient residual heat in the exhaust gas to be recovered and reused to heat combustion air and gas. The heat recovery arrangement requires the diversion of the furnace stack gases through a suitably sized heat exchanger, transfer fan and ductwork. The heat recovered is approximately 4 % to 6 % of the furnace fuel consumption.

Cooling prior to a fabric filter installation is an important technique as it provides temperature protection for the filter and allows a wider choice of fabric. It is sometimes possible to recover heat at this stage. For example, in a typical arrangement of a shaft furnace to melt metal, gases from the top of the furnace are ducted to the first of two heat exchangers that produces preheated furnace combustion air. The temperature of the gases after this heat exchanger can be between 200 °C and 450 °C. The second heat exchanger reduces the gas temperature to 130 °C before the fabric filter. The heat exchangers are normally followed by a cyclone, which removes larger particles and acts as a spark arrestor.

Carbon monoxide produced in an electric or shaft/blow furnace is collected and burnt as a fuel for several different processes or to produce steam, e.g. for district heating or other energy purposes. Significant quantities of the gas can be produced and examples exist where a major proportion of the energy used by an installation is produced from the CO collected from an electric arc furnace installation. In other cases, the CO formed in an electric furnace is burnt in the furnace and provides part of the heat required for the melting process. The applicability of this technique might be restricted by the composition of the exhaust gas and by the type of process (e.g. batch production).

The recirculation of contaminated exhaust gas back through an oxy-fuel burner also gives significant energy savings. The burner recovers the waste heat in the gas, uses the energy content of the contaminants and removes them [113, ALFED 1998]. Such a process can also reduce nitrogen oxides.

The use of the heat content of process gases or steam to raise the temperature of leaching liquors is practised frequently. In some cases, part of the gas flow can be diverted to a scrubber to return heat to the water, which is then used for leaching purposes. The cooled gas is then returned to the main flow for further abatement.

During the smelting of electronic scrap or battery scrap, the combustible plastic content contributes to the energy that is used in the smelting process and reduces the amount of fossil fuel that is needed.

The advantage of preheating the combustion air used in burners is well documented. If an air preheat of 400 °C is used, there is an increase in flame temperature of 200 °C, while if the preheat is 500 °C, the flame temperature increases by 300 °C. This increase in flame temperature results in a higher melting efficiency and a reduction in energy consumption. It has been reported that regenerative burners can be used to preheat the combustion air to 900 °C, which reduces the energy consumption by 70 %. This is well established and payback times of less than one year are achieved.

The alternative to preheating the combustion air is to preheat the material charged to the furnace. Theoretically 8 % energy savings can be obtained for every 100 °C preheat, and in practice it is claimed that preheating to 400 °C leads to 25 % energy savings while a preheat of 500 °C leads to 30 % energy savings. Preheating is practised in a variety of processes, for example preheating of the furnace charge using the hot furnace exhaust gases during the production of ferro-chrome and secondary aluminium. In the latter case, the use of a charge preheating chamber is very effective. Hydrocarbons are emitted during charge preheating, as the contents are pyrolysed from the scrap. The gases that are produced are directed to the furnace burner system, which destroys the hydrocarbons and utilises the energy content for melting.

Under many circumstances, the predrying of raw materials offers energy savings because the latent heat added to the steam produced is not wasted, and also gas volumes are lower and so fans and abatement plants need do not need to be too large and need not have higher energy consumption.

Gases from anode furnaces should be considered for use in drying or other process stages. Hot gases extracted from launders can be used as preheated combustion air.

Figure 2.1 illustrates the energy balance of the Contimelt process, which uses the rising, hot gases in a shaft furnace to preheat the charge.

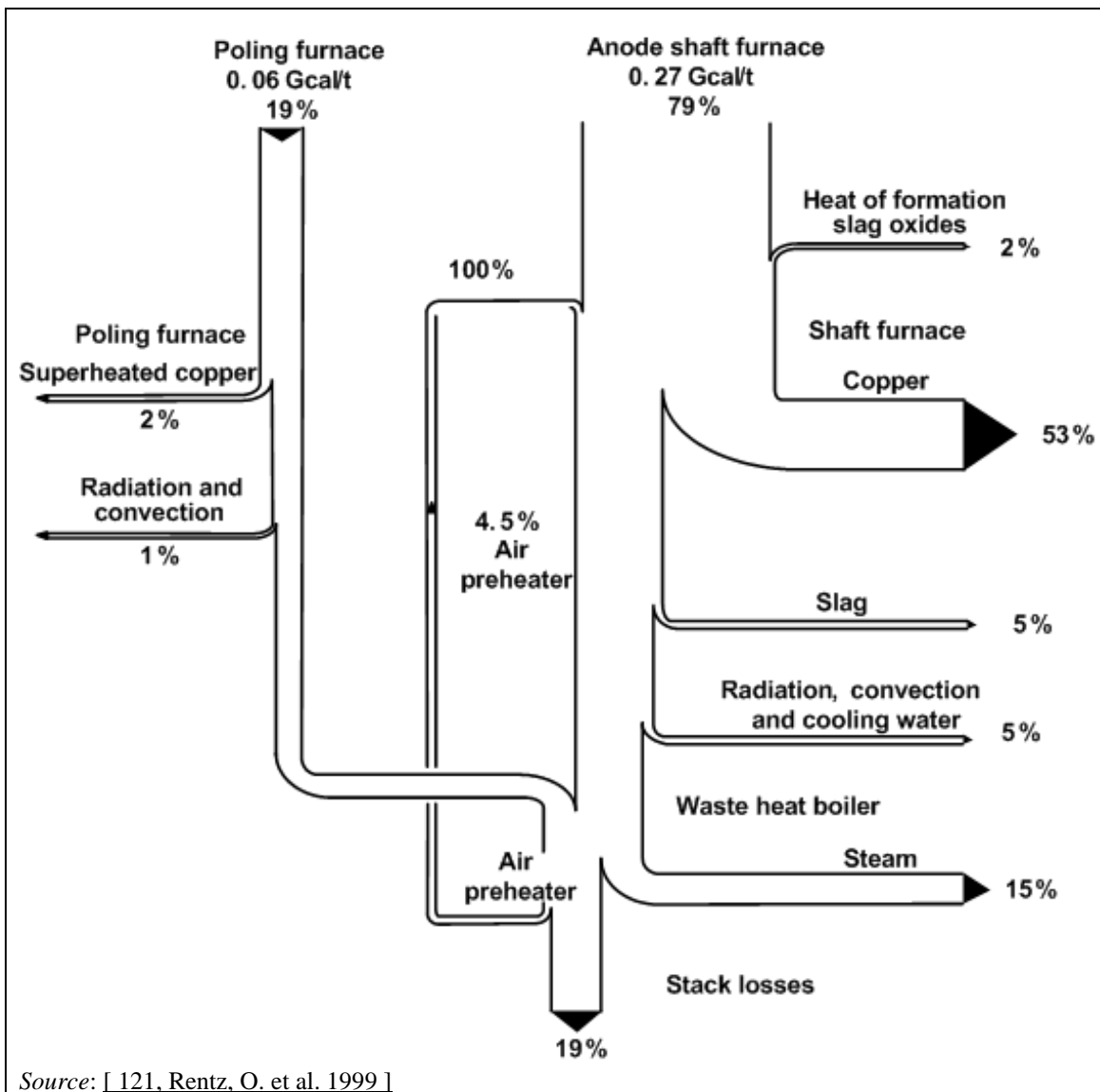

Figure 2.1: Energy balance of the Contimelt process

Heat and energy recovery is clearly an important factor in the non-ferrous metals industries, and reflects the high proportion of costs that energy represents. Many techniques for energy recovery are relatively easy to retrofit [115, ETSU (UK) 1996], but occasionally there may be problems of deposition of metal compounds in heat exchangers. Good design therefore incorporates sound knowledge of the compounds released and their behaviour at various temperatures. Heat exchanger cleaning mechanisms are also used to maintain thermal efficiency.

Whilst these savings are examples of savings in individual components of installations, the application and the economics are dependent upon the site- and process-specific conditions.

2.3 Monitoring

This section is intended to ensure that the emissions reported in this document are measured in such a way that the results are representative, mutually comparable and clearly describe the relevant operating state of the plant. The methods and instruments used for sampling and analysis are the relevant European, national or international methods (e.g. European Committee for Standardisation (CEN); ISO) [293, COM 2017]. General principles are given below.

The measurement of emissions is used to determine the substances in the clean gas or waste water so that they can be reported, used to control the process or abatement plant, or used to predict environmental impacts. The techniques are generally covered in the Reference Report on Monitoring (ROM) [293, COM 2017].

Prior to measurement, plans can be made to take account of:

- the mode of operation;
- the operating state of off-gas purification or effluent treatment plants;
- operating conditions in the plant (continuous, discontinuous, start-up and shutdown operations, load change); and
- the effect of thermodynamic interference factors.

Dilution of the gases or waste water is not considered acceptable. Factors should be taken into account such as variations of the process, the nature and potential hazardousness of the emissions, and the time needed to obtain a measurable amount of pollutant or representative information. These factors can then form the basis for the selection of operating conditions at which the highest emissions may be recorded, the number and duration of measurements, the most appropriate method of measurement and the position of the measurement locations. For waste water emissions, qualified random samples can be used or 24-hour composite samples based on flow-proportional or time-averaged samples can be taken.

For continuous operations, a minimum sample collection time or measurement time of half an hour (half-hourly mean value) is usually necessary. If dust contents are low or if PCDD/PCDF are to be determined, longer measurement times and, consequently, other reference times may be necessary because of the limitation of detection. Sampling or measuring should take place only during the operation of the process and dilution air should be excluded. For continuous operation when there are only slight fluctuations in the emission characteristics, three individual measurements can be performed at the highest emission level. If it is anticipated that the emission levels will be very variable during continuous operation, more measurements can be carried out; the sampling and averaging time being limited to the emissions phase.

For batch operations, the measurement time and the averaging time should be modified so that a sample or samples over the whole batch can be taken. These results can be used to calculate averages or to show where peaks occur during the cycle. Again, sampling or measurements should only be taken during periods of operation and dilution air should be excluded.

2.3.1 Sampling locations

The sampling points should meet the requirements of the relevant national guidelines. The sampling points should normally:

- be clearly marked;
- if possible, have a disturbance-free flow in the measurement section;
- have monitoring points that can be closed;
- have the required energy supplies;
- have sufficiently large working platforms; and

- ensure that the requirements for safety at work are met.

2.3.2 Components and parameters

The components that are measured in the non-ferrous metals sector include dust, metals, sulphur dioxide, total carbon (also VOCs, tars and hydrocarbons), PCDD/F, oxides of carbon and nitrogen oxides. Acids such as HCl and HF are monitored for some processes, as are chlorides and fluorides. Specific determinants include PFCs for primary aluminium and PAH for anode baking, primary aluminium using Söderberg technology, and carbon and graphite. Some determinants are specific to some of the reagents used for precious metals production. The components are reported in the metal-specific chapters and the methods of sampling and analysis are given in the relevant national and international guidelines on monitoring and analysis [317, UBA (D) 2009].

The analysis of some parameters may be covered by methods established by other bodies, for example OSPARCOM. The measurement and detection of PAH in certain sectors (e.g. anode, primary aluminium using Söderberg technology and carbon and graphite) is done using BaP as a marker.

2.3.3 Reference conditions

For emissions to air, the following off-gas parameters should also be determined to convert the emission concentrations obtained to standard conditions of 273 K, 101.3 kPa, measured oxygen content and dry gas:

- the volumetric off-gas flow (in order to calculate the concentration and emission mass flow);
- the off-gas temperature;
- the water vapour content of the off-gas;
- the static pressure in the off-gas duct; and
- the atmospheric pressure.

The production rate can also be reported so that the emissions can be reported as specific emissions per tonne of metal. The specific gas volume in Nm³ per tonne of metal can also be calculated.

2.3.4 Continuous and periodic measurement of channelled emissions

Continuous monitoring of emissions involves measurement with an automated measuring system (AMS) permanently installed on site.

The continuous measurement of several components in gases or in waste water is possible and in several cases accurate concentrations can be reported continuously or as mean values over agreed time periods (half-hourly, daily, etc.). In these cases, an analysis of the averages and the use of percentiles can provide a flexible method of demonstrating compliance with permit conditions and the averages can be easily and automatically assessed. Member States usually have their own methods of assessing compliance which, for example, allow for short-term peak emissions.

For emission sources and components that can have a significant environmental impact, continuous monitoring should be specified. Dust can have significant environmental and health effects. In the metals sectors, dusts can contain toxic components and the continuous monitoring of dust is important not only for compliance assessment but also to assess whether any failures

of the abatement plants have taken place (e.g. bag bursts). To detect bag failures, concentration trends can be analysed or peak emissions, e.g. during reverse jet cleaning of the bags, can be observed. Modern dust monitors can interface with the cleaning system to identify which section of the filter contains leaking bags, so that maintenance of the filter can take place.

Methods are available to continuously measure:

- dust;
- SO₂;
- NO_x;
- CO;
- gaseous fluorine and its compounds;
- gaseous chlorine and its compounds;
- total organic carbon;
- mercury in the vapour phase.

Competent authorities may require continuous measurement depending on the mass flow of the pollutant. Conductivity, turbidity, pH, flow rate, temperature and some ionic species can be continuously monitored for water.

Even in cases where absolute values may not be considered reliable, the use of continuous monitoring can be used to give trends in emissions and as control parameters for the process or abatement plant and are therefore very important.

Periodic measurements involve the determination of a measurand at specified time intervals using manual or automated methods. The specified time intervals in general are regular (e.g. once a month or once/twice a year). The sampling duration is defined as the period of time over which the sample is taken. In practice, sometimes the expression 'spot sampling' is used in a similar way to 'periodic measurement'.

Some physical parameters can also be used as surrogate parameters to give an indication of the presence of certain components in the gas stream. For example, the presence of an anode effect can indicate the production of PFCs in primary aluminium production and the temperature, oxygen and dust content of the gas can give an indication of the destruction of PCDD/F. The pH can also be used to indicate the effective precipitation of metals.

2.3.5 Diffuse emissions measurement

It is generally recognised that diffuse emissions pose a particular challenge due to their nature. Measurement methodologies [323, VDI 2008], [324, VDI 2008] have been used in order to determine the following:

- The global effect of the diffuse emissions from a specific plant. Measuring the emissions near a plant can give useful information, although the variations in wind direction can make the results difficult to interpret. When enough measurement devices are in place near a plant, an estimate can be made of the global amount of emitted substances that can be uniquely linked with the plant under consideration (metals, acid mist, etc., but not for example dust). The accuracy of such an exercise, however, is no better than 50 %, making this method only suited for evaluations over longer time periods. Also, the accuracy of this method at lower levels is very questionable.
- The relevant sources of diffuse emissions. Diffuse emissions arise from various sources, and the quantification of diffuse emissions depends on the type of emissions source.

Several methods that have been used to estimate diffuse emissions have been reported [229, IZA plant data 2008], as detailed below.

- For diffuse emissions from buildings, including measurements to determine the flow rate and concentration through vents and windows. One reliable method has been used for a number of years at one site [160, Steudtner 1998]. Another method used to measure the volume and composition of diffuse dust emissions has proven to be relatively reliable at a primary copper smelter [158, Petersen, K. 1999], with the monitoring results given in Table 2.2. The results show that the magnitude of diffuse emissions can be much more significant than collected and abated emissions. The lower the controlled emissions, the more significant the diffuse emissions.

Table 2.2: Comparison of abated and diffuse dust loads at a primary copper smelter

	Dust emission (kg/yr)	
	Before additional secondary gas collection (1992)	After additional secondary gas collection (1996) ⁽¹⁾
Anode production (t/yr)	220 000	325 000
Diffuse emissions:		
Total smelter	66 490	32 200
Smelter roof line	56 160	17 020
Controlled emissions (primary smelter):	7990	7600
Smelter/Acid plant	2547	2116
Secondary hoods stack		
⁽¹⁾ Emissions after an investment of EUR 10 million to install an improved diffuse gas capture and treatment system. Additional energy = 13.6 GWh/yr. Source: [158, Petersen, K. 1999]		

The flow conditions of the sources of diffuse emissions are not stable, and so sampling emissions from roof vents is not accurate. Accuracy can be improved if the cross-section of the measurement plane of roof-line vents is subdivided into sectors of identical surface area (grid measurement). During the measurements, sampling probes are installed at selected locations. The sampling equipment employed must be designed for infinitely variable suction control. By selecting different sampling probe diameters, the sample flow rate can be adapted to the prevailing off-gas flow velocity. The dust content of the sample gas streams is collected on a filter medium and determined by gravimetric methods [293, COM 2017].

- Continuously monitoring the dust concentration in the workplace using fixed or portable samplers can identify the main sources of diffuse emissions. The results can then identify and provide information on the critical steps in the processes, if the results are correlated with the process operations that are taking place during sampling [229, IZA plant data 2008].
- Using emissions characteristics (emission factors) as a basis for estimating diffuse dust emissions occurring during storage, handling and transportation of bulk materials (input materials, scrap, etc.). The use of emission factors in this context can only give a rough guide to the magnitude of the emission.
- Using reverse dispersion modelling (RDM) [322, CEN 2008] to predict the relevant dust sources. Generally, the results obtained are valuable within the particular installation and for the components measured. Some examples of good application have been reported in Belgium [298, Mensink 2005]. The application of this method becomes difficult in situations where the amount of dust generated at the plant is small compared to the background dust. This method can be both costly and time-consuming. RDM is described in the CEN methodology EN 15445-2008.
- Release of tracers (marker gases) at a known rate from certain points in an installation and measuring them downwind along with the pollutants. The results can be used to estimate pollutant emissions based on assumptions of diffusion and absorption.

Some installations use these measurement methodologies to estimate diffuse emissions at their sites. These methodologies have been developed on a trial and error basis with local expertise, knowledge of local conditions, experience, specific configuration of the plant, etc. They are not at a stage where they can yield accurate and reliable actual figures, but they can show indicative emission levels or the emission trends over a certain period of time.

There are no measurement methodologies applicable for general use by all sites, and no measurement methodology is the same from one site to another. There are significant effects from other sources in the vicinity of a site, such as other operations, traffic and other sources that make extrapolation very difficult. The results obtained are therefore relative or benchmark values that can indicate the reductions achieved by measures taken to reduce diffuse emissions.

The assessment of the impact of diffuse emissions and their reduction over time should be compared with the relative proportion of diffuse and point source emissions from the particular site. Comparison of these results with environmental quality standards (EQS), occupational exposure limit (OEL) or predicted no effect concentration (PNEC) values which are based on sound science is used to assess the share or impact of diffuse emissions in the surrounding environment.

The sampling locations must meet occupational health and safety standards, be readily accessible and adequately sized.

The measurement of diffuse emissions from area sources is more complex and requires more elaborate techniques because:

- the emissions source can be a large area and may only be roughly defined;
- the emissions characteristics are governed by meteorological conditions and are subject to major fluctuations;
- the uncertainties associated with the measured data can be substantial.

Light detection and ranging techniques (LIDAR) may also be used to measure dust, fumes and some diffuse gaseous components, such as SO₂ and VOCs.

2.4 Diffuse emissions

Diffuse emissions are a very important source of emissions in the NFM sector. Their magnitude can be much more significant than collected and abated emissions (some sources estimate that diffuse emissions can be more than two to three times the quantity of controlled emissions [219, VDI 2007], although this is very site-specific and time-related).

Diffuse and fugitive emissions have been defined in the Reference Report on Monitoring (ROM) [293, COM 2017]

Diffuse emissions are emissions arising from the direct (non-channelled) contact of volatile compounds or dust with the environment under normal operating conditions. These can result from:

- inherent design of the equipment (e.g. filters, dryers);
- operating conditions (e.g. during transfer of material between containers);
- type of operation (e.g. maintenance activities);
- or from a gradual release to other media (e.g. to cooling water or waste water).

Diffuse emission sources can be point, linear, surface or volume sources. Multiple emissions inside a building are normally considered to contribute to diffuse emissions when the pollutants leave the building by natural ventilation, whereas a forced ventilation system exhaust is classed as a channelled emission.

Examples of diffuse emissions include emissions from storage facilities during loading and unloading, storage of dusty solid matter in the open air, emissions from furnace operations such as charging and tapping, and emissions from electrolytic cells, processes involving solvents, etc.

Fugitive emissions are emissions into the environment resulting from a gradual loss of tightness of a piece of equipment designed to contain an enclosed fluid (gaseous or liquid). Typically this could be caused by a pressure difference and a resulting leak. Fugitive emissions are a subset of diffuse emissions.

Examples of fugitive emissions include leakages from a flange, a pump or a piece of equipment and losses from the storage facilities of gaseous or liquid products.

For the prevention of diffuse emissions from metal production processes, an indication is given in Section 2.4.3, while a detailed description can be found in the metal-specific chapters.

2.4.1 Sources of diffuse emissions

In metallurgical plants, diffuse emissions may arise from the following sources.

- transport, unloading, storage and handling systems, with the emissions directly related to wind velocity;
- suspension of dust from roadways due to traffic movements and contamination of vehicle wheels and chassis;
- the resuspension of dusty materials from abandoned workings, storage areas or disposal points due to wind action, which is related to wind velocity cubed;
- the production processes themselves.

The Emissions from Storage BREF [290, EC 2006] and Section 2.4.2 of this document report on the first three sources of diffuse emissions.

There are potential emissions of VOCs to air and of oils to water or land during loading, storage, unloading and the transfer of liquids and gases. VOCs can also be emitted to air from tank breathing and pipeline leaks. There are potential emissions of dust and metals to air and land from the loading and unloading operations, the transfer and storage of solid material and the resuspension of dust from the storage areas and conveyors. Suspended solids, metals, oil and various anions such as sulphate (depending on the ore and its treatment) can be emitted to water.

Process sources, reported in Section 2.4.3, are also important [219, VDI 2007]. since diffuse emissions may also occur from unsealed processes and during charging, smelting and tapping operations, as well as during the transfer of the molten products or intermediates from one operation to another. It is of particular importance that the prevailing temperatures of the various metal, slag or matte fractions are above the volatilisation points of the low-boiling accompanying metals (e.g. zinc) and oxides (e.g. SnO and PbO), so that the latter accumulate in the emitted vapours. As far as possible, diffuse emissions should be captured at the source via secondary hoods and the extracted off-gas should be routed to the gas-cleaning system.

Ventilation air with dust leaving through openings in the walls and roofs of buildings is also a source of diffuse emissions from a plant. When considering prevention measures, particular consideration should be given to employee conditions. Minimising diffuse emissions from a building by, for example, closing windows or otherwise containing them in the building is not a suitable approach because of considerations that need to be given to the exposure of the employees in the building. The collection of diffuse emissions in a building should therefore focus on preventing emissions at source (e.g. by measures such as a smoother feeding into the smelter, or improving the slag tapping hood, where feasible and appropriate). Workplace measurements and monitoring blood and urine levels in employees could also indicate the success of improved diffuse emissions capture [229, IZA plant data 2008]

2.4.2 Applied processes and techniques to prevent diffuse emissions from storage and handling of input materials

The main raw materials used in the production of non-ferrous metals are ores and concentrates, secondary raw materials, fuels (oil, gases and solid fuel) and process gases (such as oxygen, chlorine and inert gases). Other materials such as fluxes, additives and process chemicals (e.g. for abatement systems) are also used. This variety of materials possesses many handling and storage problems and the specific technique used depends on the physical and chemical properties of the material (see also the Emissions from Storage BREF [290, EC 2006]). In general, the storage of dusty material in open spaces should be avoided. Conveying systems should be equipped with enclosures. Fabric filters need to be examined and maintained regularly [307, Austria 2006]. The following applied processes and techniques can be used to prevent emissions to the environment.

2.4.2.1 Applied processes and techniques for ores and concentrates

Ores and concentrates may be delivered to the site by road, rail, barge or ship. Dust prevention techniques and dust collection and abatement systems are used extensively at the discharge points.

Process control is becoming more important for improving conversion efficiency, reducing energy consumption and reducing emissions, and is frequently based on effective sampling, analysis and recording of raw materials to establish optimum process operating conditions. This influences the choice of techniques for storage and handling.

The unloading, storage and distribution of solid material is carried out by similar techniques to those used for solid fuels. Usually, more stringent containment methods are adopted for these materials as they are generally more reactive, have a smaller particle size and are more easily

suspended in air or washed into water. Automatic quick-sealing devices are commonly used. Fluxing and slagging agents are also received on site and are handled in a similar manner to ores and concentrates.

Ores or concentrates (if they form dust) and other dusty materials are usually stored in enclosed buildings. Closed, covered stockpiles and silos are also used. Open stockpiles are used for large, lumpy material but are usually situated on a hard impervious surface, such as concrete, to prevent material losses, land contamination and contamination of the ore. Some large materials are not stored on a hard surface as damage can frequently occur and cause hidden problems. Bays are often used to segregate different grades of ore.

Ores and concentrates are normally used by large installations and therefore silos are not frequently used for primary storage but can be used for intermediate storage and the preparation of ore/flux blends. 'Loss-in-weight' dosing systems and belt weighers, etc. are used to meter ores and fluxes to achieve effective optimum blends and improved process control.

Water sprays are frequently used to suppress dust, but some operators require dry feed to the processes and are reticent about using water sprays. Alternative methods, such as using atomising sprays to give fine water mists, are used for dust suppression without over-wetting the material. Some concentrates naturally contain sufficient water to prevent dust formation.

Sealing agents (such as molasses, lime or polyvinyl acetate) can be used to prevent dust formation in windy conditions. Sealing can prevent the oxidation of surface layers and the subsequent leaching of material to ground or surface waters.

Unloading of minerals may be a potential source of significant dust emissions. The main problem occurs when a rail car or other tipping vehicle discharges by gravity. The rate of discharge is not controlled and results in a high volume of displaced air and dust, which can overwhelm dust extraction systems. Enclosed delivery halls using an automatic door closure are used.

Transparent plastic screens which seal against the tipping car are used. In this case, displaced air is passed to a sprung section and surge container to absorb the energy of the discharge; the increase in air volume is damped, allowing the extraction system to cope.

Material can be reclaimed by an underfeed conveyor, grab crane or a front-end loader, with totally enclosed conveyors used to transport dusty material. Transfer by pneumatic, dense phase systems are also used. For dusty materials extraction, filter systems may be used to deal with dust from static offloading points and conveyor transfer points. In the case of using open conveyors, dust can be produced if the belt is running too fast (i.e. more than 3.5 m/s). When a front-end loader is used, dust can be generated during the whole transporting distance.

Solids may adhere to wheels and other parts of vehicles and will contaminate roadways both on and off site, and the use of wheel and under-body washes (or other cleaning techniques if freezing temperatures are encountered) to decontaminate vehicles is frequently employed. The use of front-end loaders that are bigger than necessary can aggravate this problem.

Road sweepers or other specialised equipment using a combination of water jets and vacuum collection are commonly used to remove deposited dust, including that from old storage areas, to keep internal roads clean and prevent resuspension of the dusts.

Depending on the local topography, precautions against flooding and the consequent emissions of toxic materials need to be taken.

2.4.2.2 Applied processes and techniques for secondary raw materials

This industry is particularly active in recovering metal from a variety of sources and consequently uses a wide range of secondary raw materials. Scrap metal, skimmings/dross and flue or filter dust are used as sources of non-ferrous metals and these materials contain a number of metals or metal compounds. An integrated approach within an installation or between a group of companies in close proximity can encourage the use of secondary raw materials [277, Heino 2004]. Secondary raw materials are also used in some primary processes.

The source of the secondary raw material may give information on the potential emissions due to the presence of acids, oils, organic contaminants (that can produce PCDD/F during melting processes), anions and components such as ammonia from the reaction of skimmings/dross with moisture. This directly influences the potential emissions to air, water and land, and any of the components of these materials can be emitted. Materials are checked (e.g. by inspection and sorting) for unforeseen impurities and contamination, and this can be cost-effective for maintaining a cleaner product and reducing emissions.

The physical state of the material also affects the storage and handling methods. These materials can be dusty or oily and range in size from fine dusts to entire components. These factors affect the delivery, handling and storage methods used. The techniques used for primary raw materials are used together with those given below.

Secondary raw materials can be delivered to the site as loose material, in big bags or in drums. The physical state of the material dictates the delivery method and the storage method used. The source of the material also has a significant impact, and there are several methods available for grading material. Quality control and analysis of the feed material is practised in most cases.

Large components and material such as swarf or grindings are stored on concrete areas that may be in the open, covered or inside buildings. Some large materials though are not stored on a hard surface if damage to the surface can occur. The material is usually stored in segregated piles to keep different grades and alloy compositions separate.

Dusty materials and skimmings/dross are also stored in segregated piles, which may be in the open, covered, or inside buildings. These materials can be pyrophoric or may react with moisture to form ammonia or other gases such as arsane or stibane, depending on the composition. The storage method applied therefore takes these factors into account. Cold dusty material can be coated with material such as molasses to form a dry crumb, which is not dust-forming. The coating material does not affect pyrometallurgical processes.

Secondary raw materials may be contaminated with a variety of other materials such as oils, acids and organic matter, which could be washed into drainage systems. The potential contamination of rainwater and other water by such contaminants is taken into account in the design of storage methods and the treatment of run-off water from these areas. Bunded areas, sealed floors and oil interceptors are used to prevent emissions to water.

Materials are handled by a variety of methods depending on the storage. Grabs, conveyors and shovels are used. Secondary materials frequently need to be blended prior to processing or pretreatment, and intermediate storage is then used.

2.4.2.3 Applied processes and techniques for fuels

The fuel may be used directly as a heat source, as a reducing agent or both. This should be identified for each installation. Fuels may be delivered to the site by pipeline, road, rail or ship. The methods used for delivery are outside the scope of this document, but the use of road transport for frequent deliveries can give rise to noise and congestion at the site or its locality.

The delivery and storage of fuel is usually controlled by the operator to prevent spillage and leaks, and the techniques used include the following:

Liquid fuels

- Road and rail tankers are most commonly used for delivery. Site storage systems feature the use of vented or floating roof storage tanks, which are sited in sealed areas or bunds with sufficient capacity to contain the contents of the largest storage tank (or 10 % of the total volume of individual tanks if that is greater). Efficient oil interceptors are used to prevent the discharge of oil in site run-off water.
- The venting of gases from the storage tank back into the delivery tank is frequently practised unless floating roof storage tanks are used. Automatic resealing of connecting hoses is used when liquids and liquefied gases are delivered. Delivery connections are sited inside the bund.
- Regular checks of the tank contents to identify leaks and the safe volume for receipt is common practice. Alarms are used. Occasionally inert atmospheres are used.
- Pipelines may also be used for liquid fuel delivery and may incorporate intermediate tank storage. Fuel distribution from the site storage tanks to the process is usually by overhead pipeline, by service trenches, or less commonly by buried pipeline. Barriers are used to protect overhead pipelines against damage. The use of underground pipes could hinder the prompt identification of fuel leaks, which could cause contamination of the ground and subsurface water.
- If there is a risk of groundwater contamination, the storage area should be impermeable and resistant to the material stored.

Gaseous fuels

- Pipelines are the most common delivery system for gaseous fuels. Although liquid petroleum gases (LPG) can be classified as a liquid, the same techniques as for gases are used.
- Some pyrometallurgical processes (i.e. the carbothermic production of ferro-alloys in closed submerged electric arc furnaces) produce a carbon-monoxide-rich exhaust gas as a by-product. The amount of CO varies a great deal, depending on the metal and the production process. The exhaust gas can contain CO, from lower amounts (low CV gas) up to 90 % (high CV gas). The gas is cleaned in a cascade wet scrubber and then distributed throughout the site as a secondary fuel, or sold to neighbouring mills. Excess gas may be used for the production of electricity or flared off.
- The delivery of gases is often associated with pressure reduction equipment or, occasionally, compression equipment. In all cases, the use of pressure and volume monitoring is frequently practised to identify leaks, and gas monitors are sometimes used to monitor the workplace and in the vicinity of storage tanks.
- Distribution by overhead pipeline or pipelines in service trenches is common and damage protection methods are adopted.

Solid fuels

- Road, rail or ship deliveries are used for solid fuel transport. Storage in silos, closed stockpiles, open stockpiles and in buildings are used depending on the type of fuel (e.g. coke, coal) and its tendency to form dust.
- Open stockpiles are not frequently used, but those that do exist are designed to give an even, sloping face to the wind and can have retaining walls to reduce the effect of wind and to contain the material. Material can be reclaimed using an underfeed conveyor, a grab crane or a front-end loader.
- Conveyor systems are designed with a minimum number of direction changes and minimum drop height at these changes to reduce spillage and dust formation. Closed, covered or open conveyors are used depending on the potential for dust formation;

extraction and dust filtration is used if needed. In the case of open conveyors, dust can be produced if the belt is running too quickly (i.e. more than 3.5 m/s). Belt scrapers are used to clean the return section of the belt to prevent spillage.

- The moisture content of the fuel can be controlled to prevent the release of dust. Dust explosions are possible with dry and fine material. A contract specification for the fuel and the acceptable fines content can help to reduce the impact [243, France 2008].
- Some open stockpiles are treated with water sprays or sealing agents (such as polyvinyl acetate or molasses) to prevent dust formation in windy conditions and surface oxidation of the fuel. Solid matter can be washed into drainage systems and efficient settlement is often used to prevent emissions to water from open stockpiles.
- Solid fuel can be distributed on site by truck, conveyor or by pneumatic systems. Day storage or surge storage, usually in silos or hoppers, is used frequently. These systems usually incorporate dust extraction and filtration equipment.

2.4.2.4 Applied processes and techniques for process chemicals and gases

Acids and alkalis and other chemical reagents are often used in the main process and in abatement equipment, and may be produced during the process. They may be used to leach metals, precipitate compounds or can be used for off-gas or effluent treatment processes. Chemical compounds may be produced as part of the main process.

The supplier generally specifies the appropriate storage of these materials. Many of these reagents can react together and the storage and handling methods usually take this into account by segregating reactive materials. Liquids are usually stored in drums or tanks in open or enclosed banded areas; acid- or chemical-resistant coatings are used. Solids are generally stored in drums or bags (big bags) internally with isolated drainage systems; silos are used for some materials such as lime. Pneumatic transport systems are used.

Gases are used for a variety of purposes in the production of non-ferrous metals. The industry can use large quantities of process gases. The consumption of particular gases influences the method used for transport and distribution.

Oxygen is used to improve combustion, provide oxidation and improve conversion processes and natural gas; butane or propane is used to reduce metal oxides. Carbon dioxide, nitrogen and argon are used to provide inert atmospheres and to degas molten metal. Chlorine is used in the chlorination step of electrolytic magnesium production to degas molten metal and to remove unwanted metallic components (e.g. magnesium) from aluminium and in the Boliden-Norzink process. Carbon monoxide and hydrogen are used in the main processes. Hydrogen and sulphur dioxide are used to reduce oxides and salts. Chlorine and oxygen are used in leaching processes and chlorine is also used in the Boliden-Norzink process. Specific applications are discussed under individual metal production processes in Chapters 3 to 9.

The operator can produce gases on site, although contract gas production is encountered and these installations also supply other sites. Several sites use oxygen to improve combustion, and nitrogen for the spark suppression of pyrophoric materials. The same cryogenic or pressure swing process produces both gases, and the low-grade nitrogen produced can be suitable for some inerting operations. In a similar way, combustion gases which have a low oxygen content can be used to prevent autoignition.

Gases can be transported by tanker and pipelines. Chlorine is usually stored as a liquid in drums or tanks and is distributed by evaporation and a suction line, therefore gas leakage is prevented. Inventory and pressure control and monitoring can provide leakage detection for all gases.

Flow balancing and pressure decanting are used for the mixing of gases (e.g. argon/chlorine mixtures). For small volumes, premixed gases can be supplied.

The distribution of gases within the site is normally achieved by pipelines, which are sited overhead using good damage protection systems. Health and safety regulations govern the use and distribution of chlorine.

2.4.3 Applied processes and techniques to prevent diffuse emissions and collect off-gases from metal production processes

This section deals with the prevention of diffuse emissions and the collection of off-gases from metal production processes, including diffuse emissions caused by poorly designed or inadequately maintained gas collection systems. Gases and fumes that escape from the processes are released into the working area and then escape into the surrounding environment. They therefore affect operator health and safety, as well as contributing to the environmental impact of the process. Process gas collection techniques are used to prevent and minimise these diffuse emissions.

Dust, fumes and gases from metal production processes are collected using enclosed furnace systems, by total or partial enclosure of launders, furnace tapping systems, transfer points and other handling systems or by hooding [73, Theodore, L. et al. 1992]. Hot gases from launders can be collected and transferred as combustion air, so that the heat content is also recovered. Sealed furnaces can be charged from sealed lance or burner systems, through hollow electrodes, through hoods or tuyères, or by docking systems that seal onto the furnace during charging. Hoods are designed to be as close as possible to the source emissions while still leaving room for process operations. Movable hoods are used in some applications, and some processes use hoods to collect primary and secondary fumes. Separate tertiary collection systems designed to collect all remaining emissions are also used; they are often called 'house-in-house' or 'doghouse' systems (Figure 2.2).

Besides the aforementioned techniques, the following measures to prevent diffuse emissions and collect off-gases from metal production processes have also been reported.

- Increasing the burden of the furnace or cell to provide a better seal and to improve the collection of off-gas.
- Renewal or optimisation of off-gas collection and filter units.
- Reduction of furnace downtime by improving the refractory lining (thereby reducing start-up and shutdown times, which cause higher emissions for a limited time).
- Closing the roofs of the process buildings and modernisation of the filters.
- Using computerised fluid dynamics (CFD) studies and tracers to model the flow of furnace gases and also the movement of fused electrolytes [233, COM 2008] so that diffuse emissions can be prevented or minimised. The use of these techniques has resulted in optimised gas collection systems. Modifications to furnaces or electrolyte charging systems to give small, even additions of raw materials have been developed in parallel and also contribute to the prevention of diffuse emissions [233, COM 2008].
- Design criteria. Collector systems and extraction rates are designed on the basis of good information about the characteristics of the material to be collected (size, concentration, etc.), the shape of the dust cloud at the extremes of operation, and the effects of volume, temperature and pressure changes on the system. Computational fluid dynamic studies can be used to achieve optimum design and extraction efficiencies [226, Nordic Report 2008]. Correct measurement or estimation of the gas volume, temperature and pressure are made to ensure that sufficient rates of extraction are maintained during peak gas flows. Some of the characteristics of the gas and dust are also critical to good design to avoid problems of abrasion, deposition, corrosion or condensation and these are measured. Another significant factor is the provision of access to furnace filling or tapping areas while maintaining good rates of collection; operator experience is used at the design stage to provide this.

- Other techniques are available to collect the diffuse emissions that are not preventable or contained [73, Theodore, L. et al. 1992], [77, Soud, H.N. 1995], [74, Startin, A. 1998], [76, Soud, H.N. 1993].
- Closing and decontamination of old storage or disposal areas.

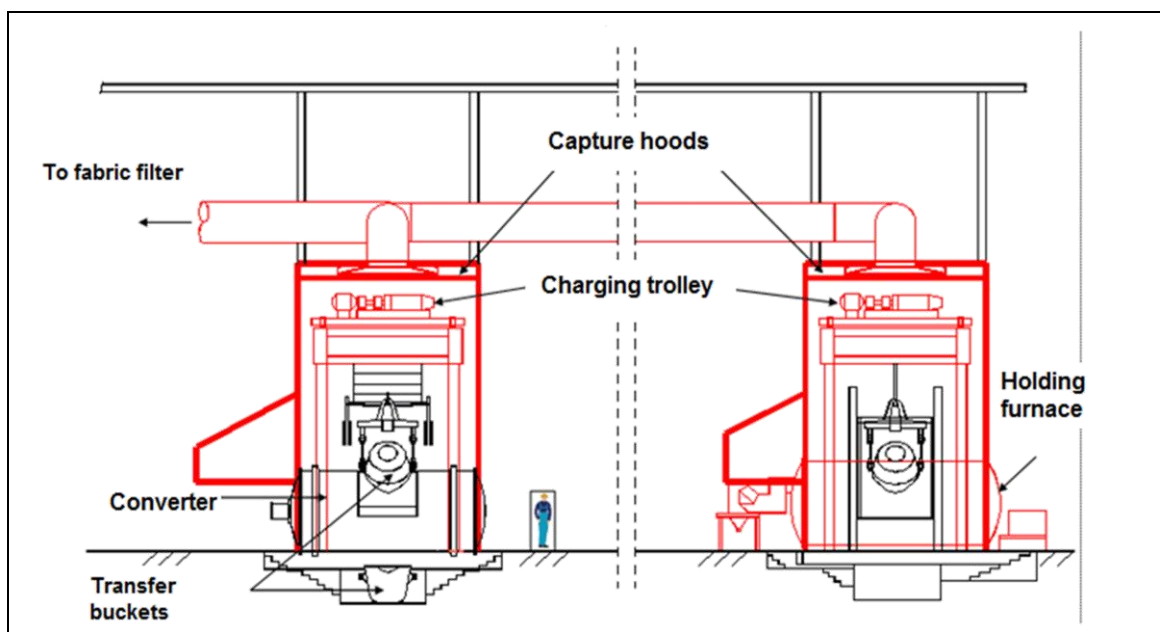

Figure 2.2: House-in-house collection system

The application of design criteria for the collector and extraction systems is useful not only for preventing emissions to air but also for reducing energy consumption, since gas collection requires the movement of significant volumes of air, and this can consume vast amounts of electrical power. Modern systems focus the design on capture systems to increase the rate of capture and to minimise the volume of air that is moved [121, Rentz, O. et al. 1999]. The design of the collection or hood system is very important as this factor can maintain capture efficiency without excessive power consumption in the remainder of the system. Sealed systems such as sealed furnaces can allow a very high capture efficiency to be attained and have an advantage over semi-sealed furnaces. Batch processes such as converters have widely varying gas flow rates and are also difficult to seal and often secondary hoods are needed [243, France 2008].

Ducts and fans are used to convey the collected gases to abatement or treatment processes. The effectiveness of collection depends on the efficiency of the hoods, the integrity of the ducts and on the use of a good pressure/flow control system. Variable speed fans are used to provide extraction rates that are suitable for changing conditions such as gas volume, with minimum energy consumption. It is also possible to use an intelligent system to operate the fans automatically when process stages that produce fumes are operated, as in the aforementioned house-in-house system. The systems can also be designed to take account of the characteristics of the plant that it is associated with, e.g. the abatement plant or sulphuric acid plant. Good design and maintenance of the systems is practised.

2.5 Raw material management

Ores, concentrates and secondary raw materials are sometimes in a form that cannot be used directly in the main process. Drying/thawing may be needed for control or safety reasons. The material size may need to be increased or decreased to promote reactions or reduce oxidation. Reducing agents such as coal or coke and fluxes or other slag-forming materials may need to be added to control metallurgical process. Fluxes are added to optimise the recovery of the target metal and to separate impurities.

Coatings may need to be removed to avoid process abatement problems and improve melting rates. All of these techniques are used to produce a more controllable and reliable feed for the main process and are also used in precious metals recovery to assay the raw material so that toll recovery charges can be calculated.

2.5.1 Applied processes and techniques

2.5.1.1 Thawing

Thawing is performed to allow frozen material to be handled. This occurs, for instance, when ores or concentrates or solid fossil fuels such as coal are discharged from a train or ship in the wintertime. Thawing can be achieved by using steam jets in order to just melt the ice to enable unloading of the raw material.

2.5.1.2 Drying

Drying processes are used to produce a raw material that is suitable for the main production process. Rotary, steam coil and other indirect dryers are used and their economics, availability, reliability and source of energy used need to be taken into consideration.

The presence of water is often avoided, for several reasons.

- It is dangerous when large volumes of steam are produced rapidly in a very hot furnace as this could result in an explosion.
- Water can produce a variable heat demand in a concentrate burner, which upsets the process control and can inhibit autothermal operation.
- Separate drying at low temperatures reduces the energy requirements. This is due to the energy required to superheat the steam within a smelter and the significant increase in the overall smelter flue-gas volume, which increases the fan duty.
- Corrosion of plant and pipework, etc. can be caused.
- Water vapour may react with carbon to form H_2 and CO .
- Large volumes of steam can cause diffuse emissions, as the process gas offtake capacity may be insufficient to handle them.

Drying is usually achieved by the application of direct heat from a burner or by steam jets, or indirectly using steam or hot air in heat exchanger coils. The heat generated from pyrometallurgical processes, e.g. anode furnaces, is also often used for this purpose, as well as the CO -rich exhaust gas that can be burnt to dry the raw material. Rotary kilns and fluidised bed dryers are used. The dried material is usually very dusty and extraction and abatement systems are used to collect dusty gases. Collected dusts are returned to the process. Dried ores and concentrates can also be pyrophoric and the design of the abatement system usually takes this into account. Nitrogen blanketing (sometimes as a by-product from oxygen production) or the low residual oxygen in combustion gases can be used to suppress ignition. Dryer off-gases may contain SO_2 , and treatment of the gases may thus be considered.

2.5.1.3 Crushing, size reduction and screening

Crushing, size reduction and screening are practised to reduce the size of products, residues or raw material so that they are suitable for sale or further processing. Many types of crusher are used including cone crushers and ball crushers. Wet or dry materials are crushed, and a blending stage can be included. The specific equipment used will depend on the raw materials to be treated. Dry crushing is potentially a major source of dust emissions and extraction and abatement systems are used, with the collected dusts usually returned to the process. Damp materials can be crushed where dust formation can cause problems and where wet pelletising stages follow.

Granulation is used to produce small particles of slag, which are suitable as shot blasting material, road fill or a material that can be reprocessed to recover the metal content. Molten slag is cast into a water bath or poured through a stream of water. Granulation is also used to produce metal shot. Granulation processes have the potential to form fine dust and aerosols, which should be controlled.

Electronic components are a source of several non-ferrous metals and these may be ground in shredders or mills to liberate the circuit boards and other material from the metallic components, so that separation can take place.

2.5.1.4 Battery breaking

Battery breaking is used to recover lead, nickel, cadmium and other materials from batteries. For lead-acid batteries, hammer mills are used to break the battery cases to liberate lead (as grids) and lead compounds (as paste) and allow the recovery of the plastic case material (mainly polypropylene). The electrolyte is also removed and treated or used. Two-stage crushing can be used to control the particle size and prevent the lead oxide from being impacted into the plastic during a single stage mill. Plastic material is separated and washed to improve the quality and to produce plastic that is suitable for recycling. The acid content of the batteries can contaminate land and water if it is not collected and handled properly. Sealed acid-resistant drainage systems can be used with dedicated collection and storage tanks. The milling stages can produce an acid mist, and this can be collected in wet scrubbers or mist filters.

Nickel-cadmium batteries are pyrolysed to remove any plastic coating and to open the batteries. Pyrolysis is carried out at low temperatures and the gases are treated in an afterburner and then a fabric filter. Cadmium and nickel are recovered from the electrodes, and steel from the casing material.

2.5.1.5 Blending

Blending is performed to mix ores or concentrates of varying quality and to combine fluxes or reducing agents with the ore to produce a stable feed to the main process. Blending can be achieved in proprietary blending equipment, in the grinding stage, or during the conveying, drying and storage stages. Accurate blends are produced using bedding plants, loss-in-weight dosing systems, belt weighers or by volume from the loading equipment. Blending can be a very dusty operation and high levels of containment, extraction and dedusting are used. Collected dusts are returned to the process. Wet mixing is also used to avoid the production of dusts; slurry is produced that is then dewatered and used in a pelletising process. Coating and binding agents may also be used for this purpose. Depending on the process, it may be necessary to pelletise the blended material before further processing such as sintering.

2.5.1.6 Briquetting, pelletising and other agglomeration methods

Many techniques are used to treat concentrates, flue-dusts and other secondary material and they include the baling of wire or small scrap, compressing briquettes of material as mentioned before and extruding or rolling pastes to produce even-sized balls of material. Coating and binding agents are used for this purpose to reduce dust development in subsequent process steps.

Briquettes and pellets which contain a mixture of fine ore or concentrate, recycled dust and additional material such as reducing agents are often produced to ensure efficient smelting conditions. After adding binders or water, the mixture is fed into a press to produce a pillow-shaped briquette or into a rotary pelletising drum, pelletising disc or mixing machine to produce pellets. The binding material should have such properties that the briquettes have sufficient green strength to enable them to be handled easily and to remain unbroken when they are charged to the furnace. Various types of binders can be used, such as black liquor (from the paper pulping industry), molasses and lime, sodium silicate, steel slag or cement, and they also reduce dust formation. Pitch can be added to improve the green strength. Coarse fractions of filter dust from the furnace bag filter and filter dust from crushing and screening operations can be mixed with the other materials to be briquetted.

2.5.1.7 Sintering and calcination

These processes are used to increase the size of the raw material or the chemical composition so that it is suitable for further processing. Agglomeration and sintering allow a more even gas flow through a furnace bed and reduce dust formation, gas volume and diffuse emissions [[106](#), [Raffinot, P. 1993](#)].

Sintering and calcining are also used for this purpose and additionally are used to adjust the chemical form of the mix or to convert any sulphur present, e.g. the calcination of dolomite into dolime in the production of magnesium. The main binding mechanism in ore sintering is achieved by bringing the ore up to a temperature where the gangue minerals start to melt, whereby individual particles are fused together in a matrix of molten slag. In some cases, the formation of new crystals across former grain boundaries will play some role in the sintering process. The sinter is usually crushed and classified and the fine materials are returned to the sintering process. Sometimes the returned material is two to four times larger than the sinter produced. The feed particles are then sent to the smelter.

The sintering and roasting of sulphidic ores are often carried out together at high temperatures and in this case the gases produced are high in sulphur dioxide. The oxidation of sulphur provides the heat necessary for the process. Generally, the ore is blended with returned sinter and fluxing agents and may be pelletised before sintering. In the case of oxides, such as secondary raw materials, coke is also added.

Sinter plants use a moving grate, continuous grate or a steel belt to carry the material through heating and cooling zones; some plants use steel pallets to contain the feed. The gases are drawn upwards or downwards through the bed (updraught or downdraught sintering). A sintering machine that uses a combination of updraught and downdraught stages is also used and is capable of minimising gas volumes and diffuse emissions and recovers heat efficiently. Sometimes a layer of sintered material is used between the grate, and the blend is used to protect the steel grate.

The sintering of sulphidic ores is exothermic, though other materials use natural gas as a fuel. The hot gases are usually recycled to preheat the bed or the combustion air. The sinter is cooled by an air draught on the bed or in a water quench. The sinter is then sieved and sometimes crushed to produce a final feed material of a uniform size. The fine materials are returned to the sintering process.

Calcining is performed in rotary, fluidised bed or multiple hearth furnaces, and there is normally no addition of carbon during the process. The calcination of sulphidic concentrates performs the roasting stage and is discussed in Chapters 3 to 9 for metal production.

2.5.1.8 Fuming processes

These processes are used to fume volatile metals such as lead or zinc from a substrate. The processes use high temperatures and a source of carbon to produce an inert slag by fuming or volatilising metals from the material. This allows the metals to be recovered, usually as an oxide, for further processing. Waelz kilns, Herreshoff and slag fuming furnaces are used. Fuming is also achieved during batch converting processes when volatile metals are removed during the process.

2.5.1.9 Decoating and de-oiling

Decoating and de-oiling operations are usually performed on secondary raw materials to reduce the organic content of the feed to some main processes. Washing and pyrolysis processes are used. Centrifuging can recover oil and reduce the load of the thermal system. Major variations in organic content can cause inefficient combustion in some furnaces and produce high volumes of combustion gases that contain residual organic compounds. The presence of coatings can also reduce the melting rate significantly [122, ETSU 1994], [118, Laheye, R. et al. 1998]. These events can cause significant emissions of smoke, PCDD/F and metal dusts to air unless the gas collection and combustion systems are sufficiently robust. Sparks or burning particles can be produced and can cause significant damage to abatement equipment. The in-furnace decoating of contaminated scrap is also less efficient in most cases than decoating shredded material in a separate kiln, due to the production of more dross [122, ETSU 1994], but some furnaces are especially designed to receive organic contaminants.

The removal of oil and some coatings is achieved in a specially designed furnace such as a swarf dryer. In most cases, a rotary furnace is used at a low temperature to volatilise oil and water. Direct and indirect heating of the material is used. An afterburner operated at a high temperature (more than 850 °C) is used to destroy the organic products produced in the furnace, and the gases are usually filtered in a fabric filter.

Mechanical stripping is also used frequently to remove insulation from cables and coatings from other materials. Some processes use cryogenic techniques to make the coating brittle and therefore easier to remove. Washing with solvents (sometimes chlorinated) or with detergents can also be used. Solvent vapour systems with integral condensers are the most common. These processes are also used to degrease production items. Treatment systems to prevent water contamination are used in these cases.

2.5.1.10 Incineration and pyrolysis

Incineration and pyrolysis processes are normally used to treat photographic film, sweepings, catalysts and other materials to concentrate the precious metals content or to recover nickel. They are also used to pretreat catalysts to remove the organic content before further treatment. These processes are usually carried out at low temperatures to prevent the carryover of the metals. The gases produced from the incinerator are then treated in an afterburner and fabric filter. The potential formation of PCDD/F should be noted for these processes.

Simple box kilns and rotary furnaces are used for the incineration or pyrolysis stage. Raw materials are fed into the box kilns in trays. The metal-rich ashes are collected or quenched before they are processed further.

2.5.1.11 Leaching and washing procedures

Leaching or washing procedures are used to concentrate metal from ores or concentrates in a liquid phase. Washing is used to remove impurities such as alkali and alkaline earth compounds from some concentrates and secondary raw materials before further processing. Washing is also used to reduce the content of cadmium, chloride and sulphate, etc. in residues to meet the processes' requirements or to recover them.

Examples of leaching and washing procedures are given below:

- Waelz oxide can be washed to produce material that is suitable for use in a primary process;
- cadmium in filter dust can be removed before the dust is recycled to a smelter;
- secondary lead materials are leached to remove chlorides, alkalis and zinc before resmelting.

Leaching is also used to remove metals from complex matrices or to concentrate the precious metals that are used to coat catalysts. Ores such as quartz are washed and screened before use. Open or closed circuit washing processes are used and a bleed of liquor is used in a closed circuit system. Waste water is treated before discharge.

2.5.1.12 Separation techniques

These processes are used to remove impurities from raw materials prior to their use.

In non-ferrous metals plants, separation techniques are more frequently used for secondary raw materials and the most common is magnetic separation to remove items of iron. Manual and mechanical separation techniques are used to pretreat waste streams, such as the removal of batteries, mercury contacts, etc. from electronic equipment according to the WEEE Directive, or the separation of the car catalyst from the steel casing. The separation makes it possible to recover more metals in dedicated processes. Heavy media and relative density separation (sink/swim) is used by the scrap processing industry but may be encountered in the non-ferrous metals industry, for example in the processing of battery scrap to remove plastic material. In this case, the density and size difference of the various fractions is used to separate metal, metal oxides and plastic components using a water carrier. Air classification is also used to separate metals from less dense materials, such as the plastic and fibres from electronic scrap. Flotation is also used to enrich leach residues and is used in the copper sector to recover copper from furnace slag. The use of water pulses, called jigging, is used for solids separation [243, France 2008].

Magnetic separation is used to remove pieces of iron to reduce the contamination of alloys. Generally, overband magnets are used above conveyors. Sloping hearths in a reverberatory furnace are used to melt zinc, lead and aluminium to leave higher melting point impurities (e.g. iron) on the hearth for further processing.

Moving electromagnetic fields (eddy current separation) are used to separate aluminium from other material. A variation on this technique uses this moving electromagnetic field to pump molten aluminium or other metals, without there being a direct contact between the metal and mechanical components.

Other separation techniques involve the use of colour, UV, IR, X-ray, laser and other detection systems in combination with mechanical or pneumatic sorters. These are used, for example, to separate nickel-cadmium batteries from other battery types, though the techniques are still being further developed for other applications.

2.5.1.13 Transfer and charging systems

These systems are used to convey the raw materials between pretreatment stages and then into the main process. Techniques similar to those used for raw materials are used and similar problems of dust production, containment and extraction exist. Pneumatic, dense air and air slide systems are also used and can even out variations in feed quality. Collected material is reused.

Pretreated materials may be drier than raw materials, and more stringent methods are used to prevent dust emissions. Water spray systems are generally not used but high standards of housekeeping are needed. Conveyors for the transport of dust-forming materials are generally enclosed and, in these cases, efficient extraction and abatement systems are employed at exposed, sensitive areas such as conveyor change points. An alternative is the use of fine water sprays or mists. Bottom scrapers are used on conveyors to prevent the carryover of material on the return section of the belt. Dense phase, pneumatic conveying systems are also used frequently.

Some materials arrive in drums, big bags or other packaging. If the material is dusty, the emptying of these containers should be done in dust-capturing systems, e.g. sealed devices under aspiration, under sprinkling, or in enclosed buildings. In some cases, mixing these materials with water or with wet raw materials is appropriate depending on the material as long as no reactions can occur. In other cases, handling them separately in closed systems is preferable.

2.6 Metal production processes

There are several processes or combinations of processes used to produce and melt metals. These processes are mostly metal-specific, and therefore they are described in depth in the corresponding metal-specific chapters. Nevertheless, a general overview of pyrometallurgical and hydrometallurgical processes and a combination of both can be found in Annex 13.1.

Controlled emissions from metal production processes have known sources and can be captured and treated.

The techniques used to remove dust, gaseous compounds (such as NH_3 , SO_2 , SO_3 , HF, HCl and NO_x), dioxins, sulphur dioxide and mercury are described in Section 2.12.5. Dust and acid gases are commonly removed and valuable or toxic metal components are recovered for use in other processes. The design of the abatement process is critical, and factors such as efficiency, suitability of the method, and the input and output loading of the material to be collected are used.

2.7 Sulphur dioxide

Sulphur dioxide is produced during the drying and smelting of sulphidic concentrates and other material. Calcining, smelting, converting and other operations produce sulphur dioxide at varying concentrations and the removal systems used depend on the concentration encountered.

Sulphur that is present in raw materials can be incorporated into slags or mattes using appropriate reagents, and the mattes can be used in the processes. Sulphur that is not captured in the matte or slag from a smelting process is usually present as SO_2 and can be recovered as elemental sulphur, liquid SO_2 , gypsum or sulphuric acid. The presence of markets for these products influences the choice of the end-product but the most environmentally safe option is to produce gypsum or elemental sulphur in the absence of reliable outlets for the other products. Sulphur dioxide is produced from the roasting and smelting of sulphidic concentrates and the associated conversion processes. These processes are operated so that the maximum concentration of sulphur dioxide is produced to improve the efficiency of sulphur recovery. The recovery of sulphur eliminates cross-media issues.

2.7.1 Applied processes and techniques

A distinction can be made between techniques applied to reduce SO_2 emissions from off-gases with less than 1 % SO_2 and for gases with a higher SO_2 content.

Techniques for off-gases with up to 1 % sulphur dioxide

1. Lime injection followed by a fabric filter.
2. Reaction of weak gases with sodium sulphite and water to produce sodium bisulphite. Concentrated sulphur dioxide can be stripped from this solution, and liquid sulphur dioxide produced or other products such as sulphur (Wellman-Lord regenerable process).
3. Scrubbing with an amine or polyether-based solvent which can absorb sulphur dioxide, which is then desorbed and sent as a side-stream to a sulphuric acid plant or removed by reaction with water to produce sulphuric acid or liquid sulphur dioxide.
4. Oxidation with hydrogen peroxide to produce sulphuric acid.
5. Oxidation with an activated carbon catalyst to produce sulphuric acid.
6. Flue-gas desulphurisation (FGD) in a dry or semi-dry scrubber using lime, NaHCO_3 or wet limestone to produce gypsum or other desulphurisation products. This technique is used extensively in power plants.
7. Double alkaline scrubbing with caustic soda absorption and gypsum precipitation.
8. Scrubbing with seawater.
9. Alumina absorption and gypsum precipitation (Dowa process).
10. Scrubber with $\text{Mg}(\text{OH})_2$ and the crystallisation of magnesium sulphate.
11. Wet or dry scrubbing with zinc oxide to produce zinc sulphite or sulphate which can be treated in a zinc leaching stage.

Techniques for off-gases with a high SO_2 content (> 1 %)

Sulphur dioxide is produced at higher concentrations during the sintering, roasting and smelting of a wide range of sulphidic ores and concentrates. The metals produced are copper, nickel, lead, zinc, molybdenum and several mixed metal streams. The techniques used to treat these off-gases are listed below.

1. Absorption of sulphur dioxide in cold water (e.g. cold seawater) followed by vacuum stripping and recovery as liquid sulphur dioxide. This process is used in conjunction with a sulphuric acid plant to recover sulphur dioxide that is not dissolved. The potential for the production of liquid sulphur dioxide depends on the existence of a local market.
2. Production of sulphuric acid. The production of sulphuric acid by burning sulphur to produce sulphur dioxide is a well-established chemical process. These installations

benefit from a constant, high concentration of the gas and therefore have fewer process limitations. Gases from a roaster or smelter do not have these characteristics and are more difficult to operate and may not achieve the same level or consistency of conversion.

The smelter gases from the furnace are cleaned and cooled and may be dried, as shown in Figure 2.3 (see also Section 4.4.11 of the LVIC-AAF BREF). The sulphur dioxide in the gas is then converted to sulphur trioxide in a contact process when the gases are passed through a vanadium pentoxide catalyst bed. Sometimes the catalyst is doped with caesium oxide, which improves performance particularly when the SO₂ concentration is low and variable or when the temperature is low. The plant design should allow operation at lower temperatures (depending on the heat exchange performance). See Section 4.4.4 of the LVIC-AAF BREF. Improved catalysts are used to increase the conversion efficiency in single and double contact/double absorption plants [339, COM 2007].

In a **single contact plant**, the gases pass through a series of three or more catalyst beds to obtain a high conversion efficiency. The production of sulphur trioxide is exothermic and if the sulphur dioxide content is high enough to generate sufficient heat, the gases are cooled between each pass. With gases that have a low sulphur dioxide content, heat may have to be added before the passes. The sulphur trioxide formed is then absorbed in 98 % sulphuric acid, which is then diluted to give sulphuric acid.

The wet sulphuric acid (WSA) process is based on condensation of the acid (and not on absorption), which is especially suitable for gases containing 1–4 % SO₂. It can achieve up to 99 % conversion.

The presence of sulphur trioxide inhibits the conversion of sulphur dioxide and a **double contact/double absorption process** is therefore most commonly used to achieve more efficient sulphur dioxide conversion when the sulphur dioxide content of the gas is sufficiently high. In this case, sulphur trioxide is absorbed into 98 % sulphuric acid after the second or third pass, allowing conversion of more sulphur dioxide in the subsequent passes. This is followed by a further sulphur trioxide absorption stage. The use of a double contact/double absorption plant increases the removal efficiency of sulphur dioxide from 98 % to > 99.7 % [130, Eurometaux 1998]. It has also been reported that if the plant design allows operation at a lower temperature (depending on the heat exchanger performance) the use of a caesium-doped catalyst can improve this to greater than 99.9 % [137, Riekkola-Vanhanen, M. 1999]. A conversion rate of up to 99.97 % was observed under very special conditions [240, Nyrstar Budel 2008]. Catalysts decrease in effectiveness as they age and the effect can lead to a 0.1 % reduction in conversion over a three-year operating period [339, COM 2007]. The double contact/double absorption plant is shown in Figure 2.4.

Conversion to double contact/double absorption is complex and expensive but it is possible to use a single contact plant with tail gas desulphurisation to achieve lower residual SO₂ concentrations. Gypsum can be produced for external sale or alternatively zinc sulphite (or sulphate) can be produced which can be used in the zinc leaching stage. These options can allow energy savings and lower waste generation but the cost must be compared to conversion under local conditions. If there is no market for gypsum, the costs for landfilling gypsum need to be considered.

Dust removal before the contact process is essential to protect the catalyst and to produce a pure acid. This reduces the concentration of most metals, for example zinc, to acceptable levels in the acid that is produced and prevents the poisoning of the catalyst. The pretreatment of the gas stream usually involves several stages depending on the contaminants present in the gas stream. The stages can include cooling with heat recovery, a hot electrostatic precipitator, scrubbing to remove mercury, etc. and a wet electrostatic precipitator. The weak acid generated in the gas-cleaning section typically contains 1–50 % H₂SO₄. Halides will also be present as HCl (10–5000 ppm) and HF (10–1000 ppm including H₂SiF₆). In the Polish plant Głogów 2, there is a high level of fluoride in the gas entering the cooling and washing scrubber (500–2000 ppm). A

system is used to remove fluoride from the gas stream by dosing a solution of sodium silicate into the scrubber circuits. The acid may also contain metals such as copper, zinc and iron (individually up to 2500 ppm), mercury (up to 1900 ppm) and lead (up to 50 ppm). Arsenic may be present up to levels of 10 000 ppm. Other elements, such as aluminium, nickel, chromium, cadmium, bismuth, antimony, etc., may also be present depending on the contaminants present in the smelter feed. The weak acid will also be saturated with SO₂ (typically between 2000 ppm and 5000 ppm depending on the SO₂ content). This acid can be decomposed and the gases passed to the acid plant can be neutralised to produce gypsum for sale, or to be treated and disposed of, or used, e.g. if there is a leaching process nearby.

The sulphuric acid production process removes any residual dust and metals before the contact stage so that they are not transferred to the acid that is produced. The removal of dust and metals before the contact process (see Figure 2.3) means that these are not significant components in the gases emitted to air [234, UBA (D) 2007]. Acid mists can be emitted from the stack, and candle filters or wet scrubbers can be used where needed to eliminate these mists. It is reported that high fluoride levels in the gas reduce the mist elimination efficiency of candle filters [103, COM 1998] (see also the LVIC-AAF BREF [339, COM 2007]).

Any NO_x that is present in the gases treated in the sulphuric acid plant is absorbed in the acid that is produced. If the concentrations are high then a brown acid is produced and this may not be acceptable to potential customers. The problem is therefore one of potential sales. When sulphuric acid is brown due to organic compounds, hydrogen peroxide can be added to remove the colour.

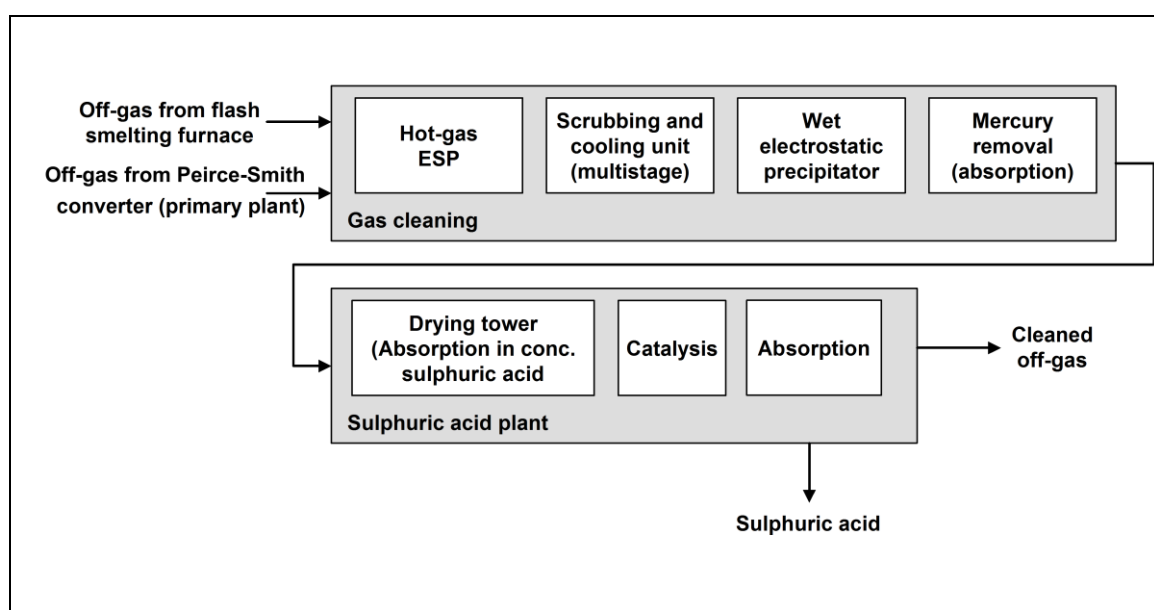

Figure 2.3: Typical gas-cleaning train for a sulphuric acid plant

The flue-gas from the flash furnace entering the acid plant of Głogów 2 in Poland contains a high level of NO_x (up to 1000 ppm) so, to maintain the required level of 5 ppm in the produced acid, there are two systems for decomposing the nitrogen oxides. One of them doses hydrazine to the drying and absorbing acid circuits, the other one decomposes nitrogen compounds from the mist eliminators condensate by diluting and blowing with SO₂-rich gas (Lurgi method) [238, ECI 2012]. A plant in the Netherlands uses SCR in the first pass to achieve the same quality of acid and the final emission of NO_x is quoted as 12 mg/Nm³ [240, Nyrstar Budel 2008].

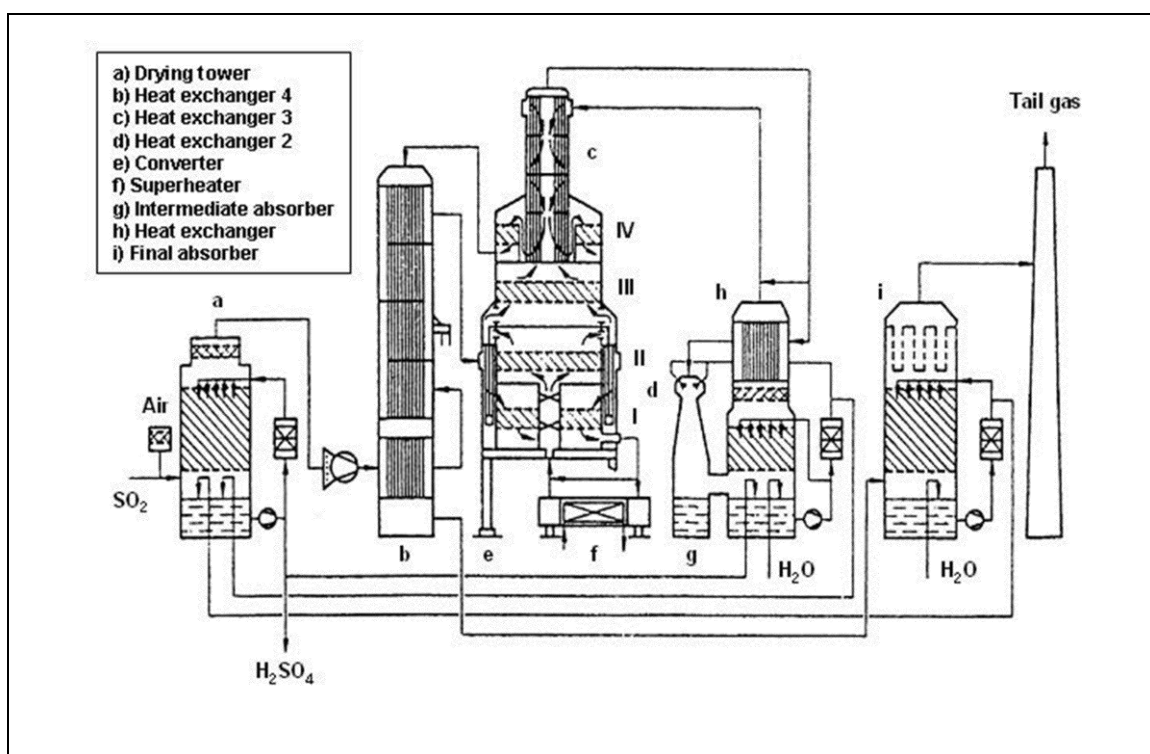

Figure 2.4: Typical double absorption sulphuric acid plant

Process control based on the measurement of SO_2 in the off-gas leads to a delayed reaction of the process. In the non-ferrous metals sector, the oxygen level can be used for process control, but makes the control of the sulphuric acid plant far more complex than for sulphur burning [234, UBA (D) 2007].

Sulphuric acid plants in this sector that have highly variable SO_2 inlet concentrations need to be operated at temperatures that are $20\text{ }^\circ\text{C}$ below the maximum catalyst temperatures, so that the catalyst is not deactivated. The effect is shown in Figure 2.5. Catalysts can also fail if the temperature is too low and, therefore, it is very important to keep the temperature level sufficiently high to prevent the catalysis from stopping quickly, which occurs at low SO_2 inputs. The temperature is about $10\text{--}30\text{ }^\circ\text{C}$ higher than in steady-state operation, causing a significant decrease in the conversion rate. The temperature operating window for a sulphuric acid plant in this sector, used as a sulphur recovery technique, is therefore more restricted than in a sulphur burning plant that is used as a H_2SO_4 production plant. For the same reasons, the SO_2 conversion yield is lower than the yield of a H_2SO_4 production plant.

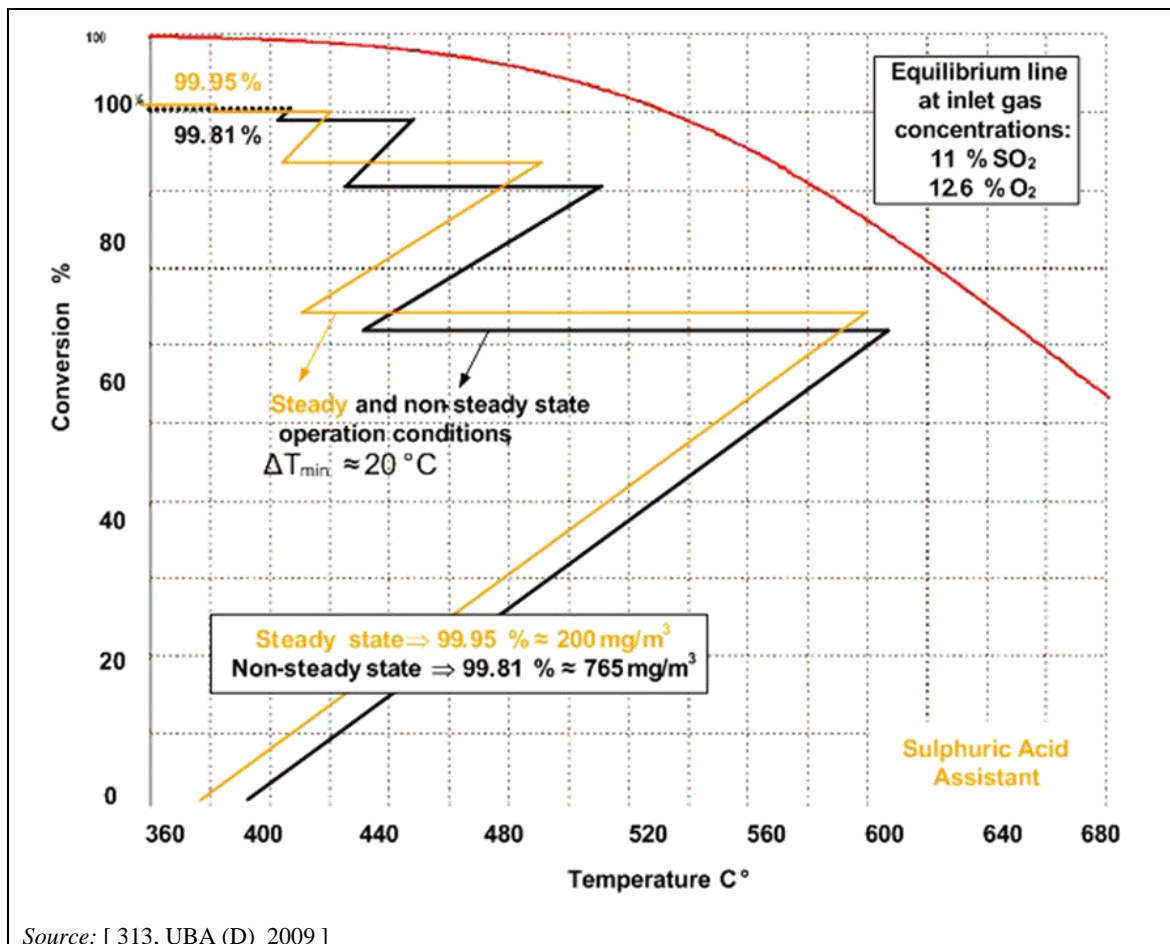

Figure 2.5: Comparison of the effect of steady- and non-steady-state SO₂ inlet concentrations on conversion efficiency

The emission of sulphur dioxide from sulphuric acid plants is proportional to the conversion rate, provided that the sulphur dioxide content of the feed gas is constant (respectively proportional to the sulphur dioxide content of the feed gas) [313, UBA (D) 2009]. Data are given in the LVIC-AAF BREF [339, COM 2007] for the conversion rate and outlet SO₂ concentrations for a number of inlet gas content. However, because of information missing from the LVIC-AAF BREF [339, COM 2007], the calculated number for other double contact/double absorption plants (680 mg/Nm³) does not take into account the reduction in gas volume that results from the absorption of SO₃ during the process. The correct equation for the calculation of the outlet concentration and the conversion rate is given in Figure 2.6, where η is the conversion rate and ρ is the density:

$$C_{\text{SO}_2, \text{out}} = \frac{(1 - \eta_{\text{SO}_2}) \times \rho_{\text{SO}_2} \times C_{\text{SO}_2, \text{inlet}} \times 10^6}{(1 - 1.5 \times C_{\text{SO}_2, \text{inlet}})}$$

Figure 2.6: Equation for the calculation of the outlet concentration and the conversion rate

The data for existing plants in the LVIC-AAF BREF [339, COM 2007] were calculated at 99.8 % conversion using an inlet SO₂ concentration of 11 %, and a waste gas concentration of 680 mg/Nm³ was predicted. The equivalent result when using the correct graph gives a predicted waste gas concentration of 770 mg/Nm³ using the same conversion rate and inlet gas concentration [313, UBA (D) 2009], [314, UBA (D) 2009]. As a consequence, the concentration given in Table 4.24 of the LVIC-AAF BREF for other double contact/double

absorption plants (680 mg/Nm^3) is now 770 mg/Nm^3 . The missing data have now been provided and the corrected graph is shown as Figure 2.7.

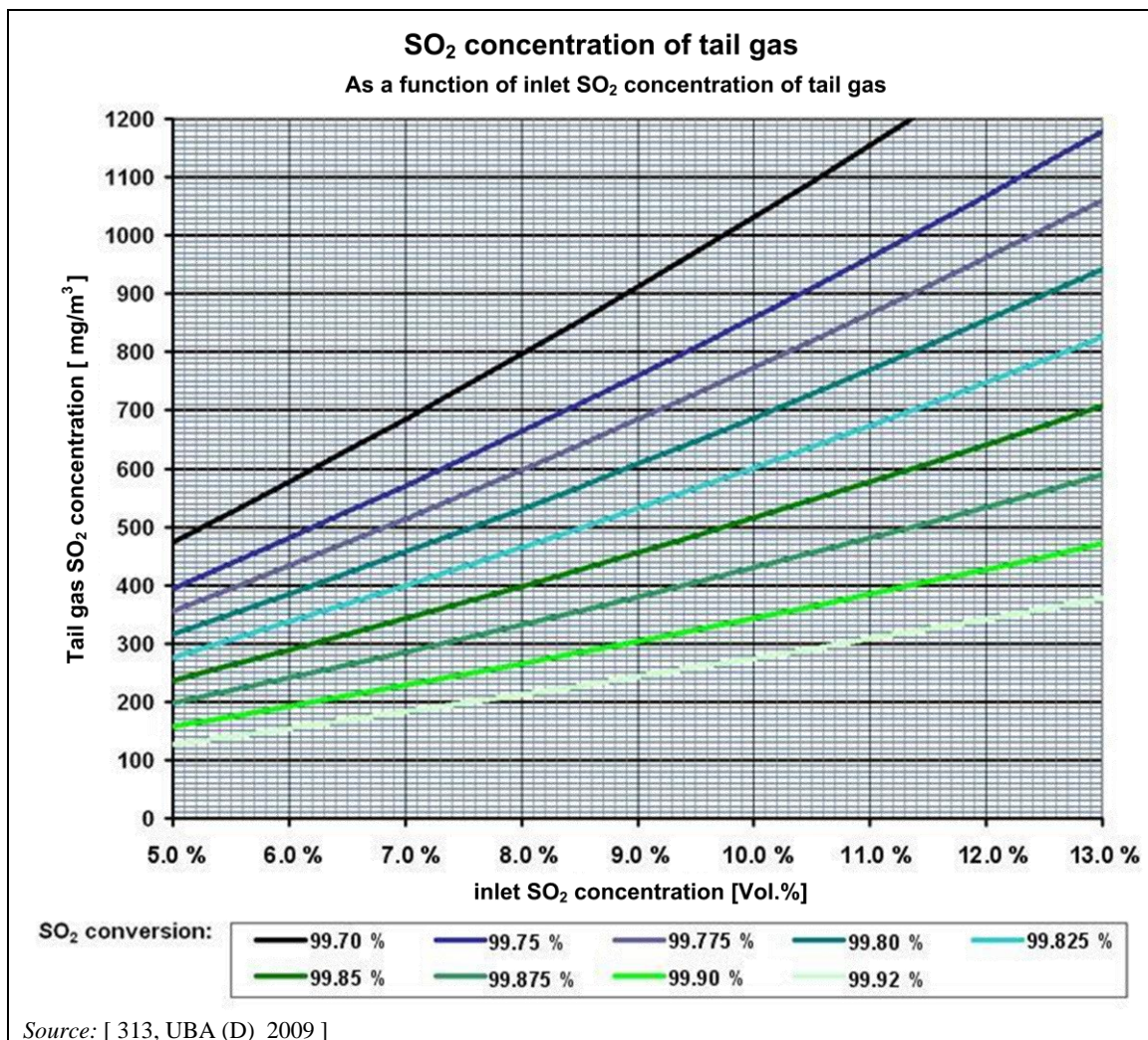

Figure 2.7: Conversion of SO₂ to sulphuric acid

2.7.2 Current emission and consumption levels

The performance of the EU-28 sulphuric acid plants associated with the production of non-ferrous metals is shown in Table 2.3, Table 2.4 and Table 2.5 [238, ECI 2012], [230, COM 2007], [229, Umicore etc. 2007], [233, COM 2008], [231, COM 2007]. Other relevant data are reported in the LVIC-AAF BREF [339, COM 2007].

Table 2.3: Double contact/double absorption sulphuric acid plants associated with non-ferrous metals production

Sulphuric acid plant data (with additional abatement measures where shown in Process type and plants operating normally)											
Company	SO ₂ source	Line	Capacity (t/d)	Process type	Number of beds	Cs-promoted catalyst	Inlet SO ₂ vol. (%)	Conversion rate (%)	SO ₂ year avg. (mg/m ³)	SO ₂ day avg. (mg/m ³)	SO ₂ max. 1/2 h avg. (mg/m ³)
Atlantic Copper, Huelva	Flash smelter and PS converter	1	2200	Double contact/ Double absorption	5	Partial fourth bed	5–11.5	99.7–99.83	500–700	400–800	Up to 1000
		2	600		4	Last bed	5.5–8.5	99.7	500–700	400–800	Up to 1200
		3	1300		5	None	5–10	99.7–99.8	500–800	Up to 900	Up to 1200
Aurubis AG, Pirdop	Flash smelter and PS converter	1	1862	Double contact/ Double absorption	4	Last bed	7.4–11.3	99.7–99.8	864	600–1000	Up to 1150
		2	1862		4	First and last bed	7.4–11.3	99.7–99.8			
KGHM Głogów 1	Hoboken converter	NR	700	Double contact/ Double absorption	4	None	4.5–8	99.8	NR	250–800	NR
KGHM Głogów 2	Flash furnace (for Cu), Kaldo furnace (for Ag)	NR	900	Double contact/ Double absorption	4	None	6–8	99.9	NR	140–800	NR
Boliden Harjavalta	Cu: flash smelter + PS converters, Ni: Flash smelter	1	2400	Double contact/ Double absorption	4	First bed	7–12	99.8–99.9	350	500	Up to 600
		2	1000		4	First bed	8–13	99.7–99.8	800	1000	Up to 1200
Aurubis AG, Hamburg	Flash smelter and PS converter	1	1300	Double contact/ Double absorption	4	First and last bed	5–12	99.7–99.8	500–800	270–1080	330–1980
		2	1300		4	First and last bed	5–12	99.7–99.8			
		3	1300		5	First bed	5–12	99.8			
Asturiana de zinc Xstrata zinc	Roaster	1	300	Double contact/ Double	4	None	7–8	99.5	1015	992–1365	NR
		2	450		4	None	7–8	99.5	1398	716–1320	NR

		3	850	absorption	4	None	7–8	99.7	1014	476–936	NR
		4	900		4	Last bed	7–8	99.7	715	441–894	NR
Xstrata Zink Nordenham	ZnS roaster	1	590	Double contact/ Double absorption	4	Partial first and third bed	5–8.5	99.5–99.7	NR	522	Up to 1300
Nyrstar Balen	Fluidised bed roaster (zinc conc.)	F5	850	Double contact/ Double absorption	4	Last bed + top layer third bed	8–9.5	99.5–99.6	800–1200	NR	Up to 1500
Nyrstar Auby	Fluidised bed roaster (zinc conc.)	1	570	Double contact/ Double absorption	4	NR	8–8.5	99.5–99.7	900–1200	NR	NR
Kemira Kokkola	Boliden Kokkola roaster,	1	1000	Double contact/ Double absorption	4	None	6–9	99.6–99.8	600–1000	NR	Up to 400
Boliden Odda	Zn-Smelter	1	370	Double contact/ Double absorption	4	Partial first and third bed	7–8	99.2	900–1500	NR	NR
				Wet scrubber with seawater	NR	NR	NR	NR	NR	NR	50–300 Based on two spot samples per year
BBH Stolberg	QSL-Pb smelter	NR	360	Double contact/ Double absorption	4	Top layer first bed + complete fourth bed	5–12	99.6–99.7	1000	NR	490
Weser-Metall, Nordenham	Ausmelt Pb smelter	1	300	Double contact/ double absorption	5	First bed partial fourth	2–8	99.4–99.7	600–1100	200–800	Up to 1300
NB: NR = Not reported. Source: [238, ECI 2012], [230, COM 2007], [229, IZA plant data 2008], [233, COM 2008] [231, COM 2007], [378, Industrial NGOs 2012]											

Table 2.4: Upgraded sulphuric acid plants with lower SO₂ inlet concentration variations associated with non-ferrous metals production

Sulphuric acid plant data (plants operating normally)										
Company	SO ₂ source	Capacity (t/d)	Process type	Number of beds	Cs-promoted catalyst	Inlet SO ₂ vol. (%)	Conversion rate (%)	SO ₂ year avg. (mg/m ³)	SO ₂ day avg. (mg/m ³)	SO ₂ max 1/2 h avg. (mg/m ³)
Boliden Rönnskär	Roaster, smelter, flash smelter, PS converter	2000	Double contact/ Double absorption	5	Last bed	7–10.5	99.97	100–160	NR	NR
Boliden Rönnskär	Roaster, smelter, flash smelter, PS converter	NR	Cold seawater plant	NA	NA	7–10.5	NR	120–220	NR	NR
Umicore Hoboken	ISASMELT	360	Double contact/ Double absorption	4	Last bed	Min. < 1 Max. 7–10	> 99.7	80	55–246	Up to 300
KCM Plovdiv	Zn roaster	440	Double contact/ Double absorption	4	Last bed	6–7.5	99.8–99.85	140–280	NR	Up to 360
Nyrstar Budel	Fluidised bed roaster (zinc conc.)	1000	Double contact/ Double absorption	5	Yes	5–7.2 (low variation inlet conc.)	Up to 99.97	50–80	NR	39–193

NB: NA = Not applicable; NR = Not reported.

Source: [378, Industrial NGOs 2012], [238, ECI 2012], [230, COM 2007], [229, IZA plant data 2008], [233, COM 2008], [231, COM 2007], [378, Industrial NGOs 2012]

Table 2.5: Single contact sulphuric acid plants associated with non-ferrous metals production

Sulphuric acid plant data (with additional abatement measures and plants operating normally)											
Company	SO ₂ source	Line	Capacity (t/d)	Process type	Number of beds	Cs-promoted catalyst	Inlet SO ₂ vol. (%)	Conversion rate (%)	SO ₂ year avg. (mg/m ³)	SO ₂ day avg. (mg/m ³)	SO ₂ max. 1/2 h avg. (mg/m ³)
KGHM Legnica	Shaft furnace, Hoboken converter	1	210	Single contact/ Single absorption and Solinox plant	4	None	5–12	96–98	NR	200–600	NR
		2	210		4	None	5–12	96–98	NR	200–600	NR
Nyrstar Balen	Fluidised bed roaster (zinc conc.)	F4	320	Single absorption with ZnO scrubber	4	Last bed	4.5–7	98.8–99.1	NR	600–900	Up to 1700
Sadaci	Molybdenite roaster	1	115	WSA condenser	3	First two beds	1–3.5	99	NR	320–450	100–700

NB: NR = Not reported.

Source: [238, ECI 2012], [230, COM 2007], [229, IZA plant data 2008], [233, COM 2008], [231, COM 2007], [378, Industrial NGOs 2012].

2.8 Water and waste water management

This section gives an overview of the generation of liquid effluents in a common process. The ways to reduce the volume of waste water and the practice of recycling water are discussed to give an understanding of some of the concepts that may be transferred between the metal groups [27, M. Barry et al. 1993]. The effluent treatment in a waste water treatment plant is described in Section 2.12.6

2.8.1 Main sources of liquid effluent

The production of non-ferrous metals by pyrometallurgical and hydrometallurgical methods is associated with the generation of different liquid effluents. The main sources of the most important effluent streams can be classified as shown in Figure 2.8.

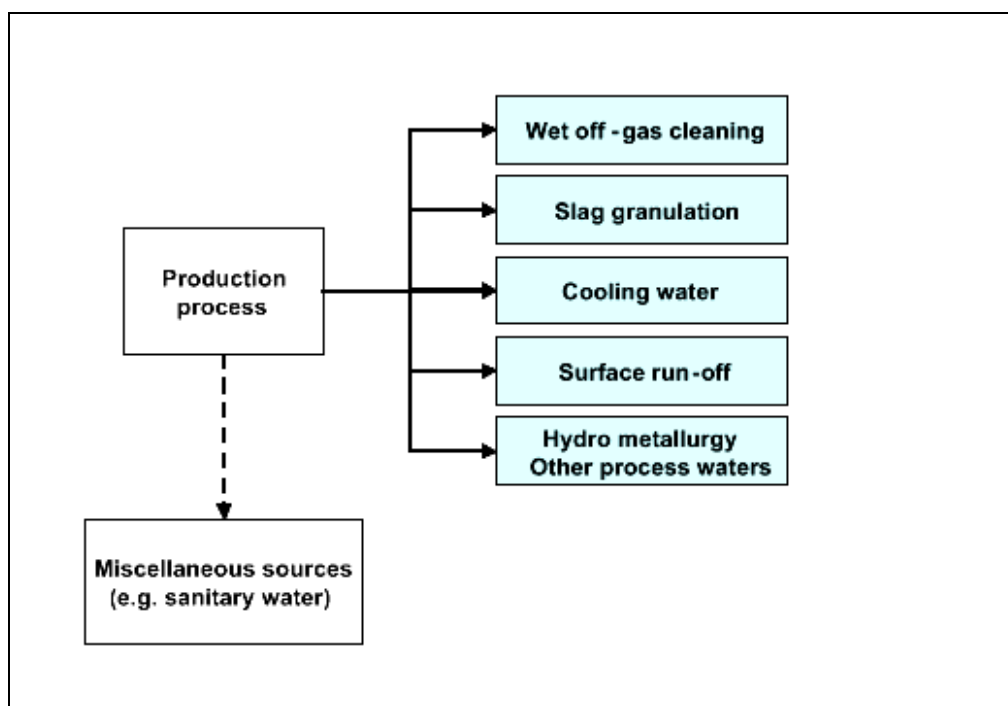

Figure 2.8: Effluent classification

The above waste water streams can be contaminated by metal compounds from the production processes and may have a high environmental impact. Even at low concentrations, some metals like mercury and cadmium are very toxic. This can be illustrated by the fact that mercury and cadmium head the list of priority hazardous substances drawn up at the North Sea Conference of 1984, which called for a 50 % reduction of emissions into the North Sea. The toxic effect of some metal compounds is also due to the fact that, under the correct chemical conditions, metals can easily enter natural watercourses as soluble species and be quickly and irreversibly assimilated into the food chain [166, Clark, J.H. 1995] (see also Annex 13.2.2 for the MERAG methodology [301, MERAG 2007]).

2.8.1.1 Effluents from off-gas cleaning

Wet air pollution control equipment is gradually being replaced by dry control techniques. Dry abatement techniques like fabric filters have the advantage that no sludge or waste water are treated and the collected dust can often be recycled directly back into the main process, and so the cross-media issues are therefore reduced in comparison to wet systems.

There are certain cases when wet air cleaning techniques, e.g. wet scrubbers or wet electrostatic precipitators, need to be applied. These are used especially when other abatement systems are not suitable, where there is a risk of explosion or combustion from flammable particles, and if gaseous substances (for example, sulphur dioxide or trioxide) as well as particles have to be removed from the off-gas stream. Wet electrostatic precipitators are necessary when humid, saturated gases with a high dust content have to be cleaned. For example, during the production of primary zinc and copper, the off-gas from the process, which contains dust and sulphur dioxide, is cleaned using a scrubber and a wet electrostatic precipitator. Wet electrostatic precipitators are also used to collect the tar mist in the off-gases from an electrode-baking furnace. In wet scrubbers, acceleration and deceleration of the gas stream and the atomised scrubbing liquid produces high turbulence between the gases, the dust and the droplets of liquid. The dust particles are very quickly wetted and chemical reactions are speeded up. A subsequent collector extracts the droplets of liquid and the wetted dust from the gas steam. The contaminated effluent can then be removed for further treatment. If there is no enrichment of soluble components in the scrubbing liquid, removal of the suspended solids by a thickener makes it possible to reuse the scrubbing liquid. However, in some cases, precipitation of soluble components should be carried out in order to reuse the spent scrubbing liquid.

The liquid effluent generally requires further treatment, for instance by neutralisation and/or sedimentation for solid-liquid separation. Sometimes specific treatment measures like ion exchange are used to remove very harmful or valuable metal compounds. For example, ion exchange is used to recover rhenium from the scrubber effluent that is generated by cleaning the off-gas from a molybdenite roaster. This process is used for both removing a metal compound from the waste water and serves as the most important source for the production of rhenium metal.

Weak acid produced in wet electrostatic precipitators can be treated in a number of ways:

- by concentration and then decomposition in the smelting furnace, when SO_2 can be recovered in the acid plant;
- the treated liquid can normally be sent back to the wet cleaning system, but a bleed is required to control the composition of the scrubbing liquid;
- weak acid from these processes can also be reused in other processes if they are available.

It has been reported that in several cases the process water from the wet scrubbing system of a smelting furnace contains cyanides formed by the reaction of carbon with atmospheric nitrogen. The cyanide level can be reduced by using the scrubbing water for slag granulation, which leads to evaporation and oxidation of most of the cyanides.

Another main effluent stream arises from the removal of mercury from some roaster off-gases. The mercury removal step involves a gas-liquid contact tank with a solution of mercury chloride (HgCl_2). This mercury chloride reacts with metallic mercury from the gas to form a solid Hg_2Cl_2 precipitate (calomel). The precipitated slurry is removed and oxidised with Cl_2 to form the HgCl_2 washing solution. Some of the slurry is dewatered by a filter press and sold as Hg_2Cl_2 for mercury recovery or disposed of as a special waste.

Effluents from the process are pretreated locally for mercury removal by reaction with zinc dust or by precipitation as HgS , before processing in a final effluent treatment plant.

2.8.1.2 Effluent from matte or slag granulation and the production of metal shot and density separation

During the production of non-ferrous metals, the matte, slag and produced metal will be tapped off from the furnaces. The materials can be granulated separately by pouring them into water, using a high-pressure water jet or other quench systems to form evenly sized particles. The granulated metal can then be sold as metal shot. The granulated slag may be used for other purposes and granulated matte can be used in a converter stage. A typical granulation stage is shown in Figure 2.9.

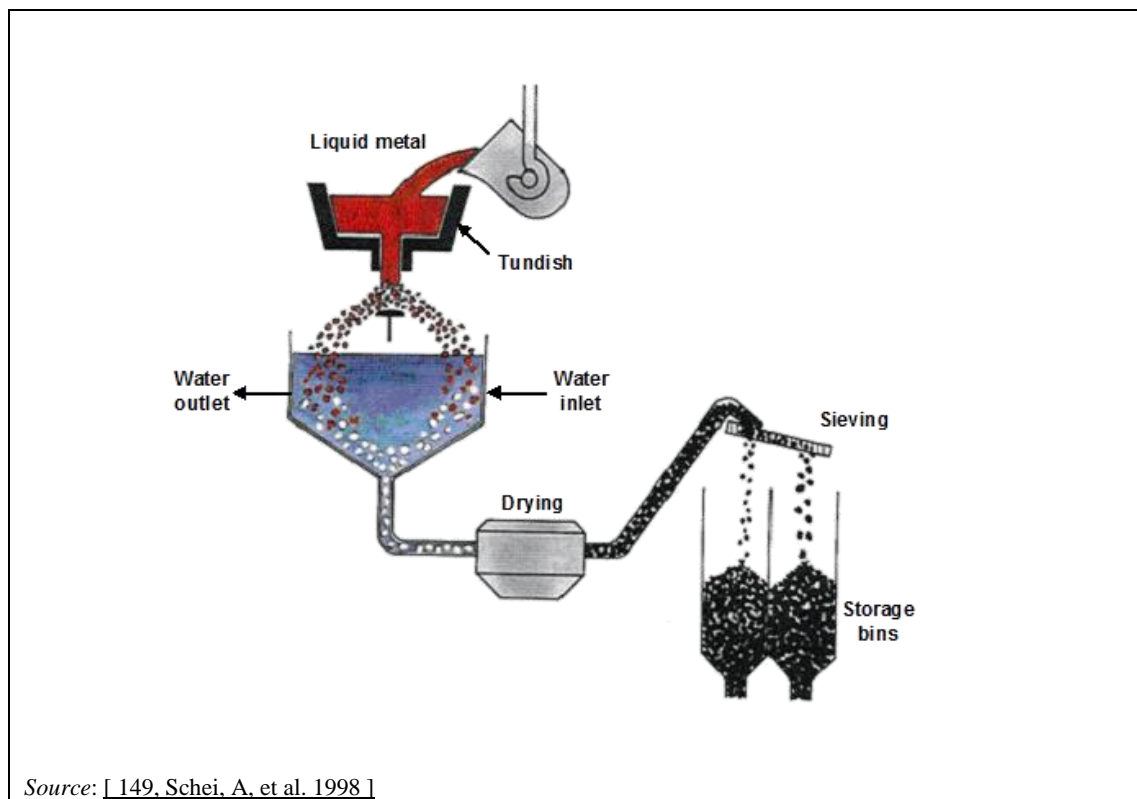

Figure 2.9: Granulation of molten metal

The liquid effluent that arises from the granulation step is usually recycled in a closed circuit (see Figure 2.10). To prevent the build-up of suspended solids and metal compounds, the blowdown should be removed from the water circulation system continuously.

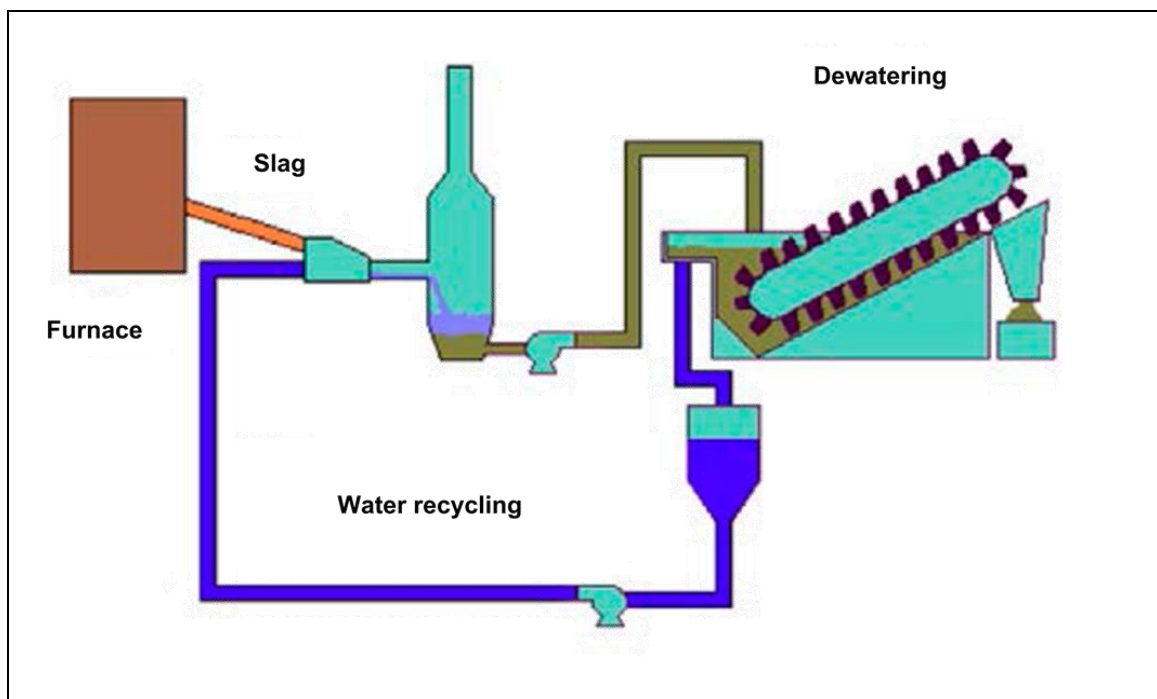

Figure 2.10: Closed water loop in granulation systems

Relative density separation (sink or swim) is also used to separate metals and compounds from light contaminants, for example the removal of plastic components after shredding. The liquid effluent that arises is usually recycled and floating material is removed. To prevent a build-up of suspended solids and metals, the blowdown should be removed from the water circulation system continuously.

The blowdown or effluent is usually sent to a central waste water treatment plant.

2.8.1.3 Cooling water

Cooling water is used on a large scale for the different cooling requirements in metal-producing industries. It can be divided into non-contact cooling water and direct-contact cooling water as detailed below.

- Non-contact cooling water is used for cooling furnaces, furnace hoods, casting machines, etc. Depending on the location of the plant, cooling can be achieved by a once-through system or a recirculation system with evaporative cooling towers. Water from a once-through cooling system is normally discharged back to the natural source, for instance a river or a cooling pond. In this case, the potential increase in temperature should be considered before the water is discharged to the natural water body. Non-contact cooling water may also be recycled via cooling towers.
- Direct-contact cooling is used during some casting operations. This cooling water is normally contaminated with metals and suspended solids and often arises in large quantities. Due to the specific matrix and in order to avoid dilution effects, direct-contact cooling water should principally be treated separately from other waste water.

The amount of heat emissions and maximum discharge temperatures depend on local conditions. Specifically, the impact on the aquatic environment has to be considered on a case-by-case basis. If needed, cooling of the processes has to be expressly designed. If process cooling is required, it can be applied by:

- heat exchange with water (surface water or similar);
- heat exchange with air;
- evaporation cooling towers.

In order to minimise the impact of cooling on the environment as a whole, the BREF on Industrial Cooling Systems should be used.

2.8.1.4 Surface run-off water

Surface run-off water arises from the contamination of rainwater that is collected from building roofs and paved areas at the production facility. Contamination of rainwater occurs when materials such as dust that contain metals from storage, surface deposition, etc. or oils are washed into the drainage system. Contamination of surface water can be prevented or minimised by using good practice for the storage of raw materials, as well as by good maintenance and cleaning of the whole production plant.

Surface run-off water may be collected separately. After a sedimentation step or chemical treatment, it can be reused for other purposes in the production process, for instance as cooling water or for water sprays to prevent dust formation.

2.8.1.5 Effluents from the hydrometallurgical process

The main liquid effluents arising from the hydrometallurgical production of non-ferrous metals are listed in Table 2.6 below.

Table 2.6: Potential sources of liquid effluents from the hydrometallurgical production of non-ferrous metals

Process unit	Operation/source	Use options
Roaster gas cleaning	Wet cleaning of roaster gases	Waste water treatment plant consisting of precipitation steps, sometimes with removal of metals using ion exchangers
Leaching	General operations including wet gas cleaning	Return to leaching
Purification	General operations	Return to leaching or next process step
Electrolysis	Cleaning of cells, anodes and cathodes. Spent electrolyte. Electrolyte bleed	Return to leaching. Return to electrolysis after treatment

The hydrometallurgical production process usually starts with a leaching operation. During leaching, the desired metal and other elements will be liberated from the mineral and dissolve into the liquid phase.

Typical leaching reagents and reactions are shown below [104, Ullmann's Encyclopedia 1996]:

- water for water-soluble compounds (copper sulphate);
- sulphuric, hydrochloric and nitric acids or sodium hydroxide for metal oxides;
- complexing agents, e.g. cyanide (gold, silver) or ammonia (copper and nickel minerals);
- reduction of a mineral by a suitable gas or oxidation, for example, manganese dioxide by sulphur dioxide, and nickel matte by chlorine;
- acid-base reactions, e.g. recovery of a tungsten complex from tungsten at a high pH.

To increase the amount of the desired metal in the leach liquor, a number of hydrometallurgical purification and enrichment techniques may be used. The target metal may be recovered from the purified solution using different techniques such as cementation, gaseous reactions, selective precipitation, ion exchange, solvent extraction, crystallisation, evaporative concentration or electrolysis. To ensure a correct balance in some of these processes, it is normally necessary to constantly remove part of the liquor.

During the production of zinc for instance, the electrolyte may be bled to control the build-up of magnesium, which otherwise may have a detrimental impact on the operation of the electrolytic cells. The flows in the electrolytic cells belong to the same (closed) water circuit as the leaching and purification stages: the sulphuric acid formed during electrolysis is fed to the leaching process and the remaining liquid is purified and fed to the electrolytic process.

The effluent bleed of the electrolysis-leaching-purification circuit is strongly acidic and contains high concentrations of zinc and suspended solids. The volume of the bleed depends strongly on the composition of the zinc concentrates that are used in the roasting. Components that tend to build up (i.e. are not sufficiently removed from the solution) in the circuit, especially magnesium, will determine the bleed flow.

Many facilities have already demonstrated that effluents generated as electrolyte bleed may be recycled to the leaching operation depending on the contaminants that are present. Electrolyte bleed may also be recycled to electrolysis after the removal of contaminants or low-value elements.

2.8.1.6 Other process waters

There are other sources of effluent in this sector. The most important are:

- the liquors produced during the Bayer process to produce alumina;
- acidic waste waters produced during lead-acid battery processing or the processing of precious metals;
- weak sulphuric acid from sulphuric acid plants;
- waste waters from the refining of germanium, gallium, etc.

These waste waters are covered in more detail in the metal-specific chapters but the processes used are sometimes capable of recycling the liquors back into the process or using the acid value in other processes.

Pickling operations are also sources of process waters and the following two examples show how non-acid pickling can be used and how the impact of acid pickling can be minimised.

Non-acid pickling

This process operates in a sealed circuit. Rods can be pickled in an in-line system that consists of a compartmentalised horizontal steel pipe. A 2.5–5 % solution of isopropanol (IPA) in water is used. In copper, the process of converting the cuprous oxide scale in the vapour phase to form copper (left on the rod) is known as the Burns process [90, Traulsen, H. 1998]. The spent pickling solution could be processed for IPA recovery or vacuum distilled. The sludges/solids separated from pickling solutions are used for metal recovery. Water from the IPA recovery and spent pickling solution distillation could be recycled for emulsion preparation or sent for waste water treatment.

Acid pickling

Acid pickling uses a compartmentalised horizontal system [90, Traulsen, H. 1998]. In the first stage, the material is pickled with diluted sulphuric acid; then the residual acid is washed in several stages from the metal surface by water sprays, followed by drying using compressed air. Surface pickling is usually performed with sulphuric acid, but for some alloys and for metals

such as titanium, nitric acid, sometimes as a mixture with sulphuric acid, is used in continuous lines or automatic systems. Gas cleaning is used to recover or remove nitric acid fumes; the acid is changed from time to time. Spent acid is sent for treatment and the recovery of metal. The pickling systems are vented for worker protection.

The products are rinsed, the rinse water is sent for treatment, and the sludges are recycled if possible. For surface degreasing of rolled products, detergents are used. The spent water is cleaned by ultrafiltration. If organic solvents are used for surface degreasing, a vapour degreasing system is used. In this case, chlorinated hydrocarbons may be present in any waste water treatment sludge that is produced.

An alternative process is used for some copper rod production. After partial cooling in a long water-filled tube, the rod is formed into spirals corresponding to the diameter of the coil. These spirals are spread onto a roller table where the temperature is reduced to 20 °C by water sprinklers. An acid-resistant alloy conveyor carries these spirals into the pickling tanks where the rod is pickled with a 20 % sulphuric acid solution. The acid pickling system ensures a perfect removal of all oxides from the rod surface. The loops are then washed with rinsing water and finally protected by a wax solution.

Electrowinning can be used to recover the metal dissolved by the pickling acid. The wash solution may also be treated by ion exchange.

2.8.1.7 Miscellaneous sources

In an industrial plant for producing non-ferrous metals, a great number of other sources are involved. Examples are liquid effluents from cleaning stations for trucks delivering raw material; sealing water from pumps; and general operations, including the cleaning of equipment, floors, etc. These liquid effluents are normally collected and treated. Water from the sanitary system is normally discharged to the public sewerage system.

2.8.2 Applied processes and techniques

Process-integrated measures and waste water treatment techniques are described

2.9 Residue management

The production of non-ferrous metals from primary and secondary raw material is related to the potential generation of a wide variety of by-products, intermediate products and wastes. The focus should always be on the minimisation of waste by optimising the process and by utilising residues and wastes as far as possible, provided there are no negative cross-media effects. These residues arise from different stages of the production process such as from the metallurgical operations and the smelting process as well as from the off-gas and waste water treatment [83, NRW (D) 1997]. The content and value of the elements contained in the residue influence its potential for reuse, e.g. anode slime is a viable raw material for the recovery of precious metals. Any designation of a residue as waste for disposal should take this into account. Also, some filter dust such as silica fumes that arise from the smelting process of ferro-silicon and silicon metal can be used as a by-product [226, Nordic Report 2008].

According to current EU legislation (Directive 2008/98/EC on waste (Waste Framework Directive)), many of these residues are regarded as wastes. However, the non-ferrous metals industry has for many decades used numerous residues as raw materials for other processes and an extensive network of metallurgical operators has long been established to increase the recovery of metals and reduce the quantities of waste for disposal. It has been reported that some legislative measures to control waste movements are inhibiting the recycling of residues from metallurgical operations [96, Bontoux, L. et al. 1997]. It is also well known that the metal-producing industries obtain one of the highest recycling rates in all industrial sectors: most of the materials listed above are recycled or reused within the non-ferrous metals industries themselves as well as in other industries, for example in the cement, abrasives manufacturing and construction industries (see Figure 2.11). It is not the intention to discard or dispose of them. They are the result of the metal separation that is necessary for their recovery and the production of pure metals from complex sources. This helps to reduce cross-media issues to a minimum. Nevertheless, the problem of residues from production facilities and the designation of some of these materials will also play an important role in future permits and the techniques tend to concentrate on this aspect. A substance may however be described as a waste, or as a secondary raw material, depending on the context of its production, transport, and use or recovery.

According to a research project on the avoidance and recycling of waste from a large number of non-ferrous metals smelting plants in North Rhine-Westphalia, the following breakdown in Figure 2.11 demonstrates the importance of the different recycling routes.

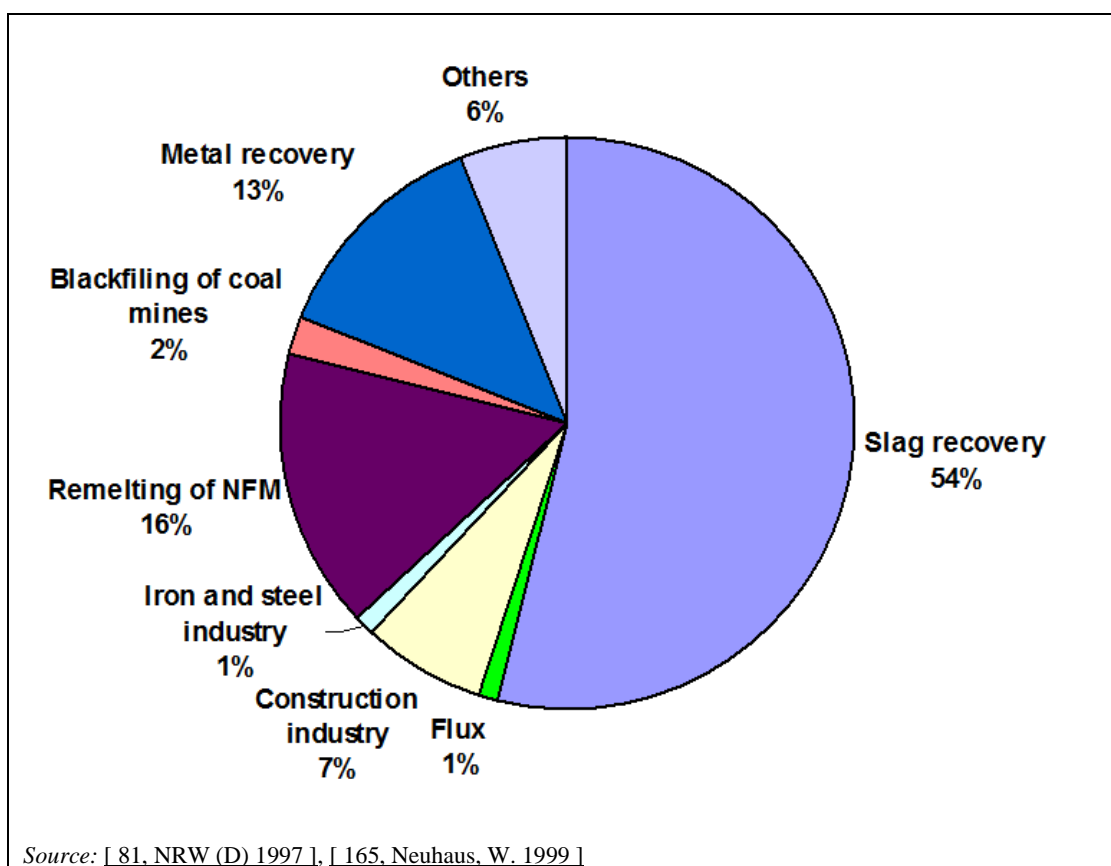

Figure 2.11: Different recycling routes according to the amount of residues generated by some non-ferrous metals plants in North Rhine-Westphalia

An indication of the most commonly applied processes and techniques is given in the following sections. Detailed information can be found in the metal-specific chapters.

2.9.1 Applied processes and techniques for residues from the smelting process

The main residues arising from the smelting of non-ferrous metals are slag, dross and skimmings removed during the pyrometallurgical processes. Slag is generated by the reaction of slag-forming accompanying elements (e.g. Fe) with added fluxes. In the smelting process, the slag is liquid and has a different density to the melted metal and can therefore be tapped off separately.

Most of the slag generated by downstream or refining operations in non-ferrous metals production processes can usually be recycled or used for further metal recovery. Figure 2.12 shows the electric furnace cleaning of copper slags to achieve the internal recycling of the slag. In this example, molten slag obtained from the converter, which has a high copper content, is returned to the smelter. The slag leaving the smelter is decopperised in an electric slag cleaning furnace. This furnace is operated continuously with an almost continuous flow of slag. Depending on local facilities, the resulting clean slag is either granulated to produce abrasives or cooled slowly and broken into lumps for filling or construction material.

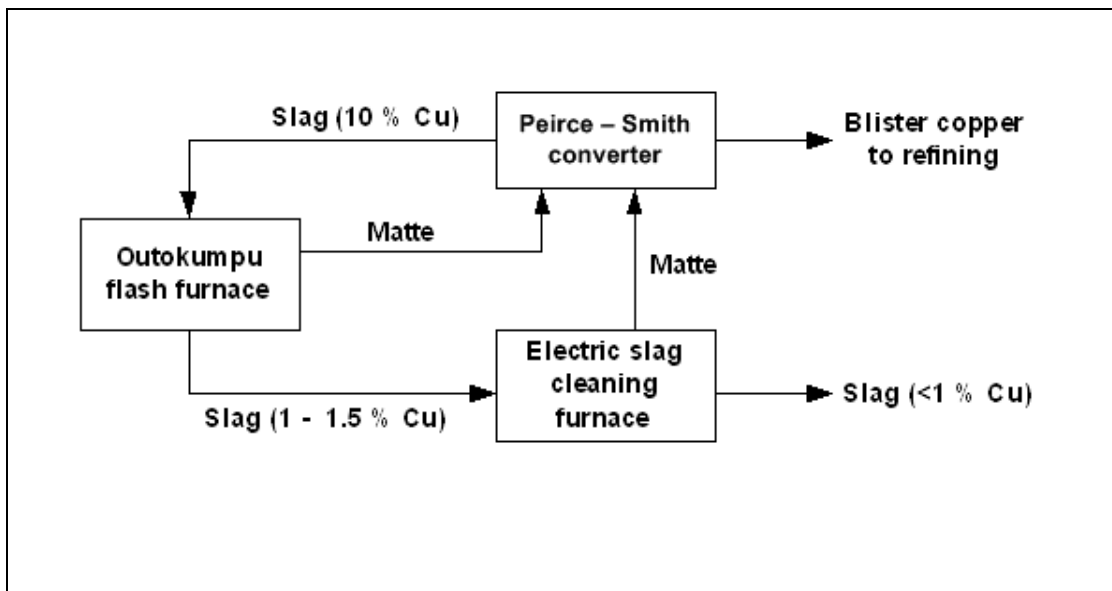

Figure 2.12: Electric furnace cleaning of copper slags

There is a distinction between slag with a high metal content, which is recycled within the process or transferred to another process or site for recovery, and final slag with a low metal content.

Several facilities in the non-ferrous metals industries have demonstrated that there is a market in which they are able to sell slag for further beneficial use. The use of slag as a construction material to replace aggregates is only possible if the amount of leachable metal compounds is low. There are various tests to demonstrate this, such as [268, Belgium 2008], [289, USEPA 2008]. Slag that cannot be used as an abrasive or in civil engineering and construction is used for recycling, or used as construction material in special cases (e.g. construction of disposal areas), or sent for disposal.

Salt slag is generated by melting light metals (aluminium, magnesium). The use of a salt flux prevents the melted metal from oxidising and binds the impurities from the process. There are different ways to minimise the amount of salt flux used, as well as different treatment techniques for salt and metal recovery and they are discussed in more detail in Chapter 4.

Dross and skimmings are generated by the oxidation of metals at the bath surface or by reactions with fireproof material used as furnace linings. The metal content of skimmings/dross is relatively high (between 20 % and 80 %), therefore they can normally be recycled to the main process or supplied to other non-ferrous metal plants for recovery of metals.

Another source of residues is spent linings and refractories. These arise when refractory material falls out of the furnace linings or during the complete renewal of the furnace lining. The durability of a furnace lining is between a few weeks and several years depending on the process and metal (e.g. for the Outotec flash furnace in primary copper production, 6 to 10 years is possible). The amount of spent furnace lining material arising could be up to 5 kg per tonne of metal produced depending on the melted metal [83, NRW (D) 1997]. The following practices are used for furnace linings: treatment in a smelter to form an inert slag, e.g. linings from a brass melting process are sent directly to a local secondary copper smelter; use as a component in the taphole mass; disposal of inert linings. Table 2.7 gives an overview of the amount of recycled, reused and discharged residues from some non-ferrous metal smelting furnaces in Germany. In this sense, recycling means that the residue is returned to the process in which it was produced. Reuse means that the residue is used for another purpose, e.g. slag may be reused as a construction material

Table 2.7: Amount of recycled, reused and discharged residues reported in 1996 for some non-ferrous metals plants in North Rhine-Westphalia

Residue	Amount of residue reported in tonnes in 1996		
	Recycled or reused	Disposed of	Total amount
Refractory waste (silicon dioxide)	21	188	209
Refractory waste	1655	1145	2800
Refractory waste with harmful components	637	728	1365
Slag	16 869	3	16 872
Dross from lead smelting	1903	0	1903
Aluminium-containing skimmings/dross	45 904	927	46 831
Magnesium-containing dross	615	81	696
Salt slag from aluminium smelting	112 438	0	112 438
Other residues	348	0	348

Source: [81, NRW (D) 1997]

2.9.2 Applied processes and techniques for residues from abatement systems

Abatement systems are another major source of solid materials. These are flue-gas dust and sludge recovered from the air pollution control equipment, as well as other solid waste like spent filter material such as filter bags.

Dust from the storage and handling of raw material or from preprocessing unit operations is collected by the dedusting system (usually a fabric filter) and sent back to the main process or another smelter. In some cases, the dust should be agglomerated before it can be recycled to the raw material storage and handling station.

Dust-laden off-gas from the smelting and refining facilities can be cleaned (as described in Section 2.12.5) using different abatement techniques. The material collected as dust by the off-gas cleaning can be agglomerated and sent back to the smelter or supplied as a raw material for further metal recovery in other facilities. An example is the zinc-rich dust from a converter or an electric slag cleaning furnace in the primary copper smelting process, which can be treated as a by-product and reused as a raw material in a zinc recovery plant [90, Traulsen, H. 1998]. Another example is the use of silica fumes (micro-silica), which are collected in the fabric filter by smelting silicon metal or ferro-silicon and sold as a valuable by-product to the construction industry.

The sludge from a scrubber that contains metal is normally drained, for instance in a chamber filter press, and sent back to the smelter.

When off-gas cleaning takes place in a dry dedusting system, the filter material should occasionally be replaced. The filters contain metal compounds and particles from the process. There are a number of examples where filter material is used in the pyrometallurgical process. If this is not possible, it is sent for final disposal to an incinerator or another disposal site. Table 2.8 gives some information about the amount of recycled, reused and discharged residues from abatement systems in some non-ferrous metals plants in Germany.

Table 2.8: Amount of recycled, reused and discharged residues reported in 1996 for some non-ferrous metals plants in North Rhine-Westphalia

Residue	Amount of residue reported in tonnes in 1996		
	Recycled or reused	Disposed of	Total amount
Dust that contains metals	6550	1886	8436
Dust	201	13	214
Mineral residues from the abatement system	2638	1752	4390
Sludge	508	4	512
Dust that contains aluminium	1477	66	1543
<i>Source: [82, NRW (D) 1997]</i>			

The quantity of spent filter bags may be decreased by using modern filter materials that are more robust. Fabric filters are characterised as an abatement technique that does not need very much maintenance. In the case of bag damage, the appropriate filter compartment can be isolated with cover plates until repairs can be carried out safely. A filter change is normally only necessary if 10–20 % of the filter compartments have been taken out of service.

The replacement of filter bags with modern, reliable fabrics is often easy but the technical requirements and the related investment costs of individual cases should be considered. In the case of a conversion or renewal of the filter system, the service life and the filter susceptibility can mean fewer bags are necessary. If this results in additional installation costs, they can usually be compensated for by the decrease in the number of bag failures.

2.9.3 Applied processes and techniques for residues from liquid effluent treatment

Pyrometallurgical processes for the production of non-ferrous metals do not normally produce harmful waste water. The water is used for the direct or indirect cooling of furnaces, blowing lances and casting machines, e.g. for copper anode or continuous casting. This water is warmed up by cooling the equipment but is normally not polluted with chemical impurities or metal particles. Therefore cooling water is usually discharged directly back into the receiving source after settlement or another treatment step. Solid material that is removed is returned to the smelter.

If a wet scrubber is used for cleaning the process off-gas, waste water is generated. This stream of waste water should be treated to reduce the amount of metal compounds. This treatment produces sludge that may be rich in metal and can sometimes be recycled to the process if the metal content is high enough.

Process water arises from hydrometallurgical operations and presents a high risk of water pollution. It should therefore be cleaned in a waste water treatment plant. The cleaning takes place by the neutralisation or precipitation of specific ions. The main residues from these effluent treatment systems are gypsum (CaSO_4), metal hydroxides and sulphides. The sludge is sometimes recycled back to the main production process.

2.9.4 Applied processes and techniques for residues from the non-ferrous metals hydrometallurgical processes

The production of non-ferrous metals by hydrometallurgical processes is another significant source of solid residues. The leaching process can generate relatively large quantities of sludge (e.g. approximately 0.3–0.5 tonnes of iron-based solids per tonne of zinc depending on the quality of the concentrate). These residues are normally disposed of in specially sealed lagoons or underground deposits, e.g. blasted mountain caverns. Some residues are also compacted or treated in the Jarofix process before disposal.

The leaching and purification process and electrolytic process also generate other metal-rich solids. They are usually rich in a specific metal and can sometimes be recycled to the production process or sent for metal recovery to other non-ferrous metals facilities (e.g. for the production of precious metals, lead, copper and cadmium). The anode slime from the copper tank house for instance is one of the most important raw materials for the recovery of precious metals and is therefore considered a valuable by-product of copper production. These issues are discussed in the chapters dealing with the individual metal groups.

2.9.5 Applied processes and techniques for other residues from the production of non-ferrous metals

Wherever practicable, waste streams incidental to the main processes should be segregated for recovery or appropriate safe disposal.

All machinery that is operated in an industrial installation uses oil as a lubricant. This should be changed, due to metal pick-up and chemical reactions in the oil. Regular maintenance, repairs and preventive maintenance can minimise oil loss by leakage and increases the intervals between the oil changes. A reduction in the quantity of oil used is also achieved using filtration, which gives an extension of the service life. For example, bypass filters may be installed to continuously clean a small part of the oil. These measures cause result in an extension of the service life by up to a factor of 10 depending on the specific filter system. If used oil filters are collected separately, they can be crushed in a shredder. The metal can be reused in a smelter as secondary raw material, and the oil can be centrifuged and then sent to a used oil refinery (or in some countries, e.g. Italy, it is compulsory to send it to a consortium or agency).

In some circumstances, these oil residues can be used as a source of energy on site, but since this technique involves the (co)incineration of waste, the installation should comply with Chapter IV of the IED.

2.9.6 Examples of recycling and reuse

As already shown in this section, residues from the production of non-ferrous metals can be recycled and reused to a large extent. Table 2.9 summarises the different possibilities for recycling and reusing these residues. More information can be found in the metal-specific chapters.

Table 2.9: Residues and potential uses

Source of the residues	Associated metals	Intermediate product or residue	Options for recycling or reuse
Raw material handling, etc.	All metals	Dust, sweepings	Feed for the main process
Smelting furnace	All metals	Slag	Return to smelting; construction material; abrasive industry; part of the slag may be used as refractory material, e.g. slag from the production of chromium metal
	Some ferro-alloys	Rich slag	Raw material for other ferro-alloy processes
Converting furnace	Cu	Slag	Recycle to smelter
Refining furnaces	Cu	Slag	Recycle to smelter
	Pb	Skimmings/dross	Recovery of other valuable metals
	Precious metals	Skimmings/dross and slag	Internal or external recycling
Slag treatment	Cu and Ni	Cleaned slag	Construction material, abrasives, drainage filling material, filler in cement production
		Matte	Metal recovery
Melting furnace	All metals	Skimmings/dross	Return to process after treatment
		Slag	Metal recovery
	Secondary Al	Salt slag	Metal, salt and oxide recovery
Electrorefining	Cu	Electrolyte bleed	Recovery of Ni
		Anode remnants	Return to converter
		Anode slime	Recovery of precious metals
Electrowinning	Zn, Ni, Co, PMs	Spent electrolyte	Reuse in leaching process
Fused salt electrolysis	Al	SPL	Carburant or disposal
		Excess bath	Sale as electrolyte
		Anode stubs	Recovery
	Na and Li	Cell material	Scrap iron after cleaning
Distillation	Hg	Residues	Reuse as process feed
	Zn, Cd	Residues	Return to ISF
Leaching	Zn	Ferrite residues	Disposal, reuse of liquor
	Cu	Residues	Disposal
	Ni	Cu/Fe residues	Recovery, disposal
Sulphuric acid plant		Catalyst	Regeneration, recycling or disposal
		Acid sludges	Metal recovery, disposal
		Weak acid	Leaching, decomposition, neutralisation, gypsum production
Furnace linings	All metals	Refractory	Use as slagging agent, disposal; reuse as a refractory
Milling, grinding	Carbon	Carbon and graphite dusts	Use as raw material in other processes
Pickling	Cu, Ti	Spent acid	Recovery

Dry abatement systems	Most metals (using fabric filters or ESPs)	Filter dust	Return to process; recovery of other metals
Wet abatement systems	Most metals (using scrubbers or wet ESPs)	Filter sludge	Return to process or recovery of other metals; disposal (e.g. Hg)
Waste water treatment sludge	Most metals	Hydroxide or sulphide sludges	Disposal, reuse
Digestion	Alumina	Red mud	Disposal, reuse of liquor

2.10 Decommissioning

Article 11(h) of the IED requires that the necessary measures be taken upon definitive cessation of activities to avoid any pollution risk and to return the site of operation to a satisfactory state. Soil and water protection are of major importance and the resuspension of soil and dust to air should be prevented so that they do not form diffuse emissions once an installation or part of an installation is closed [237, UBA (A) 2004]. An integrated approach means that at least the following measures are taken.

- Minimise the amount of soil that should be excavated or replaced due to construction and make sure that excavated soil material is treated carefully (in order to avoid harmful changes to soil properties).
- Minimise the input of substances into the soil by leakage, aerial deposition and inappropriate storage of raw materials, products or process residues during the operational phase of a facility.
- Assess historical contamination to take account of conditions prior to regulation to ensure a clean closure when a facility is shut down, e.g. clean-up and rehabilitation to allow future use of the area. Natural soil functions should be safeguarded, if feasible.

Site reports can be made at the earliest opportunity to establish a baseline against which further site contamination can be assessed. This baseline report can then be compared to later reports when the installation is sold, closed or redeveloped. The baseline report can also be used to prioritise action to be taken at the installation.

The remediation measures that could be taken are specific to individual sites, but could include intermediate cover, leachate collection, surface cover, removal of contaminated earth and the provision of geological barriers [237, UBA (A) 2004], [248, UBA (A) 2009].

For new plants, decommissioning should be considered at the design stage to prevent contamination. The UK Environment Agency has published a guide that describes the techniques to be used at the design stage so that decommissioning forms part of the total concept. The guide was prepared by the University of Bath [288, UK 2002]. The UK Environment Agency also requires operators of the activities listed in IED Annex I to submit a decommissioning plan to supplement their permits. For existing installations, the operator is asked to produce the plan as part of an Improvement Programme.

2.11 Safety Issues

Safety issues can be covered in a management system based on OHSAS 18001 or in an Integrated Management System standard such as PAS 99. The general policy for the prevention of, preparation for, and response to industrial accidents is based on the principles described below.

2.11.1 Prevention principle

The construction and operation of a plant should be carried out:

- in such a way as to prevent the uncontrolled development of abnormal operation;
- in such a way that the consequences of accidents are reduced;
- according to the best available safety techniques (state-of-the-art safety technology).

2.11.2 Consideration of complex systems in process industries

Complex systems can only be examined sufficiently by means of systematic, logical methods. This is taken into account by applying:

- systematic analytical investigation methods such as hazard and operability studies (HAZOP) or failure mode and effects analysis (FMEA);
- a detailed safety analysis considering the conditions of the individual case.

2.11.3 Appropriateness of means

Safety requirements are graded according to 'type and scope of hazards to be expected'. To this end, rules within Member States are usually set for:

- substances relevant to accidents (substance criteria, list of substances);
- industrial activities relevant to accidents (list of plants).

The relationship between the disaster potential and the quantity of hazardous substances is considered by a quantity threshold concept that defines different levels of safety requirements as a function of quantity.

2.12 General techniques to consider in the determination of BAT

This section describes techniques (or combinations thereof), and associated monitoring, considered to have the potential for achieving a high level of environmental protection in the activities within the scope of this document. The techniques described will include both the technology used and the way in which the installations are designed, built, maintained, operated and decommissioned.

It covers environmental management systems, process-integrated techniques and end-of-pipe measures. Waste prevention and management, including waste minimisation and recycling procedures are also considered, as well as techniques that reduce the consumption of raw materials, water and energy by optimising use and reuse. The techniques described also cover measures used to prevent or to limit the environmental consequences of accidents and incidents, as well as site remediation measures. They also cover measures taken to prevent or reduce emissions under other than normal operating conditions (such as start-up and shutdown operations, leaks, malfunctions, momentary stoppages and the definitive cessation of operations).

Annex III to the Directive lists a number of criteria for determining BAT, and the information within this chapter will address these considerations. As far as possible, the standard structure in Table 2.10 is used to outline the information on each technique, to enable a comparison of techniques and the assessment against the definition of BAT in the Directive.

This chapter does not necessarily provide an exhaustive list of techniques which could be applied in the sector. Other techniques may exist, or may be developed, which could be considered in the determination of BAT for an individual installation.

Table 2.10: Information for each technique

Headings within the sections
Description
Technical description
Achieved environmental benefits
Environmental performance and operational data
Cross-media effects
Technical considerations relevant to applicability
Economics
Driving force for implementation
Example plants
Reference literature

2.12.1 Environmental management systems

Description

A formal system to demonstrate compliance with environmental objectives.

Technical description

The Directive defines 'techniques' (under the definition of 'best available techniques') as 'both the technology used and the way in which the installation is designed, built, maintained, operated and decommissioned'.

In this respect, an environmental management system (EMS) is a technique allowing operators of installations to address environmental issues in a systematic and demonstrable way. EMSs are most effective and efficient where they form an inherent part of the overall management and operation of an installation.

An EMS focuses the attention of the operator on the environmental performance of the installation; in particular through the application of clear operating procedures for both normal and other than normal operating conditions, and by setting out the associated lines of responsibility.

All effective EMSs incorporate the concept of continuous improvement, meaning that environmental management is an ongoing process, not a project which eventually comes to an end. There are various process designs, but most EMSs are based on the plan-do-check-act cycle (which is widely used in other company management contexts). The cycle is an iterative dynamic model, where the completion of one cycle flows into the beginning of the next (see Figure 2.13).

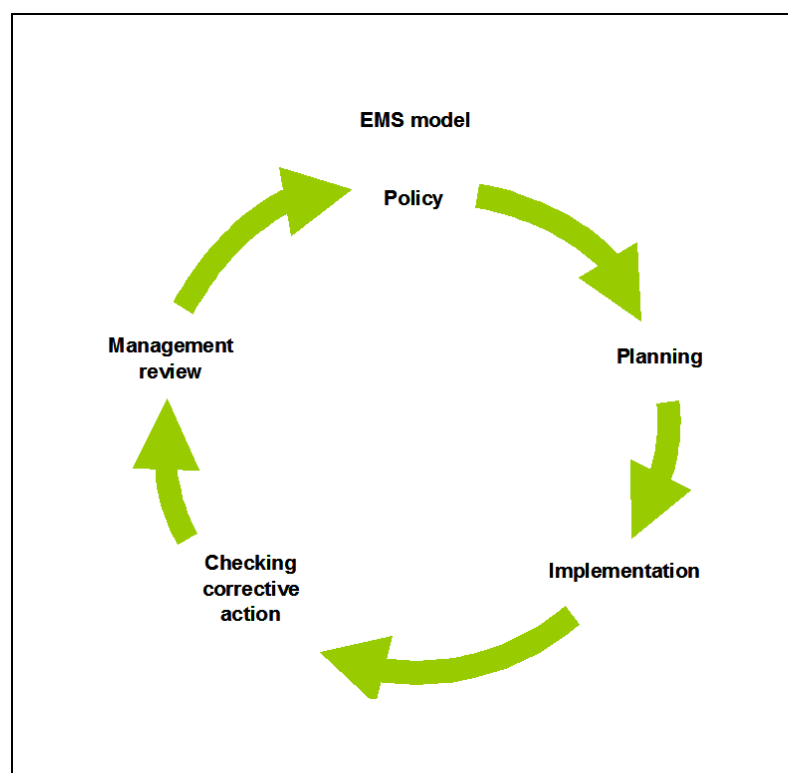

Figure 2.13: Continuous improvement in an EMS model

An EMS can take the form of a standardised or non-standardised ('customised') system. Implementation and adherence to an internationally accepted standardised system, such as EN ISO 14001:2015, can give higher credibility to the EMS especially when subjected to a properly performed external verification. EMAS provides additional credibility due to the interaction with the public through the environmental statement and the mechanism to ensure compliance with the applicable environmental legislation. However, non-standardised systems can, in principle, be equally effective provided that they are properly designed and implemented.

While both standardised systems (EN ISO 14001:2015 or EMAS) and non-standardised systems apply in principle to **organisations**, this document takes a narrower approach, not including all activities of an organisation, e.g. with regard to their products and services, due to the fact that the Directive only regulates **installations/plants**.

An EMS can contain the following components:

1. commitment of management, including senior management;
2. definition of an environmental policy that includes the continuous improvement of the installation by the management;
3. planning and establishing the necessary procedures, objectives and targets, in conjunction with financial planning and investment;
4. implementation of procedures paying particular attention to:
 - (a) structure and responsibility,
 - (b) recruitment, training, awareness and competence,
 - (c) communication,
 - (d) employee involvement,
 - (e) documentation,
 - (f) effective process control,
 - (g) maintenance programmes,
 - (h) emergency preparedness and response,
 - (i) safeguarding compliance with environmental legislation;
5. checking performance and taking corrective action paying particular attention to:
 - (a) monitoring and measurement (see also the Reference Report on Monitoring (ROM)),
 - (b) corrective and preventive action,
 - (c) maintenance of records,
 - (d) independent (where practicable) internal or external auditing in order to determine whether or not the EMS conforms to planned arrangements and has been properly implemented and maintained;
6. review of the EMS and its continuing suitability, adequacy and effectiveness by senior management;
7. preparation of a regular environmental statement;
8. validation by a certification body or an external EMS verifier;
9. following the development of cleaner technologies;
10. consideration for the environmental impacts from the eventual decommissioning of the installation at the stage of designing a new plant, and throughout its operating life;
11. application of sectoral benchmarking on a regular basis.

The set-up and implementation of an action plan on diffuse dust emissions (see BAT 5 ter) is also a part of the EMS.

Achieved environmental benefits

An EMS promotes and supports the continuous improvement of the environmental performance of the installation. If the installation already has a good overall environmental performance, an EMS helps the operator to maintain the high performance level.

Environmental performance and operational data

All significant consumption (including energy) and emissions are managed in a coordinated manner by the operator for the short, medium and long term, in conjunction with financial planning and investment cycles. This means for example that adapting short-term end-of-pipe solutions to emissions may tie the operator to long-term higher energy consumption, and postpone investment in potentially more environmentally beneficial solutions overall. This requires some consideration of the cross-media issues, and guidance on these and the costing and cost-benefit issues is given in the Reference Document on Economics and Cross-Media Effects [336, EC 2006] and in the BREF on Energy Efficiency. [333, EC 2008]

Cross-media effects

None reported. The systematic analysis of the initial environmental impacts and scope for improvements in the context of the EMS sets the basis for assessing the best solutions for all environmental media.

Technical considerations relevant to applicability

The components described above can typically be applied to all installations within the scope of this document. The scope (e.g. level of detail) and nature of the EMS (e.g. standardised or non-standardised) will be related to the nature, scale and complexity of the installation, and the range of environmental impacts it may have.

Economics

It is difficult to determine accurately the costs and economic benefits of introducing and maintaining a good EMS. There are also economic benefits that are the result of using an EMS and these vary widely from sector to sector.

External costs relating to verification of the system can be estimated from guidance issued by the International Accreditation Forum [417, IAF 2010].

Driving forces for implementation

The driving forces for the implementation of an EMS include:

- improved environmental performance;
- improved insight into the environmental aspects of the company which can be used to fulfil the environmental requirements of customers, regulatory authorities, banks, insurance companies or other stakeholders (e.g. people living or working in the vicinity of the installation);
- improved basis for decision-making;
- improved motivation of personnel (e.g. managers can have confidence that environmental impacts are controlled and employees can feel that they are working for an environmentally responsible company);
- additional opportunities for operational cost reduction and product quality improvement;
- improved company image;
- reduced liability, insurance and non-compliance costs.

Example plants

EMSs are applied in a number of installations throughout the EU.

Reference literature

[333, COM 2009], [336, COM 2006], [417, IAF 2010], [420, EC 2009], [430, CEN 2015].

2.12.2 Energy management

Apart from the techniques listed below, the techniques described in Section 2.2.1 are also techniques to consider.

2.12.2.1 Use of oxygen enrichment in combustion air**Description**

Oxygen enrichment is used to allow the autothermal oxidation of sulphide-based ores, to increase the capacity or melting rate of particular furnaces and to provide discrete oxygen-rich areas in a furnace to allow complete combustion separately from a reducing zone.

Technical description

Oxygen enrichment of the combustion air is frequently used in the production processes for non-ferrous metals. The processes use tonnage oxygen directly or in the furnace body.

The use of oxygen can give both financial and environmental benefits provided that the plant can accommodate the extra heat released. There is a possibility that higher concentrations of

nitrogen oxides can be produced with oxygen enrichment, but the associated reduction in gas volume usually means that the mass is reduced. This is covered in more detail in the relevant metal chapters.

Achieved environmental benefits

Prevention of metals, dust and other compounds emissions to air.

Environmental performance and operational data

Oxygen enrichment can achieve the following improvements.

- An increase in the heat released in the furnace body which allows an increase in the capacity or melting rate and a reduction in the quantity of fuel used, with the associated reduction in greenhouse gas emissions. It is possible to operate some processes autothermally and to vary the extent of oxygen enrichment 'on-line' to control the metallurgical process and prevent emissions.
- A significant reduction in the volume of process gases produced, as the nitrogen content is reduced, which allows a significant reduction in the size of downstream ducts and abatement systems and prevents the loss of energy otherwise needed to heat the nitrogen.
- An increase in the concentration of sulphur dioxide (or other products) in the process gases, which allows conversion and recovery processes to be more efficient without using special catalysts.
- The use of pure oxygen in a burner leads to a reduction in the partial pressure of nitrogen in the flame, and therefore thermal NO_x formation may be reduced.
- The production of tonnage oxygen on site is associated with the production of nitrogen gas separated from the air. This is used occasionally for inert gas requirements on site. Inert gases are used for abatement systems when pyrophoric materials are present (e.g. dry Cu concentrates), for degassing molten metal, for slag and dross cooling areas, and for fume control of tapping and pouring operations.
- The injection of oxygen at discrete points in a furnace downstream of the main burner allows temperature and oxidising conditions to be controlled in isolation from the main furnace operations. This allows the melting rate to be increased without an unacceptable increase in temperature. An example is the provision of an integral afterburning zone in a blast furnace.

Cross-media effects

No information provided.

Technical considerations relevant to applicability

This is a technique that can be applied to most of the combustion and pyrometallurgical processes in use. The full benefit is best achieved with new plants, where the combustion chamber and abatement systems can also be designed for lower gas volumes. The technique is also applicable to existing plants though and can in many cases be retrofitted.

For furnaces that use raw materials containing sulphur or carbon, the use of oxygen-enriched air or pure oxygen in the burners could allow autogenous smelting or the complete combustion of carbonaceous material.

Economics

Some data on costs involved in oxy-fuel firing for secondary aluminium production are given in Table 2.11.

Gas consumption savings of EUR 12/t are reported which, on the basis of an expected production of 13 500 t/yr (one furnace), represents an annual saving of EUR 152 000. Oxygen consumption represents an additional cost of EUR 12/t, which represents an annual cost of EUR 152 000.

The economic advantages are therefore mainly related to improvements in terms of the production rate. In 1999, the fixed costs were around EUR 145/t for two furnaces (22 561 tonnes produced/year). The higher productivity allowed by using oxy-fuel burners would result in a cut in these costs to around EUR 122/t ($22\,561 \times 145/27\,000$). There is therefore a potential saving of EUR 23/t for a production rate of 27 000 t/yr.

Table 2.11: Techno-economic comparison of an oxy-fuel burner compared to an air-fuel burner

Parameter	Benefits/costs	Comment
Melting time	- 2.45 h/charge	Reduced batch melting time
Productivity	+ 0.84 t/h	Increased productivity of the furnace
Gas consumption	- 80 m ³ /t (tonne of oxygen)	Reduced consumption of gas
O ₂ consumption	+ 126 m ³ /t	Additional consumption of oxygen

Driving force for implementation

- Reduction of emissions.
- Energy savings.

Example plants

Plants in DE, AT, FR, BE and UK.

Reference literature

[122, ETSU 1994], [276, Schmitt G. 2008], [103, COM 1998].

2.12.2.2 Use of a regenerative burner

Description

In a regenerative burner, exhaust gas and combustion air alternately flow through a chamber filled with a heat storage medium; charging with the exhaust gas flow and discharging with the airflow.

Technical description

Regenerators, if constructed from materials which will accept the full exhaust gas temperature from the fired chamber and resist any corrosive elements contained therein, display none of the difficulties usually seen for recuperators.

A twin bed regenerative burner consists of an entirely ceramic high-temperature burner close coupled to a compact, fast-cycle, ceramic regenerator. The burner serves two purposes, acting as the inlet or the exhaust from the fired chamber depending on the cycle. One complete twin bed regenerative burner set comprises two burners, two regenerators, reversing valves and a control system.

- While one of the burners fires using cool air fed to the base of its regenerator, exhaust gas is drawn through the other burner and down into its associated regenerator to preheat the packing, then is discharged to the gas-cleaning plant. When the regenerator being heated is sufficiently charged, the airflow is reversed so that cool air flows to the newly heated regenerator and is preheated, the previously cooled regenerator being reheated by the exhaust gas generated by the other burner firing. The first and second halves of the cycle are shown in Figure 2.14 and Figure 2.15.

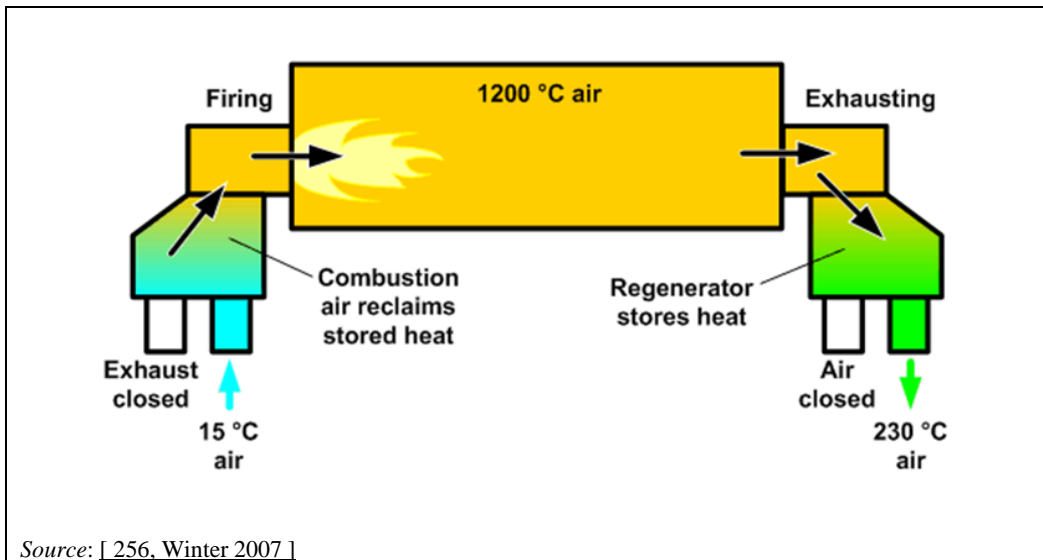

Figure 2.14: First half of the regenerative burner cycle

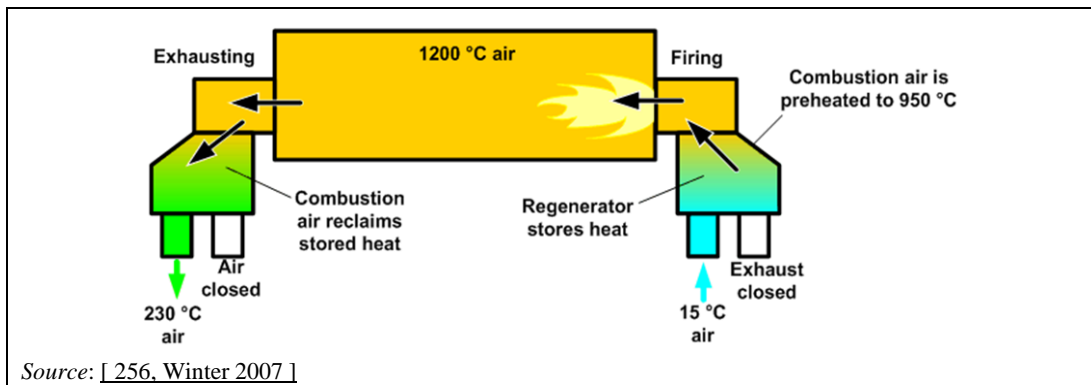

Figure 2.15: Second half of the regenerative burner cycle

Achieved environmental benefits

The energy content of the hot gases is used to heat the support materials and can reduce the energy consumption by 70 % compared to that of a normal burner. Regenerative burners are reported to use 30 % less energy than recuperative burners.

Environmental performance and operational data

Regenerative burners are used in a number of applications. The process depends on an alternating cycle of gases through a series of support zones using ceramic balls where heating and cooling cycles take place. Combustion air can be preheated to approximately 900 °C.

Cross-media effects

None reported.

Technical considerations relevant to applicability

This technique is applicable to a variety of new and existing processes. Additional post-treatment of the gases might be required depending on input material.

Economics

The payback time for regenerative burners in the secondary aluminium sector is reported to be less than one year.

Driving force for implementation

Improved energy efficiency.

Example plants

Plant in Austria.

Reference literature

[103, COM 1998], [256, Winter 2007]

2.12.2.3 Use of a regenerative afterburner**Description**

A combustion system that employs a regenerative process to utilise the thermal energy in the gas and carbon compounds by using refractory support beds. A manifold system is needed to change the direction of the gas flow to clean the bed.

Technical description

Regenerative afterburners, also known as regenerative thermal oxidisers (RTOs), serve to treat the off-gases. The process depends on an alternating cycle of gases through a series of support zones where heating, cooling and cleaning cycles take place. The combustible fraction is heated in the heating zone and passes to a common residence chamber where combustion is completed. The hot gases then pass into a cooling section, which is heated to become the next heating zone. The zones are changed using a manifold system to allow cleaning.

A regenerative afterburner is shown in Figure 2.16.

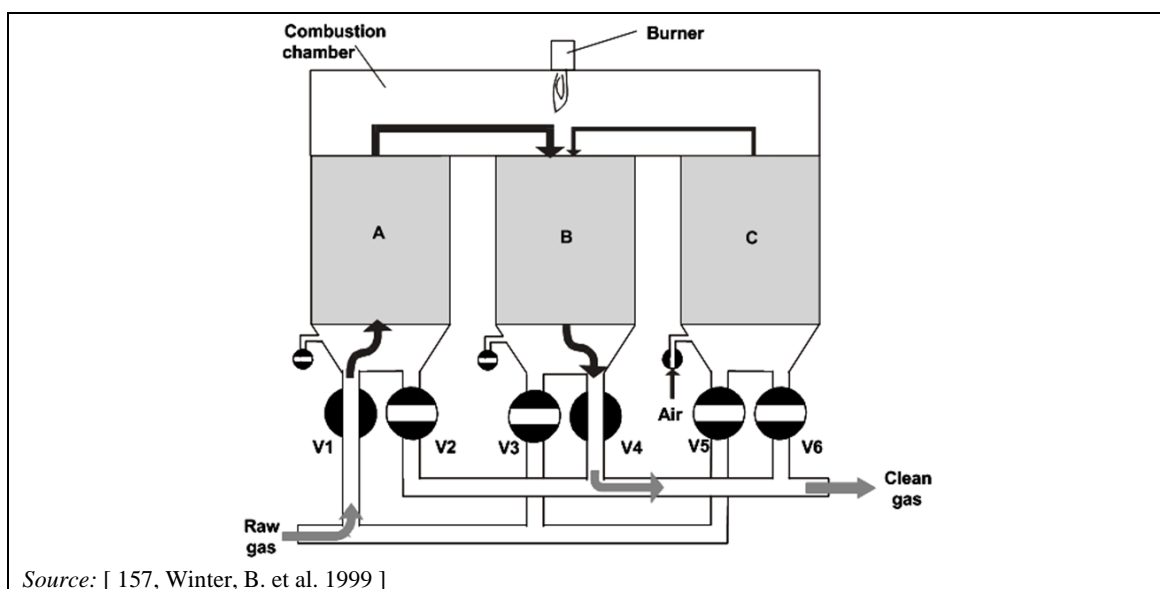

Figure 2.16: Regenerative afterburner

Achieved environmental benefits

The energy content of the hot gases and of the contaminants (hydrocarbons and PAH) is used to heat the support materials, and can thus reduce energy consumption by 70 % compared to that of a normal afterburner.

Environmental performance and operational data

Regenerative burners or afterburners are used in a number of applications. The process depends on an alternating cycle of gases through a series of support zones using ceramic chips where heating and cooling cycles take place. Combustion air can be preheated to approximately 900 °C. Emission levels associated with RTO performance can be found in the metal-specific chapters.

Cross-media effects

Increases in PCDD/F concentrations have been reported for a regenerative afterburner installation serving a blast furnace. This is thought to be due to the longer residence time of gases in the de novo synthesis temperature range.

Technical considerations relevant to applicability

This technique is applicable to a variety of processes when the abatement of a combustible pollutant is required. The basic principle is good but the changeover to the cleaning phase and longer residence time of gases in the de novo synthesis temperature range may cause the emission of uncombusted material if the design is poor. Additional pre- and post-treatment of the gases might be required for the regenerative afterburner.

Economics

No information provided but several installations are operating economically.

Driving force for implementation

Reduction of emissions of TVOC, PAH and PCDD/F, and improved energy efficiency.

Example plants

Plants in AT, DE, UK and NL.

Reference literature

[103, COM 1998], [157, Winter, B. et al. 1999], [242, Infomil 2008].

2.12.2.4 Use of low-grade heat

Description

All pyrometallurgical processes produce heat either as hot gases or hot water. The options to recover low-grade heat have always been a difficult issue as they are limited. It is possible to recover heat from liquids at a temperature of about 55 °C, and two examples have been reported.

Technical description

The first example is the use of water from the spray cooling of metallurgical slag, which is collected in a sump and passed through a heat exchanger to heat a circuit that uses ethylene glycol. Users of low-grade heat can extract heat from the circuit through another heat exchanger [233, COM 2008].

In the second example low-grade heat is used to generate electrical power, and this provides the opportunity to produce electricity from heated waste water with temperatures of 85 °C and above.

Achieved environmental benefits

Recovery of heat and the prevention of emission of heat.

Environmental performance and operational data

The heat is exchanged and transferred into a closed loop, comprising a carrier fluid that expands and drives a turbine which in turn drives a generator, see Figure 2.17. The generator normally provides electrical power.

Small-capacity power plants use two container-mounted units. They are 12.2 metres in length, 2.3 metres in width, and 3.0 metres in height, with a gross weight of 25 tonnes.

The containers are equipped with connections to heat waste water flow lines, as well as connections to the inlet of required cooling water. The containers furthermore house the required appliances for connecting to existing power distribution grids. Larger plants can be constructed on site or alternatively may be established through the required number of container units connected in parallel.

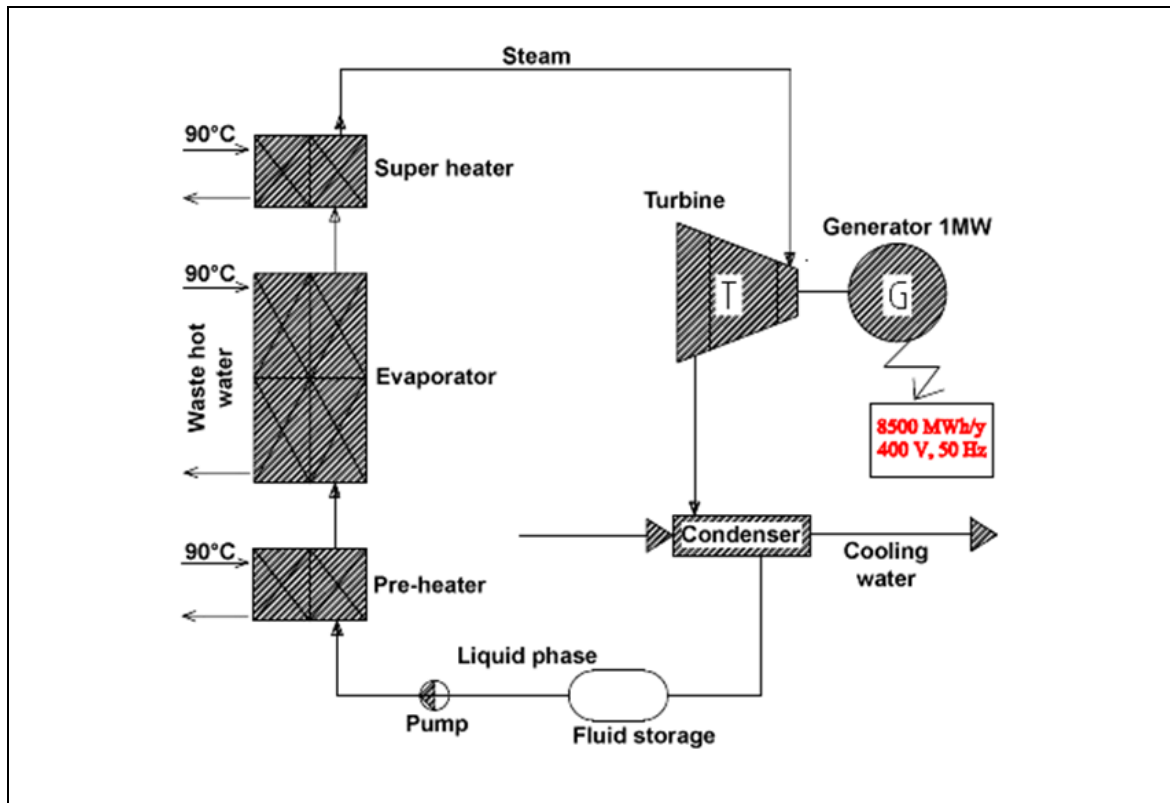

Figure 2.17: Electricity generation from low-grade heat

Cross-media effects

No information provided.

Technical considerations relevant to applicability

This technique is applicable to a variety of processes.

Economics

No information provided but several installations are operating economically.

Driving force for implementation

Improved energy efficiency.

Example plants

Plants in Norway.

Reference literature

[233, COM 2008]

2.12.2.5 Use of waste as a fuel or reducing agent

Conventional fuels or reducing agents can be replaced by waste materials. Different types of waste are used as fuels or reducing agents in the non-ferrous metals industries. Since this technique involves the incineration of waste, the installation should comply with the Waste Incineration Directive (2000/76/EC).

Waste can often only be used after certain pretreatment stages to provide tailor-made fuels for the burning process. Since waste treatment operations are not covered by this document, more useful information can be found in the Waste Treatment Industries BREF [341, EC 2006].

Description

Selected wastes with recoverable net calorific values such as waste oil, solvents and plastics can be used as fuels, replacing conventional fossil fuels, provided that they meet certain specifications and characteristics. Different criteria play a decisive role in the selection of waste fuels as they can have an impact on kiln operation and on emissions.

To guarantee the characteristics of the waste fuel, a quality assurance system is required. In particular this should include provisions for sampling, sample preparation, analysis and external monitoring. More useful information can be found in the technical specifications of the European Committee for Standardisation, such as CEN/TC 343 'Solid recovered fuels'.

Achieved environmental benefits

The selection of waste fuels is driven by a number of interrelated considerations, including the following main points:

- the reduction of emissions, e.g. CO₂, derived from fossil fuels;
- the reduction in the use of natural resources, e.g. fossil fuels;
- the reduction of transportation distances;
- the avoidance of disposal to landfill;
- a safe recovery route for waste.

Cross-media effects

Depending on their characteristics, e.g. high metal concentrations, waste fuels may have an effect on emissions.

Operational data

The study 'Assessment of the application and possible development of community legislation for the control of waste incineration and co-incineration' identified six plants in the non-ferrous metals industry that use waste as a fuel. The study was conducted on behalf of the European Commission by Ökopol in 2007 [315, Okopol 2007].

Wastes that are used as fuel in the non-ferrous metals industry have a high net calorific value, e.g. waste oil with a net calorific value of 37 MJ/kg and solvents with a net calorific value of 26 MJ/kg.

In a rotary kiln of a nickel roasting plant in Austria, conventional fuels are replaced by waste oil and solvents.

Applicability

These fuels can, in principle, be used where complete combustion of organic matter is assured, and waste input control and emissions control guarantee a low level of emissions, e.g. metals and dioxins.

Economics

In comparison to the use of fossil fuels, the use of waste fuels can reduce operational costs.

Driving force for implementation

Reduction of fuel costs and availability of resources.

Example plants

Plants in Austria.

Reference literature

[311, Mauschitz 2007], [315, Okopol 2007].

2.12.3 Monitoring and process control**2.12.3.1 Process control techniques****Description**

Set of techniques to control the process and support a smooth and stable process operation.

Technical description

Process operation and control is applied to a variety of processes. The main techniques are described below.

- Inspection and selection of input materials according to the process and abatement techniques applied. Typical procedures include (most in written form):
 - o verification of the shipping papers;
 - o visual verification that the delivered material is the same as specified in the contract and is in accordance with the accompanying shipping documents;
 - o determination of mass;
 - o Inspection of the delivered material to identify if any foreign substances are present which could impact on the environment or plant equipment, or which are suspected to cause health and safety problems:
 - visual inspection,
 - random check analysis, depending on type of material,
 - radioactivity test;
 - o acceptance (or rejection) of input materials;
 - o allocation to a storage area;
 - o unloading check and cleaning of transport vehicles, where required;
 - o if needed and possible:
 - sorting of foreign substances: return to supplier or appropriate disposal,
 - appropriate processing – if necessary 'adaptation' process;
 - o taking representative samples to determine chemical composition (by analytical assay or by 'grading') for technical or commercial purposes.
- Good mixing of different feed materials should be achieved for optimum process performance, higher conversion efficiency, reduced emissions to all environmental media, reduced energy use, increased quality and reduced level of reject products. Small-scale pot furnaces are used to identify the correct raw material mixtures. Fluctuations in the moisture content of the feed of a furnace can cause process gas volumes that are too large for the designed aspiration capacity, resulting in diffuse emissions.
- Feed weighing and metering systems are used extensively. Loss-in-weight silos, belt weighers and scale weighers are widely used for this purpose.
- Processors are used to control material feed rate, critical process and combustion conditions, and the additions of gases. Several parameters listed below are measured to allow processes to be controlled, and alarms are used for critical parameters:
 - o on-line monitoring of temperature, furnace pressure (or depression) and gas volume or flow;
 - o gas components (O₂, SO₂, CO);

- o on-line monitoring of vibration to detect blockages and possible equipment failure;
 - o on-line monitoring of the current and voltage of electrolytic processes;
 - o on-line monitoring of emissions to control critical process parameters;
 - o on-line monitoring of acid strength and metal concentrations;
 - o on-line monitoring of parameters for hydrometallurgical processes (e.g. pH, redox potential, temperature);
 - o sampling and analysis of intermediate and end solutions in hydrometallurgical processes.
- Monitoring and control of the temperature in the melting furnaces to prevent the production of metal and metal oxide fumes by overheating.
 - Monitoring and control of the temperature of electrolytic cells to identify hot spots that indicate short circuiting in the cell.
 - The oxygen coefficient of a furnace can be automatically controlled by a mathematical model that predicts the changes in the composition of the feed and furnace temperatures; the model can be based on more than 50 process variables. In the primary aluminium industry, mathematical models are also used in conjunction with monitoring of cell operating conditions to prevent anode effects. An 80 % reduction in polyfluorocarbon (PFC) emissions has been achieved since 1990 according to one report [299, COM 2007]. In primary zinc production, an automatic control system in the roasting process is used to increase the bed stability and decrease operational problems, diffuse emissions and shutdowns.
 - Process gases are collected using sealed or semi-sealed furnace systems. Interactive variable speed fans are used to ensure that optimum gas collection rates are maintained and to minimise energy costs.
 - Solvent vapours are collected and recovered as far as possible using sealed reactors or local vapour collection in combination with chillers or condensers. Further removal and incineration of solvent vapours is practised to prevent the emission of VOCs and odours.
 - Operators, engineers and others should be regularly trained and assessed in the use of operating instructions, the use of the modern control techniques described and the significance of alarms and the actions to be taken when they go off.
 - Levels of supervision are optimised to take advantage of the above, while maintaining operator responsibility.
 - Environmental management and quality systems are used.
 - Hazard and operability studies are carried out at the design stages for all process changes.
 - Robust maintenance systems are used, including a growing use of dedicated maintenance staff as part of the operator teams, and supplementing dedicated maintenance teams.
 - Process design aspects are described in various sections of this document, as they are commonly used in this sector. Full process design is approached with care by professional engineers who have experience and knowledge of the process and of the environmental impact and requirements.
 - Slag, metal and matte are analysed on the basis of samples taken at intervals, so that the use of fluxes and other raw materials can be optimised, the metallurgical process conditions can be determined, and the metal content of the materials agreed upon.
 - For some processes, special regulations such as the Seveso or Waste Incineration Directives may have to be taken into account.

Achieved environmental benefits

Prevention of metals, dust and other compounds emissions to air.

Environmental performance and operational data

No operational data have been reported but more information is available in the metal-specific chapters.

Cross-media effects

None reported.

Technical considerations relevant to applicability

These techniques are generally applicable to most plants.

Economics

No information provided but the processes are known to be operating economically.

Driving force for implementation

- Reduction of emissions.
- Raw material savings.
- Smooth operating process.

Example plants

Plants in DE, AT, FR, BE, PL and NL.

Reference literature

[299, COM 2007] [196, Finkeldei, L. 1999].

2.12.3.2 Design and control techniques for an abatement plant**Description**

Set of techniques to support an appropriate functioning of the air emissions abatement plant.

Technical description

The choice and design of a suitable abatement technique is particularly important. Several techniques exist and, although some may seem to offer a very high performance, problems may be encountered unless characteristics such as the loading and nature of the gases, dust, and other components are fully considered. For example, a fabric filter using modern materials is considered to offer a better environmental performance than other techniques for dust removal; however, it cannot be considered to be universally applicable due to problems of stickiness and abrasion with some types of dust. These issues are specific to individual sites and materials and the operator should consider these factors in a professional design brief.

The volume, pressure, temperature and moisture content of the gas are important parameters and have a major influence on the techniques or combination of techniques used. In particular, the dew point will be affected by all of these parameters, and variations throughout a production cycle should be taken into account.

The characterisation of the nature of the dust or fume is very significant, so it is important to identify any unusual properties in the dust (hygroscopic, pyrophoric, sticky, abrasive, etc.). The particle size and shape, wettability and density of the material are also factors to optimise the choice of technique. The dust concentration and its variability should also be taken into account for producing a reliable, robust design.

Many operators have identified that performance may deteriorate over time as equipment wears and maintenance is needed. Modern systems should be used, if required, to continuously monitor performance by direct measurement of the gases emitted (e.g. for dust, CO, SO₂). For example, dust can be monitored using an electrodynamic technique. This is a technique based on a charge induction principle derived from particle interaction with a probe inserted into a stack or duct. Alternatively, critical control parameters can be monitored. Alarm systems should be incorporated into these systems.

The following techniques are techniques to consider:

- Use of reagent metering systems.
- Use of a processor control of reagent feed and plant performance. On-line monitoring can include temperature, pressure drop, dust or other pollutants emitted, ESP current and

voltage, scrubbing liquid flow and pH. Alarms are provided to indicate operational problems.

- Training and assessment of operators in the use of operating instructions and the modern control techniques described.
- Optimisation of levels of supervision to take advantage of the above, but maintaining operator responsibility.
- Use of environmental management and quality systems.
- Use of predictive or other mathematical models to assess trends in operating conditions, for example in the copper and aluminium industries, to prevent emissions or to optimise the process.
- Use of robust maintenance systems, including a growing use of dedicated maintenance staff as part of the operator teams.
- Use of routines to check the reliability of weighing systems.
- Use of filter bag burst detection based on the interface between the dust monitor and the cleaning cycle.
- Use of small furnaces to smelt samples of the raw materials, so that optimum blends of raw materials and fluxes can be identified and the optimum furnace operation established. This technique is also used to determine the content of metals in each consignment, so that purchase prices can be agreed upon.

Good process control is used to achieve these gains and also to maintain safe conditions and to analyse past events and process responses. The implementation of a capable process control system is required for all modern non-ferrous smelting and operating processes; without a good process control system, an operation cannot be considered to be BAT.

There are a number of cases (e.g. blast furnaces) where the development and use of modern process controls is needed. More work is needed to identify the relevant control parameters and systems.

Achieved environmental benefits

Prevention of metals, dust and other compounds emissions.

Environmental performance and operational data

No information provided.

Cross-media effects

Increase in energy use.

Technical considerations relevant to applicability

Generally applicable.

Economics

The processes are operating economically and costs, where they are available, are reported in Annex 13.3 of this document.

Driving force for implementation

- Reduction of emissions.
- Possible raw material savings.

Example plants

Plants in DE, AT, FR, BE and PL.

Reference literature

[226, Nordic Report 2008], [103, COM 1998].

2.12.3.3 Process control techniques for effluent treatment

Description

Set of techniques to support an appropriate functioning of the effluent treatment plant.

Technical description

The following techniques are techniques to consider [103, COM 1998].

- Reagent metering systems.
- Processor control of reagent feed and plant performance. On-line monitoring can include (depending on the relevance of the process): temperature, turbidity, pH, conductivity, redox, TVOC, individual metals and flow.
- Environmental management and quality systems, including (see also Section 2.12.1):
 - training and assessment of operators in the use of operating instructions and the use of the modern control techniques described;
 - optimisation of levels of supervision to take advantage of the above, while maintaining operator responsibility;
 - use of robust maintenance systems, including a growing use of dedicated maintenance staff as part of the operator teams.

Achieved environmental benefits

Prevention of metals, suspended solids and other compounds emissions.

The composition of the liquid effluents from pyrometallurgical and from hydrometallurgical methods depends very much on the metal being produced, the production process and the raw material that is used. However, the liquid effluents from a non-ferrous metal production plant normally contain metals, e.g. copper, lead, zinc, tin, nickel, cadmium, chromium, arsenic, molybdenum, mercury and suspended solids.

Environmental performance and operational data

The most important factors to minimise the amount of waste water and the concentration of the pollutants are:

- the process where the waste water is generated;
- the amount of water;
- the pollutants and their concentrations;
- the level of clean-up required, i.e. local or regional water quality standards;
- the availability of water resources.

Cross-media effects

There is the potential to produce a waste for disposal.

Technical considerations relevant to applicability

Generally applicable.

Economics

No information provided but the processes are known to be operating economically.

Driving force for implementation

- Prevention of emissions.
- Raw material savings.

Example plants

Plants in DE, AT, FR, BE and PL.

Reference literature

[166, Clark, J.H. 1995].

2.12.4 Diffuse emissions

The techniques involved for abating diffuse emissions follow as far as possible the hierarchy of prevention, minimisation and the collection of fumes nearest to the source. An assessment of potential sources of diffuse emissions should lead to an action plan within the environmental management system (EMS). This assessment should also take into account the resuspension of dusty materials from abandoned workings, storage areas or disposal points due to wind action and vehicle movements.

An action plan on diffuse emissions may incorporate the following features:

- analysis and measurement of the actual emission sources and estimation of the total diffuse emissions (e.g. EN 15445);
- identification of appropriate actions and techniques to reduce diffuse emissions;
- elaboration of an emission minimisation plan, if needed, according to the results of the previous steps;
- implementation of the minimisation plan and monitoring of the results on a yearly basis.

2.12.4.1 Techniques to prevent diffuse emissions from raw material storage, handling and transport

Description

Set of techniques to prevent diffuse emissions from raw material storage, handling and transport.

Technical description

The applied techniques discussed in Section 2.4.2 are capable of preventing emissions to all environmental media to a certain extent. The techniques that are used largely depend on the type of material that is being used. For example, large, heavy items are treated by a completely different range of techniques to fine, dusty material. These issues are specific to individual sites and materials. There are, however, many general techniques that are considered more effective in preventing emissions from raw material storage, handling and transport, as detailed below.

- Use of enclosed buildings or silos/bins for the storage of dust-forming materials, such as concentrates, fluxes and fine materials.
- Covered storage for dust-forming materials such as concentrates, fluxes, solid fuels and coke and secondary materials that contain water-soluble organic compounds.
- Sealed packaging for the storage of dust-forming materials or secondary materials that contain water-soluble organic compounds.
- Covered bays for the storage of materials that have been pelletised or agglomerated.
- Use of water sprays to suppress dust or alternative methods, such as fog sprays, to create fine water mists for dust suppression without over-wetting the material. The use of water sprays is not applicable for processes that require dry materials or for ores/concentrates that naturally contain sufficient water to prevent dust formation. The application is also limited in regions with water shortages or with very low winter temperatures. Sealing agents such as molasses and polyvinyl acetate (PVA) should be used where appropriate and compatible, to reduce the tendency of material to form dust.
- Liquid storage systems should be contained in impervious bunds that have a capacity capable of containing at least the volume of the largest storage tank within the bund.
- Storage areas should be designed so that leaks from the tanks and from delivery systems are intercepted and contained in the bund.

- The materials used for the construction of the tanks should be resistant to the materials stored. In some cases, double-walled tanks are appropriate.
- Leak detection systems should be used where appropriate.
- Tank contents should be displayed and associated alarms that indicate leaks should be used. Planned deliveries and automatic control systems to prevent the overfilling of storage tanks should also be used.
- The storage of sulphuric acid and other reactive materials should be carried out in double-walled tanks or tanks placed in chemical-resistant bunds of the same capacity. If there is a risk of groundwater contamination, the storage area should be impermeable and resistant to the material stored.
- Delivery points should be contained within the bund to collect spilled material. Displaced gases should be back-vented to the delivery vehicle to reduce the emission of VOCs. Automatic resealing of delivery connections should be used to prevent spillages.
- Incompatible materials are segregated (e.g. oxidising agents and organic materials), and inert gases should be used for storage tanks or areas if needed.
- Oil and solids interceptors are used for drainage from open storage areas. The storage of material that can release oil should be on concreted areas that have curbs or other containment devices. Effluent treatment methods for the chemical species that are stored should be used.
- Transfer conveyors and pipelines are placed in safe, open areas above ground, so that leaks can be detected quickly and damage from vehicles and other equipment can be prevented.
- If buried pipelines are used for non-hazardous materials, their course should be documented and marked, and safe excavation systems adopted.
- Well-designed, robust pressure vessels for gases (including LPG) should be used with pressure monitoring of the tanks and delivery pipework to indicate ruptures or leakages. Gas monitors should be used in confined areas and close to storage tanks.
- Enclosed conveyors or pneumatic transfer systems should be used for the transportation of fine and dusty materials with well-designed, robust extraction and filtration equipment to prevent the emissions of dust from delivery points, silo vents, pneumatic transfer systems and conveyor transfer points where dust emissions are possible. Covered conveyors could be used for non-dust-forming materials. When using open belt conveyors, the speed should be adjusted (< 3.5 m/s).
- Dusty material can also be transported in closed containers or other closed recipients. Emptying of recipients/containers takes place in a closed system with a vent system and air filtration by a bag filter. Materials with dispersible or water-soluble components are handled in closed bags or drums. Non-dusty materials are delivered and handled in bulk.
- Non-dusty, insoluble material should be stored on impervious and sealed surfaces such as concrete to prevent soil contamination, with drainage and drain collection.
- Swarf, turnings and other oily material should be stored under cover to prevent them being washed away by rainwater.
- Rationalised material transfer systems should be used to minimise the generation and transport of dust between processes and within a site. Rainwater that washes dust away should be collected and treated before discharge.
- Use of an enclosed tipping area for unloading of trucks or railway cars.
- Wheel and body washes or other cleaning systems should be used to clean vehicles used to deliver or handle dusty material. Local conditions, e.g. ice formation, will influence the method. Planned campaigns for road sweeping should be used.
- Wet road cleaning or other specialised equipment using a combination of water jets and vacuum collection can be used to remove deposited dust from traffic and handling areas to clean and prevent resuspension of dust.
- Inventory control and inspection systems should be used to prevent spillages and identify leaks.
- Material sampling and assay systems should be integrated into the material handling and storage system where possible, to identify raw material quality and plan the processing

method. These systems should be designed and operated to the same high standards as the handling and storage systems.

- Storage areas for reducing agents such as coal, coke or woodchips should be surveyed to detect fires caused by self-ignition.
- Good design and construction practices should be used and adequate maintenance practised.

For the outdoor storage of raw materials, the following techniques should also be considered, depending on their tendency to emit dust.

- Regular moistening of the heap surface with water, or the use of dust-binding substances, or covering with tarpaulins.
- Use of sealing agents such as molasses and polyvinyl acetate on fine materials stored outdoors, to reduce the tendency of material to form dust.
- Placing the longitudinal axis of the heap parallel to the prevailing wind direction.
- Use of protective planting, windbreak fences or upwind mounts to lower the wind speed.
- Use of one heap instead of several, where feasible.
- Use of retaining walls to form bays.
- Collection of surplus sprinkling water and rainwater and connection to a sewage system.
- Regular cleaning of the storage area and, when needed, moistening with water.
- Use of oil and solids interceptors for drainage from open storage areas. The storage of material that can release oil, such as swarf, should be on concreted areas that have curbs or other containment devices.

Achieved environmental benefits

Prevention of diffuse metals, dust and other compounds emissions.

Environmental performance and operational data

No information provided.

Cross-media effects

Increase in energy use for operation of exhaust and filtration systems such as fans and bag filters.

If water is added to moisten the material, there may be a significant increase in energy consumption in the smelting process. The added water remains in the material and needs to be removed in the dryer or furnace during processing. This requires additional energy.

Treatment of large volumes of air and high energy consumption particularly associated with the roof extraction systems. Because of the relatively low dust load of the exhaust air, building filtration systems operate at a lower efficiency.

Water consumption for moistening materials, sprinkling roads, and wheel wash installation.

Technical considerations relevant to applicability

Generally applicable.

Economics

No information provided but the processes are operating economically.

Driving force for implementation

- Prevention of emissions.
- Raw material savings.

Example plants

Plants in DE, AT, FR, BE, PL and NL.

Reference literature

[196, Finkeldei, L. 1999], [290, EC 2006].

2.12.4.2 Techniques to prevent diffuse emissions from the pretreatment of raw materials**Description**

Set of techniques to prevent diffuse emissions from the pretreatment of raw materials.

Technical description

The techniques that are used depend to a large extent on the type of material that is being used. For example, large, heavy items are treated by a completely different range of techniques to fine, dusty material. These issues are specific to individual sites and materials. The preprocessing and transfer operations however often deal with materials that are dry or are likely to produce process emissions to any of the environmental media. A more detailed design of the process equipment used at this stage is therefore needed and the processes need to be monitored and controlled effectively. The nature of the material (e.g. dust-forming, pyrophoric) should be taken into account in the assessment of potential sources of diffuse emissions. Extraction and abatement systems in particular need to be carefully designed, constructed and maintained. The review of applied techniques in this section includes the issues that will be encountered in the various process options. The emissions of VOCs and PCDD/F in thermal processes should also be assessed as contamination of the raw materials is a significant potential source of these emissions, and so pretreatment is a technique to consider in order to reduce them. The techniques listed above for raw material handling (see Section 2.12.4.1) should also be referred to.

The following techniques, however, are considered to be the most important general techniques.

- The use of pretreatment and transfer processes with well-designed robust extraction and abatement equipment to prevent emissions of dust and other material. The design of this equipment should take into account the nature of the emissions, the maximum rate of emission and all the potential sources.
- Thermal or mechanical pretreatment to minimise organic contamination of the furnace feed.
- If required to minimise the generation of smoke and fumes and to improve the melting rates, separation processes should be designed to produce materials that are suitable for the subsequent processes.
- The collection and treatment of liquid effluents before discharge from the process to remove non-ferrous metals and other components.
- The use of good design and construction practices and adequate maintenance.

The following pretreatment techniques are considered metal-specific and will be further described in the metal-specific chapters.

- The use of wet grinding, blending and pelletising systems if other techniques for the control of dust are not possible or appropriate.
- Thermal cleaning and pyrolysis systems (e.g. swarf drying and decoating) that use robust afterburning equipment to destroy combustion products, e.g. VOCs and PCDD/F. The gases should be held at a temperature greater than 850 °C (1100 °C if they contain more than 1 % halogenated organic material), in the presence of at least 6 % oxygen for a minimum of two seconds. Lower residence times may also result in the complete destruction of VOCs and PCDD/F but this should be demonstrated at a local level. Gases should be cooled rapidly through the temperature window of PCDD/F reformation.
- Manual and mechanical separation techniques to pretreat waste streams, such as the removal of batteries, etc. out of electronic equipment according to the WEEE Directive or the separation of car catalysts from their steel casing.

- Reducing the potential for VOCs. Washing processes to remove oil or other contaminants should use benign solvents. Efficient solvent and vapour recovery systems should be used with these techniques.
- The use of steel belt, updraught or fully enclosed downdraught sintering processes. Steel belt sintering has several advantages for certain metal groups and can minimise gas volumes, reduce diffuse emissions and recover heat. Off-gas extraction systems should prevent diffuse emissions.
- The use of rotary kilns with wet ash quenching for processes involving the reduction in volume of material such as photographic film. Smaller installations may use a moving grate furnace. In both cases, the combustion gases should be cleaned to remove dust and acid gases if they are present.

Achieved environmental benefits

Prevention of metals, dust and other compounds emissions.

Environmental performance and operational data

No information provided.

Cross-media effects

Increase in energy use.

Technical considerations relevant to applicability

Generally applicable.

Economics

No information provided but the processes are known to be operating economically.

Driving force for implementation

- Reduction of emissions.
- Raw material savings.

Example plants

Plants in DE, AT, FR, BE, PL and NL.

Reference literature

[196, Finkeldei, L. 1999].

2.12.4.3 Techniques to prevent diffuse emissions and collect off-gases from metal production processes

Description

Set of techniques to prevent diffuse emissions from metal production processes.

Technical description

The techniques to consider are based on the application of the principles of techniques reported above in Section 2.4.2. These techniques rely on the professional design and maintenance of the collection systems, as well as on the on-line monitoring of emissions in the clean gas duct.

The techniques to consider are the following:

- Furnace sealing (or the use of sealed furnaces) combined with process control techniques is the technique that should be applied wherever possible to prevent or contain emissions from process plants. Annex 13.1, covering furnaces, indicates where furnace sealing is possible and where other collection techniques may be used to provide integral gas collection [246, France 2008]. Some examples include sealed smelting furnaces, sealed electric arc furnaces and the sealed point feed cell for primary aluminium production.

Furnace sealing still relies on sufficient gas extraction rates to prevent pressurisation of the furnace.

If sealed furnaces are not available, for example when retrofitting an existing open furnace, the maximum sealing possible to contain furnace gases can be used. An example of this is the use of a 'fourth hole' in the roof of an electric arc furnace to extract the process gases as efficiently as possible, see Figure 2.18.

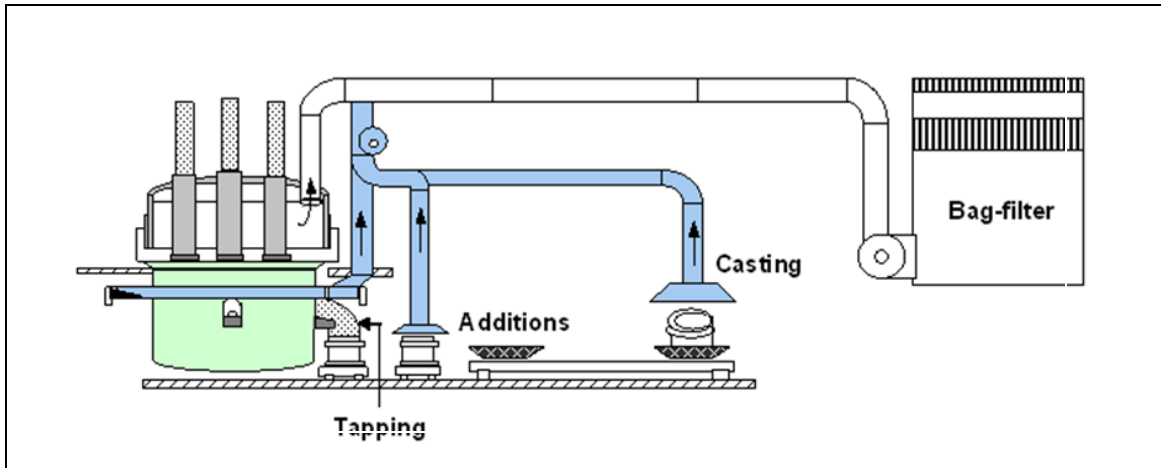

Figure 2.18: Fourth hole fume collection

- The use of sealed charging systems for the furnaces to prevent diffuse emissions during furnace opening, e.g. the use of charging skips that seal against a furnace feed door and the use of through-hood charging systems. These techniques may be applicable to all new and existing processes, particularly for non-continuous processes.
- Maintenance of the collector hood, the ducts, the filter system and the fan is vital to ensure that collection or extraction rates remain at the designed level. It is also important to use a system of dampers and alternative extraction points to direct suction to the points where fumes are being emitted. An example of this is when the furnace is tilted to tap off slag or metal and the fourth hole extraction point is not then connected to the ducting. Dampers should be used to direct suction to the tapping point. The automatic changeover of dampers is preferable.
- Regular inspection and preventative maintenance should be used to ensure that physical damage from collision or abrasion, deposition in ductwork and deposition on fan blades does not occur. This technique is applicable to all new and existing processes.
- An important established practice to achieve good extraction is the use of automatic controls for dampers so that it is possible to target the extraction effort to the source of the fumes without using too much energy. The controls enable the extraction point to be changed automatically during different stages of the process. For example, the charging and tapping of furnaces do not usually occur at the same time and so the charging and tapping points can be designed to be close together so that only one extraction point is needed. The extraction point is also designed to allow easy access to the furnace and give a good rate of extraction. The hooding is constructed robustly and is maintained adequately. This principle is easily applied to a short rotary furnace. An example of this is an adaptation of a short rotary furnace (see Figure 2.19). The feed door and tapholes are at the same end of the furnace. The fume collection hood allows full access for a slag ladle and feed conveyor. It is also robust enough to withstand minor impacts during use.

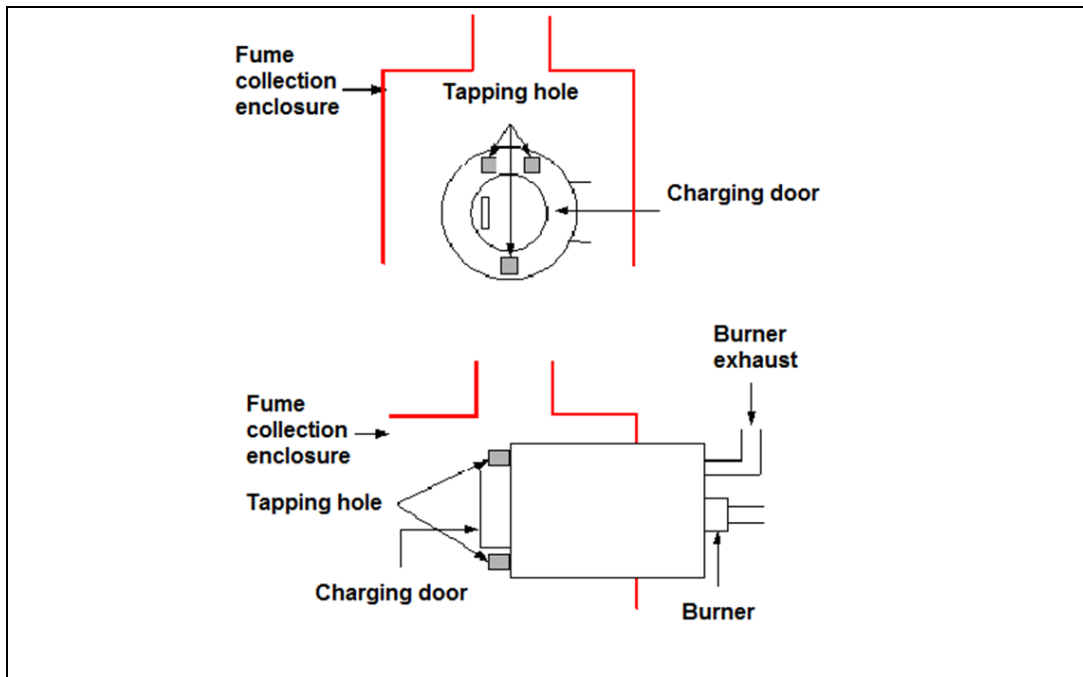

Figure 2.19: Coinciding charging and tapping system

The principle of targeting the extraction effort to a changing source of fumes can also be achieved though by automatically controlling dampers to extract the main source of fumes during the operating cycle, e.g. charging, tapping. The short rotary furnace and the top-blown rotary converter (TBRC) may also be totally enclosed.

- Use of computerised fluid dynamics (CDF) and tracers to model the flow of furnace gases. Improvements have been made to fume capture by applying CFD modelling to the furnace gases to assist in developing optimum fume collection. The deployment of a guided cover curtain to achieve maximum performance has resulted from this work to assess smoke patterns. Significant progress was also made by modifying the charging pattern to an electric reduction furnace by feeding small quantities of charge material on a regular basis rather than by full batch charging. The main effect was the reduction in the surge events that cause diffuse emissions, and the prevention of overcooling the furnace; the results on PCDD/F reduction in this case were significant. [233, COM 2008]
- Use of secondary hood gas collection. If diffuse emissions cannot be prevented or minimised to an acceptable level, secondary fume collection systems can be used. Some furnaces can be equipped with secondary hoods in order to collect diffuse emissions during charging or tapping. The fan suction is provided directly at the source of the fumes to optimise the reduction of diffuse emissions. It is possible to use an intelligent system to operate the fans automatically when process stages that produce fumes are operated. Alternatively, the air could be extracted at the roof ventilator, but a large volume of air would have to be handled which might not be cleaned effectively in a fabric filter. Other disadvantages are high energy consumption, high investment and more waste (used filter media). Secondary fume collection systems are designed for specific cases. Energy use can be minimised by automatically controlling the point of extraction using dampers and fan controls, so the systems are deployed when and where they are needed, for example during charging or during the roll-out of a converter.

Below are some examples of secondary hood gas collection.

- o In the process shown in Figure 2.20, the airflow rate is controlled via a closed-cycle control system by reducing dampers. Ventilator fans with speed controls are used in order to minimise the energy consumption; 875 000 Nm³/h of secondary

gases are captured and cleaned in fabric filters. And 13.6 GWh/yr of electrical energy is consumed and 700 kg of dust is collected per hour.

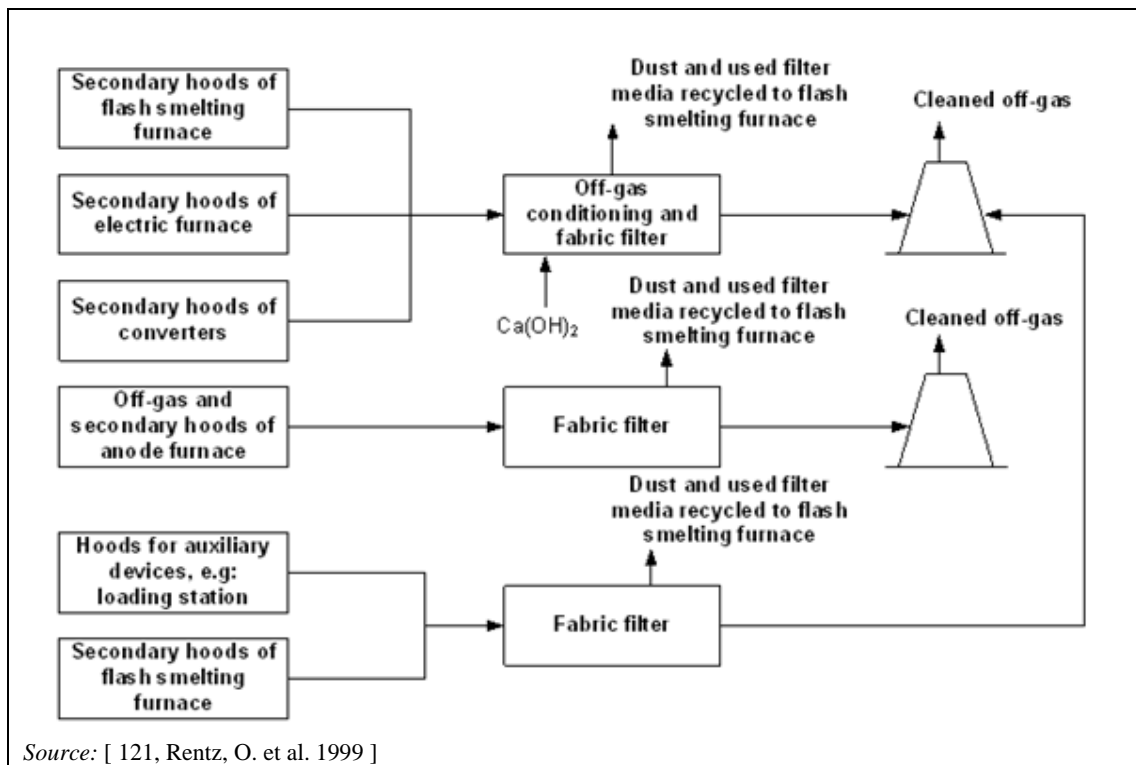
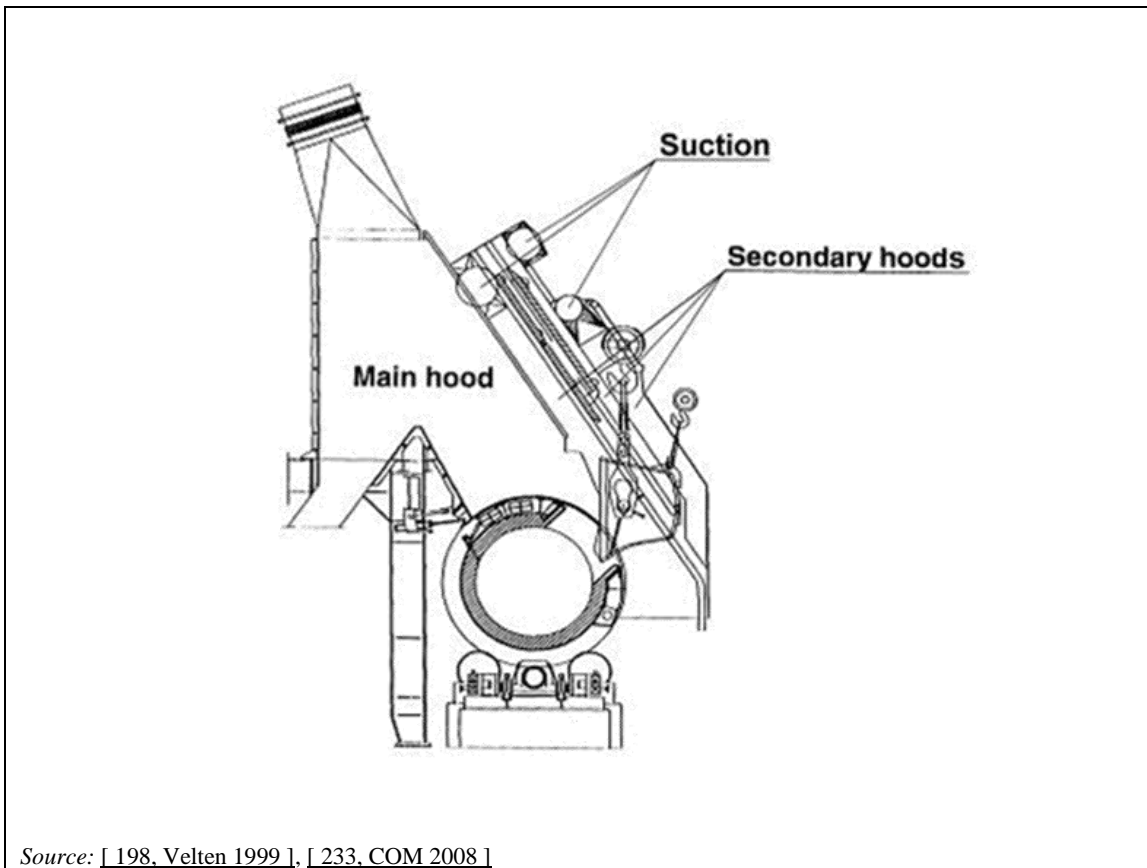

Figure 2.20: Outline of a secondary fume collection system for a primary copper process

- o The collection of gases from a batch converter can be difficult as ladle transfers interfere with the collection hoods. Some installations collect all of the fumes from the roof line, but at high energy costs. Another installation uses a system of up to three hoods, in addition to the main hood. These hoods can be connected either to the sulphuric acid plant (hood 1) or to the secondary cleaning system (hoods 2 and 3). During filling and pouring operations, the individual hoods are motor-driven to the positions that ensure optimal collection efficiency. The secondary hood gas collection system is shown in Figure 2.21.



Source: [198, Velten 1999], [233, COM 2008]

Figure 2.21: Secondary hooding system for a converter

- Another example shows how tapping fumes from a blast furnace can be collected by a secondary fume collection system. The dedusting equipment is composed of various hoods located above the taphole of a blast furnace, the main metal runner, and the device where the liquid metal is poured into the torpedo ladle. The collected fumes are cleaned in a separate fabric filter. The taphole fume collection system (viewed from the top of the blast furnace) is shown in Figure 2.22.

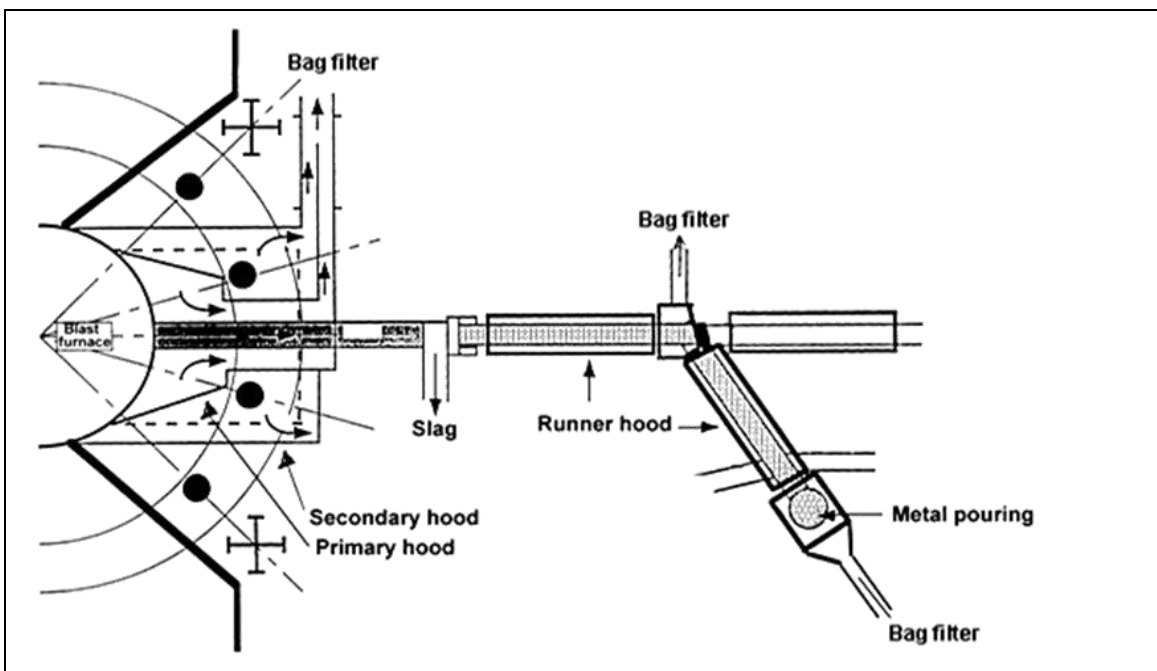

Figure 2.22: Taphole fume collection

- Use of tertiary collection systems. Gases that are not collected by the secondary hoods can be collected in a tertiary collection system that encloses the whole operating area such as the 'house-in-house' or 'doghouse' concept shown in Figure 2.2. An intelligent system is used to operate the fans automatically when process stages that produce fumes are operated. The 'house-in-house' concept uses this principle to prevent excessive energy consumption.

Achieved environmental benefits

- Efficient capture of diffuse emissions of metals, dust, sulphur dioxide and other compounds.
- Most dusts are returned to the processing stages or are sold to recover valuable metals.

Environmental performance and operational data

This is included where available in the examples given above.

Cross-media effects

Increase in energy use.

Technical considerations relevant to applicability

These techniques are generally applicable.

A tertiary fume collection system such as 'house-in-house' is applicable to tapping and charging operations for new installations or major upgrades of existing installations due to the dimension of furnaces and space requirements.

Economics

No information provided but the examples are known to be operating economically.

Driving force for implementation

Capture of diffuse emissions.

Example plants

Plants in DE, AT, FR, BE and PL.

Reference literature

[121, Rentz, O. et al.1999], [160, Steudtner 1998], [196, Finkeldei, L. 1999],
[233, COM 2008], [274, COM 2008].

2.12.5 Channelled emissions to air

Since these techniques are widely applied within the sector, general information about these techniques (such as 'Description' and 'Technical description') can be found in this section. Metal-specific information (such as 'Environmental performance and operational data' and 'Example plants') can be found in the metal-specific chapters.

2.12.5.1 Techniques to reduce dust, metal and particle emissions

The following techniques are used for the removal of particles such as dust, metals and fumes.

2.12.5.1.1 Electrostatic precipitators

Description

Electrostatic precipitators operate such that particles are charged and separated under the influence of an electrical field. They are capable of operating under a wide range of conditions.

Electrostatic precipitators specially designed to operate with high-temperature off-gases (> 300 °C) are known as hot electrostatic precipitators.

Technical description

The electrostatic precipitator (ESP) is used extensively in the industry and is capable of operating under a wide range of temperature, pressure and dust burden conditions. It is not particularly sensitive to particle size and collects dust in both wet and dry conditions. Corrosion and abrasion resistance is built into the design.

The ESP consists of a series of high-voltage discharge electrodes and corresponding collector electrodes. Particles are charged and subsequently separated from the gas stream under the influence of the electrical field generated between the electrodes. The electrical field is applied across the electrodes by a small direct current at a high voltage (100 kV). In practice, an ESP is divided into a number of discrete zones (up to five zones are commonly used). The ESP is shown in Figure 2.23.

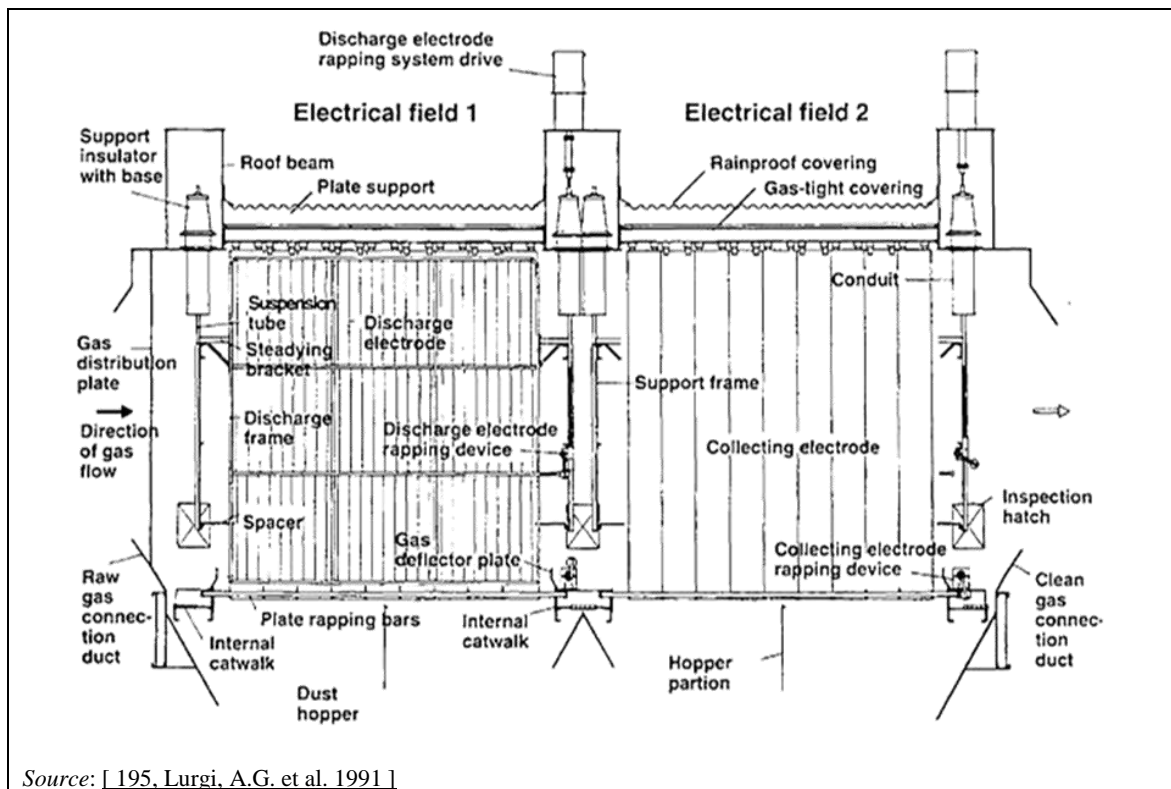

Source: [195, Lurgi, A.G. et al. 1991]

Figure 2.23: Typical arrangement of an electrostatic precipitator (only two zones shown)

Particles are removed from the gas stream in four stages:

- application of an electrical charge to the dust;
- placement of the charged dust in an electrical field;
- capture of the dust on the collecting electrode;
- removal of the dust from the surface of the electrode.

The discharge electrodes must be rapped or vibrated to prevent dust build-up, and their mechanical strength must be compatible with the transmission of the rapping blow or vibration. The mechanical reliability of the discharge electrodes and their supporting frame is important, as even a single broken wire can short out an entire electrical field of the precipitator.

The performance of an ESP follows the Deutsch formula, which relates efficiency to the total surface area of the collector electrodes, the volumetric flow rate of the gases and the migration velocity of the particles. Therefore, for a given dust, maximising the surface area of the collector electrodes is very important, and so current practice is to use wide electrode spacing. This practice relies, in turn, on good rectifier design and control.

The industry uses rectifier designs which include the use of separate rectifier sections for each zone or portion of a zone of the ESP. This allows the applied voltage to be varied in the inlet and outlet zones to take account of the reduced dust load towards the outlet, and gives the ability to operate the zones at progressively higher voltages without sparking. Good design is also practised by using automatic control systems, which maintain the optimum high tension (HT) voltage applied to the electrodes in a particular zone without sparking. An automatic monitor is used to apply the maximum voltage without sparking and constantly varies the HT. Fixed HT power supplies are unlikely to provide optimal collection efficiencies.

The resistivity (the inverse of the conductivity) of the dust is particularly important. If it is too low, the particles reaching the collector electrode lose their charge easily and dust re-entrainment can occur. When the dust has a high resistivity, an insulating layer is formed on the electrode, which hinders normal corona discharge and leads to a reduction in the collection

efficiency. Most dusts have a resistivity within the operating range, though collection can be improved by conditioning the dust. Ammonia and sulphur trioxide are commonly used. The resistivity can also be reduced by lowering the gas temperature or by adding moisture to the gas.

An ESP usually does not achieve final dust concentrations as low as those achieved by a fabric filter. To achieve the best performance from a precipitator, the gas flows through the units are optimised to give a uniform flow to prevent gas from bypassing the electrical field. Correct design of inlet ducting and the use of flow distribution devices within the inlet mouthpiece are used to achieve a uniform flow at the inlet to the precipitator.

Achieved environmental benefits

Reduction of dust and metals emissions.

Environmental performance and operational data

Performance data are given in the metal-specific chapters.

Cross-media effects

- Increase in energy use.
- Waste may be produced if the collected dust cannot be returned to the process.

Technical considerations relevant to applicability

Information can be found in the metal-specific chapters.

Economics

The processes are operating economically and costs, where they are available, are reported in Annex 13.3 of this document and in the metal-specific chapters.

Driving force for implementation

- Reduction of dust emissions.
- Raw material savings if dust can be returned to the process.

Example plants

Information can be found in the metal-specific chapters.

Reference literature

[196, Finkeldei, L. 1999], [73, Theodore, L. et al. 1992], [77, Soud, H.N. 1995], [189, VDI 1998], [195, Lurgi, A.G. et al. 1991].

2.12.5.1.2 Wet electrostatic precipitator

Description

The technique consists of an electrostatic precipitator in which the collected material is removed from the plates of the collectors by flushing with a suitable liquid, usually water. A mechanism is usually installed to remove water droplets before discharge of the waste gas (e.g. a demister or a last dry field).

Technical description

Wet electrostatic precipitators operate on the same principles. In this case, the collected dust is removed from the collector plates or tubes by the liquid film formed by the condensing water and precipitated collected acid mist. In the case of a high solids content, built-in atomising nozzles can be used to spray water continuously into the precipitator to prevent the formation of sludge deposits on the collecting electrodes. The spray increases the liquid film on the collecting electrodes and reduces its solids content. In addition, wet precipitators are equipped with flushing systems. Flushing is carried out intermittently. The high-voltage supply is interrupted during the flushing process. They offer advantages for certain dusts that adhere to conventional plates or when other components in the gas stream interfere with the operation, for example in

the case of a cool, damp gas. A liquid effluent is produced that requires further treatment. A wet ESP is shown in Figure 2.24.

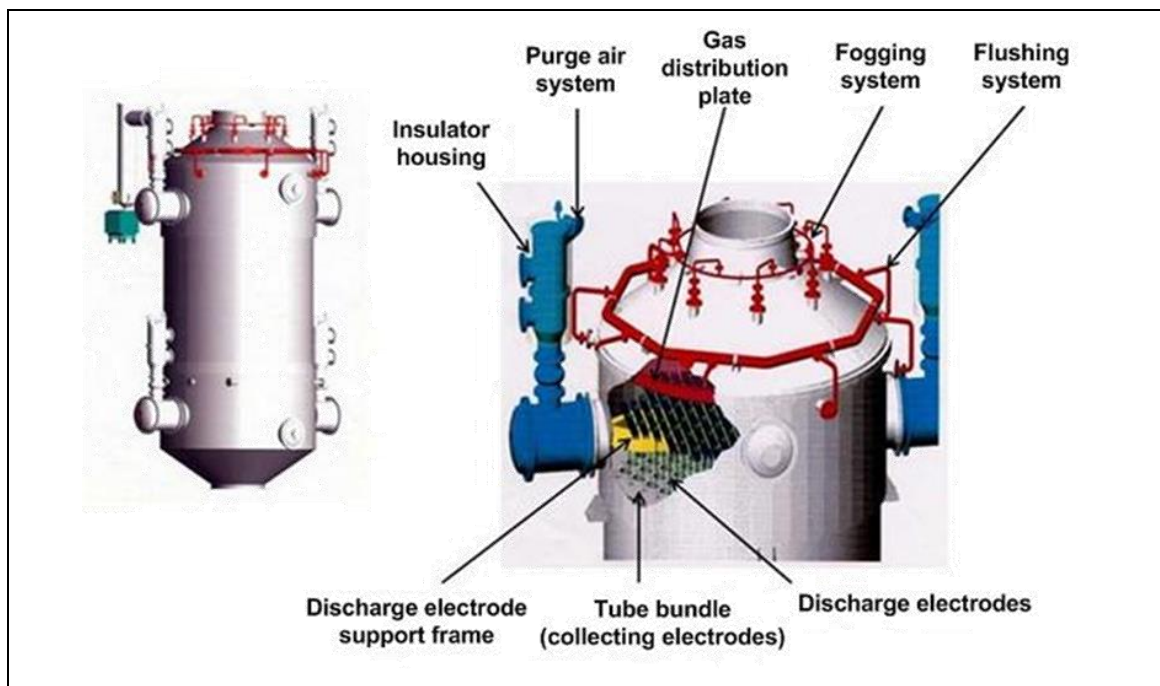

Figure 2.24: Wet electrostatic precipitator

Wet ESPs or moving electrode ESPs can be used for difficult dusts or moist gases.

Achieved environmental benefits

Reduction of dust, metals and other compounds emissions.

Environmental performance and operational data

Performance data are given in the metal-specific chapters.

Cross-media effects

- Increase in energy use.
- Waste water is produced that should be treated to prevent the discharge of metals and other substances to water.

Technical considerations relevant to applicability

Information can be found in the metal-specific chapters.

Economics

The processes are known to be operating economically and costs, where they are available, are reported in Annex 13.3 of this document and in the metal-specific chapters.

Driving force for implementation

- Reduction of dust and other compounds emissions.
- Raw material savings if dust can be returned to the process.

Example plants

Information can be found in the metal-specific chapters.

Reference literature

[195, Lurgi, A.G. et al. 1991], [196, Finkeldei, L. 1999], [73, Theodore, L. et al. 1992], [77, Soud, H.N. 1995], [189, VDI 1998].

2.12.5.1.3 Cyclones

Description

Cyclones use inertia to remove particles from the waste gas stream, imparting centrifugal forces, usually within a conical chamber.

Technical description

Cyclones were installed in many of the processes in the 1980s and are still in widespread use today (2014). The cyclone is an inertial gas-cleaning device. Dust becomes separated from the gas stream when the direction of the gas flow is changed and the dust continues in the original direction by virtue of its inertia and is deposited onto a collection surface. The cyclone is shown in Figure 2.25

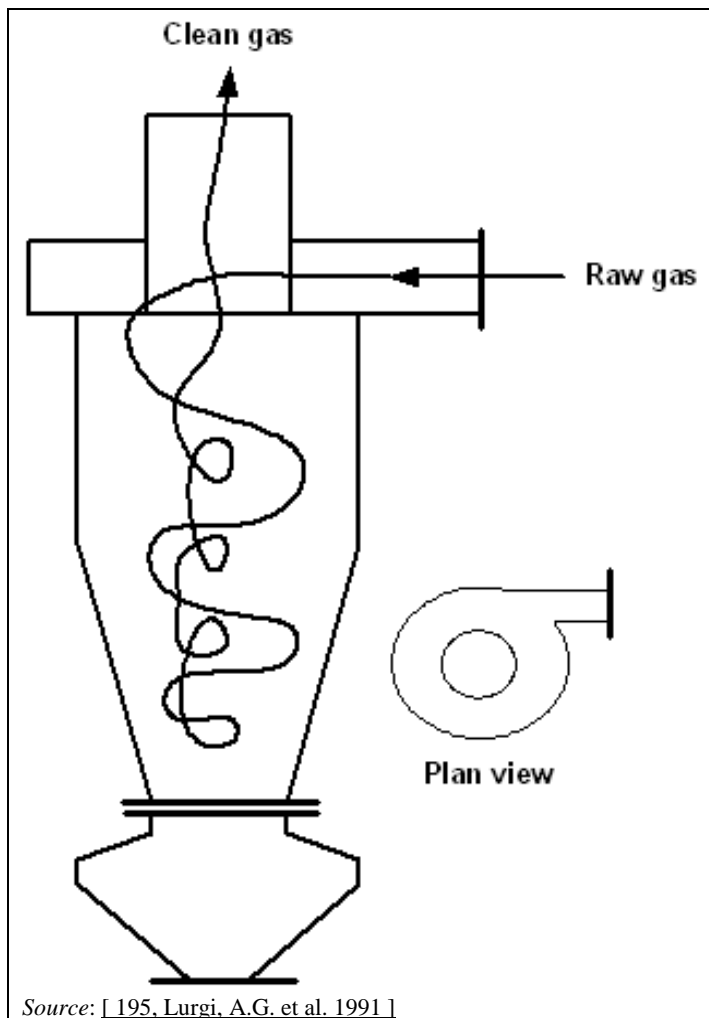

Figure 2.25: Arrangement of a cyclone

The inlet gas is channelled into a spiral flow. Centripetal forces operating within the spiral provide the change of direction, and the particles above a critical mass will be deposited onto the cyclone walls.

Cyclones are not used as a stand-alone technique in this industrial sector.

Achieved environmental benefits

Reduction of dust and metals emissions.

Environmental performance and operational data

Performance data are given in the metal-specific chapters.

Cross-media effects

- Increase in energy use.
- Waste may be produced if the collected dust cannot be returned to the process.

Technical considerations relevant to applicability

Information can be found in the metal-specific chapters.

Economics

The processes are known to be operating economically and costs, where they are available, are reported in Annex 13.3 of this document and in the metal-specific chapters.

Driving force for implementation

- Reduction of dust emissions.
- Raw material savings if dust can be returned to the process.

Example plants

Information can be found in the metal-specific chapters.

Reference literature

[73, Theodore, L. et al. 1992], [77, Soud, H.N. 1995], [195, Lurgi, A.G. et al. 1991], [196, Finkeldei, L. 1999],

2.12.5.1.4 Fabric or bag filters**Description**

Bag filters are constructed from porous woven or felted fabric through which gases flow and particles are removed by use of a sieve or another mechanism. Use of a bag filter requires a fabric material selection suited to the characteristics of the waste gases and the maximum operating temperature. Cartridge filters are a variation of bag filter which uses cartridges instead of bags.

Technical description

Bag filter systems are used for many applications within this industry sector, due to their high efficiency in controlling the fine dust encountered in melting and smelting operations. Settling and cooling chambers, but also waste heat boilers, can be used before bag filters to reduce the likelihood of fires, to condition the particles, and to recover the heat content of the off-gas before dedusting.

Bag filters with various cleaning systems are shown in Figure 2.26, Figure 2.27 and Figure 2.28.

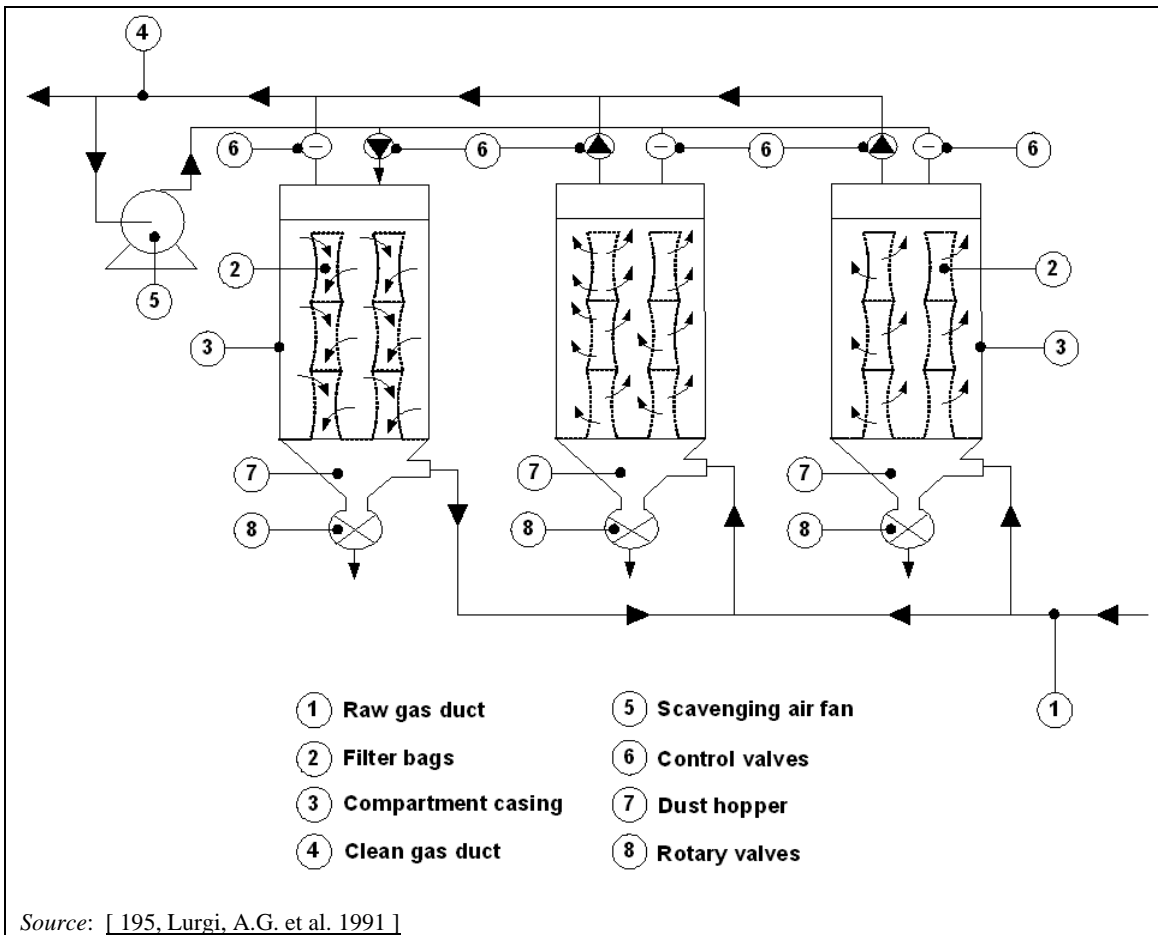

Figure 2.26: Reverse airflow bag filter (with one compartment in the cleaning cycle)

The basic principle of fabric filtration is to use a fabric membrane which is permeable to gas but which will retain the dust. The bags are usually supported on a metal frame and each bag will incorporate a method of sealing into the baghouse structure. Initially, dust is deposited both on the surface fibres and within the depth of the fabric, but as the surface layer builds up, it itself becomes the dominating filter medium. As the dust cake thickens, the resistance to gas flow is increased. Periodic cleaning of the filter media is therefore necessary to control the gas pressure drop across the filter. The direction of the gas flow to be treated can be either from the inside of the bag to the outside or from the outside of the bag to the inside.

Bag filters are normally classified according to the method by which the filter media are cleaned. Regular dust removal from the fabric is important in order to maintain effective extraction efficiency, but it also influences the operating life of the bag.

The most common cleaning methods include reverse airflow, mechanical shaking, vibration, low-pressure air pulsing and compressed air pulsing. Acoustic horns are also used for the cleaning of bags. The normal cleaning mechanisms do not result in the bag returning to pristine condition, as the particles deposited within the depth of the cloth reduce the pore size between the fibres, though this enables high efficiencies to be achieved for cleaning submicron fumes.

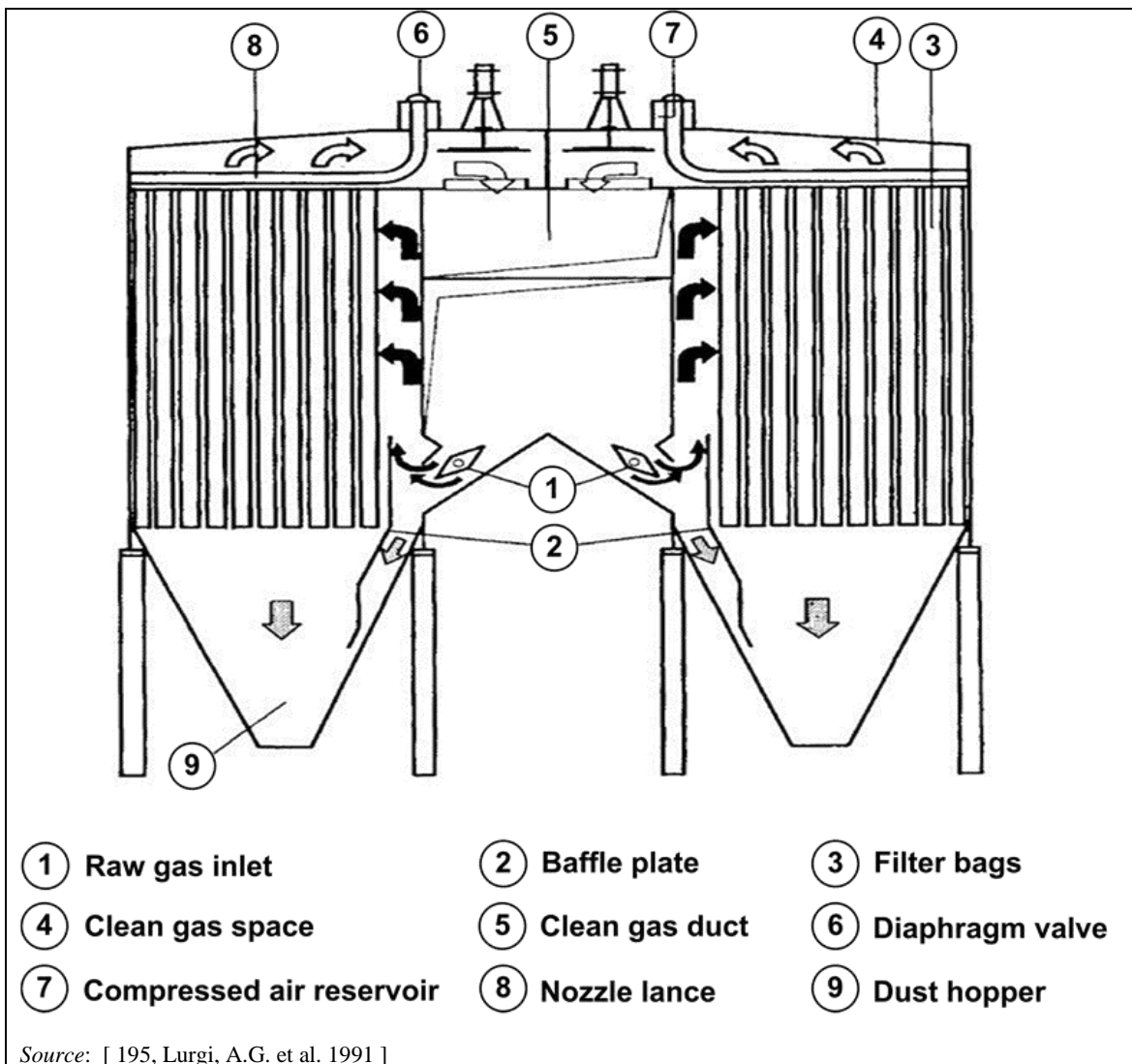

Figure 2.27: Reverse pulse jet cleaning system

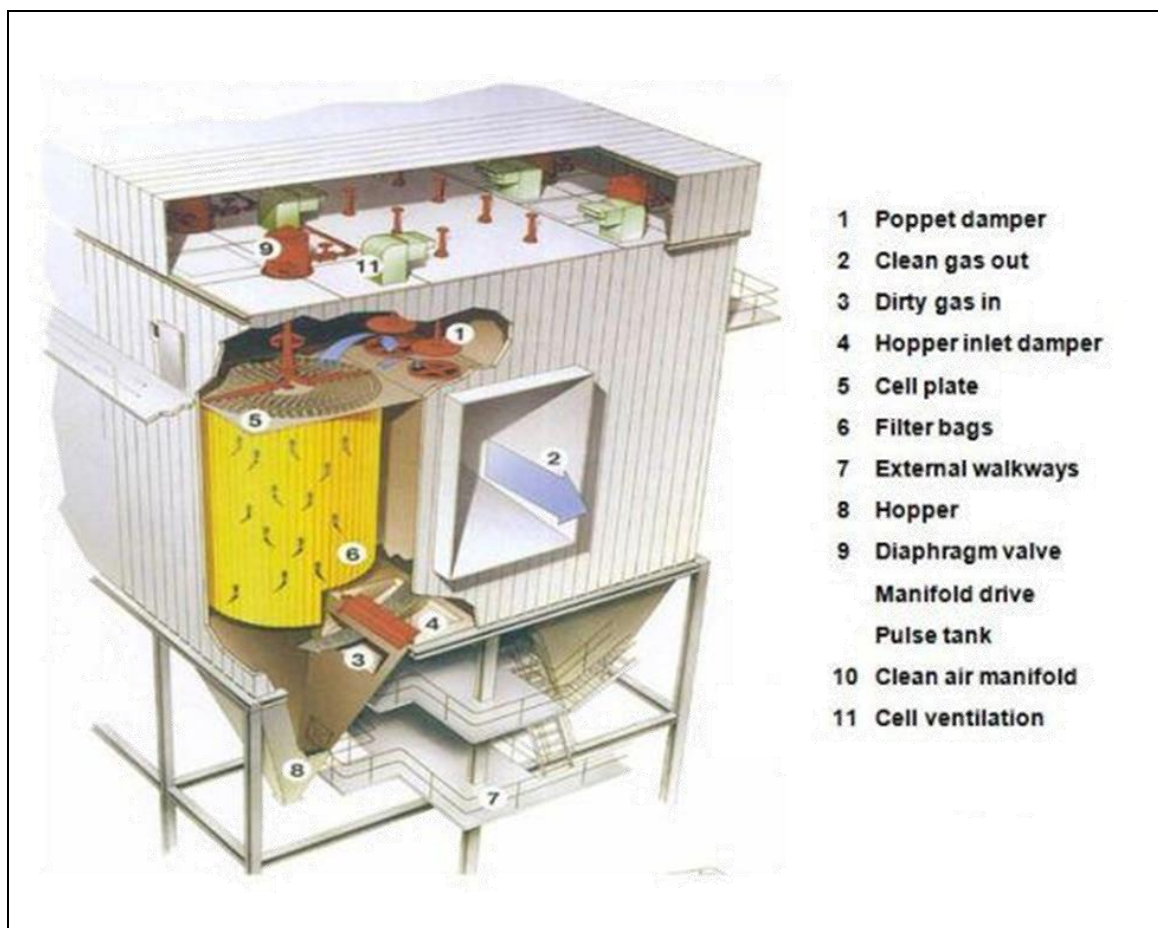

Figure 2.28: Low-pressure air pulsing cleaning system

Bag filters are designed on the basis of anticipated filtration velocity, which is defined as the maximum acceptable gas velocity flowing through a unit area of fabric ($\text{m}^3/\text{s} \div \text{m}^2$ expressed in m/s). Filtration velocities generally lie in the range of 0.01 m/s to 0.04 m/s depending on the application, the filter type and the cloth.

Fabric selection takes into account the composition of the gases, the nature and particle size of the dust, the method of cleaning to be employed, the required efficiency and economics. The gas temperature is also considered, together with the method of gas cooling, if any, and the resultant water vapour and acid dew point.

Characteristics of the fabric considered include chemical resistance, fibre form and type of yarn, fabric weave, fabric finish, abrasion and flex resistance, strength, collection efficiency, cloth finishes and cloth permeability.

Wear of the filter bags results in a gradual reduction in performance, which can be measured. Damage or catastrophic failure of several bags is a danger when corrosion occurs, abrasive material is filtered, or when there is a risk of fire. Simple on-line monitoring systems such as pressure drop indicators or dust tell-tale devices give only a rough indication of performance.

Triboelectric or optical devices are used to measure the trend in the dust emitted from the bag filter to identify possible failure, and they can also be used to detect dust peaks during a cleaning cycle. When these measurements are integrated with a zoned cleaning system, the zone that contains damaged bags can be identified and local repairs can be made [123, Robson, T.G. et al. 1998]. Temperature measurement and alarms are also used.

Bag filters in some ferro-alloy processes use pressure filters with fans on the dirty fume/gas side. Developments have led to a closed suction filter with fans on the clean gas side. This technique is used in most of the other metal sectors and combines the advantages of gentle bag cleaning, which means a longer bag life, low operating and maintenance costs, and, due to the closed filter, a defined gas volume.

For correct operation, one or more of the following features should be applied.

- Particular attention to the choice of filter material and the reliability of the mounting and sealing system. Good maintenance should be practised. Modern filter materials are generally more robust and have a longer life. The extra cost of modern materials is more than compensated for by the extra life in most cases.
- An operating temperature above the dew point of the gas. Temperature-resistant bags and mountings are used at higher operating temperatures.
- Continuous dust monitoring using dust impingement, optical or triboelectric devices can be used to detect a filter bag failure. The device should interact if possible with the filter cleaning system so that individual sections, which contain worn or damaged bags, can be identified.
- The use of gas cooling and spark arresting where necessary. Cyclones are considered to be suitable methods for spark arresting. Most modern filters are arranged in multiple compartments, so damaged compartments can be isolated if required.
- Temperature and spark monitoring can be used to detect fires. Inert gas systems can be provided or inert materials (e.g. lime) may be added to the off-gas where there is a danger of ignition. Excessive overheating beyond the design limits of the fabric may produce toxic gaseous emissions.
- Pressure drop can be monitored to control the cleaning mechanism.

A number of different bag filter designs using different kinds of filter materials exist. The use of membrane filtration techniques (surface filtration) results additionally in an increased bag life, a higher temperature limit (up to 260 °C) and relatively low maintenance costs. Membrane filter bags consist of an ultrafine expanded polytetrafluoroethylene (PTFE) membrane laminated to a backing material. The particles in the off-gas stream are captured on the bag surface. Rather than forming a cake on the inside or penetrating the bag fabric, particles are repelled from the membrane, thus forming a smaller cake. This technique is applicable for all new and existing plants and may also be used for the rehabilitation of existing bag filters [141, Elkem Asa 1998].

Synthetic filter cloths, such as Teflon/fibreglass, have enabled bag filters to be used in a wide range of applications and to have an extended life. The performance of modern filter materials at high temperatures or in abrasive conditions is good, and cloth manufacturers can even help to specify the material for particular applications. With the correct design and suitable type of dust, very low dust emissions may be achieved in special cases. Greater reliability and a longer life repays the expense of modern bags. Achieving these levels is important as the dusts can contain significant levels of metals. To prevent leakage of unpurified gases to the atmosphere, the effect of warping of the distribution manifolds and a correct sealing of the bags should be taken into account, in line with good practice.

Due to their tendency to bind in certain circumstances (i.e. with sticky dusts or in airstreams close to the dew point) and their sensitivity to fire, they are not suitable for all applications. They may also be applicable to existing bag filters and can be retrofitted. In particular, the bag sealing system can be improved during annual maintenance periods, and filter bags can be changed for more modern fabrics during normal replacement schedules, which can also reduce future costs.

Achieved environmental benefits

Reduction of dust and metals emissions.

Environmental performance and operational data

Performance data are given in the metal-specific chapters.

A comparison of the most commonly used parameters of different filter systems is shown in Table 2.12.

Table 2.12: Comparison between different fabric filter systems

Parameter	Pulse jet filter	Membrane fibreglass filter	Fibreglass filter
Air to cloth ratio	80 to 90 m/h	70 to 90 m/h	30 to 35 m/h
Temperature limits	250 °C	280 °C	280 °C
Bag type	Polyester	Membrane/fibreglass	Fibreglass
Bag size	0.126 × 6.0 m	0.292 × 10 m	0.292 × 10 m
Cloth area per bag	2.0 m ²	9.0 m ²	9.0 m ²
Cage	Yes	No	No
Pressure drop	2.0 kPa	2.0 kPa	2.5 kPa
Bag life	Up to 30 months	6 to 10 years	6 to 10 years
<i>Source: [141, Elkem Asa 1998]</i>			

Cross-media effects

- Increase in energy use.
- Waste may be produced if the collected dust cannot be returned to the process.

Technical considerations relevant to applicability

Information can be found in the metal-specific chapters.

Economics

The processes are known to be operating economically and costs, where they are available, are reported in Annex 13.3 of this document and in the metal-specific chapters.

Driving force for implementation

- Reduction of dust emissions.
- Raw material savings if dust can be returned to the process.

Example plants

Information can be found in the metal-specific chapters.

Reference literature

[195, Lurgi, A.G. et al. 1991], [196, Finkeldei, L. 1999], [73, Theodore, L. et al. 1992], [77, Soud, H.N. 1995], [141, Elkem Asa 1998], [215, VDI 1997], [217, VDI 2004], [103, COM 1998].

2.12.5.1.5 Ceramic and metal mesh filters

Description

Low-density ceramic filters operate in a similar manner to fabric filters as far as operating principles, general arrangement and cleaning operations are concerned. Instead of cloth bags and their metal supports, rigid elements that resemble candle filters are used.

Technical description

There are several examples of these filters being used in this industry and very high dust removal efficiencies are achieved. Fine particles including PM₁₀ are removed.

They have a high degree of thermal resistance and it is often the limitations of the housings that determine the upper operating temperature. Expansion of the support system as the temperature rises is also a major factor as the sealing of the filter elements in the housing can be affected, resulting in leaks from the dirty gas stream into the clean gas stream. On-line failure detection

systems are used in the same way as fabric filters. Ceramic and mesh filters are not flexible like a fabric filter. When cleaning them with an air pulse, the fine dust will not be removed as effectively as with a cloth filter, resulting in a build-up of fines within the filter and thus reducing the capacity of the filter. This effect is more likely to happen with very fine dust.

Ceramic filters are made from aluminosilicates and can be precoated with a variety of materials to improve chemical or acid resistance or remove other pollutants. The filter elements are relatively easy to handle when new but become brittle after exposure to heat and there is therefore a risk that they may break during maintenance or rough attempts to clean them.

The presence of sticky dust or tar is a potential problem as this may not be cleaned from the element during the normal cleaning cycle and this could cause a significant increase in the pressure drop. The effect of temperature on the material to be collected is therefore an important factor in the design of a plant. With the correct design and suitable dust, very low dust emissions are achieved. Achieving low dust emissions is important as the dusts contain significant levels of metals.

Similar performances at high temperatures have also been reported using a redesigned metal mesh filter. The development allows the rapid establishment of a dust cake layer after cleaning while the zone is off-line.

Filters that are correctly designed, constructed and sized for the application incorporate the following features.

- The housing, mounting and sealing systems are appropriate for the chosen use, are reliable and temperature-resistant.
- Continuous dust monitoring using dust impingement, optical or triboelectric devices to detect filter failure. The device should interact with the filter cleaning system if possible so that individual sections that contain worn or damaged elements can be identified.
- Gas conditioning, where necessary.
- The use of pressure drop to monitor and control the cleaning mechanism.

Due to their tendency to blind in certain circumstances (i.e. with sticky dusts or in airstreams close to the dew point) they are not suitable for all applications. They may also be applicable to existing ceramic filters and can be retrofitted. In particular, the sealing system can often be improved during normal maintenance periods.

Achieved environmental benefits

Reduction of dust and metals emissions.

Environmental performance and operational data

Performance data are given in the metal-specific chapters.

Cross-media effects

- Increase in energy use.
- Waste may be produced if the collected dust cannot be returned to the process.

Technical considerations relevant to applicability

Information can be found in the metal-specific chapters.

Economics

The processes are known to be operating economically and costs, where they are available, are reported in Annex 13.3 of this document and in the metal-specific chapters.

Driving force for implementation

- Reduction of dust emissions.
- Raw material savings if dust can be returned to the process.

Example plants

Information can be found in the metal-specific chapters.

Reference literature

[195, Lurgi, A.G. et al. 1991], [196, Finkeldei, L. 1999], [73, Theodore, L. et al. 1992], [77, Soud, H.N. 1995], [226, Nordic Report 2008], [103, COM 1998].

2.12.5.1.6 Wet dust scrubber

Description

Wet dust scrubbing is a variation of wet gas scrubbing (see Section 2.12.5.2.2), which can additionally recover/abate dust. Wet dust scrubbing entails separating the dust by intensively mixing the incoming gas with water, mostly combined with the removal of the coarse particles through the use of centrifugal force. In order to achieve this, the gas is released inside tangentially. The removed solid dust is collected at the bottom of the dust scrubber. Aside from the dust, inorganic chemicals such as SO_2 , NH_3 , NH_4Cl , VOCs and metals that may be attached to the dust are removed.

Technical description

Particulate collection by wet scrubbing occurs by three main mechanisms: inertial impacting, interception and diffusion. The particle size to be collected is an important factor and the wettability of the material to be collected can also be significant.

A radial flow wet scrubber is shown in Figure 2.29.

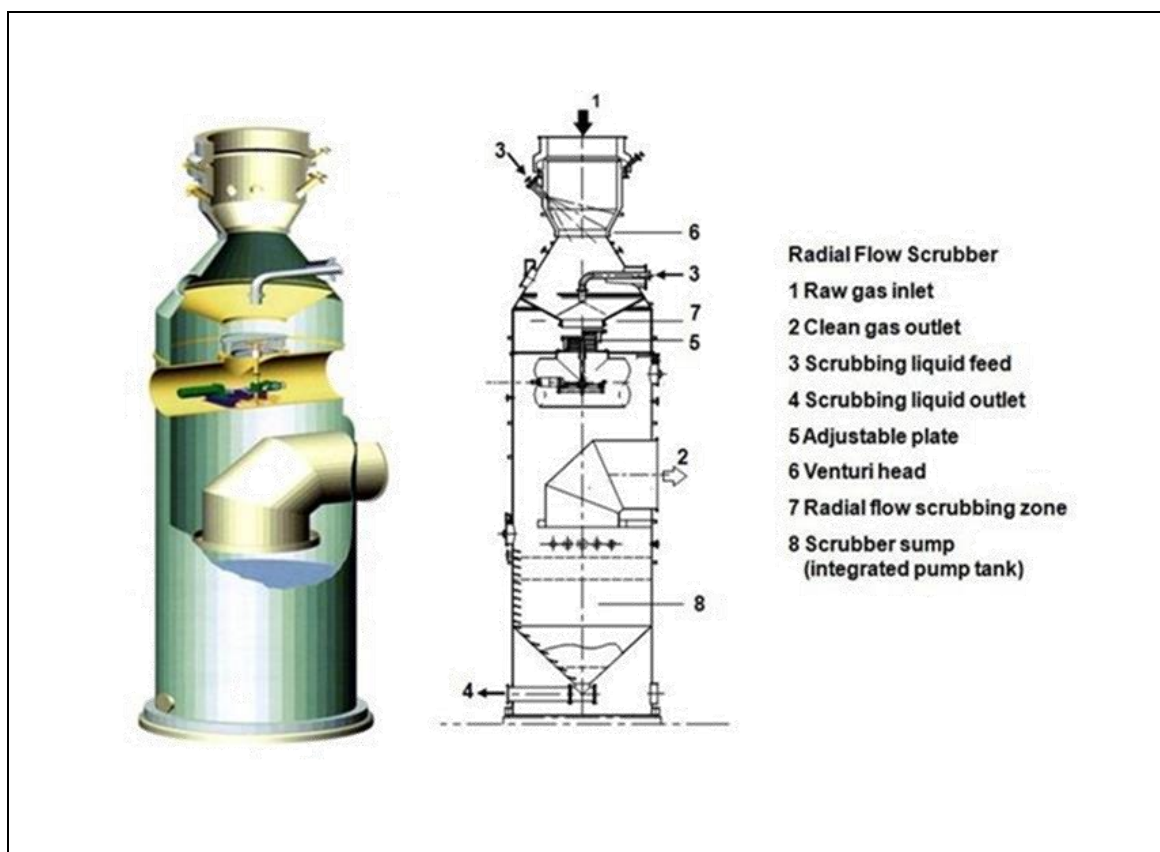

Figure 2.29: Radial flow wet scrubber

Wet scrubbers are used for cooling, saturating and precleaning gases, e.g. when arranged upstream of wet electrostatic precipitators. Typical examples are the Venturi scrubber or the radial flow scrubber with an adjustable pressure drop. Wet scrubbers are used in many different

non-ferrous metal production processes, for instance copper, zinc and lead and also in the production of ferro-manganese alloys in closed furnaces. Scrubber design is based on the relationship of gas and liquid velocity and of gas volume and liquid quantity. These parameters determine the pressure drop across the scrubber and thus the collection efficiency.

Cascade or Venturi wet scrubbers are often used for the dedusting of CO-rich off-gases from sealed electric arc furnaces. The gas is then used as high calorific value gas and is emitted after further treatment. It is also used to treat gases from a steel belt sintering machine, where the dust is very abrasive but easily wetted. Without this scrubber action, the fabric filter life would be severely restricted and rapid fabric wear would result in poor performance.

Scrubbers are used when the nature of the dust or the gas temperature precludes the use of other techniques or when the dust is particularly suitable for removal in a scrubber. Their use can also be considered when gases need to be removed simultaneously with dust or when they form part of a chain of abatement techniques, for example in dedusting prior to a sulphuric acid plant. Sufficient energy should be applied to ensure the wetting and interception of the particles.

Wet scrubbers should incorporate a monitoring system for pressure drop, scrubbing liquid flow and (if acid gases are being abated) pH. The scrubbed gases should exit the scrubber to a mist eliminator.

Experience shows that the efficiency of wet scrubbers is strongly dependent upon the particle size and their total energy usage, particularly upon the pressure drop across the collection zone. Moreover, provided the liquid is evenly dispersed within the scrubber, similar pressure drops will often give similar efficiencies on the same dust for quite different scrubber designs. Thus, it is not possible to design a wet scrubber that has high efficiencies without a high energy consumption, unless the dust concerned is particularly easy to wet. A variety of designs for high-energy scrubbers exist based on radial flow, jet, Venturi and cascade principles. Scrubbers have an application for dusts that are difficult to remove with other techniques. In general, the gases are then used in another process (e.g. as a fuel gas) and are not emitted. They are also used in conjunction with wet ESPs to cool and clean gases before conversion in sulphuric acid plants or to absorb acid gases.

Achieved environmental benefits

Reduction of dust, metals and other compounds emissions.

Environmental performance and operational data

Performance data are given in the metal-specific chapters.

Cross-media effects

- Increase in energy use.
- Waste may be produced if the collected material cannot be returned to the process.
- Waste water is produced that needs additional treatment to prevent the discharge of metals to water.

Technical considerations relevant to applicability

Information can be found in the metal-specific chapters.

Economics

The processes are known to be operating economically and costs, where they are available, are reported in Annex 13.3 of this document and in the metal-specific chapters.

Driving force for implementation

- Reduction of dust emissions.
- Raw material savings if dust can be returned to the process.

Example plants

Information can be found in the metal-specific chapters.

Reference literature

[196, Finkeldei, L. 1999] [195, Lurgi, A.G. et al. 1991], [216, VDI 1998] [226, Nordic Report 2008], [103, COM 1998].

2.12.5.1.7 Overview of dust abatement techniques

An overview of dust abatement techniques is given in Table 2.13 below.

Table 2.13: Overview of dust abatement techniques

Description	Cross-media effects	Operational data (potential problems)	Applicability	Driving force for implementation
Fabric filters	None if dust is reused	Clogging, fires, sealing. Maximum operating temperature 250 °C	Most with good sealing and modern fabrics	Good performance for suitable dusts. Potential to recycle dust to process
Wet electrostatic precipitator	Source of effluent	Wire breakage and shorting. Maximum operating temperature 80 °C	Improved performance for wet gases	Good performance for suitable dusts, low pressure drop but effluent produced
Electrostatic precipitator	None if dust is reused	Variation in particles, wire breakage and shorting. Maximum operating temperature 450 °C	Most with good control systems and gas distribution	Low pressure drop, reliable, low maintenance
Wet dust scrubber	Source of effluent	Lower performance and blockages. Maximum operating temperature 1000 °C inlet	Cleaning or precleaning of gases prior to other methods. Only some dusts are suitable. Cleaning fuel gases for combustion or gases for acid plant	Removal of acid gases and mists
Ceramic filters	None if dust is reused	Fragility, clogging and sealing. Dust must be suitable. Maximum operating temperature 900 °C	Higher temperature operation	Very good performance for suitable dusts. Potential to recycle dust to process
Cyclones	None if dust is reused	Poor performance. Limited efficiency for fine particles. Maximum operating temperature 1100 °C	Pre-abatement	Precleaning of gases prior to other methods

2.12.5.2 Techniques to reduce gaseous compounds emissions

Gases such as NH_3 , SO_2 , SO_3 , HF, HCl and NO_x are produced in several processes, for example sulphur dioxide is produced during smelting and hydrogen fluoride is produced during electrolysis. Prevention and reduction techniques are available for these gases [213, VDI 1998]. Reduction of the emissions of these gases is often possible by process control or by fixing the material in a slag or matte. The use of low- NO_x burners and staged combustion air for furnaces and other combustion plants can prevent the formation of these gases.

Organic and metallic components can also be emitted from some processes and can be adsorbed using similar techniques.

The following techniques are used to remove gaseous components. More information is given in the metal-specific chapters (Chapters 3 to 10).

2.12.5.2.1 Afterburners/Afterburning chambers

Description

An afterburner or thermal oxidiser (TO) is a combustion system in which the pollutant within the exhaust gas stream reacts with oxygen in a controlled environment to create an oxidation reaction.

A regenerative afterburner or regenerative thermal oxidiser (RTO) is a combustion system that employs a regenerative process to utilise the thermal energy in the gas and carbon compounds using refractory support beds. A manifold system is needed to change the direction of the gas flow to clean the bed.

A catalytic afterburner or catalytic thermal oxidiser (CTO) is a combustion system where the decomposition is carried out on a metal catalyst surface at lower temperatures, typically from 350 °C to 400 °C.

Technical description

Combustion systems are used in the industry to oxidise CO, dust or gaseous carbonaceous material in a gas stream. Several types of combustion systems are used.

- High-temperature afterburners, also called thermal oxidisers, where the gases are typically heated to between 850 °C and 1000 °C and held for a minimum of 0.5 seconds (provided there are no chlorinated components) leading to the destruction of VOCs present. Afterburners employ a burner system (not necessarily used continuously).
- Regenerative afterburners, also called regenerative thermal oxidisers (RTOs), employ a regenerative system to utilise the thermal energy in the gas and carbon compounds using refractory support beds. A manifold system is needed to change the direction of the gas flow to clean the bed.
- In catalytic afterburners, also called catalytic thermal oxidisers (CTO), where the decomposition is carried out on a metal catalyst surface at lower temperatures, typically from 350 °C to 400 °C.
- Furnaces designed to burn off-gases, e.g. excess CO, to recover energy.
- The uptake shaft or exit portion of a furnace can be used as an afterburner if additional oxygen is added at this point.

Afterburners destroy organic compounds including PCDD/F by thermal oxidation. Further energy is needed, which results, depending on the source of energy used, in the emission of CO_2 , NO_x and SO_2 .

Afterburners are particularly useful in de-oiling and decoating operations, which can produce a high concentration of organic compounds. The presence of these components in a furnace

produces a high volume of combustion products and would result in a very short residence time in the furnace and therefore the emission of partially combusted gases.

Installations that are correctly designed, constructed and sized for the particular application are techniques to consider to remove VOCs, PCDD/F, organic or carbon particles or combustible gases such as CO or H₂. Heat recovery should be used where possible. The main requirements for effective combustion in an afterburner are as follows:

- Sufficient residence time in the combustion chamber or regenerative system; this must be long enough in the presence of sufficient oxygen to ensure complete combustion. A destruction efficiency of 99 % will usually require a residence time of two seconds at the relevant temperature, depending on the presence of chlorinated compounds. Lower residence times and temperatures may also result in the complete destruction of VOCs and PCDD/F, but this should then be demonstrated at a local level under real operating conditions. Gases should be cooled rapidly through the temperature window of PCDD/F reformation. Turbulence is necessary to provide efficient heat and mass transfer in the combustion zone, and to prevent cool spots. This is usually achieved using burners that generate a swirling combustion flame, and by incorporating baffles in the combustion chamber.
- An operating temperature of 200–400 °C above the autoignition temperature of the most stable substance, so minimum operating temperatures are above 850 °C. Where the gas stream contains chlorinated substances, temperatures must be increased to 1100–1200 °C, and rapid flue-gas cooling is required to prevent the reformation of PCDD/F.
- Operation of catalytic units at lower temperatures. Flares require turbulence, air, and an ignition source. If necessary, supplementary fuel can be added.
- Microprocessor control of the air to fuel ratio in the burners, to optimise combustion.
- Demonstration of the performance of the combination of equipment, operating temperature and residence time, to show that effective destruction of the materials present in the feed gas has taken place.

Achieved environmental benefits

Reduction of organic compounds emissions.

Environmental performance and operational data

Performance data are given in the metal-specific chapters.

Cross-media effects

Potential increase in energy use if the heat generated cannot be used.

Technical considerations relevant to applicability

Information can be found in the metal-specific chapters.

Economics

The processes are known to be operating economically and costs, where they are available, are reported in Annex 13.3 of this document and in the metal-specific chapters.

Driving force for implementation

Reduction of emissions.

Example plants

Information can be found in the metal-specific chapters.

Reference literature

[196, Finkeldei, L. 1999], [226, Nordic Report 2008], [211, VDI 2003], [212, VDI 1995], [214, VDI 2005], [103, COM 1998], [233, COM 2008]

2.12.5.2.2 Wet gas scrubber

Description

In the wet scrubbing process, gaseous compounds are dissolved in a solution. Downstream of the wet scrubber, the flue-gases are saturated with water and a separation of the droplets is required before discharging the flue-gases. The resulting liquid has to be treated by a waste water process and the insoluble matter is collected by sedimentation or filtration.

Technical description

Wet scrubbing systems are used in the industry to remove gaseous components at low concentrations, primarily to remove particles (see Section 2.12.5.1.6) but also to control temperature (by adiabatic cooling). Whilst the basic technology for these applications is similar, the design criteria for dust and gaseous component removal are very different. Wet scrubbing systems are often used for all three processes simultaneously and so the design is inevitably a compromise and significant cross-media effects, such as the production of additional waste water, may result depending on the application.

Various scrubbing media are used ranging from seawater to alkali solutions. The application for which a scrubber is used determines the factors that should be measured to monitor performance. The parameters that are used include: pressure drop and scrubbing liquid flow, temperature, turbidity, conductivity and pH. Potentially significant cross-media effects exist and need to be taken into account locally.

Scrubbers that are correctly designed, constructed and sized for the particular application are techniques to consider to remove low concentrations of sulphur dioxide (less than 1 %) and other acid gases such as HF and HCl that may be produced.

Wet scrubbers should incorporate a monitoring system if possible for pressure drop, scrubbing liquid flow and pH, and the scrubbed gases should exit the scrubber to a mist eliminator. Weak acid scrubbing liquid produced by scrubbers should be reused, recovered if possible, or treated to reduce emissions to water.

Achieved environmental benefits

Reduction of dust, metals and other compounds emissions.

Environmental performance and operational data

Performance data are given in the metal-specific chapters.

Cross-media effects

- Increase in energy use.
- Waste water is produced that needs additional treatment to prevent the discharge of metals to water.

Technical considerations relevant to applicability

Information can be found in the metal-specific chapters.

Economics

The processes are known to be operating economically and costs, where they are available, are reported in Annex 13.3 of this document and in the metal-specific chapters.

Driving force for implementation

Reduction of emissions.

Example plants

Information can be found in the metal-specific chapters.

Reference literature

[11, Hatch Associates Ltd 1993], [13, HMIP (UK) 1994], [226, Nordic Report 2008], [103, COM 1998].

2.12.5.2.3 Dry and semi-dry scrubbers

Description

Dry powder or a suspension/solution of alkaline reagents is introduced and dispersed in the waste gas stream. The material reacts with the sulphur gaseous species to form a solid, which has to be removed by filtration (bag filter or electrostatic precipitator). The use of a reaction tower improves the removal efficiency of the scrubbing system.

Technical description

Adsorption techniques such as dry scrubbing are used to absorb acid gases and adsorb metallic or organic compounds. Lime, magnesium hydroxide, limestone, zinc oxide and alumina are frequently used for both applications. Dual alkaline scrubbers are used elsewhere in the world. Activated carbon (or coke) is used to remove metal (mercury) and organic substances, for which it is usually more effective.

Adsorption is achieved using packed towers or by injecting the reagent into the gas stream and using a reactor tower. Fabric filters are most frequently used downstream to collect the partially reacted scrubbing medium and provide a further surface area for further absorption to take place. The scrubbing medium can be recycled several times within the scrubbing network to allow full use of the absorptive and adsorptive capacity. In the case of alumina and zinc oxide, they are subsequently used in the main process. Fluorides absorbed by alumina are recovered by the electrolytic process.

A variant on dry scrubbing is semi-dry scrubbing. In this case, a slurry of the reactant (usually lime) is injected into a reactor with the gas stream. The water is evaporated, provided the gas temperature is high enough, and the gaseous components can react with the particles. The particles of the reacted reagent are then removed from the gas stream. Dry scrubbing is often less effective than wet or semi-dry scrubbing, particularly with less reactive gases such as SO₂. The effectiveness of the reactant is often related to the reactivity of the reagent and suppliers of lime can often produce material at a reactivity that is suitable for certain applications.

When these processes are used to remove SO₂, they are known as flue-gas desulphurisation (FGD) techniques. They are used to reduce the SO₂ content of gases from anode furnaces and other sources with a low SO₂ content and for tail gas scrubbing of the gases from a sulphuric acid plant. Gypsum is produced when wet methods are used and can be sold in some circumstances.

Scrubbers using the correct reagent that are correctly designed, constructed and sized for the particular application are techniques to consider to remove low concentrations of sulphur dioxide (less than 1 %) and other acid gases such as HF and HCl that may be produced. Dry scrubbers using activated carbon are techniques to consider to remove organic matter such as PCDD/F or to remove mercury. Scrubbers should also use one or more of the following techniques depending on the application.

- Dry and semi-dry scrubbers should incorporate suitable mixing and reaction chambers.
- Particles generated in the reaction chamber should be removed in a fabric filter or ESP.
- The partially reacted scrubbing medium can be recycled to the reactor.
- The spent scrubbing medium should be used in the main process, if possible. For example, alumina and zinc oxide can be used in their respective processes.
- Semi-dry scrubbers should incorporate a mist eliminator, if mists are produced.

Achieved environmental benefits

Reduction of dust, metals and other compounds emissions.

Environmental performance and operational data

Performance data are given in the metal-specific chapters.

Cross-media effects

- Increase in energy use.
- Waste may be produced if the collected dust cannot be returned to the process.

Technical considerations relevant to applicability

Information can be found in the metal-specific chapters.

Economics

The processes are known to be operating economically and costs, where they are available, are reported in Annex 13.3 of this document and in the metal-specific chapters.

Driving force for implementation

- Reduction of emissions.
- Raw material savings if dust can be returned to the process.

Example plants

Information can be found in the metal-specific chapters.

Reference literature

[11, Ltd 1993], [13, HMIP (UK) 1994], [217, VDI 2004], [226, Nordic Report 2008], [103, COM 1998], [233, COM 2008]

2.12.5.2.4 Gas recovery systems

Description

In addition to the use of wet, dry and semi-dry scrubbing systems to remove the gaseous components reported above, this industry makes extensive use of recovery systems to recover gases from process gas streams.

Technical description

HCl can be absorbed in water, and SO₂ or NO_x can be absorbed in water or hydrogen peroxide.

The following examples are used in the industry to close the material cycles.

- The hydrochloric acid loop: for processes involving dissolution, where hydrochloric acid (HCl) is used in combination with excess chlorine. By using evaporation and collection in water, an azeotropic acid (in concentrations of about 20 wt-%) is obtained. This is reused in different parts of the process.
- The nitric acid loop: silver and palladium are often dissolved in nitric acid (HNO₃). A significant quantity of nitrogen oxide off-gases (NO and NO₂) can be captured with oxygen or hydrogen peroxide in special cascade scrubbers. The long time needed to oxidise small quantities of NO and the reduction of gas absorption by exothermic reactions cause problems. Therefore cooling and several combined scrubbers are

necessary to reach the limit values and to avoid brown fumes arising from the stack. The resulting nitric acid from the first scrubber usually has concentrations of about 45 wt-% and can be reused in several processes. Residual nitrogen oxides can be removed by catalytic means, such as selective or non-selective catalytic reduction, if very high NO_x concentrations occur continuously [161, Bobeth, A. 1999].

- The chlorine loop: chlorine is used in wet processes to dissolve metals, and in dry chlorination steps at elevated temperatures to refine them. In both cases, closed systems are used, e.g. using U-tubes with water and sealed electrolytic cells. Chlorine gas can be recovered or hypochlorite solutions produced. Hypochlorite is also used as an oxidising agent in scrubber solutions for various refining processes.
- The ammonium chloride loop: the relatively low solubility of ammonium chloride (NH₄Cl) in evaporated solutions at room temperature makes it possible to reuse crystalline precipitates of this salt.

Achieved environmental benefits

Reduction of acid gases and other compounds emissions.

Environmental performance and operational data

Performance data are given in the metal-specific chapters.

Cross-media effects

- Increase in energy use.
- Waste water is produced that needs additional treatment to prevent the discharge of metals to water.

Technical considerations relevant to applicability

Information can be found in the metal-specific chapters.

Economics

The processes are known to be operating economically and costs, where they are available, are reported in Annex 13.3 of this document and in the metal-specific chapters.

Driving force for implementation

- Reduction of emissions.
- Raw material savings if dust can be returned to the process.

Example plants

Information can be found in the metal-specific chapters.

Reference literature

[11, Hatch Associates Ltd 1993], [13, HMIP (UK) 1994], [103, COM 1998].

2.12.5.2.5 Oxy-fuel firing

Description

The technique involves the replacement of the combustion air with oxygen, with the consequent elimination/reduction of thermal NO_x formation from the nitrogen entering the furnace. The residual nitrogen content in the furnace depends on the purity of the oxygen supplied, on the quality of the fuel, and on the potential air inlet.

Technical description

The production stages usually rely on high temperatures but are also associated with the use of oxygen. This reduces the partial pressure of nitrogen in the flame and reduces nitrogen oxide formation, provided that nitrogen is not present in great amounts in the very hot areas. Typical levels for the emissions of nitrogen oxides for secondary copper are reported to be in the range of 20 mg/Nm³ to 400 mg/Nm³, depending on the furnace and type of operation. For NO_x, the

use of highly efficient processes (e.g. Contimelt) requires a balance to be established locally between energy use and achieved value. Other furnaces in the secondary aluminium sector that use oxy-fuel burners can also show a reduction in NO_x, the range for these processes is 50 mg/Nm³ to 500 mg/Nm³.

Achieved environmental benefits

Prevention of nitrogen oxides emissions.

Environmental performance and operational data

The use of pure oxygen in a burner leads to a reduction in the partial pressure of nitrogen in the flame and therefore thermal NO_x formation may be reduced. This may not be the case with oxygen enrichment in or near the burner, or if there is significant leakage of air into the furnace, as the higher gas temperature may promote thermal NO_x formation. In the latter case, oxygen can be added downstream of the burner to reduce this effect and maintain the improvement in the melting rate. Table 2.14 shows emissions of NO_x from several processes.

Table 2.14: Emissions of nitrogen oxide from several processes

Production site	Emission source	NO _x range (mg/Nm ³ as NO ₂)	Comment
Aurubis, Lünen, DE Secondary copper	Anode furnace Cu	100–350	Upper range is the ELV
Aurubis, Lünen, DE Secondary copper	KRS furnace	10–100	Oxy-fuel
Brixlegg, AT Secondary copper	Shaft furnace	21–300	Oxy-fuel
AMAG, AT Aluminium	Reverberatory furnace	15–310	Oxy-fuel
AMAG, AT Aluminium	Rotary furnace	10–157	NR
Unnamed DE Aluminium	Swarf dryer	40–350	Upper range is the ELV
AMAG, AT Aluminium	Swarf dryer	69–101	NR
AMAG, AT Aluminium	Tilting rotary furnace	11–36	Oxy-fuel
Unnamed DE Secondary lead	Secondary smelter	< 50	NR
Affinage de Lorraine, FR Aluminium production	Rotary furnaces	28–160	Oxy-fuel
Elkem, Thamshavn, NO Ferro-alloys	EAF	230–400	NR

NB: NR = Not reported.
 Source: [234, UBA (D) 2007], [194, Mezger, G. 1999], [256, Winter 2007], [249, Austria, Brixlegg 2007],
 [276, Schmitt G. 2008], [233, COM 2008]

Cross-media effects

No information provided.

Technical considerations relevant to applicability

Oxy-fuel firing is a technique that can be applied to most of the combustion and pyrometallurgical processes in use. The full benefit is achieved with new plants, where the combustion chamber and abatement systems can also be designed for lower gas volumes. The technique is also applicable to existing plants and can in many cases be retrofitted.

Economics

The economic advantages of oxy-fuel firing are mainly related to improvements in terms of the production rate. In the secondary aluminium sector in 1999, fixed costs were around EUR 145/t for two furnaces (22 561 tonnes produced/year). The higher productivity allowed by oxy-fuel burners would result in a cut in these costs to around EUR 122/t (22 651 x 145/27 000). There is therefore a potential saving of EUR 23/t for a production rate of 27 000 t/yr.

Some data on costs involved in oxy-fuel firing for secondary aluminium production are given in Table 2.15.

Table 2.15: Data on costs involved in oxy-fuel firing for secondary aluminium production

Parameter	Benefits/costs	Comment
Melting time	- 2.45 h/charge	Reduced batch melting time
Productivity	+ 0.84 t/h	Increased productivity of the furnace
Gas consumption	- 80 m ³ /t (tonne of oxygen)	Reduced consumption of gas
O ₂ consumption	+ 126 m ³ /t	Additional consumption of oxygen

Source: [276, Schmitt G. 2008]

Driving force for implementation

- Prevention of emissions.
- Energy savings.

Example plants

Plants in DE, AT, FR, BE and UK.

Reference literature

[234, UBA (D) 2007], [194, Mezger, G. 1999], [256, Winter 2007], [249, Austria, Brixlegg 2007], [276, Schmitt G. 2008], [122, ETSU 1994], [103, COM 1998].

2.12.5.2.6 Techniques to remove hydrocarbons and VOCs

Description

The techniques used to remove or destroy VOCs are afterburners (see Section 2.12.5.2.1), wet scrubbers (see Section 2.12.5.2.2), dry scrubbers (see Section 2.12.5.2.3) biofilters and bioscrubbers.

A biofilter consists of a bed of organic material, where pollutants from waste gas streams are biologically oxidised by naturally occurring microorganisms.

A bioscrubber combines wet gas scrubbing (absorption) and biodegradation, the scrubbing water containing a population of microorganisms suitable to oxidise the noxious gas components.

Technical description

TVOC and VOCs are produced by poor combustion and during various operations such as storage of hydrocarbons, the removal of CO and hydrocarbons produced during process operations, degreasing of components, solvent extraction processes and from the breathing of tanks used to store solvents and fuel. Materials may be aromatic, aliphatic, chlorinated organic or water-based. The ecotoxicity varies and this needs to be taken into account in order to use the most benign material and to determine the correct abatement system that should be used on a site-by-site basis. Containment is practised to prevent emissions, and mixers/settlers can be used that minimise contact with air. Solvent or fuel vapours need to be extracted and removed from the exhaust gases.

Combinations of the techniques are used where there is a wide range of hydrocarbons present. Biofilters and reactors are also used [156, VDI 2008]. Activated carbon filters and chiller/condenser systems are used which allow the material to be recovered for reuse. In one solvent extraction process, ventilation air is cooled and removes the solvent down to a level of 0.2 kg per tonne of cobalt produced. VOCs can also be emitted during the delivery of solvents, etc. Back-venting of displaced gases is used to minimise the emission of VOCs.

Heat recovery should be used where possible.

VOCs can be emitted if oily material is used as feed. VOCs may also be emitted from solvent degreasing or solvent extraction processes.

Achieved environmental benefits

Reduction of hydrocarbon and VOC emissions.

Environmental performance and operational data

Performance data are given in the metal-specific chapters.

Cross-media effects

Increase in energy use if the heat generated cannot be used.

Technical considerations relevant to applicability

Information can be found in the metal-specific chapters.

Economics

Several RTOs are operating viably. Costs, where they are available, are reported in Annex 13.3 of this document and in the metal-specific chapters.

Driving force for implementation

- Reduction of emissions.
- Raw material savings.

Example plants

Information can be found in the metal-specific chapters.

Reference literature

[212, VDI 1995], [234, UBA (D) 2007], [242, Infomil 2008], [226, Nordic Report 2008], [157, Winter, B. et al. 1999], [103, COM 1998], [233, COM 2008], [348, Solios 2010].

2.12.5.2.7 Removal of other impurities

In addition to their interference with the recovery of sulphuric acid and sulphur dioxide, other non-ferrous metals that are present in the ores and concentrates have an adverse environmental impact. They need to be removed if they have not been already. They also have a value and so they are recovered separately from the metal of prime interest. Additional purification stages are therefore used to remove and recover them and these are reported in the metal-specific chapters.

2.12.5.2.7.1 Other metals

Description

Technical description

Pyrometallurgical processes are used to remove impurities from the desired metal by volatilising and/or slagging other metals. For example, zinc, bismuth, lead, tin, cadmium, arsenic and gallium may be volatilised under the operating conditions in the furnace and are fumed from the melt. The choice of operating temperature influences this stage of the process, and these metal

oxides can be collected using an appropriate dust removal technique. The metals are then recovered from the collected flue-dusts in a number of ways. Slag cleaning furnaces and slag fuming processes are also operated to remove volatile metals that are collected as flue-dusts. These flue-dusts and other residues therefore form the raw materials for a variety of metals.

Volatile metals and their oxides are also found in dusts and residues from other processes, for example, in dust from steelmaking. These residues provide the raw material for other processes to recover zinc and other volatile metals. In these processes, a rotary kiln (Waelz kiln) or an Ausmelt/ISASMELT furnace is used to fume the metal and enrich zinc and lead in a mixed oxide, which can then be recovered in other pyrometallurgical processes.

Tanks and other equipment used in hydrometallurgical plants are mostly ventilated to atmosphere to ensure a safe workplace. This ventilation air may contain an acid mist that contains metal compounds from the solution. Removal techniques comprise wet scrubbers or demisters. The demister elements are placed in the gas stream in the vent stack or on top of the cooling towers and the separated solution flows back into the main reservoir.

Achieved environmental benefits

- Prevention and reduction of metals emissions.
- Recovery of metals.

Environmental performance and operational data

Information can be found in the metal-specific chapters.

Cross-media effects

- Increase in energy use.
- Waste or waste water may be produced if the collected material cannot be returned to the process.

Technical considerations relevant to applicability

Information can be found in the metal-specific chapters.

Economics

The processes are known to be operating economically and costs, where they are available, are reported in Annex 13.3 of this document and in the metal-specific chapters.

Driving force for implementation

- Prevention and reduction of emissions.
- Raw material savings.

Example plants

Information can be found in the metal-specific chapters.

Reference literature

[226, Nordic Report 2008], [103, COM 1998]

2.12.5.3 Techniques to reduce PCDD/F emissions

In this document, dioxins and furans are referred to together as PCDD/F.

Description

The techniques to consider include both primary techniques (such as improving the combustion conditions, removing organic compounds from the feed or modification of the furnace charging systems) and end-of-pipe techniques (such as efficient dust filtration, addition of activated carbon or afterburners).

Technical description

PCDD/F are formed by gas phase reactions with chlorinated organic precursors. Apart from a carbon source, which is always present, only small amounts of chlorine in the input materials (30–300 ppm in typical ores and a few ppm in metals) or in the fuels (commercial coke has, for example, a chlorine content of around 0.05 wt-%) are sufficient for PCDD/F to form. Processes prone to PCDD/F formation include, for instance, combustion processes, ore sintering, metal smelting and, hence, also pyrometallurgical processes. The greater part of PCDD/F formation occurs through de novo synthesis as the off-gas is being cooled through the temperature window of approximately 400 °C to 200 °C in the presence of reactive carbon, chlorine, oxygen and a catalytically active metal like copper.

The main sources of PCDD/F formation in non-ferrous metallurgy are [306, COM 2007]:

- smelting of secondary copper, aluminium and lead (via dirty input materials, which contain chlorine and organics, no adequate operation conditions or gas cleaning);
- melting and alloying of metals, in particular in the presence of copper and when heated with gas under substoichiometric conditions.

Minor sources of PCDD/F formation are:

- foundries;
- smelting of secondary copper, aluminium and lead (using clean input materials, optimised operation and/or flue-gas cleaning).

Sources that are not well-known are:

- other sintering processes, because they are applied on a relatively modest scale to non-ferrous ores;
- sources that are probably negligible, i.e. other processes fitted with well-designed, well-operated thermal or catalytic post-combustion or deNO_x catalysis, and without subsequent heat recovery.

However, whether and to what extent PCDD/F will be emitted with the off-gas not only depends on the fuels used and materials processed (e.g. metals with catalytic properties), but also primarily on the process control (mass transfer conditions) and the specific off-gas conditions (e.g. temperature, residence time in the different temperature windows, SO₂ content). PCDD/F are also relevant to the production of metals in processes that need chlorination, such as the electrolytic production of magnesium from seawater and dolomite.

This industry relies on sources of secondary raw materials from the scrap industry. Although there are agreed scrap grades, the impurities present may lead to the formation of PCDD/F during incomplete combustion or by de novo synthesis. The presence of PCDD/F in EAF dust and the presence of polychlorinated biphenyls on transformer scrap and other materials are potential direct sources of PCDD/F.

The presence of oils and other organic materials on scrap or other sources of carbon (partially burnt fuels and reducing agents, such as coke) can produce fine carbon particles which react with inorganic chlorides or organically bound chlorine in the temperature range of 250 °C to 500 °C to produce PCDD/F. This process is known as de novo synthesis and is catalysed by the presence of metals such as copper or iron. Preselection or treatment of the feed material to minimise the amount of precursors or organic matter is therefore a very important measure to prevent the formation of PCDD/F.

High levels of SO₂ are reported to inhibit de novo synthesis in municipal solid waste incinerators where the formation of CuCl₂, which is said to act as a catalyst for de novo synthesis, is inhibited by the formation of CuSO₄ [278, Hunsiger et al 2007]. This effect might be applicable in the non-ferrous metals sector and could influence the sequence of SO₂ removal.

Although PCDD/F are destroyed at high temperatures (above 850 °C) in the presence of oxygen, the process of de novo synthesis is still possible as the gases are cooled through the 'reformation window'. This window can be present in abatement systems and in cooler parts of the furnace, e.g. the feed area. Care is taken in the design of cooling systems to minimise the residence time in the window, to prevent de novo synthesis. Sufficient oxygen should be present in the hot gases and oxygen injection can be used to ensure complete combustion. PCDD/F are easily adsorbed onto solid matter and may be collected by all environmental media such as dust, scrubber solids and filter dust.

Possible methods for reducing the emissions of PCDD/F are given below.

- Active carbon technique: activated carbon added to calcium hydrate (or lime, sodium bicarbonate, etc.) has proven to be an effective adsorbent in secondary aluminium melting plants using feedstock that contains metal with organic contamination. Activated carbon is also used in a primary copper smelter where a number of other metals are also recovered, the fine-grained activated carbon binds the PCDD/F and is removed in fabric filters or ESPs. The quantity and composition of the additive depend to a large extent on the process conditions and the origin and composition of the input materials. To reduce the need for an adsorbent, it may be useful to return all or some of the filter dust to the process. Moreover, the adsorbent required must be adapted to the emission behaviour of the plant. With respect to sorbent consumption, optimised solutions must be individually tested in relation to the smelting technology employed in each case.
- Combustion conditions: improvements to the combustion conditions can include the use of enriched air or pure oxygen, enhanced or improved mixing of oxygen with combustibles, and raising of the combustion temperature or residence time at high temperatures.
- Thermal post-combustion or afterburner: incinerating the off-gas followed by a rapid quench of the hot gas also minimises PCDD/F formation. Catalytic oxidation systems are also available for the destruction of PCDD/F.
- Reduction of the organic contents: removing the organic contaminants (e.g. machining oil, coatings) of the feed is also a measure to reduce PCDD/F formation.
- Oxygen injection in the upper zone of a furnace: the process concerned has no room to allow an afterburner to be fitted. There are some restrictions on the degree of gas mixing achieved but the overall performance is acceptable.

Modification to furnace charging systems: modifications have been made to give small, even additions of raw materials in semi-closed furnaces. This reduces furnace cooling during charging, maintains higher gas temperatures, optimises the process and prevents the reformation of PCDD/F [233, COM 2008]

- High-efficiency dust filtration to remove the dust and PCDD/F: PCDD/F may be absorbed onto dust and can be removed using high-efficiency dust filtration. It has been reported that fabric filters that incorporate a catalytic layer are available.

Achieved environmental benefits

Reduction of PCDD/F and CO emissions.

Environmental performance and operational data

Performance data are given in the metal-specific chapters.

Cross-media effects

- Increase in energy use (needed to produce oxygen).
- The collected dusts may have high PCDD/F concentrations and may need to be disposed of or treated carefully by returning dusts to the furnace.

Technical considerations relevant to applicability

Information can be found in the metal-specific chapters.

Economics

No data have been reported for all processes but the technique used in France for secondary aluminium reports the following costs:

- Total investment costs were around EUR 485 000 for both oxy-fuel burners and the lignite coke injection. The cost of coke injection alone was EUR 183 000.
- Measurement and control operational costs were EUR 36 400.
- There were also cost savings that amounted to EUR 23 per tonne, which represents EUR 300 000/year. Consequently, the payback time is less than two years.

Driving force for implementation

Compliance with environmental permits.

Example plants

Information can be found in the metal-specific chapters.

Reference literature

[121, Rentz, O. et al. 1999], [234, UBA (D) 2007], [256, Winter 2007], [249, Austria, Brixlegg 2007], [276, Schmitt G. 2008], [178, UBA (A) 1998].

2.12.5.4 Techniques to reduce sulphur dioxide emissions

The following sections describe the techniques to consider in the determination of BAT for the removal of sulphur dioxide from non-ferrous metal smelter exhaust gas, in addition to those reported in the LVIC-AAF BREF [339, COM 2007].

2.12.5.4.1 Double contact/double absorption sulphuric acid plants operating under varying gas conditions**Description**

In this process, the sulphur dioxide in the gas is converted to sulphur trioxide in a contact process when the gases are passed through a vanadium pentoxide catalyst bed. Sometimes the catalyst is doped with caesium oxide, which improves performance, particularly when the SO₂ concentration is low and variable or when the temperature is low. Single and double contact/double absorption plants are used, the latter being the more commonly applied.

Technical description

The double contact/double absorption sulphuric acid plant comprises a gas cleaning and washing section, and a contact plant with four passes. It uses a modern catalyst promoted by caesium oxide.

Achieved environmental benefits

Reduction of SO₂ emissions.

Environmental performance and operational data

Data from some sulphuric acid plants operating under varying gas conditions are shown in Table 2.16. A high conversion rate for sulphur dioxide is achieved, resulting in reduced emissions (see Table 2.17). Conversion rates between 99.7 % and 99.85 % are achieved by a recently upgraded installation over a long averaging period.

[331, Chmielarz A. et al. 2009]

Table 2.16: Sulphuric acid plants operating under varying gas conditions

Sulphuric acid plant data (with additional abatement measures where shown in Process type and plants operating normally)											
Company	SO ₂ source	Line	Capacity (t/d)	Process type	Number of beds	Cs-promoted catalyst	Inlet SO ₂ vol. (%)	Conversion rate (%)	SO ₂ year avg. (mg/m ³)	SO ₂ day avg. (mg/m ³)	SO ₂ max. 1/2 h avg. (mg/m ³)
Atlantic Copper, Huelva	Flash smelter and PS converter	1	2200	Double contact/ Double absorption	5	Partial fourth bed	5–11.5	99.7–99.83	500–00	400–800	Up to 1000
		2	600		4	Last bed	5.5–8.5	99.7	500–700	400–800	Up to 1200
		3	1300		5	None	5–10	99.7–99.8	500–800	Up to 900	Up to 1200
KGHM Głogów 1	Hoboken converter	NA	700	Double contact/ Double absorption	4	None	4.5–8	99.8	300–800	NR	800
KGHM Głogów 2	Flash furnace (for Cu), Kaldo furnace (for Ag)	NA	900	Double contact/ Double absorption	4	None	6–8	99.9	300–800	NR	800
Aurubis AG, Hamburg	Flash smelter and PS converter	1	1300	Double contact/ Double absorption	4	First and last bed	5–12	99.7–99.8	500–800	Up to 900	Up to 1200
		2	1300		4	First and last bed	5–12	99.7–99.8			
		3	1300		5	First bed	5–12	99.8			

NB: NA = Not applicable; NR = Not reported.

Operational data are given in Table 2.17. SO_x concentrations vary between 5 % and 12 %.

Table 2.17: Performance data for a sulphuric acid plant operating under variable conditions

Component	Measured values	
Off-gas volume:	320 000	(Nm ³ /h)
SO ₂	100–770	(mg/Nm ³)
SO ₃	20–50	(mg/Nm ³)
NO _x (as NO ₂)	20–45	(mg/Nm ³)
Cl ⁻ (as HCl)	2–7	(mg/Nm ³)
F ⁻ (as HF)	1–4	(mg/Nm ³)
Residual dust	< 2	(mg/Nm ³)
Residual dust range	1–7	(mg/Nm ³)
<u>Component ranges:</u>		
Cd	< 0.01–0.02	(mg/Nm ³)
Hg	< 0.01–0.07	(mg/Nm ³)
Tl	< 0.01–0.02	(mg/Nm ³)
As	< 0.01–0.1	(mg/Nm ³)
Se	< 0.01–0.02	(mg/Nm ³)
Sb	< 0.01–0.03	(mg/Nm ³)
Pb	< 0.01–0.15	(mg/Nm ³)
Cu	< 0.01–0.09	(mg/Nm ³)
PCDD/PCDF	0.001–0.01	(ng I-TEQ/Nm ³)
<i>Source:</i> [238, ECI 2012], [228, COM 2007] [233, COM 2008], [231, COM 2007]		

For existing plants with variable SO₂ inlet concentrations, > 99.7 % conversion is achieved. The techniques to upgrade existing sulphuric acid plants that were reported in the LVIC-AAF BREF [339, COM 2007] have been examined and new data have been supplied by Lurgi (Outotec) [344, Outotec 2010] They report that the addition of a fifth bed achieves a similar improvement to conversion as the change to a caesium-promoted catalyst in the final bed of a four-pass plant.

In the washing section 12–15 m³/h of weak acid (5 % H₂SO₄) is produced and it is usually sent for neutralisation, but in some circumstances it could be used for thermal decomposition of the acid bleed.

Cross-media effects

The production of solid wastes and a weak acid that require treatment and/or disposal.

Technical considerations relevant to applicability

These techniques are applicable to most existing installations.

Economics

The cost in 2002 for a zinc concentrate roaster (550 t/d of zinc concentrate), a waste heat boiler and a water treatment plant, a gas-cleaning plant, weak acid treatment and a new double contact/double absorption sulphuric acid plant producing 148 000 t/yr of acid was EUR 40 million.

Other costs for changes to existing plants in the copper sector are given in Table 2.18.

Table 2.18: Costs for changes to existing sulphuric acid plants

Year	Technique	Estimated costs	Source
2009	Addition of 5th bed (2+2 to 3+2) to an existing plant with a capacity of 120 000 m ³ /h and an 11 % SO ₂ inlet concentration with a blower capacity increase	EUR 10 million	Updated costs provided by Lurgi (Outotec)
2009	Change of catalyst in the 4th bed to incorporate caesium-promoted catalyst to two existing plants with capacities of 120 000 m ³ /h and an 11 % SO ₂ inlet concentration – excluding costs for changing the heat exchanger	EUR 800 000	Updated costs provided by Lurgi (Outotec)
2009	H ₂ O ₂ scrubber for an acid plant producing 1 000 000 t/yr of acid	EUR 30 million	Updated costs provided by Lurgi (Outotec)

Driving force for implementation

- The production of sulphuric acid for sale.
- Required environmental performance.

Example plants

Hamburg (DE), Głogów (PL), and Huelva (ES).

Reference literature

[121, Rentz, O. et al. 1999], [331, Chmielarz A. et al. 2009], [253, Eurometaux 2008]

2.12.5.4.2 Upgraded sulphuric acid plants with lower SO₂ inlet concentration variations associated with non-ferrous metal production

Description

See below.

Technical description

A double contact/double absorption sulphuric acid plant is used to treat the off-gas from an Outotec flash smelting and flash converting furnace with an inlet concentration of 30–40 % SO₂. The plant has four passes, and intermediate absorption after the third pass. A modern catalyst is used. There is a heat recovery system, to recover heat in the form of steam, after the first pass.

Other installations in Sweden and the Netherlands use a five-pass acid plant. A significant reduction in the concentration of SO₂ is achieved (60–150 mg/Nm³ SO₂ in the tail gas, as an yearly average) without the use of tail gas scrubbing. The installations report that they are operating with a throughput that is below their designed capacity; the plant in the Netherlands reported emissions of 30–80 mg/Nm³ as an yearly average with an inlet gas concentration of 7 % SO₂. Other changes, such as optimising the sequence of gas flow through the passes and using a caesium catalyst in the first and final passes, optimise the performance [227, IZA Report 2008], [240, Nyrstar Budel 2008], [228, COM 2007], [233, COM 2008].

Some of the plants are reported to be operating below the designed capacity.

Achieved environmental benefits

Reduction of SO₂ emissions.

Environmental performance and operational data

Data from some upgraded sulphuric acid plants associated with non-ferrous metal production are shown in Table 2.19.

Table 2.19: Upgraded sulphuric acid plants with lower SO₂ inlet concentration variations associated with non-ferrous metal production

Sulphuric acid plant data (with additional abatement measures where shown in Process type and plants operating normally)										
Company	SO ₂ source	Capacity (t/d)	Process type	Number of beds	Cs-promoted catalyst	Inlet SO ₂ vol. (%)	Conversion rate (%)	SO ₂ year avg. (mg/m ³)	SO ₂ day avg. (mg/m ³)	SO ₂ max. 1/2 h avg. (mg/m ³)
Boliden Rönnskär	Roaster, smelter, flash smelter, PS converter	2000	Double contact/ Double absorption	5	Last bed	7–10.5	99.97	100–160	NR	NR
Umicore Hoboken	ISASME LT	360	Double contact/ Double absorption	4	Last bed	Min. < 1 Max. 7–10	> 99.7	80	140–180	Up to 300
KCM Plovdiv	Zn roaster	440	Double contact/ Double absorption	4	Last bed	6–7.5	99.8–99.85	140–280	NR	Up to 360
Nyrstar Budel	Fluidised bed roaster (zinc conc.)	1000	Double contact/ Double absorption	5	Yes	5–7.2 (low variation inlet conc.)	≤ 99.97	50–80	NR	NR

NB: NR = Not reported.

The maximum conversion of sulphur dioxide gives emissions in the range of 60 mg/Nm³ to 150 mg/Nm³ SO₂ in tail gas, as an yearly average.

For dilution to 14 % SO₂ at the drying tower inlet, and an yearly average flow of 171 300 Nm³/h, over 99.9 % conversion is achieved in modern installations. These plants rely on high, constant sulphur dioxide feeds and use caesium-doped catalyst.

In the Dutch plant, the low iron concentrate allows the calciner to be operated under steady-state conditions and this, combined with a very low variation in the sulphur content, allows an even concentration of SO₂ to be produced. This constant gas content assists the operation of the associated sulphuric acid plant at a high conversion efficiency. The plant is reported to be operating below the designed capacity.

In the Swedish plant, liquid SO₂ is also produced and this allows an even gas content to be maintained. The plant is also reported to be operating below the designed capacity.

Cross-media effects

There is a production of solid wastes and weak acid that require treatment and disposal.

Technical considerations relevant to applicability

These techniques are applicable to new or modernised installations with a low variation in inlet gas concentration.

Economics

No information provided but the plants are known to be operating viably.

Driving force for implementation

- The production of sulphuric acid for sale.
- Required environmental performance.

Example plants

Budel (NL), Rönnskär (SE), Hoboken (BE), and Plovdiv (BG).

Reference literature

[137, Riekkola-Vanhanen, M. 1999], [274, COM 2008], [253, Eurometaux 2008]

2.12.5.4.3 Production of liquid sulphur dioxide from off-gases with a high SO₂ content

Description

Sulphur dioxide is absorbed in cold water (e.g. cold seawater) followed by vacuum stripping and recovery as liquid sulphur dioxide.

Technical description

These processes are used in conjunction with a sulphuric acid plant to recover sulphur dioxide that is not dissolved. The potential for the production of liquid sulphur dioxide depends on the existence of a local market. The process to produce liquid sulphur dioxide is shown in Figure 2.30. Liquid sulphur dioxide is also produced in a cryogenic process.

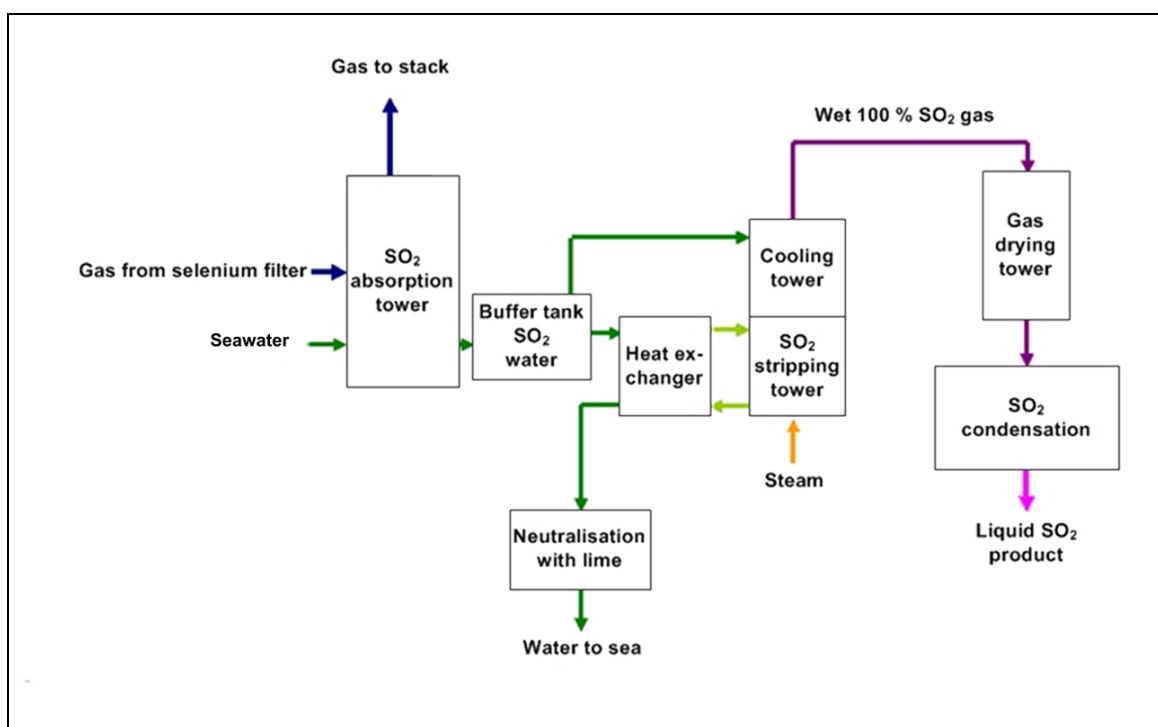

Figure 2.30: The process to produce liquid sulphur dioxide

Achieved environmental benefits

Reduction of SO₂ emissions.

Environmental performance and operational data

Provision of a supply of sulphur dioxide that can be used to maintain an even inlet concentration to a sulphuric acid plant. The yearly average emissions of sulphur dioxide are shown in Table 2.20.

Table 2.20: The yearly average emissions of sulphur dioxide from Boliden

Year	Tail gas concentration (mg/Nm ³)
2006	213
2007	155
2008	153
2009	124
<i>Source: [233, COM 2008]</i>	

Technical considerations relevant to applicability

Applicable to installations where there is a local market for liquid sulphur dioxide.

Economics

One plant is known to be operating viably.

Driving force for implementation

The production of sulphur dioxide for sale.

Example plants

Boliden (SE).

Reference literature

[233, COM 2008]

2.12.5.4.4 Use of flue-gas desulphurisation for off-gases with a low SO₂ content

Description

Dry and semi-dry scrubbers (see Section 2.12.5.2.3) used to remove SO₂ are known as flue-gas desulphurisation (FGD) techniques.

Technical description

One of the most commonly applied FGD techniques is lime injection (several examples are given in the metal-specific chapters, e.g. see Section 3.3.3.9).

In some cases (e.g. Waelz furnace installation or an ISF when using Waelz oxide), the use of another FGD system composed of a scrubber, absorber and a system to contact the gases with the circulating suspension of limestone was also reported. The scrubber operates in a co-current phase for cooling, moistening and partial desulphurisation of the gases. This is followed by a countercurrent absorption column to reduce the final SO₂ concentration to below the required level.

Gases containing sulphur dioxide are treated in a FGD unit that uses a slurry of milled calcium carbonate (limestone, < 40 microns) as a SO₂ sorbent to produce clean gypsum. Gases are cooled down, dedusted in a fabric filter and the gases are passed to the desulphurisation system. After desulphurisation, the gases are sent to a two-stage drift eliminator and then to the stack. Gypsum is recovered from the slurry produced by the FGD and is sold.

In this case, the circulating suspension of limestone is pumped from separate tanks equipped with mechanical stirrers; the scrubber tank also has an aeration system. The tanks are sized to allow complete reaction of the absorbed SO₂ with the CaCO₃ suspension, oxidation of sulphur compounds to sulphates, and the formation of a coarse crystalline residue of synthetic gypsum, CaSO₄·2H₂O. Compressed air is delivered to the scrubber tank through a pneumo-hydraulic aerator to improve the oxidation of sulphites to sulphates. The reaction slimes from the first absorption stage, containing mainly calcium sulphate (gypsum), are sent to a filtration system. The gypsum, after dehydration in a filtration press, is unloaded directly into a storage container located under the press, from where it is transported to a warehouse, and then sold.

Other scrubbing processes for gases with a low SO₂ content are described in Sections 2.12.5.2.2 and 2.12.5.2.3.

Achieved environmental benefits

Reduction of SO₂ emissions. SO₂ removal efficiencies range from 50 % to 95 %. Removal rates at the higher end of this range are only possible in ideal conditions in newly designed, dedicated installations.

Environmental performance and operational data

Performance data are given in the metal-specific chapters.

For the FGD system reportedly used in a Waelz furnace installation and in an ISF when using Waelz oxide, a final SO₂ concentration range of 100–500 mg/Nm³ is achieved with an FGD input containing 2–6 g of SO₂/Nm³. A final SO₂ concentration of 50–400 mg/Nm³ is reported as the best performance, [331, Chmielarz A. et al. 2009], [346, Eurometaux 2010].

Cross-media effects

- Additional use of energy and calcium carbonate.
- If the sale of clean gypsum is not possible then waste will be produced.

Technical considerations relevant to applicability

Applicable to new plants. When using existing gas-cleaning equipment with a fabric filter that is designed to remove process dust, it can be used to capture gypsum if the filter capacity allows for this. When a filter is already used, direct injection is possible when temperature, moisture content and contact time are sufficient. An existing filter installation might be insufficient, as the amount of dust increases drastically and thus it might need to be replaced.

The FGD system reported to be used in a Waelz furnace installation and in an ISF when using Waelz oxide is applicable to all processes that have a FGD input that contains 2–15 g SO₂/Nm³ (approximately 0.05–0.5 %) provided that there is a market for the gypsum that is produced.

Economics

Lime injection plants' investment costs are reported in the metal-specific chapters.

For the FGD system reportedly used in a Waelz furnace installation and in an ISF when using Waelz oxide, with a capacity of 85 000 Nm³/h and an average inlet SO₂ content of 15 g/Nm³, the capital cost in 2008 was PLN 14 million which is equivalent to EUR 4 million. The operating cost is approximately EUR 2100 per day.

Driving forces for implementation

Reduction of SO₂ emissions.

Example plants

- Lime injection: Hoboken (BE), Beerse (BE), Hamburg (DE), and Bergsöe (SE).
- Other FGD techniques: Miasteczko Śląskie and Bolesław (PL).

Reference literature

[331, Chmielarz A. et al. 2009], [346, Eurometaux 2010]

2.12.5.4.5 Polyether-based absorption/desorption process for sulphur capture from off-gases with a low SO₂ content (< 1 %)

Description

See below.

Technical description

The combination of a power station, a single contact sulphuric acid plant and a sulphur dioxide recovery process are used to minimise emissions to air of SO₂ from both the fuel and the metal concentrate and to recover energy in the form of heat and carbon monoxide.

Achieved environmental benefits

- The recovery of heat and CO.
- Reduction of SO₂ emissions.

Environmental performance and operational data

Blast furnace exhaust gases from a copper smelter have a relatively high concentration of carbon monoxide (around 10 %) and also contain heat from the process. The exhaust gases are therefore a valuable energy source but also contain SO₂. The gases are transferred to local power plants as additional fuel and to recover the heat content. Flue-gases emitted from the power plant therefore contain SO₂ from both the blast furnace and the fuel, and are treated further in a polyether-based absorption/desorption plant, which uses an absorption/desorption process to produce a gas that is rich in SO₂. This gas is converted to sulphuric acid in a single contact plant. This process results in a waste gas that contains less than 200–600 mg/Nm³ of SO₂, and this is emitted to air [238, ECI 2012]

The exhaust gases from the smelter conversion stage have a SO₂ concentration ranging from 5 % to 12 %. These are cleaned and then mixed with the strong gas from the polyether-based

absorption/desorption plant and diluted to 12 % and passed to the sulphuric acid plant. This plant produces sulphuric acid and an off-gas that contains 6–8 g/Nm³ of SO₂ which is then passed to the polyether-based absorption/desorption plant for recovery.

Cross-media effects

- Increase in energy use.
- The production of weak acid and waste water from the gas-cleaning section that require treatment.

Technical considerations relevant to applicability

This technique is applicable to specific types of concentrates that have low sulphur contents. A power plant is required nearby.

Economics

No details provided but reported to be expensive.

Driving force for implementation

Required environmental performance.

Example plants

Legnica (PL).

Reference literature

[238, ECI 2012]

2.12.5.5 Techniques to reduce mercury emissions

Description

Set of techniques to reduce mercury emissions to air.

Technical description

Mercury is volatile at the temperatures encountered in most abatement processes, and hence other techniques may be needed to remove it [25, OSPARCOM 1996] [136, Fugleberg, S. 1999].

In the case of mercury removal before a sulphuric acid plant, any residual mercury will be present in the acid that is produced; the product specification is normally < 0.1 ppm to 0.5 ppm and is equivalent to ~ 0.02 mg/Nm³ in the cleaned gas. All processes listed below are reported to achieve this.

- Boliden-Norzink process: this process is based on a wet scrubber using the reaction between mercuric chloride and mercury to form mercurous chloride (calomel), which precipitates from the scrubbing liquid. The process is placed after the washing and cooling step in the acid plant, so the gas is dust- and SO₃-free and the temperature is about 30 °C. The gas is scrubbed in a packed bed tower with a solution of HgCl₂. This reacts with the metallic mercury in the gas and precipitates it as calomel (Hg₂Cl₂). The calomel is removed from the circulating scrubbing solution and partly regenerated by chlorine gas to HgCl₂, which is then recycled back to the washing stage. The mercury product bleed is either used for mercury production or stored. Mercury chloride is a very toxic mercury compound and great care should be taken when operating this process.
- Bolchem process: this process is located in the acid plant, as in the Boliden-Norzink process, but the removal is effected by 99 % sulphuric acid. This acid comes from the absorption part of the acid plant and it oxidises the mercury at ambient temperature. The resulting acid that contains mercury is diluted to 80 % and the mercury is precipitated as sulphide with thiosulphate. After filtering off the mercury sulphide, the acid is returned to the absorption stage. No acid is therefore consumed in the process.

- Outotec process: in this process the mercury is removed before the washing step in the acid plant. The gas, at about 350 °C, is led through a packed bed tower where it is washed countercurrently with 90 % sulphuric acid at about 190 °C. The acid is formed *in situ* from the SO₃ in the gas. The mercury is precipitated as a selenium chloride compound. The mercury sludge is removed from the cooled acid, filtered and washed and sent to the production of metallic mercury. Part of the acid is then recycled to the scrubbing step. In a revision to this process, mercury is removed from the gases by washing with a solution of selenium ions, and selenium metal is produced along with mercury selenide.
- Sodium thiocyanate process: this process is used at a zinc roaster. The SO₂ gas is washed with a solution of sodium thiocyanate and the mercury is removed as a sulphide. Sodium thiocyanate is regenerated, the reaction is shown in the following formula:

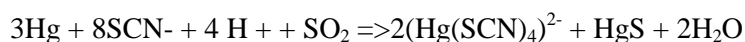

- Activated carbon filter (Lurgi process): this is an adsorption filter using activated carbon to remove mercury vapour from the gas stream.

The Boliden-Norzink and Outotec processes detailed above are most commonly used, but other processes have been reported elsewhere [25, OSPARCOM 1996] [330, Petola H. et al. 1985]

- Selenium scrubber: this is also based on a wet scrubber and uses the reaction between amorphous selenium in sulphuric acid and mercury to remove high concentrations of mercury vapour.
- Selenium filter: a dry scrubbing process which uses amorphous selenium to react with mercury vapour to form mercury selenide.
- Lead sulphide process: a dry scrubbing process using lead sulphide nodules to remove mercury from the gas stream.
- Tinfos/Miltec process: a mercury cleaning process, which is based on the oxidation of mercury in the off-gas using sodium hypochlorite. After oxidation in a washing tower, the mercury is precipitated as mercury sulphide (HgS) by the addition of disodium sulphide. The mercury sulphide is removed from the process in a press filter. The sludge that contains mercury is treated as hazardous waste and disposed of in a sealed disposal site. Mercury emissions are reduced by approximately 94 %. [226, Nordic Report 2008]
- Lurgi mercury cleaning process: the Lurgi mercury removal unit consists of an electrostatic precipitator to remove residual dust and tars, a gas heater, a packed bed absorber, a fan-damper system to control the gas flow through the unit, and extensive gas analysis nitrogen purge equipment to maintain low oxygen levels in the gas. The heater is required to warm the gases to the optimum temperature of 60–85 °C; lower gas temperatures result in lower reaction rates and moisture condensation in the packed bed, higher temperatures can result in sulphur being lost from the absorbent. Eramet commissioned a mercury removal unit in 2001 and reports trouble-free operation since then. Gas flow rates through the unit are around 15 000 Nm³/hour. The mercury absorption efficiency is 98 %. After allowing for plant start-ups, etc., 94 % of the total mercury in the raw gases is captured. The absorber mass is changed after about eight months of operation and is disposed securely. Only trace amounts of mercury are reported in the scrubber water [226, Nordic Report 2008]
- Boliden Contech process: selenium-coated spheres are used in a packed bed. The method works but experience is limited to the Scandinavian ferro-alloy industry.
- The Dow process: mercury is adsorbed onto pumice stones coated with lead sulphide.

Two other processes are available to reduce the mercury content in sulphuric acid produced during the production of non-ferrous metals, but their use is based on a need to improve the quality of the acid rather than on environmental effects.

- SuperLig ion exchange process: this process uses ion exchange to remove mercury from the product acid and achieves a concentration of mercury of < 0.5 ppm.

- Potassium iodide addition to the acid: this should be at least 93 % strength, at a temperature of about 0 °C. Mercury iodide, HgI₂, is then precipitated.

If the non-ferrous metal production does not include a sulphuric acid plant, the techniques usually applied to reduce mercury emissions are the selection of raw materials and the injection of activated carbon and/or another adsorbent upstream of a bag filter (described in Section 2.12.5.2.3). The Hg content in the input material as well as the cycles of the operation may result in higher or lower variations in the emission.

Achieved environmental benefits

Reduction of Hg emissions.

Environmental performance and operational data

Mercury removal systems employed prior to a sulphuric acid plant aim to reduce the mercury content in the off-gases in order to ensure the production of good quality sulphuric acid. However, Hg removal systems can also be applied to reduce emissions of mercury before the stack.

The product specification is normally < 0.1 ppm to 0.5 ppm in sulphuric acid and is equivalent to < 0.02 mg/Nm³ in the cleaned gas. The aims are for the reduction of emissions and recovery of mercury, and the production of mercury-free sulphuric acid. In compliance with Regulation (EC) No 1102/2008, metallic mercury gained from non-ferrous mining, smelting operations and extracted from cinnabar ore in the European Union shall be considered as waste as from 15 March 2011.

Table 2.21 shows the mercury removal techniques applied at Boliden's Rönnskär copper, lead and zinc smelter and its performance.

Table 2.21: Performance of the Hg removal techniques applied at Boliden Rönnskär

Technique	Flow (Nm ³ /h)	Load	Before (µg/Nm ³)	After (µg/Nm ³)	Separation efficiency %
Chloride/Boliden-Norzink process	30 000	Maximum	9879	30	99.7
		Minimum	51	13	74
Dowa filter	170 000	Maximum	50	1.4	97
		Minimum	10.5	1.2	88
Selenium filter	80 000	Maximum	1008	48	95
		Minimum	42	12	71
Activated carbon filter	80 000	Maximum	1206	32	97
		Minimum	37.2	2.7	93

Source: [379, Sweden 2013]

Emissions of mercury associated to those non-ferrous metal plants that do not include sulphuric acid production are reported in the metal-specific chapters and range between 0.02 mg/Nm³ and 0.05 mg/Nm³. Figure 2.31 gives an overview of the performance of the techniques applied in order to reduce the mercury emissions to air [378, Industrial NGOs 2012].

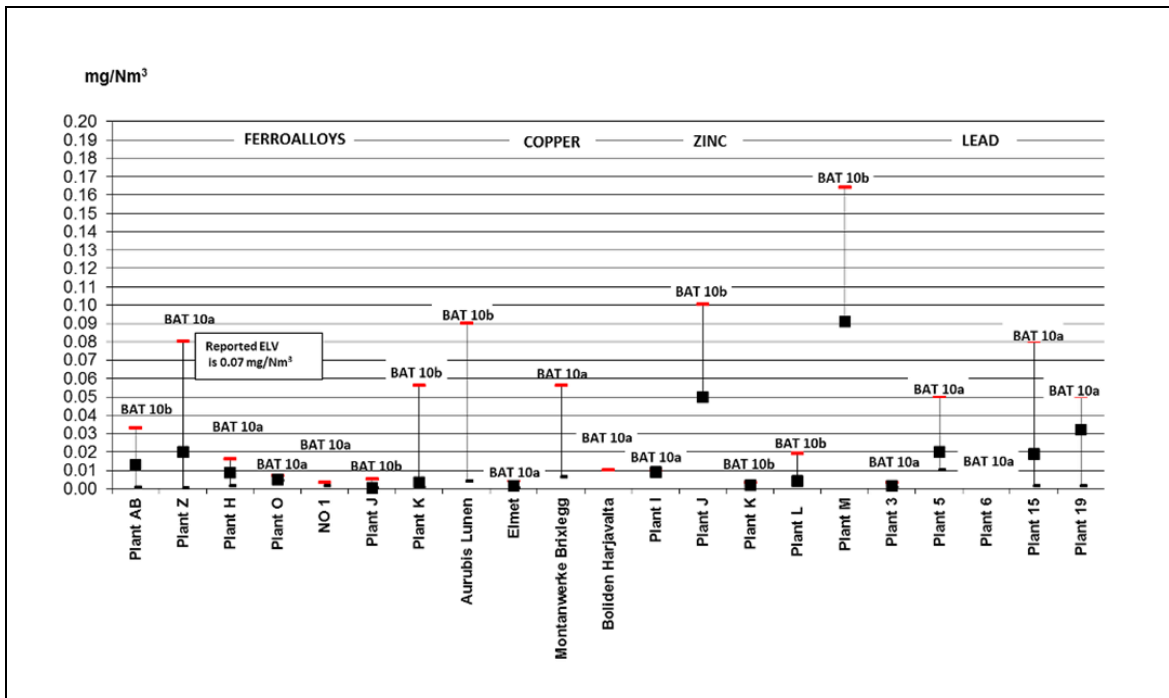

Figure 2.31: Mercury emissions to air from different non-ferrous metals production processes

Cross-media effects

- Increase in energy use.
- A solid or liquid waste is produced that will require disposal.

Technical considerations relevant to applicability

Applicable to pyrometallurgical processes using raw materials with Hg content.

Economics

The processes are known to be operating economically and costs, where they are available, are reported in Annex 13.3 of this document.

Driving force for implementation

Reduction of emissions.

Example plants

Plants in DE, AT, FR, BE and PL.

Reference literature

[226, Nordic Report 2008] [25, OSPARCOM 1996] [136, Fugleberg, S. 1999], [218, VDI 2002] [292, Kojo et al. 2006] [103, COM 1998], [378, Industrial NGOs 2012] [226, Nordic Report 2008]

2.12.6 Water and waste water management

2.12.6.1 Process-integrated measures

Description

Techniques and methods for the reuse of water are already successfully used in the non-ferrous metal industry to minimise the amount of liquid effluent discharged as waste water. The reduction of waste water is sometimes also economically viable since, as the amount of discharged waste water is reduced, the amount of fresh water that should be taken from the aquatic environment is also reduced. This also has a beneficial effect on the cross-media issues.

Technical description

Table 2.22 and Table 2.23 show the process steps from which the liquid effluents are already extensively recycled and reused.

Table 2.22: Overview of waste water streams and the treatment and minimisation techniques

Source of waste water	Associated process	Minimisation methods	Treatment methods
Process water	Alumina production. Lead-acid battery breaking. Pickling	Return to process as far as possible	Neutralisation and precipitation. Electrolysis
Indirect cooling water	Furnace cooling for most metals. Electrolyte cooling for Zn	Use of sealed cooling system. System monitoring to detect leaks	Use of additives with a lower potential impact on the environment
Direct cooling water	Cu, Al and Pb castings. Carbon electrodes. Ferro-alloys. Chromium metal	Settlement or other treatment. Closed cooling system	Settlement. Precipitation if needed
Slag granulation	Cu, Ni, Pb, precious metals, ferro-alloys	Reuse in a sealed system	Settlement. Precipitation if needed
Electrolysis	Cu, Ni, Zn, Mg	Sealed system. Electrowinning of electrolyte bleed	Neutralisation and precipitation
Hydrometallurgy (blowdown)	Zn, Cd	Sealed system. Blowdown treatment	Settlement. Precipitation if needed
Abatement system (blowdown)	Wet scrubbers. Wet ESPs and scrubbers for acid plants	Blowdown treatment. Reuse of weak acid streams if possible	Settlement. Precipitation if needed
Surface water	All	Cleaning yards and roadways. Good raw materials storage	Settlement. Precipitation if needed. Filtration

Table 2.23: Examples of recycling and reuse

Recycling and/or reuse of effluents in the non-ferrous metals industries						
Source	Production process					
	Primary copper	Secondary copper	Primary lead	Secondary lead	Primary zinc	Ferro-alloys
Slag granulation	■	■	■	NA	■	■
Wet air pollution control	■	■	■	■	■	■
Roasting gas washing effluent	■	NA	■	NA	■	NA
Cooling water	■	■	■	■	■	■
Anode and cathode rinse water	■	■	NA	NA	■	NA
Spent electrolyte	■	■	NA	NA	■	NA
Battery breaking	NA	NA	NA	■	NA	NA
Battery classification	NA	NA	NA	■	NA	NA
Lead paste desulphurisation	NA	NA	NA	■	NA	NA

NB: NA = Not applicable.

Recycling and reuse techniques are process-integrated measures. Recycling involves the recirculation of the liquid to the process where it was generated. Reuse of an effluent means the

recirculation of one source of water for another purpose, e.g. surface run-off water may be reused as cooling water.

Normally a recycling system needs a basic treatment technique, or blowdown of approximately 10 % of the circulating liquid, to prevent a build-up of suspended solids, metals and salts in the recirculation system. For instance, cooling water is normally recycled and flows in a recirculation system, as shown in Figure 2.32 below. The use of biocides should also be taken into account.

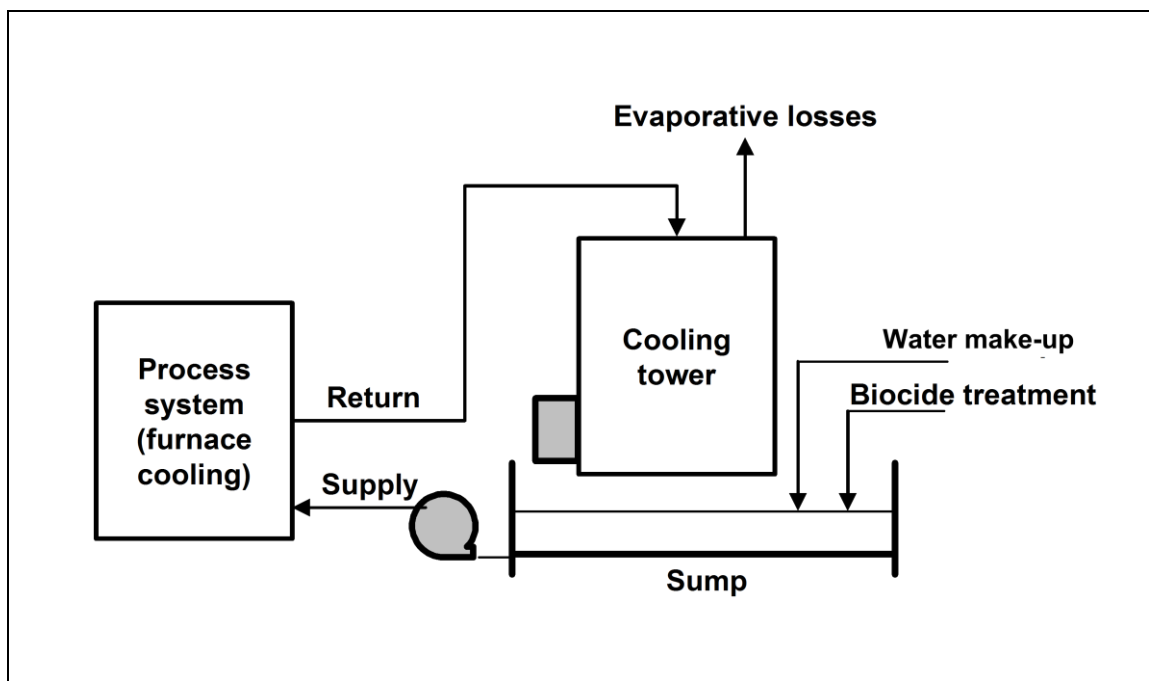

Figure 2.32: Example of a cooling water recirculation system

After treatment, the purified water can also be reused for cooling, sprinkling and certain processes. The salt content of the purified water can pose problems for reuse, e.g. calcium precipitation in heat exchangers. And attention should be paid to the risk of legionella growth in warm water. This can considerably limit the reuse of water.

If large quantities of water are available, for example in a coastal site, a flowing cooling water system can be used, provided the environmental impact is negligible. Nevertheless, effects to the marine environment in the suction area of the flowing cooling water system should be considered. The case for this approach should be made on a site-by-site basis, as the energy costs of pumping and cooling systems should be balanced.

The amount of water discharged is therefore an issue as some installations use extensive water recirculation systems. One copper smelter reported that a daily discharge volume of 3000 m³/d, while similar plants that do not recirculate to the same extent discharge more than 100 000 m³/d. The mass emissions of pollutants are therefore the factor that should be used when assessing the impact of discharges. [238, ECI 2012].

Achieved environmental benefits

Prevention of the generation of waste water.

Environmental performance and operational data

None reported.

Cross-media effects

- Use of energy.
- Use of additives, e.g. precipitation chemicals or biocides, for cooling water make-up.
- Noise, e.g. arising from cooling towers.
- Transfer of heat from water to air.
- Possible propagation of legionella in closed systems at temperatures between 25 °C and 60 °C.

Technical considerations relevant to applicability

Water recycling or reuse could be limited by the solution conductivity.

Economics

No information provided.

Driving force for implementation

Prevention of the generation of waste water.

Example plants

Information can be found in the metal-specific chapters.

Reference literature

[238, ECI 2012]

2.12.6.2 Waste water treatment techniques

Any non-recyclable or non-reusable water has to be treated in order to minimise the concentration of pollutants such as metals, acidic substances and solid particles in the final effluents discharged to the aquatic environment. To reduce the concentration of water pollutants, end-of-pipe techniques, e.g. chemical precipitation, sedimentation or flotation and filtration, may be used. These techniques are normally used together in a final or central on-site waste water treatment plant, but opportunities can also be taken to precipitate metals before the process stream is mixed with other effluents.

The most appropriate treatment technique or combination of different treatment methods can only be chosen on a site-by-site basis by taking into account the site-specific factors. The most important factors to decide the best way to minimise the amount of waste water and the concentration of the pollutants are:

- the process that generates the waste water;
- the amount of water;
- the pollutants and their concentrations;
- the possibilities for internal reuse;
- the availability of water resources.

Table 2.24 presents the advantages and disadvantages of the most common treatment techniques.

Since these techniques are widely applied within the sector, general information about these techniques (such as 'Description' and 'Technical description') can be found in this section. Metal-specific information (such as 'Environmental performance and operational data' and 'Example plants') can be found in the metal-specific chapters.

Table 2.24: Summary of advantages and disadvantages of common waste water treatment techniques

Treatment technique	Advantages	Disadvantages
Precipitation	<p>Cheap and simple technique Long history of successful use Does not require large expenditure in a new plant Capable of treating a wide range of metal contaminants particularly if two-stage precipitation with hydroxide and then sulphide reagents is used Under the correct conditions, can give excellent removal of metals Specified precipitants are commercially available Allows absorptive precipitation Precipitates can often be returned to the feed</p>	<p>Acid effluents can be difficult to treat Non-selective: gives a high water content sludge that contains a cocktail of toxic and non-toxic metals The sludge may have to be disposed of, sometimes at great cost The presence of other salts, organic complexing agents and solvents can severely compromise the precipitation efficiency Cannot always be used to treat low concentrations of metals Some hydroxides inefficiently precipitated</p>
Sedimentation	<p>Cheap and simple technique Long history of successful use</p>	<p>Can only remove solid particles For particles with a small density difference to water, sedimentation takes a long time and large basins are required</p>
Filtration	<p>Cheap and simple technique Long history of successful use Filtration (e.g. sand filter) is best used for a known solid matter</p>	<p>Can only remove solid particles The filtration efficiency decreases if the particles are very small Filtration efficiency decreases with increased velocity</p>
Flotation	<p>Cheap and simple technique Long history of successful use</p>	<p>Can only remove solid particle complexes that are floatable Air needs first to be dissolved in pressurised water to be dispersed</p>
Ultrafiltration	<p>Simple technique Very fine particles, even molecules, can be removed from the waste water Very fine membranes will also filter solutes as small as metals Virtually zero solids emissions</p>	<p>Limited flow rate and filtration velocity Membranes can quickly decompose in corrosive effluents No separation of metals Old membranes can leak Membranes can be easily fouled</p>
Electrolysis	<p>Can be used to recover and recycle metals Can be used to treat concentrated metal effluents (about 2 g/l) in a single step Technology mostly available Tried and tested with good track record in electroplating industries Can be used to clean up organic contaminants simultaneously Can be used in batch or continuous flow modes</p>	<p>Better than ppm level of clean-up is difficult Ineffective cells are expensive to maintain and operate Electrolysis not selective Needs constant monitoring Poor at treating variable content, high-volume effluents</p>
Electrodialysis	<p>Can be used to recover and recycle metals Can be selective Already used in desalination and electroplating industries Capable of sub-ppm level of clean-up</p>	<p>Suffers from the same disadvantages as ion exchange methods (e.g. membrane fouling) Needs constant monitoring Poor at treating variable content, high-volume effluents</p>

Reverse osmosis	<p>Virtually zero emissions Technology exists and equipment is commercially available Can be used for recycling metals Can be operated in continuous flow or batch mode Can deal with a large range of metal concentrations Can be used to remove organics in effluent Efficacy is not strongly dependent on the concentration of non-corrosive contaminants in effluent</p>	<p>Limited flow rate and filtration velocity Membranes can quickly decompose in corrosive effluents No separation of metals Old membranes can leak Membranes can be easily fouled Membranes need frequent monitoring and replacement Equipment is specialised and expensive Uses high pressure Restriction of a minimum flow rate of approximately 200 l/min Concentrated bleed is produced that needs further treatment</p>
Ion exchange	<p>Relatively inexpensive Commercial products available Tried and tested in industrial applications (e.g. rhenium and selenium removal and recovery) Capable of clean-up to ppb level (selective ion exchange capable of ppt level) Can be easily used in conjunction with other techniques (e.g. precipitation) as part of an integrated waste water treatment Can be selective for metals Can be applied to many flow types: intermittent, continuous, relatively large volume Selective ion exchange has been used in isolated cases, such as the treatment of nuclear industry effluents</p>	<p>Cannot handle large concentrations of metal Matrix easily fouled by solids and some organics Traditional ion exchange is not selective Exhausted exchanger must usually be disposed of as toxic waste Matrices can decompose over time Performance is sensitive to effluent pH Large-volume effluents require very large ion exchange columns Selective ion exchange has not been extensively used on an industrial scale to date Regeneration of selective ion exchange columns is time-consuming Long contact times with effluent may be needed</p>
Activated carbon	<p>Can be used for a wide range of applications (e.g. the removal of mercury or PCDD/F from effluent) Can be added after coagulation and sedimentation as a layer in sand filters Technology exists and equipment is commercially available</p>	<p>Activated carbon is expensive Activated carbon can become a breeding ground for microorganisms High emissions of SO₂ generated from the heating process in manufacturing carbon from coal</p>

2.12.6.2.1 Chemical precipitation

Description

This consists of adding a reagent such as lime, sodium hydroxide or sodium sulphide or a combination of reagents, to adjust the pH value and promote the precipitation of soluble metals.

Technical description

Chemical precipitation is used primarily to remove the soluble metal ions from the liquid effluent. The soluble metals can be precipitated from the waste water by the adjustment of the pH value. A reagent, such as lime, sodium hydroxide or sodium sulphide, or a combination of reagents is added to the effluent and forms an insoluble compound with the metal in the form of a precipitate. These insoluble compounds can then be removed from the water by filtration and sedimentation. The addition of a coagulant or flocculant helps to form larger flocs, which can be separated more easily, and is often used to improve the performance of the system. At least one plant uses a biological process to generate hydrogen sulphide to precipitate the metals as the sulphide.

Precipitation is usually used to remove metals from a waste water stream, such as in the removal of iron, lead, zinc, chromium, manganese, etc. The hydroxides of metals are usually insoluble, so lime is commonly used for precipitating them.

Similarly, metal sulphides are also insoluble and reagents such as sodium sulphide, sodium hydrogen sulphide and trimercapto-sulpho-triazine (TMS) are used in alkaline conditions. H_2S can also be produced biologically using a sulphate-reducing bacteria and the gas is transported to the precipitation stage with a carrier gas. Sulphide precipitation can result in much lower concentrations in the cleaned effluent for certain metals, depending on the pH and temperature, and the metal sulphide produced can be returned to the smelting stage. Metals such as selenium and molybdenum can also be effectively removed.

Zinc sulphate solutions are treated in a biological conversion stage using hydrogen as an electron donor, which is produced by converting natural gas and steam. Zinc sulphide is produced at a rate of 10 tonnes per day and is recycled back to the smelter.

In some cases, the precipitation of a mixture of metals can be carried out in two stages; firstly with hydroxide, followed by a sulphide precipitation. Ferric sulphate can be added after precipitation to remove the excess sulphide.

In order to maximise the efficiency of metal removal, the process should be treated at different pH values with different reactants. The choice of reactant and the pH value are the main considerations for the precipitation of metals. Solubility is also affected by temperature and this should be taken into account.

Another important factor is the valence state of the metal in the water. For example, for chromium, the hexavalent form, chromate, is considerably more soluble than the trivalent form. In this case, chromate must be reduced, usually with SO_2 at a low pH, for the removal of chromium by a precipitation process.

Pentavalent arsenic, As (V), is reduced to As (III) by the reaction with sulphide ions although some As_2S_5 may be formed. The reduction of As (V) is temperature-dependent and rather slow, at least below 50–60°C. Trivalent arsenic, As (III), is precipitated as As_2S_3 with sulphide below pH 4–5. Precipitated As_2S_3 must be separated from the water at pHs below 4–5. If the pH is raised and As_2S_3 is present, there is a risk that the arsenic returns to the solution.

In the non-ferrous metals industry, trace metals can be effectively removed from effluents by the addition of ferric salts. Arsenic is removed as either calcium or ferric arsenate by precipitation. Arsenites can also be precipitated, but they are generally more soluble and less stable than arsenates. Effluent that contains arsenite is generally oxidised prior to precipitation

to ensure that the arsenate predominates. Process water from the processing of arsenic-bearing raw materials may contain varying amounts of As (III) and (V) oxyanions, arsenites and arsenate. The presence of such metal ions as copper, lead, nickel and zinc limit the solubility of arsenic because of the formation of sparingly soluble metal arsenates [295, European Commission 2004]. [295, Gaver C. Jr 2013]

The stability and solubility of these arsenates depends on the ratio of iron to arsenic. The larger the ratio, the more insoluble and stable the precipitate. While ferric arsenate is relatively soluble, the basic arsenates with an iron to arsenic molar ratio of eight or more are an order of magnitude less soluble in the pH range 2 to 8.

The precipitation of insoluble ferric arsenates is accompanied by the co-precipitation of other metals, such as selenium, that involves interactions between the various metals species and the ferric hydroxide precipitate. This makes ferric salts a very effective scavenger for the removal of trace contaminants. Arsenic is precipitated as Fe-As compounds by adding ferric sulphate ($\text{Fe}_2(\text{SO}_4)_3$). If the pH is 6 or lower, arsenic can be precipitated completely. It is difficult to precipitate nickel and arsenic at the same time, hence a two-stage treatment is required.

The pH dependency of As precipitation compared to the optimum conditions for the precipitation of other metals (Ni, Cu, etc.) means that different optimum pH values exist and minimum values of each metal are not possible with one process.

The final aspect is the possible formation of complex ions, which are generally more soluble. This is common when dealing with waste water that contains ammonia, chloride, fluoride or cyanides along with the metals.

In many plants where metals are removed, one of the principal problems in reaching the desired effluent limits is the colloidal state of the precipitated materials. This can result from improper neutralisation and flocculation. Various flocculants or coagulants can be used to improve the condition of the precipitated material and suppliers of these materials are able to test the precipitates and specify the correct coagulant.

The efficiency of waste water cleaning using chemical precipitation is mainly influenced by the following factors:

- the choice of chemical precipitant;
- the amount of precipitant added;
- the efficiency of removal of the precipitated metal;
- the maintenance of the correct pH throughout the treatment process;
- the use of iron salts to remove specific metals;
- the use of flocculating or coagulating reagents;
- the variation of waste water composition;
- the presence of complex-forming ions.

To ensure the maximum removal efficiency of metals, the most important factor is the choice of precipitants. Some experiences show that the use of sulphide-based reagents can achieve lower concentrations of some metals. Correct pH throughout the effluent treatment process is also of primary importance, as some of the metal salts are insoluble only over a very short range of pH values. Outside these ranges, the efficiency of metal removal decreases rapidly, for example zinc will form a soluble anion, zincate, at high pH values.

Effluent water composition changes depending on concentrate/raw material quality and the composition of the subsequent off-gases that have been cleaned in wet systems. Additionally, the batch-wise feed of different sources or weather conditions for run-off water increases the variety of effluent waste water. Often, adaptation of process parameters is required for optimised performance.

Achieved environmental benefits

Reduction of emissions to water.

Environmental performance and operational data

Performance data for a combination of the techniques listed in Section 2.12.6.2 are given in the metal-specific chapters.

The techniques to be applied have to take into consideration the specificity of the production processes. Also, the size and the flow rate of the water body can play a role in the choice of the techniques to be applied. Reducing the volume flow in favour of higher concentrations needs less energy for the treatment. Treating highly concentrated waste waters will result in higher effluent concentrations but with a better reduction rate than lower concentrated flows, giving an improved overall removal of pollutants.

Cross-media effects

- Use of energy.
- Use of additives.
- Production of waste for disposal.

Technical considerations relevant to applicability

Generally applicable.

Economics

No information provided.

Driving force for implementation

Reduction of emissions to water.

Example plants

Information can be found in the metal-specific chapters.

Reference literature

[11, Hatch Associates Ltd 1993], [146, Kemmer 1988], [168, Steil, H.U. et al. 1999], [234, UBA (D) 2007], [240, Nyrstar Budel 2008], [319, Boonstra 2003], [320, Huisman 2004], [321, Weijma 2007], [295, Gaver C. Jr 2013], [238, ECI 2012]

2.12.6.2.2 Treatment of weak acid and process water

Description

Treatment of waste water comprising weak acid from the sulphuric acid plant or various acidic washing waters using lime and iron sulphate.

Technical description

The process outline is shown in Figure 2.33.

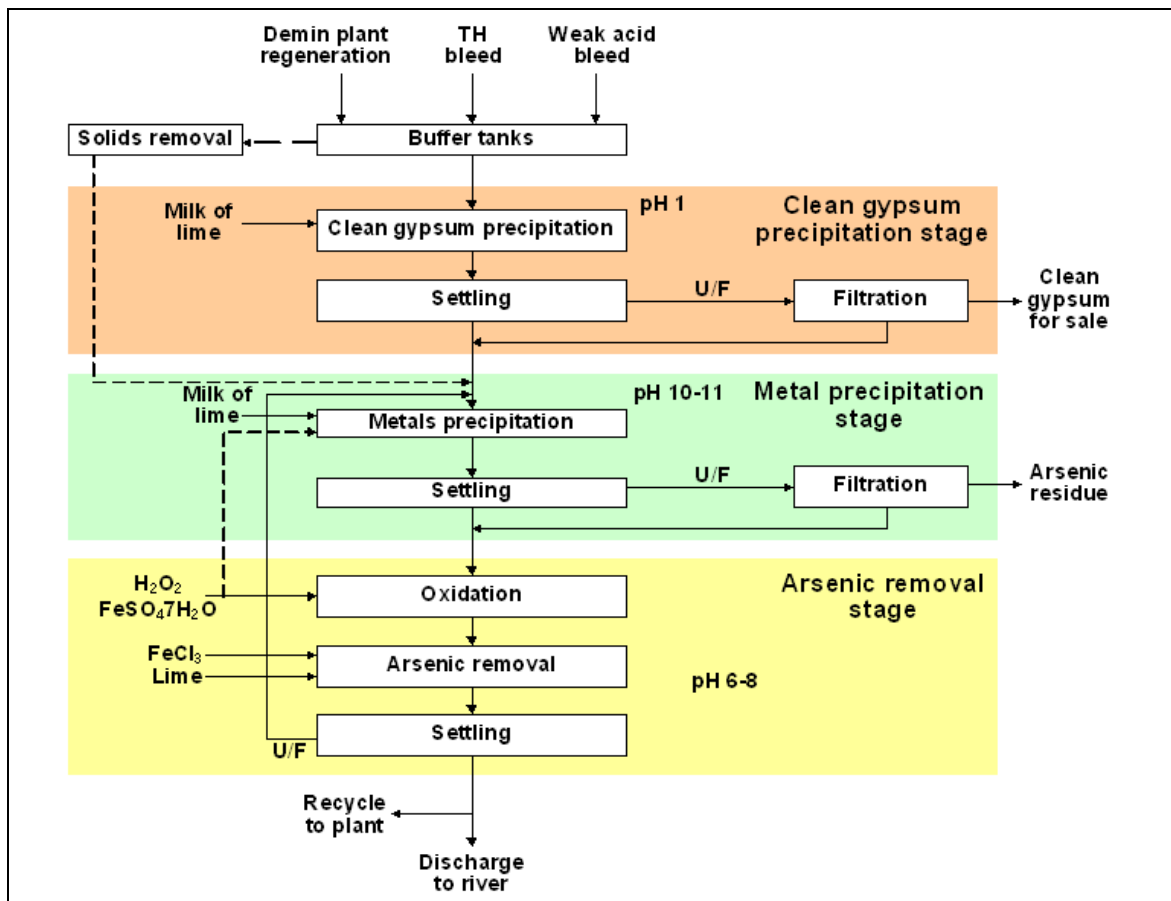

Figure 2.33: Treatment of weak acid

Achieved environmental benefits

- Minimum waste water discharge.
- Reduction in emissions to water and water consumption.
- Production of clean gypsum.

Environmental performance and operational data

The results achieved are given in Table 2.25.

Table 2.25: Performance data for the treatment of weak acid

Parameter	Range	Unit
Inlet conditions		
Flow	35	m ³ /h
Content:		
H ₂ SO ₄	60	g/l
Cu	2100	mg/l
Hg	15	mg/l
As	2200	mg/l
Pb	2600	mg/l
Ni	7	mg/l
Cd	110	mg/l
Suspended solids	200	mg/l
Effluent water (¹)		
Flow	31.2	m ³ /h
pH	9.5	
Cu	0.1–0.5	mg/l
Hg	0.05	mg/l
As	0.05–0.2	mg/l
Pb	0.1–0.5	mg/l
Ni	0.1–0.5	mg/l
Cd	0.01–0.2	mg/l
Gypsum sludge		
	6–7	t/h
	40–50	% moisture
	~ 30–35	% CaSO ₄
	~ 1	% As
Amount	~ 1	% Cu
Composition	~ 1–2	% Fe
	~ 0.01	% Hg
	~ 1	% Pb
	~ < 0.1	% Ni
	~ < 0.1	% Cd
⁽¹⁾ Design data taking variations in effluent into account. NB: The metal concentrations are daily averages based on qualified random samples or 24-hour flow-proportional samples. Source: [238, ECI 2012]		

The gypsum that is produced contains > 96 % Ca SO₄·2H₂O.

Cross-media effects

No cross media effects were reported.

Technical considerations relevant to applicability

Generally applicable.

Economics

Equipment costs were EUR 2.5 million, installation costs were EUR 4.5 to 5.2 million.

Electricity: 200 kWh. Lime milk (10 %); 15 m³/h. H₂SO₄ (10 %); 0.8 m³/h. FeSO₄·7H₂O; 80 kg/h.

Driving force for implementation

Effective treatment of weak acid to produce a saleable product.

Example plants

Plants in Spain and Bulgaria.

Reference literature

[238, ECI 2012]

2.12.6.2.3 Biological treatment**Description**

See below.

Technical description

One plant uses a biological process to produce sulphide ions. Weak acid which is the bleed from the wet gas cleaning has a high sulphate concentration (10–25 mg/l). The sulphate is reduced to sulphide ions with hydrogen gas and sulphate-reducing bacteria in a biological waste water treatment plant:

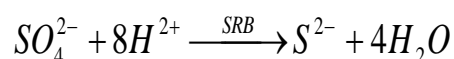

The hydrogen is produced from natural gas and steam in a reformer unit. The zinc and other metals react with S^{2-} and precipitate as a metal sulphide:

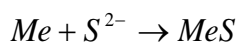

Sulphate and metal concentrations after this treatment are still too high to be discharged directly and the water is treated in another step together with other waste water from production and groundwater. This also uses sulphate-reducing bacteria to precipitate metals with sulphide, but in this case ethanol is used as the electron donor instead of hydrogen [240, Nyrstar Budel 2008]

The metal sulphides and biomass slurry is reused as concentrate in the roasting stage.

Achieved environmental benefits

Reduction of emissions to water.

Environmental performance and operational data

Performance data for this technique is given in Section 6.3.4.

The metal contents of the effluent of such a biological process are similar to those of the cleaned water of the best-performing waste water treatment based on inorganic sulphide addition (NaHS, Na_2S), mainly as the chemistry behind both processes is fundamentally the same (based on the low solubility of metal sulphides). The biological process has a positive effect because the sulphate content of the treated water is reduced.

Cross-media effects

No information provided.

Technical considerations relevant to applicability

The technique is applicable to weak acid where there are no other recovery options and for waste waters from the RLE process in admixture with contaminated groundwater.

Economics

Compared to inorganic sulphide addition, there are the significantly higher investment and operational costs, but one plant is known to be operating viably.

Driving force for implementation

Clean-up of historical environmental problems.

Example plants

A plant in the Netherlands.

Reference literature

[319, Boonstra 2003], [320, Huisman 2004], [240, Nyrstar Budel 2008]

2.12.6.2.4 Sedimentation and flotation

Description

Sedimentation is a solid-liquid separation technique that utilises gravity to separate the insoluble metal complexes and solid particles from the liquid effluent.

Flotation techniques are used to separate large flocs or floating particles like plastic parts from the effluent by bringing them to the surface of the suspension.

Technical description

Sedimentation can take place in a variety of different settling vessels like sedimentation basins, lagoons or specialised sedimentation tanks (thickeners, clarifiers) with a sludge removal device at the bottom of the tank. Sedimentation basins, which are commonly used, are rectangular, square or circular. The sludge that is removed from the sedimentation step can be dewatered, e.g. using a vacuum filter press. The filtrate that is generated may be sent back to the beginning of the effluent treatment process or to the process step where it was generated, depending on the treatment process. Sedimentation can be used to separate solid particles from waste water that has been used for the granulation of slag or the production of metal shot.

An alternative to sedimentation may be flotation. Flotation can be achieved by dissolved air flotation. Air is dissolved in the suspending medium under pressure and leaves the solution when the pressure is released as minute air bubbles attached to suspended particles. This causes the particles to float to the surface and the flocs can then easily be removed from the surface of the liquid.

Achieved environmental benefits

Reduction of emissions to water.

Environmental performance and operational data

Performance data for a combination of the techniques listed in Section 2.12.6.2 are given in the metal-specific chapters.

Cross-media effects

None reported.

Technical considerations relevant to applicability

Generally applicable.

Economics

No information provided.

Driving force for implementation

Reduction of emissions to water.

Example plants

Information can be found in the metal-specific chapters.

Reference literature

No information provided.

2.12.6.2.5 Filtration

Description

Filtration is the separation of solids from waste water effluent passing through a permeable medium. Sand is the most commonly used filtering medium.

Technical description

Filtration techniques are normally used for solid-liquid separation and as a final clarification step in a waste water treatment process. The filtration unit is usually located between the sedimentation step and the final control, to remove solids carried over from the previous cleaning step. Filtration can take place in a variety of different filter systems, depending on the solid particles that have to be removed.

The normal filter unit consists of a bed of material or materials through which the liquid effluent flows. The fine particles that cannot pass through the filter medium form a filter cake that should be removed either continuously or from time to time, for example by backwashing, in order to keep the pressure loss low. If the pressure loss is low, it enables the filtration to be fed with the waste water flow via a gravity flow.

Sand filters are designed for the mechanical removal of suspended solids or semi-solid materials, e.g. sediments or metal hydroxides. The purification of waste water using sand filtration is due to the combined effects of filtration, chemical sorption and assimilation. Sand filters are sometimes operated as a pressure vessel filled with layered sand, which increases in grade with depth. Initially the filter cake can lead to an enhancement of the filtration efficiency, particularly for smaller particles. After a period of time, the sand bed should be backwashed. Sand filters are often used for polishing a bleed from a closed water cycle or to allow the effluent to be used as process water. A typical sand filter is shown in Figure 2.34.

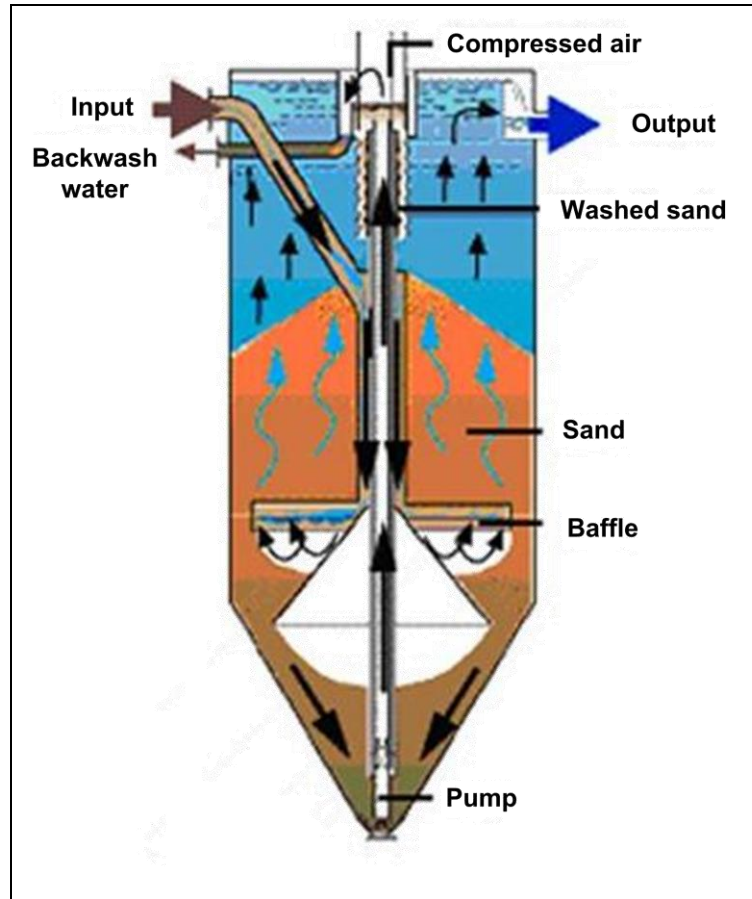

Figure 2.34: Schematic of a sand filter

Hyperfiltration or reverse osmosis is used to obtain the desired result for very fine particles. Hyperfiltration allows the passage of particles with a molecular mass of about 100 u to 500 u, whereas ultrafiltration is used in the range of 500 u up to 100 000 u.

Ultrafiltration is a simple and effective method of waste water treatment but has a high energy requirement. The effluent is placed in contact with an ultrafiltration membrane. This membrane, which contains small pores, allows the passage of molecular particles like water and hinders larger molecular particles. With a very fine membrane it is even possible to filter solutes as small as metal ions. Filtration processes based on membranes produce a clean permeate and a concentrate that may require further treatment.

Achieved environmental benefits

Reduction of emissions to water.

Environmental performance and operational data

Performance data for a combination of the techniques listed in Section 2.12.6.2 are given in the metal-specific chapters.

Cross-media effects

None reported.

Technical considerations relevant to applicability

Generally applicable.

Economics

No information provided.

Driving force for implementation

Reduction of emissions to water.

Example plants

Information can be found in the metal-specific chapters.

Reference literature

[374, COM 2001]

2.12.6.2.6 Electrolysis

Description

Passage of a direct electric current through an ionic substance resulting in a chemical reaction at the electrodes. The ionic substance is either molten or dissolved in a suitable solvent.

Technical description

Electrolytic techniques are used to remove metals such as copper, precious metals, chromium, manganese, cadmium, etc. from process water streams. Because the metal concentrations are usually low, electrolysis is most effective for waste streams before they are diluted with other effluents. Special electrodes such as fluidised bed electrodes or three-dimensional electrodes can be used to improve efficiency. The maximum efficiency of the cell is achieved when the current density changes with the solute concentration and the mass transfer takes place close to the limiting current density. In other words, the cathode must always have a fresh supply of ions to reduce.

An alternative, and very successful, use of electrochemical methods for metal clean-up is to oxidise metals in effluents so that they can be recycled. One example is the treatment of effluents that contain chromium(III). The largest use of chromium is as an oxidising agent where chromium is in its (VI) oxidation state. The by-product from the oxidation is

chromium(III), which is normally released with waste. Anodic oxidation of chromium(III) effluent has been used to regenerate chromium(VI), which can be reused.

The difference in the relative position in the electrochemical series or the redox potential of the elements can also be exploited by controlling the current and voltage of an electrolytic cell to recover the more noble metals. These properties can also be exploited by using cementation, where, for example, copper can be precipitated by adding iron.

Another electrochemical treatment method is electrodialysis. The electrodialysis cell consists of two electrodes separated by an ion exchange membrane. The theory is fairly straightforward. Cations under the influence of an electrode potential migrate through a cationic exchange membrane where they are exchanged for less toxic cations (for example exchanging cadmium for sodium). This method aims to combine the advantages of ion exchange with the advantages of electrochemical treatment. [145, Dalrymple, I. 1999], [166, Clark, J.H. 1995].

Achieved environmental benefits

Reduction of emissions to water.

Environmental performance and operational data

Performance data for a combination of the techniques listed in Section 2.12.6.2 are given in the metal-specific chapters.

Cross-media effects

None reported.

Technical considerations relevant to applicability

Generally applicable.

Economics

No information provided.

Driving force for implementation

Reduction of emissions to water.

Example plants

Information can be found in the metal-specific chapters.

Reference literature

[145, Dalrymple, I. 1999], [166, Clark, J.H. 1995].

2.12.6.2.7 Reverse osmosis

Description

A membrane process in which a pressure difference applied between the compartments separated by the membrane causes water to flow from the stronger solution to the weaker.

Technical description

Reverse osmosis is extensively used for the removal of dissolved metals, especially in the electroplating industry. Osmosis is the natural diffusion of a solvent, such as water, caused by a difference in the concentration of two solutions separated by a membrane. The solvent flows in the direction that will reduce the concentration of the stronger solution. In reverse osmosis, a force is applied to reverse the solvent flow. The pressure required must exceed the osmotic pressure. Typical data for the passage of ions across a reverse osmosis membrane are presented in Table 2.26. Reverse osmosis is sometimes used for the recovery of precious metals in the metal plating industry.

Table 2.26: Typical passage of ions across a reverse osmosis membrane

Ions	Passage (%)	Rejection (%)
Ammonium	8	92
Sodium	5	95
Potassium	5	95
Magnesium	3	97
Strontium	3	97
Calcium	2	98
Nitrate	15	85
Bisilicate	10	90
Chloride	5	95
Fluoride	5	95
Bicarbonate	5	95
Sulphate	3	97
Phosphate	1	99
<i>Source: [146, Kemmer 1988]</i>		

Achieved environmental benefits

Reduction of emissions to water.

Environmental performance and operational data

Performance data for a combination of the techniques listed in Section 2.12.6.2 are given in the metal-specific chapters.

Cross-media effects

None reported.

Technical considerations relevant to applicability

Only applicable to specific streams in NFM production.

Economics

No information provided.

Driving force for implementation

Reduction of emissions to water.

Example plants

Information can be found in the metal-specific chapters.

Reference literature

[146, Kemmer 1988]

2.12.6.2.8 Ion exchange**Description**

The ion exchange process normally takes place in a column that is packed with beads of ion exchange resin. The exchange starts first at the top of the column and then passes through the column in order to keep the exchange conditions stable.

Technical description

Ion exchange is sometimes used as a final cleaning step in the removal of metals from process waste water. By using an ion exchange, unwanted metal ions can be removed from a waste water stream by transferring them to a solid matrix while giving back an equivalent number of

other ions stored on the ion exchanger skeleton. The ion exchange process is usually used for metal concentrations below 500 mg/l.

Depending on the amount of ions stored on the skeleton, the capacity of the ion exchanger is limited. The ion exchanger should therefore be regenerated with hydrochloric acid or caustic soda. In some cases, such as the removal of selenium and rhenium from the off-gas of a molybdenite roaster, the ion exchangers are replaced periodically so that the metals can be recovered by the plant itself or by specialised plants.

Some specified ion exchangers are able to remove specific metals from the waste water. This selective ion exchange process is much more efficient in removing toxic metals from the effluent. Furthermore, the column is capable of a very high level of clean-up and is also able to operate efficiently with mixed content effluents.

Achieved environmental benefits

Reduction of emissions to water.

Environmental performance and operational data

Performance data for a combination of the techniques listed in Section 2.12.6.2 are given in the metal-specific chapters.

Cross-media effects

None reported.

Technical considerations relevant to applicability

Generally applicable.

Economics

No information provided.

Driving force for implementation

Reduction of emissions to water.

Example plants

Information can be found in the metal-specific chapters.

Reference literature

No reference literature provided.

2.12.6.2.9 Activated carbon**Description**

This is a filtration process in which activated carbon is used as the filtering medium.

Technical description

Activated carbon, a highly porous carbonaceous substance, is usually used to remove organic materials from waste water, but it also has applications in the removal of mercury and precious metals. These filters are normally used in the form of beds or cartridges operated in multiples, so that the breakthrough from one filter is treated by a second one. The spent filter is then replaced and becomes the downstream filter. This operation depends on an adequate method to detect breakthrough from the filters.

Achieved environmental benefits

Reduction of organic materials, mercury and precious metals emissions to water.

Environmental performance and operational data

Performance data for a combination of the techniques listed in Section 2.12.6.2 are given in the metal-specific chapters.

Cross-media effects

None reported.

Technical considerations relevant to applicability

Generally applicable.

Economics

No information provided.

Driving force for implementation

Reduction of emissions to water.

Example plants

Information can be found in the metal-specific chapters.

Reference literature

[374, COM 2001]

2.12.7 Residues management

Description

Set of techniques to minimise the generation of residues from the metallurgical process.

Technical description

As mentioned in Section 2.9.1, the amount of slag and skimmings/dross that is produced by smelting metals is mainly influenced by the impurities of the raw material, so cleaner materials lead to a reduced generation of these solids. In some cases, this can be ensured by careful selection of the raw material that will be used. For example, some zinc concentrates can contain lower quantities of iron [98, Lijftogt, J.A. et al 1998], and the processes developed to use these concentrates can minimise the production of iron-based residues. The limited availability and higher costs of these concentrates means that this is not a global solution. For secondary aluminium, the pretreatment of scrap or the use of cleaner materials results in the reduction or elimination of the salt flux used, depending on the furnace used. The economics of pretreatment need to be balanced. Where the separation of impurities is effected by the addition of reagents, controlling the addition of reagents to the level required to achieve efficient and economic removal will minimise the amount of residue that is produced.

On the other hand, inappropriate storage and handling may lead to the wetting of materials. For example, in a remelting process for aluminium, the water is vaporised, with the potential for explosions.

The generation of skimmings/dross can be minimised by optimising operation of the furnace, e.g. decreasing the burn-up by avoidance of overheating of the melt. Modern process control techniques are used to ensure optimised operation conditions.

To avoid oxidising the bath surface of a melt, a closed furnace operation could be used. For example, by melting aluminium under a reducing atmosphere (rinsing the furnace with inert gas), the amount of skimmings/dross that is generated is reduced. Similarly, the use of a pumping system and a side well is another measure which can reduce oxidation.

It has been demonstrated that lead ashes and a large amount of the slag that is generated by the smelting process can be recycled or reused to a large extent.

Spent linings and refractories cannot be completely avoided, but a decrease of the quantity can be achieved by the following measures:

- careful construction of the brick lining of the furnace;
- continuous use of the furnace, and thus minimisation of variations in temperature;
- thermal monitoring to detect temperatures outside the operating range;
- cooling blocks to remove heat from the linings;
- short impact time of the fluxing agents;
- avoidance of aggressive fluxing agents;
- careful cleaning of furnaces and crucibles;
- reduction of furnace agitation (rotation);
- choice of the most suitable refractories for the process;
- control of heating/cooling rates where beneficial.

Under certain conditions, depending on the composition of the spent linings and refractories, reuse is possible.

Refractories can be reused in primary and secondary copper smelting after grinding to produce a castable or tapping mass or as a flux to adjust slag composition. Alternatively, the metal content can be separated from the material by milling and grinding and the spent linings and refractories can be reused for construction purposes or to produce refractory linings or refractory cement. The metal content can be recycled to the smelter or supplied to other non-ferrous metal facilities.

In a secondary copper plant, bricks from the shaft furnace, converter and anode furnace can be completely recycled. Converter brick contains up to 1.5 % copper, and the shaft furnace brick contains up to 4 % copper. Bricks are milled and the copper is recovered; the remaining material is used to make refractory cement and refractory linings for the casting wheel. White bricks are reused in the anode furnace and as cement in the shaft furnace and black bricks are used for ladle insulation. Furnace linings are crushed, copper is removed and returned for processing and the refractory parts are reformulated to make moulds for the anode casting wheel [249, Austria, Brixlegg 2007].

Controlling the quality of slag to allow further use is also an important technique to consider. Several slags are relatively inert and can be used as construction materials to replace aggregates, and as abrasives. Good quality control of the material is needed to ensure that it is acceptable for use in construction or elsewhere, and leaching tests are available to demonstrate acceptability, [289, USEPA 2008], [268, Belgium 2008] The Landfill Directive specifies CEN standard leaching tests for granular waste: EN 14405 and EN12457/1-4.

Achieved environmental benefits

- Reduction of the waste sent for disposal.
- Replacement of virgin material with inert slags, to reduce residues or produce refractory cement, etc. and the reuse of material.

Environmental performance and operational data

Several techniques exist to reduce the amount of residues formed in the production processes. Important techniques are to reduce the amount of slag, to recover metals in the slag and to reduce the amount of metals in the residue slag. For example, a ferro-chrome works in Finland has managed to reduce the amount of residue from a ferro-chrome slag extraction process. A machine working with a spiral screw is used to separate chromium from processed fine slag. Chromium is heavier than slag, so it concentrates in the centre of the spiral. The recovered chromium can be reused in the melting shop and the slag is used as a material for new filler products. Filler products are used, for example, in cement and asphalt. This technique has reduced the amount of residue going to disposal by about 10 000 tonnes.

Cross-media effects

None reported.

Technical considerations relevant to applicability

These techniques are applicable to the use of materials that are suitable for the duty envisaged. Spent refractories can be made into lower grade refractory cement or ladle linings and metallurgical slags can be used for construction, provided that they meet leachability standards.

Economics

No information provided.

Driving force for implementation

The costs of disposal.

Example plants

Plants in AT, BE and DE.

Reference literature

[233, COM 2008] [249, Austria, Brixlegg 2007]

2.12.8 Noise and vibration

Noise and vibration are common issues in the sector and the sources are encountered in all sections of the industry. Process noise emitted from an installation into the surrounding environment is a factor that has caused many complaints in the past and some information about causes and approaches to prevent and minimise noise and vibration has been received. The effect of noise on operators within an installation is not within the scope of this document.

The most significant sources of noise and vibration are transport and handling of raw materials and products; production processes involving pyrometallurgy, grinding and milling operations; the use of pumps and fans; the venting of steam; and the existence of unattended alarm systems. Noise and vibration can be measured in a number of ways but generally the detail is site-specific and takes account of the frequency of the sound and the location of population centres.

New plants can be specified with low noise and vibration levels. Good maintenance can prevent equipment such as fans and pumps from becoming unbalanced. The interconnections between equipment can be designed to prevent or minimise the transmission of noise. Common noise abatement techniques are:

- the use of embankments to screen the source of noise;
- the enclosure of noisy plants or components in sound-absorbing structures;
- the use of anti-vibration supports and interconnections for equipment;
- careful orientation of noise-emitting machinery;
- changing the frequency of the sound.

2.12.9 Odour

There are several potential sources of odour in the non-ferrous metals industries. The most significant are metal fumes, organic oils and solvents, sulphides from slag cooling and waste water treatment, chemical reagents used in hydrometallurgical and effluent treatment processes (e.g. ammonia) and acid gases. Odours can be prevented by careful design, choice of reagents and by correct material handling. For example, the generation of ammonia from aluminium skimmings/dross can be prevented by keeping the material dry.

The abatement techniques described earlier in this chapter will all contribute to the prevention or elimination of odours. The general principles of good housekeeping and good maintenance practice also play a major role in prevention and control.

The basic hierarchy of the principles of odour control are:

- to prevent or minimise the use of malodorous materials;
- to contain and extract odorous materials and gases before they are dispersed and diluted;
- to treat them, possibly by afterburning or filtration (see also Sections 2.12.2.2 and 2.12.5.1).

The use of biological media, such as peat or similar material, that act as a substrate for suitable biological species has been successful in removing odours [156, VDI 2008]. The removal of odours can be a very complex and expensive process if strongly odorous materials are diluted. The treatment of very large gas volumes with low concentrations of odorous materials requires a major process plant.

A biofilter is shown in Figure 2.35.

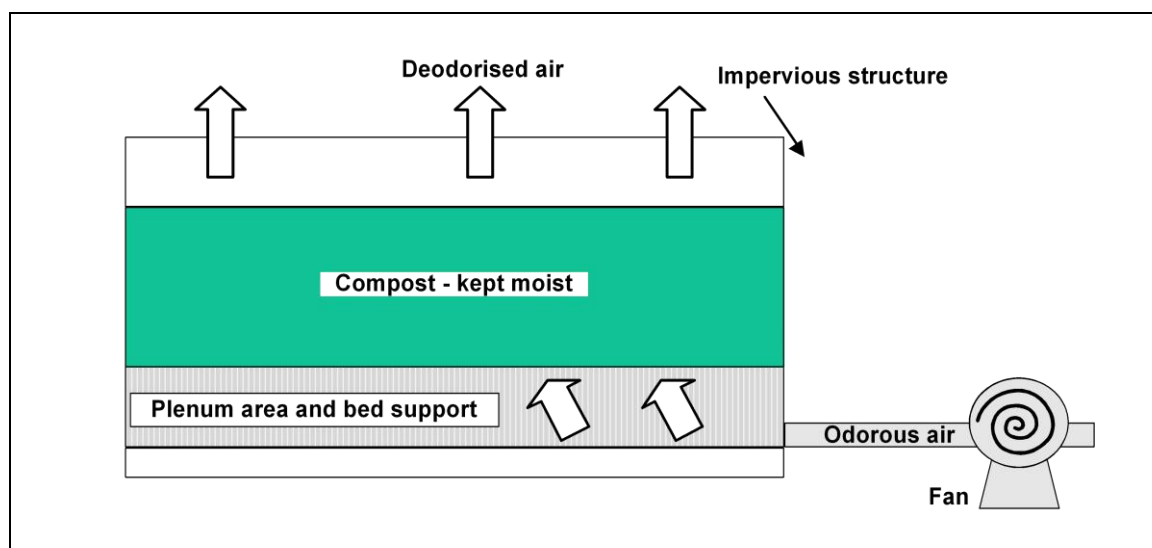

Figure 2.35: Arrangement of a simple biofilter

2.12.10 Decommissioning

Description

See below.

Technical description

This requires assessment of the initial state of a site, before building a new plant, to plan for the end-of-life decommissioning.

This also includes the prevention of chronic risks during the whole life of the plant, to prevent soil pollution, e.g. by developing plans that:

- identify areas that can contribute to diffuse emissions so that action can be taken to prevent windblown dust causing environmental damage or impacts on health in the surrounding areas;
- take action to prevent further contamination of groundwater;
- establish a spill management programme and other soil protection measures;
- extend the containment of other sources that have been identified;

- use an environmental monitoring programme, especially relative to groundwater, during the whole life of the plant, in order to detect would-be impacts outside the plant, in its neighbourhood.

Achieved environmental benefits

Prevention of environmental issues during decommissioning and also of soil pollution.

Environmental performance and operational data

- Considering decommissioning at the design stage minimises risks and excessive costs during later decommissioning.
- For existing installations where potential problems have been identified, a programme of improvements is put in place. These improvement designs need to ensure that:
 - o underground tanks and pipework are avoided where possible (unless protected by secondary containment or a suitable monitoring programme);
 - o there is a provision for the draining and cleaning out of vessels and pipework prior to dismantling;
 - o lagoons and disposal sites are designed with a view to their eventual clean-up or surrender;
 - o insulation is used which can be readily dismantled without dust or hazards arising;
 - o any materials used are recyclable (although bearing in mind that they still need to meet operational or other environmental objectives).
- A site closure plan is developed to demonstrate that, in its current state, the installation can be decommissioned avoiding any pollution risk and to return the site of operation to a satisfactory state. The plan should be kept updated as material changes occur. However, even at an early stage, the closure plan can include:
 - o either the removal or the flushing out of pipelines and vessels where appropriate, and the complete emptying of any potentially harmful contents;
 - o plans of all underground pipes and vessels;
 - o the method and resources necessary for the clearing of lagoons;
 - o the method for ensuring that any on-site landfills can meet the equivalent of surrender conditions;
 - o the removal of asbestos or other potentially harmful materials, unless agreed that it is reasonable to leave such liabilities to future owners;
 - o methods for dismantling buildings and other structures, for the protection of surface water and groundwater at construction and demolition sites;
 - o testing of the soil to ascertain the degree of any pollution caused by the activities and the need for any remediation to return the site to a satisfactory state, as defined by the initial site report.

Cross-media effects

None reported.

Technical considerations relevant to applicability

Techniques mentioned here are applicable throughout the installation's operational lifetime, during the design and building stage of the site, and immediately after the site closure.

Economics

N but it is possible to minimise excessive costs during later decommissioning.

Driving force for implementation

Reduction of future costs and liabilities.

Example plants

No information provided.

Reference literature

[237, UBA (A) 2004], [245, France 2008], [288, UK 2002]

2.13 Emerging techniques

Emerging techniques are reported here only for the common processes described above in Chapter 2. Emerging techniques for other processes are reported in the subsequent chapters.

2.13.1 The LUREC and BAYQIK processes

The following emerging techniques have been identified for the conversion of gases with a high SO₂ content into sulphuric acid.

Description

- LUREC[®] process
- BAYQIK[®] process

Technical description

The addition of an extra pass that is external to an existing contact plant can be used to uprate an existing sulphuric acid plant to use higher inlet concentrations of sulphur dioxide.

The LUREC[®] process uses an additional contact chamber with one or two beds, depending on the inlet gas concentration. This acts as a pre-converter, and a heat exchanger and a pre-absorption stage can then be used before the existing plant. Inlet sulphur dioxide concentrations between 15 % and 25 % have been tested.

The BAYQIK[®] process uses a series of concentric tubes where the catalyst and support are contained in the inner tube, and the outer ring acts as the heat exchanger. The process is shown in Figure 2.36.

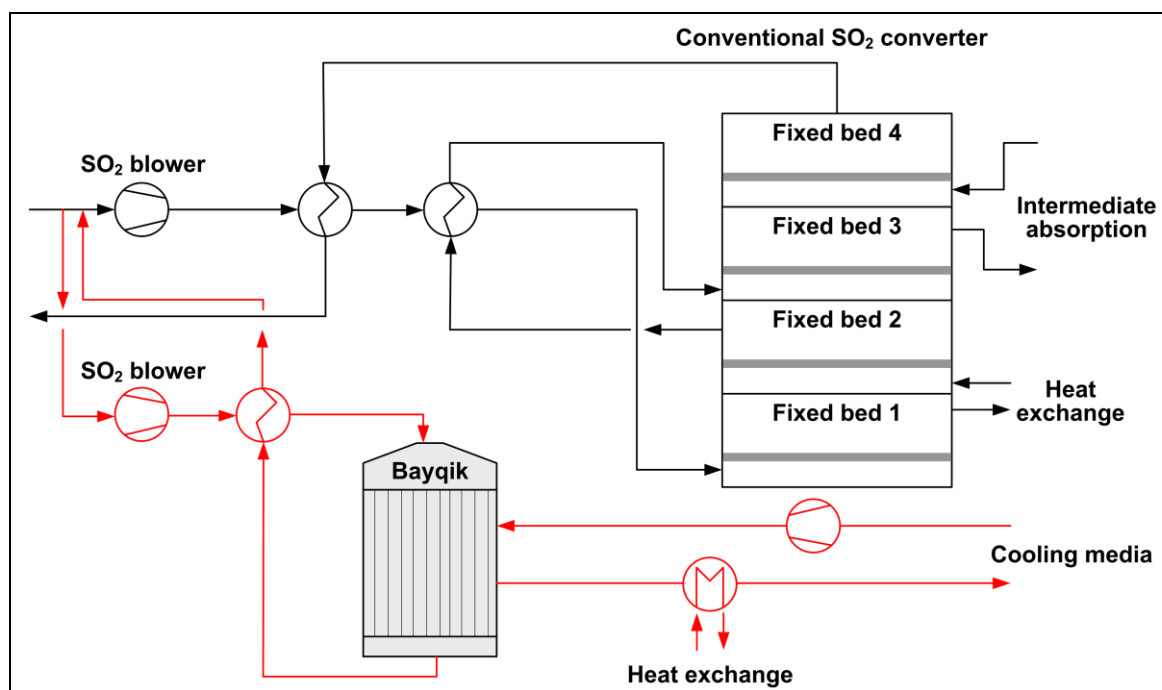

Figure 2.36: The BAYQIK process

Achieved environmental benefits

- Reduction of SO₂ emissions.
- Increase of the overall efficiency of an existing sulphuric acid plant, and higher inlet gas concentrations can be used to keep the overall gas flow low.

Cross-media effects

None reported for the additional process.

Operational data

The LUREC[®] process has been in operation since the summer of 2007 at a Chinese smelter, Yanggu Xiangguang Copper, Shandong Province, China (nominal capacity 2340 t/d), where an additional pre-contact pre-absorber unit precedes a five-pass double contact/double absorption sulphuric acid plant to give overall a seven-pass triple contact plant. This is a greenfield plant operating with an inlet concentration of 16–18 % SO₂.

The BAYQIK[®] process adds an extra external stage to an existing sulphuric acid plant that comprises a catalyst bed with an integrated heat exchanger. The plant was commissioned in 2009 in Stolberg, Germany but no performance data were available in January 2010.

Applicability

The LUREC[®] process is available and can be used as an additional bed for all existing plants, to give six or seven passes and triple absorption if the inlet gas concentration requires.

Economics

The LUREC[®] process costs are given as EUR 8 million for an addition to a 121 000 Nm³/h gas flow at an SO₂ inlet concentration of 20 %. The capital cost comparison between the LUREC[®] add-on module and a conventional plant is given in Table 2.27.

Table 2.27: The capital cost comparison between the LUREC[®] add-on module and a conventional plant

Item	Unit	Amount	
		Conventional plant	Add-on LUREC [®] plant
Existing capacity	tonne/d	2000	NA
Existing smelter gas flow	Nm ³ /h	51 700	NA
Existing gas flow to inlet of plant	Nm ³ /h	143 000	NA
Inlet SO ₂ concentration	vol-%	13.0	NA
Additional capacity required	tonne/d	600	NA
Future gas flow required at 13 % inlet SO ₂ concentration	Nm ³ /h	185 600	NA
Estimated cost for 600 t/d plant	EUR	11 000 000	NA
Future capacity required	tonne/d	1240	1360
Gas flow from smelter at 36 % inlet SO ₂ concentration	Nm ³ /h	67 200	
Gas flow to inlet of plant	Nm ³ /h	120 000	121 000
Inlet SO ₂ concentration	vol-%	9.5	20
Estimated capital cost for 1360 t/d LUREC [®] module	EUR	NA	8 000 000

NB: NA = Not applicable.

The BAYQIK[®] process costs are given as EUR 7.5 million for a plant to take 50 % of the side-stream from a 25 000m³/h process.

Driving force for implementation

An increase in plant throughput without replacement.

Example plants

Yanggu Xiangguang Copper, Shandong Province (China), and Stolberg (DE).

Reference literature

[274, COM 2008], [326, Daum et al. 2005]

3 PROCESSES TO PRODUCE COPPER AND ITS ALLOYS FROM PRIMARY AND SECONDARY RAW MATERIALS

3.1 Applied processes and techniques

3.1.1 Primary copper production

Primary copper can be produced by pyrometallurgical or hydrometallurgical processes. Approximately 20 % of primary copper is produced by the direct leaching of ores (hydrometallurgical route). Nowadays, sulphidic concentrates (15–45 % Cu) are the most important raw materials for the pyrometallurgical primary copper route, with a share of more than 85 %. To a small extent, oxidic/sulphidic mixed ores and, more seldom, bituminous ores are processed. The sulphidic concentrates consist of complex copper/iron sulphides; they are derived by flotation from ores that contain 0.2–2 % copper. Further inputs used for primary copper production are fluxes (silicate, lime, sands, etc.), additives/reactants (iron, carbon, etc.) and recycled materials (scrap, dross, lime sludges, used abrasive materials, slags, dusts, etc. [234, UBA (D) 2007]. The generic processes are discussed below.

3.1.1.1 The pyrometallurgical route

The pyrometallurgical route entails a number of steps, depending on the concentrate used. The majority of concentrates are sulphidic and the stages involved are roasting, smelting, converting, refining and electrorefining. Overviews of all of the furnaces mentioned in this section are given in Annex 13.1 and more detail is provided here where needed [90, Traulsen, H. 1998]

3.1.1.1.1 Concentrate to matte smelting

Concentrates are dried to reduce the moisture content from 7–8 % to about 0.2 % prior to the smelting process. For smelting in shaft furnaces, concentrate is dried to 3.5–4 % and briquetted.

There are two types of dryers used for drying copper concentrates:

- hot gas rotary dryers heated by the off-gases from combustion;
- steam-heated coil dryers.

The rotary dryer is a rotating drum. The hot gas produced by the combustion of natural gas is placed in contact with the wet concentrate and the contained water is transferred to the gas.

The steam dryers are indirectly heated via steam coils. The throughput depends on the steam pressure; by increasing the pressure to 18–20 bar, the capacity can be increased. A small amount of carrier air is introduced to pick up the water of the concentrate.

Roasting and smelting are usually carried out simultaneously in a single furnace at high temperatures to produce a melt that can be separated into a matte (copper sulphide with some iron sulphide) and a slag rich in iron and silica. A fluxing agent that contains silica and, if required, lime (CaO) is usually added to the melt to aid the formation of the slag. The sulphur-based gases generated by this process are directed to on-site acid plants to be used as a raw material in the production of sulphuric acid or, more rarely, the production of liquid SO₂. The smelting stage is used to separate the copper sulphide from the other solids present in ores by the formation of silicates, particularly iron silicates. This reaction depends on the high affinity of copper for sulphur compared to other metallic impurities.

For copper concentrate with a low sulphur content and a high organic carbon content, the smelting may be carried out in a shaft/blast furnace. In such cases, the resulting off-gases with a high energy content could be used as additional fuel in a power plant.

In the case of very impure copper concentrates, partial roasting converts the complex sulphides of iron and copper in the concentrate into simple sulphides, by heating the ore or concentrate under oxidising conditions. The sulphur-based gases generated by this process are directed to an on-site acid plant. The smelting stage is then used to separate the copper sulphide from the other species such as oxides present in ores, by the formation of silicates, particularly iron silicates.

There are two basic smelting processes in use: bath smelting and flash smelting. The flash smelting process uses oxygen enrichment to produce an autothermal (autogenous) or nearly autothermal operation. Bath smelting processes generally use a lower degree of oxygen enrichment. The use of oxygen also gives higher sulphur dioxide concentrations which make the collection of the gas more effective using one of the sulphur recovery systems (usually the production of sulphuric acid or the production of liquid sulphur dioxide). Table 3.1 shows the smelting processes that are used for primary copper production.

Table 3.1: Primary copper smelting technologies

Smelting process	Status of development		Remarks	
	Industrial-scale operation status	Environmental performance: potential or constraints	Production level: potential and/or limitations	Comment
Shaft/blast furnace	Established	Needs to be combined with processes that can recover the energy and sulphur content of the gases	Used specifically for low-grade concentrates with a low sulphur content and a high carbon content	High carbon content makes processing with other technology difficult because of the heat release
Partial roasting and electric furnace smelting	Established	Good	Limitation for production rate	Roaster size may be a limiting factor
Outotec flash smelting and Peirce-Smith converting	Established	Good	Very high smelting rate possible in one unit; depending on the furnace design and the type of concentrates, 400 000 t/yr blister copper is possible	Worldwide the standard primary copper smelting concept still has potential for improvement
Outotec direct blister flash smelting	Established	Good	Three plants in operation, > 200 000 t/yr reached	Applicable to concentrates with low iron/low slag
Ausmelt/ ISASMELT	Established	Good	Upper production rate per unit not tested	Potential for further improvement
INCO	Established	Good	Limitation of proven smelting rate per unit	Size of furnaces installed. Still further potential
Teniente converter, Noranda process	Established	Good	Limitation of smelting rate by reactor size and O ₂ enrichment limits	Compared to other processes, relatively higher ingress air ratio requiring increased effort for process gas capture
Vanyukov process	Six industrial-scale furnaces in Russia and Kazakhstan	Potentially good	No definite analysis available	Information for a substantiated judgement is not available; in general, technology may have considerable potential
Baiyin process	Exact number not known. At least two industrial units in operation	Potentially good	No definite analysis available; information available suggests production rates of up to 75 000 t/yr Cu can be achieved	Information is not available to substantiate. May have considerable potential
Mitsubishi process for continuous copper smelting	Established	Good	So far > 200 000 t/yr production level reached	Potential for further development
Kennecott-	Operating in three	Good	Higher production	Excellent

Outotec flash smelting/flash converting	plants. Fourth plant under construction		rate in a single converter and with a low gas volume	environmental performance and potential for further development
Reverberatory furnace smelting	Established	Somewhat limited	Limitation for smelting rate of one unit	
Noranda continuous converter	Commissioned on industrial scale	Good	No data for final analysis available	Effectively available, potential still to be evaluated when data from operation available
<i>Source:</i> [135, Gershel, T. 1998]				

Bath smelting is carried out in a number of proprietary furnaces such as the reverberatory, shaft (or blast), electric, Ausmelt/ISASMELT, Noranda, Mitsubishi, El Teniente, Baiyin and Vanyukov [21, COM 1991], [25, OSPARCOM 1996], [134, Metallurgical Consulting Traulsen GmbH 1998]. All of the processes rely on the oxidation and smelting processes taking place in a molten bath, with slag and matte separation and tapping taking place in various ways. Some furnaces can operate without the predrying of the concentrate, but the superheated water vapour increases the gas volume and decreases the energy efficiency of the process. The differences between these processes can be significant, for example in the position of air/oxygen or fuel addition points, and some processes operate on a batch basis. Bath smelters are generally operated with a holding furnace or a separate settler. The general descriptions are covered in Chapter 2 and are summarised in Table 3.1. [134, Metallurgical Consulting Traulsen GmbH 1998]

Flash smelting is carried out in either the Outotec or INCO flash furnace [21, COM 1991], [25, OSPARCOM 1996], [134, Metallurgical Consulting Traulsen GmbH 1998]. The Outotec and cyclone processes use oxygen enrichment and the INCO process uses pure oxygen. Flash smelting relies on the oxidation and smelting of dry concentrates in airborne particles. The reacted particles fall into a settling chamber where the separation of the matte and slag takes place, sometimes additional fuel is used in the settler to maintain the temperature. Matte and slag are subsequently tapped and processed further, and the gases pass from the furnace through a vertical chamber or uptake shaft to a heat exchanger. Oxygen can be fed into the uptake shaft to afterburn combustible dusts and sulphatise metal oxides. The flash furnace is also used to produce blister copper directly.

Top-blown rotary converters (TBRCs) have also been used in the past in primary copper smelting. They are no longer used for primary smelting, mainly due to the high operating costs, though this type of furnace is used for secondary smelting.

The worldwide use of the smelting technologies is shown in Table 3.2.

Table 3.2: Worldwide use of the smelting technologies for primary copper production

Process	Blister production (1000 t/yr)
Outotec flash smelting	5815
ISASMELT	2255
Ausmelt	1430
Outotec flash smelting & flash converting	1120
Mitsubishi	990
Teniente	846
Reverberatory furnace	795
Outotec direct blister	740
Shaft/blast furnace	670
Inco flash furnace	345
Others & unknown	2375
<i>Source: [382, Holding 2012]</i>	

The reverberatory furnace is also used for matte smelting but not within the EU-28. It does not use the energy content of the sulphur and the iron in the concentrate but instead relies on the use of fossil fuel to melt the concentrates via the hot combustion gases sweeping over the hearth. The process is therefore not as efficient as the other processes described. The combustion gases add to the overall gas volume and result in a very low sulphur dioxide content, which is very difficult to remove effectively. The use of reverberatory furnaces has declined significantly since the 1970s. The SO₂ content of the off-gases is normally very low so they cannot be treated in an acid plant.

The overall process to produce copper from primary raw materials is shown in Figure 3.1.

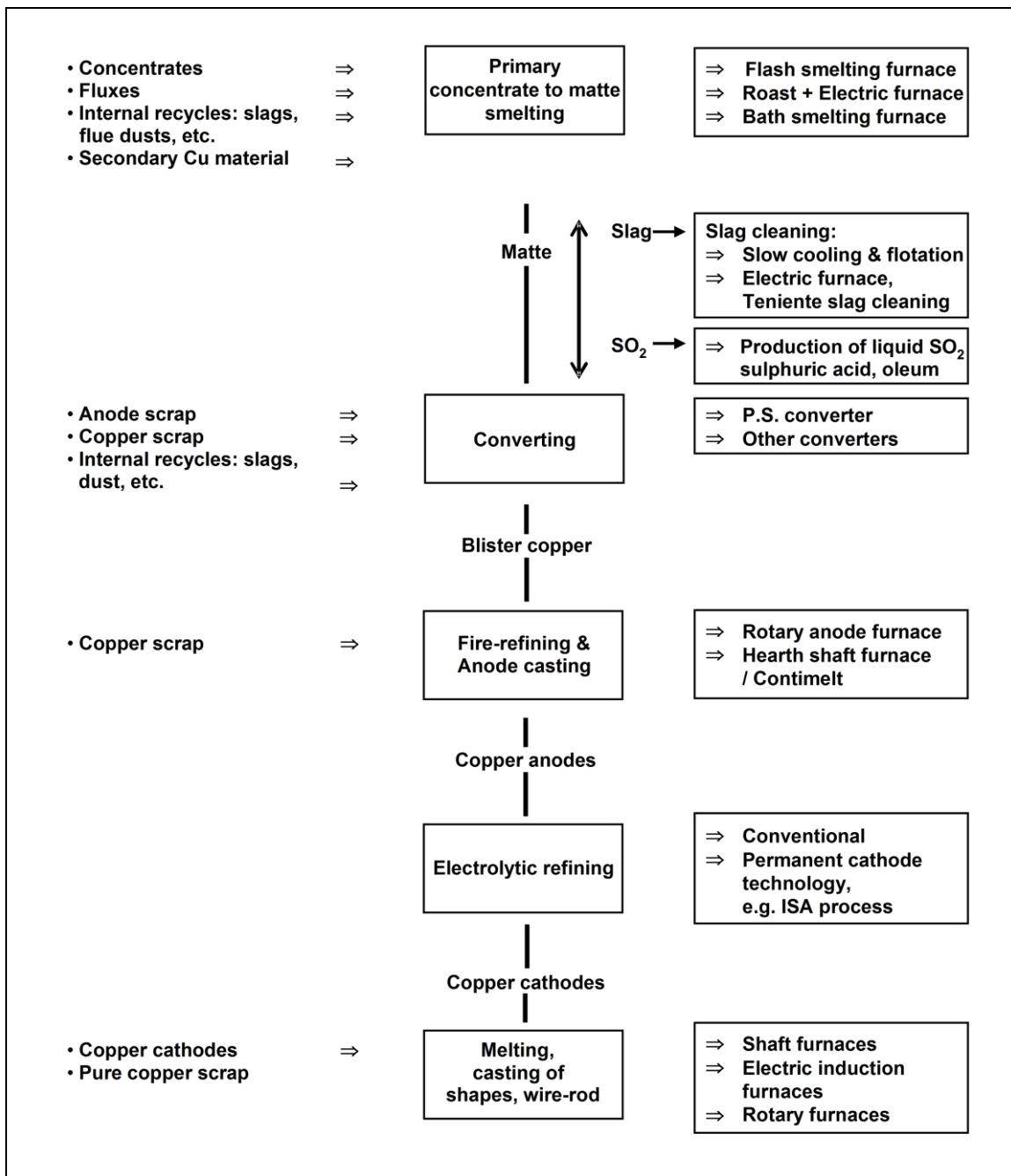

Figure 3.1: Primary copper production

3.1.1.1.2 Converting

Three types of converter processes are used during primary processes; two are matte conversion processes and one is an alloy conversion. The matte conversion processes are the conventional batch process, which is most commonly used, and the continuous converting process [135, Gershel, T. 1998].

Batch matte converting process

The batch converting process comprises two stages. It is carried out by blowing an air/oxygen mixture through the matte recovered from the smelting operation. A cylindrical bath furnace is most commonly used [21, COM 1991], [25, OSPARCOM 1996] and flux additions are added. In the first stage, iron and part of the sulphur are oxidised and slag and sulphur dioxide gas are formed; the slag is skimmed off periodically and is further processed to recover copper. Normally the first stage blow is carried out in several steps with incremental matte additions. In

the second stage, i.e. the copper blow, the copper sulphide is oxidised to blister copper (98.5 % Cu) and more sulphur dioxide gas is formed. The blister copper is tapped at the end of the copper blow. The process is operated to control the residual sulphur and oxygen in the blister copper. The sulphur dioxide that is formed is further treated for sulphur recovery, normally in a sulphuric acid plant.

The reaction is strongly exothermic and also volatilises metallic impurities such as lead and zinc that are then captured in an abatement plant and recovered. The process heat can also be used to melt anode scrap and other copper scrap without the addition of primary heat. The sulphur dioxide concentration varies during the different stages of conversion, depending on the stage of the converting and on the type of furnace used.

The Peirce-Smith and the Hoboken type converters are operated batch-wise, (they are referred to as Peirce-Smith or similar converters in this chapter). They are cylindrical bath furnaces with laterally arranged tuyères for air/oxygen blowing. [21, COM 1991], [25, OSPARCOM 1996]. The Ausmelt/ISASMELT furnace has also been used for the batch-wise conversion of matte into blister copper. Top-blown rotary converters (TBRCs) have been used in the past for batch-wise conversion of primary copper material to blister copper but are no longer in use.

Continuous matte converting process

The continuous converting processes that are in industrial use are the Kennecott-Outotec flash converting furnace [52, Newman, C.J. et al. 1998], [62, Helle, L. et al. 1994] [66, George, D.B. et al. 1995], the Mitsubishi furnace (which forms part of the integrated Mitsubishi process) and the Noranda converter [135, Gershel, T. 1998].

The Mitsubishi and the Noranda furnaces receive molten feed for conversion. In contrast, the Kennecott-Outotec process is as follows: matte from a smelting furnace is first granulated in water, crushed and dried. The material is then blended with slagging agents and fed into the concentrate burner of a specific flash furnace using an oxygen-rich atmosphere; conversion takes place in the airborne particles. The process produces a high and constant concentration of sulphur dioxide which is recovered. Slag and blister copper are tapped for further processing. The use of ground matte allows the matte quality to be balanced with the feed rate and degree of oxygen enrichment to produce the optimum conversion efficiency, and this also allows the matte production and conversion stages to be decoupled.

There are significant differences between batch-wise and continuous converter concepts in operation and in sulphur dioxide output throughout the converting cycles. There are also variations in the ease of collecting fumes during charging and in the ability to melt scrap anodes. Most processes rely on ladles for the transfer of matte, slag and blister copper and diffuse emissions may result. In one case, the ventilation gases from the converter aisle are collected and treated, in another case, an intelligent secondary fume collection system is used [198, Velten 1999]

Alloy converting process

Alloy converting is a batch process in which alloy from the electric furnace serving a direct-to-blister flash furnace is treated. One converter cycle lasts about eight hours. About 5–6 tonnes of limestone per batch is added to help the slagging of the oxidised iron and lead in the first converter stage. To prevent the over-oxidation of copper, a small amount of coke (0.1–1 t) is added per batch. When the lead content drops below 2 %, the second blow starts and silica is added to the converter to bind PbO. The process ends when the Pb content drops below 0.3 %. The converter off-gas is handled in a dedicated wet cleaning system and the slurry which contains 55–65 % Pb is utilised in a lead recovery plant.

3.1.1.1.3 Fire refining (anode furnace)

Fire refining is a further purification step applied to the crude metal (blister copper) produced by the conversion stage. The refining step involves the addition of air and then a reducing agent (e.g. hydrocarbons) to reduce any oxide present. [21, COM 1991], [25, OSPARCOM 1996], [90, Traulsen, H. 1998].

Fire refining is achieved by first blowing air through the molten metal to oxidise impurities and to remove final traces of sulphur (oxidation stage). A small amount of slag is produced at this stage that needs to be removed prior to the next stage. In the next stage (reduction or 'poling'), a source of reducing agent, such as natural gas or propane, is then added to partially remove the oxygen that is dissolved in the liquid copper. Ammonia may also be used as a reducing agent, but has been reported to increase NO_x levels [292, Kojo et al. 2006]. Historically, wooden poles or logs were used as the source of reducing agent (and are still used in a small number of cases) hence the process is termed poling. Several installations use an afterburner to treat the gases during the poling stage.

In primary and some secondary smelters, cylindrical rotary furnaces (anode furnaces) are used for fire refining. These furnaces are similar to the Peirce-Smith converter and use tuyères for gas additions. They are charged with molten copper, copper scrap and anode scrap. Some secondary processes use a reverberatory furnace with lances for air additions, and they are fed with solid or molten copper (converter copper or copper scrap). Some reverberatory furnaces are tiltable and are fitted with tuyères. Hot gases from anode furnaces are often used for drying, oxygen evaporation or other uses. Stirring of the molten copper is sometimes achieved by blowing nitrogen through porous plugs in the furnace. This improves homogeneity and increases efficiency [265, AJ Rigby et al 1999].

A TBRC can also be used for the fire refining stage, and here only the reduction/poling step takes place in the rotary anode furnace.

A continuous melting and refining process (Contimelt) is applied to melt and treat blister copper, high-grade copper scrap and anode scrap to produce copper anodes. It combines the melting step and the fire refining steps (oxidation and reduction) with casting in one continuous operation, achieving high energy efficiency in all steps and a reduction of emissions.

Combinations of hearth shaft furnaces (fed with solid material for batch-wise melting) and rotary furnaces (for batch-wise reduction) are also used. These systems can be applied for primary (blister) and secondary (scrap) materials.

The metal from the anode furnace is then cast into anodes. The most commonly used technique is a casting wheel that comprises a series of anode-shaped moulds on the circumference of a rotating table. Molten metal first flows into a tundish from where it is metered into the moulds to obtain a consistent anode thickness and the wheel rotates taking the anodes through a series of water jets to cool them. The anodes are automatically removed from the moulds and are placed into cooling tanks to prevent the metal's oxidation. Casting rates range up to 200 tonnes per hour.

As an alternative to the 'stop-to-cast mould' on a wheel system, copper anodes are also produced continuously using a Hazelett twin belt caster. A copper strip with the desired anode thickness is produced. From the strip, anodes can be obtained by shearing it into the traditional anode shape or, according to the Contilanod® system, by casting anode lugs in special side dam blocks spaced in defined intervals in the caster. The preformed anode plates are cut off using a plasma torch or special shears. The advantage of this method is the uniformity of the anodes produced; however, the system requires careful maintenance and the operating costs are comparatively higher.

3.1.1.1.4 Electrolytic refining

An electrolytic cell is used and it consists of a cast copper anode and a cathode placed in an electrolyte that contains copper sulphate and sulphuric acid. The cathode is either a thin blank of pure copper (starter sheet) or a stainless steel former sheet (permanent cathode plate) (Mount ISA process, Outotec permanent cathode system and Noranda/Kidd Creek system). [21, COM 1991], [25, OSPARCOM 1996], [90, Traulsen, H. 1998], [258, Finland input 2007]. At a high current density and low voltage, copper ions are dissolved from the impure anode and pass into solution from where they are deposited onto the cathode. Copper is removed from the anode to the extent that the remaining anode is still mechanically strong enough to prevent a collapse. The remaining anode is then recycled to the production process, usually the converter, to cool the reaction and recover the copper. When using permanent cathode plates, the pure copper deposits can be stripped and then, in the same way as solid copper cathode plates, melted and cast into the required shape.

During electrorefining, other metals contained in the anodes are separated; less noble metals like nickel are dissolved in the electrolyte and more noble metals like the precious metals, selenium and tellurium form an anode slime that settles in the electrolytic cells. Anode slimes are periodically removed from the cells and the valuable metals recovered (see Chapter 7, precious metals).

The concentration of the other dissolved metals will increase in the electrolyte, as they are not deposited on the cathode. To remove the impurities dissolved during electrorefining, part of the electrolyte is bled from the system for purification. Typical purification processes use copper electrowinning, or in some plants copper is recovered as copper sulphate. Evaporation, crystallisation and further refining recover nickel as nickel sulphate. The following techniques are used for the treatment and elimination of arsenic: solvent extraction; precipitation during the final copper electrowinning; precipitation from the black acid. In some cases, copper arsenate is produced and is recycled to the smelter feed.

The removal of impurities during electrorefining aims to produce a cathode copper with a quality at least equal to or better than the grade A quality standard of the London Metal Exchange. In Table 3.3, an example is shown of the anode composition and the cathode quality achieved. It should be noted that the level of impurities in the anode affects the cathode quality; the impurity level in anodes also depends on the source of the concentrate or secondary material.

Table 3.3: Example of impurity removal levels during electrorefining

Element	Content in anode ⁽¹⁾ (g/t)	Content in cathode (g/t)
Silver	600–720	9–10
Selenium	50–510	< 0.5
Tellurium	20–130	< 0.5
Arsenic	700–760	< 1
Antimony	330–700	< 1
Bismuth	60	< 0.5
Lead	990–500	< 1
Nickel	1000–5000	< 3
⁽¹⁾ Anode quality depends on raw material contents. Source: [121, Rentz, O. et al. 1999]		

The current trend is for larger cells with a greater number of electrodes to be used in the tank house and for stainless steel cathode formers to be used [90, Traulsen, H. 1998]. A gain in efficiency is seen when these factors are coupled with good quality control of anodes. Quality

control is needed to ensure that anodes are straight, flat, have good electrical contact and have been adequately fire refined. Similarly, there is also an improvement in cathode quality using stainless steel blanks, as fewer impurities are mechanically carried over and subsequently incorporated into the cathode. These cathode blanks give an increase in current efficiency to 97 % or even more. Modern tank houses use a high degree of automation for cathode and anode changes and for stripping cathode deposits from permanent cathode plates) [21, COM 1991], [25, OSPARCOM 1996]. Mechanically prepared copper starter sheets can also be used instead of stainless steel blanks.

Copper electrowinning is described in Section 3.1.2.2.

3.1.1.1.5 Treatment of copper-rich slags

The slags produced from primary smelting with high-grate matte and converting stages are rich in copper and are subjected to a number of slag treatment processes [90, Traulsen, H. 1998]. One process is the use of an electric furnace for the reaction of slag with carbon in the form of coke breeze or with the electrodes themselves and for the settling of copper matte that is formed, to produce an inert slag. The electric furnaces can be operated continuously or on a batch basis. Converter slag can also be returned directly to the smelting furnace.

Alternatively, flotation processes are used after the slag has been slow-cooled, crushed and milled, and the flotation concentrate obtained is a copper-rich portion which is returned to the smelter. This method is only used where sufficient space is available and where the tailings can be adequately treated and disposed of.

An electric furnace is also used for the treatment of the concentrate separated by slow-cooling and flotation of the converter slag.

Slags from the slag treatment processes are used for civil engineering projects, road construction, river embankments and similar applications, as well as in shot blasting, as they often have properties that are superior to alternative materials. Fine material is used as a filler in cement production.

Other slags rich in copper, like refining slags, are normally recirculated to a prior process stage, mostly to the converting stage, or, in secondary smelters, to the smelting stage.

3.1.1.2 The hydrometallurgical route

This process is usually applied to oxidic or mixed oxidic/sulphidic ores at mine sites where there is sufficient space for the leaching and treatment areas. The process is particularly useful for ores that are difficult to concentrate by conventional means and which do not contain precious metals [54, Biswas, A.K. et al. 1976], [55, Kojo, I.V. et al. 1994], [134, Metallurgical Consulting Traulsen GmbH 1998]. Some proprietary processes have been developed such as the Outotec L-SX-EW® and HydroCopper® processes [261, Nyman et al. 2002], [308, Haavanlammi 2007], [309, Pekkala 2007].

A generic hydrometallurgical flowsheet is shown in Figure 3.2.

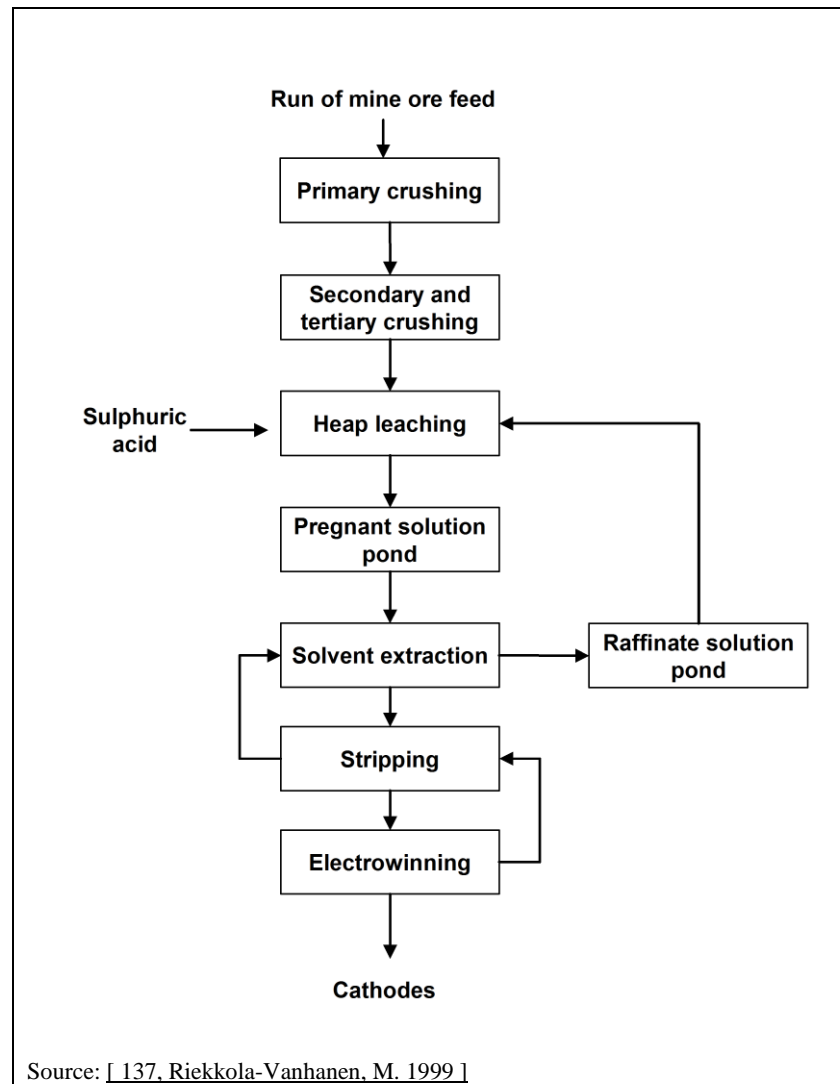

Figure 3.2: Flowsheet of a hydrometallurgical process

The hydrometallurgical route involves the crushing of the ore followed by leaching using sulphuric acid, sometimes in the presence of biological species, using heap, vat or agitation processes [134, Metallurgical Consulting Traulsen GmbH 1998]. The liquor produced from leaching is then clarified and purified and concentrated by solvent extraction. The copper in the organic solution is then stripped by sulphuric acid. The stripped solution, containing mainly copper sulphate, is sent to the electrowinning stage.

3.1.2 Secondary copper production

Secondary copper is produced by pyrometallurgical processes. The process stages used depend on the copper content of the secondary raw material, its size distribution and the other constituents [90, Traulsen, H. 1998] [121, Rentz, O. et al. 1999]. As in primary copper, the various stages are used to remove these constituents and to recover metals to the greatest possible extent from the residues that are produced [219, VDI 2007].

Secondary feed material can contain organic materials like coatings, or be oily in nature, and installations take this into account by using de-oiling and decoating methods or by the correct design of the furnace and the abatement system. The aim is to accommodate the increase in combustion gas volumes, destroy VOCs and to minimise the formation of PCDD/F or destroy them altogether. The type of pretreatment applied or the furnace used depends on the presence of organic materials, the type of feed, i.e. copper content and other metals content, and whether the material is oxidic or metallic.

If a furnace such as a converter is used to smelt impure brass scrap to separate the metals contained in it, the alloying elements are fumed from the copper to produce black copper and a zinc-rich filter dust.

A wide range of secondary raw materials are used and some of them are described in Table 3.4.

Table 3.4: Secondary raw materials for copper production

Type of material	Cu content (wt-%)	Sources
Mixed copper sludges	1–25	Electroplating
Computer scrap	15–20	Electronics industry
Copper mono-sludges	2–40	Electroplating
Copper-iron material (lumpy or comminuted) from armatures, stators, rotors, etc.	10–20	Electrical industry
Brass dross, ashes and slags that contain copper	10–40	Foundries, semi-finished product plants
Red brass dross, ashes and slags that contain copper	10–40	Foundries, semi-finished product plants
Shredder material	30–80	Shredder plants
Copper-brass radiators	60–65	Cars
Mixed red brass scrap	70–85	Water meters, gear wheels, valves, taps, machine components, bearing boxes, propellers, fittings
Light copper scrap	88–92	Copper sheets, eaves, gutters, water boilers, heaters
Heavy copper scrap	90–98	Sheets, copper punchings, sliderails, wires, pipes
Mixed copper scrap	90–95	Light and heavy copper scrap
Copper granules	90–98	From cable comminution
Pure No 1 scrap	99	Semi-finished products, wire, cuttings, strip

Source: [121, Rentz, O. et al. 1999]

The stages used for secondary copper production are generally similar to those for primary production but the raw material is usually oxidic or metallic and process conditions are therefore varied. Smelting of secondary raw materials consequently uses reducing conditions.

3.1.2.1 Secondary copper smelting stage

A number of furnaces such as the blast furnace, mini smelter, top-blown rotary furnace (TBRC), sealed submerged electric arc furnace, Ausmelt/ISASMELT furnace (KRS or Kayser recycling system), reverberatory and rotary furnace are used for low- and medium-grade material [26, McLellan and Partners Ltd 1993], [90, Traulsen, H. 1998] [121, Rentz, O. et al. 1999]. Contimelt systems are used for high-grade copper scrap (> 99 % Cu).

The type of furnace and the process steps used depend on the copper content of the secondary raw material, its size and other constituents. The smelting and refining of secondary copper is therefore complex and the type of secondary material which can be processed is dependent on the particular facilities and furnaces available [90, Traulsen, H. 1998]. Details of furnaces are given in Chapter 2. The secondary copper production route is shown in Figure 3.3.

Iron (in the form of irony copper, normal iron scrap, etc.), carbon (in the form of coke or natural gas) and fluxing agents are added to reduce metal oxides if required and the processes are operated to suit the feed material. Reduction smelting results in the volatilisation of mainly zinc, tin and lead, which are discharged as oxides with the off-gas and are collected in the dust collection system. The content of dust, sulphur dioxide, PCDD/F and VOCs in the fume from the furnaces depends on the raw materials. For a further clean-up after dust separation, the off-gas can be routed to a contact process sulphuric acid production unit after additional wet scrubbing [219, VDI 2007]. The collected flue-dust is sent to further processing to recover the metals separated from the input materials.

The mini smelter is also used for secondary copper production, using scrap that contains iron and tin. In this application, the iron acts as the reducing agent in the first stage to produce metallic copper and then oxygen is blown into the melt to oxidise iron and the other metals (lead and tin) present which are recovered in the slag. The oxidation of the iron content provides the heat to drive the process and excess heat is recovered.

The KRS process uses the Ausmelt/ISASMELT furnace (see Section 13.1.2.7) [234, UBA (D) 2007]. The combination is an advanced technology which replaces the conventional blast furnace/converter technology in non-ferrous metals recovery from secondary raw materials. Typical input materials include copper- and precious-metal-bearing secondary raw materials from copper smelting and refining, copper casting plants, the metal processing industry or from recycling plants for copper-bearing materials such as electric and electronic scrap, copper alloy scrap, copper-rich slags, copper dross, filter and cyclone dust, precipitation sludges and wire-drawing sludge.

In principle, electric furnaces process the same materials as the KRS or the blast furnace. The electric furnace requires a lower material input per tonne of black copper output than the blast furnace which, unlike electric furnaces, cannot normally be operated without producing slag.

3.1.2.2 Converting, fire refining, slag treatment and the electrorefining and processing of pure alloy scrap

The converting and refining furnaces used are the same as those used for primary copper production, and the slag treatment systems and electrorefining processes are also the same. The main difference is that converters used for secondary production treat metal and not matte. These furnaces usually use natural gas as fuel and coke as the reducing agent for melting and to make up process heat deficits, while in the primary converters the matte provides the necessary process heat [90, Traulsen, H. 1998]. Secondary converters also oxidise and convert to slag minor elements like iron, and separate other metals like zinc or tin by volatilisation. They produce a converter copper of a quality that suits fire refining. The heat of the reaction when air is blown into the converter is used to volatilise metallic components; slagging agents are used to

remove iron and some lead. Fire refining furnaces are also used to melt higher grade scrap. There are potential sources of diffuse emissions from secondary converters.

The electrorefining slimes and spent solutions are also sources of precious metals and other metals such as nickel. These are recovered in the same manner as those from primary production.

Copper alloys such as bronzes and brasses are also used as secondary raw materials in a number of processes. If impure or mixed with other alloys, they are processed in the secondary smelting and refining circuits as described in Section 3.1.2.1 above [219, VDI 2007].

The pure alloy is used directly for semis fabrication. Induction furnaces are used to melt the clean material followed by casting into shapes suited for the further fabrication step. Charge analysis and control are practised to produce the desired alloy without major additions of virgin metal. Zinc oxide can be collected from the filter dust.

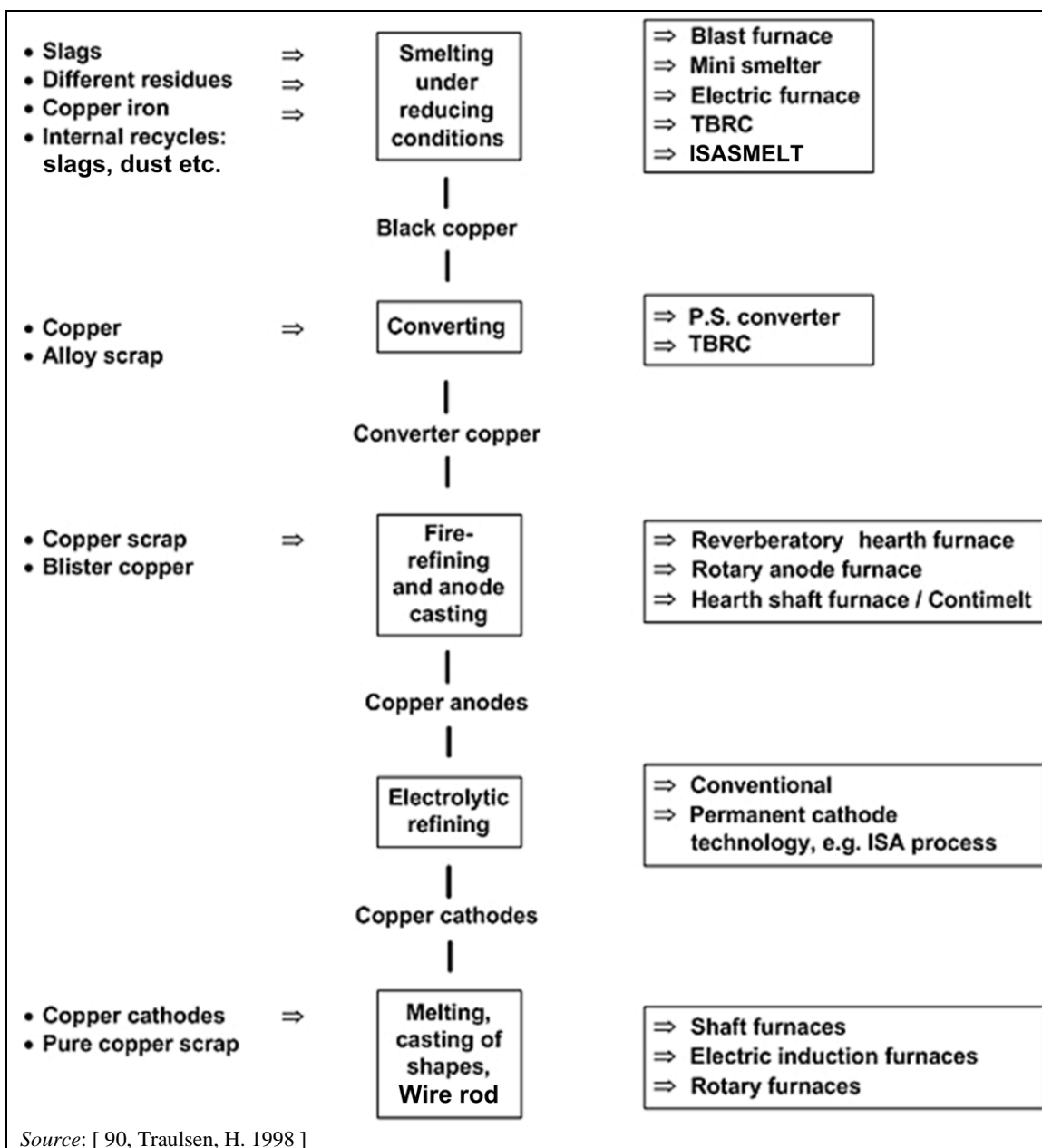

Figure 3.3: Generic flowsheet for secondary copper production

Depending on the type of feed materials in some plants, a flue-dust is produced in the first stage that is rich in zinc and lead, for example during the blast furnace smelting of lower grade material. These dusts contain up to 65 % combined zinc and lead and are a highly suitable feed material for processing in lead and zinc production processes.

A further variation of leaching is used by Umicore in Belgium where copper matte is produced in an Ausmelt/ISASMELT furnace. In a second step, the copper matte remaining in the furnace is converted to blister copper and poured into the refining furnace, where it is further refined to obtain the correct blister quality. The blister is then granulated and the granules are dissolved in an autoclave and the pure copper is electrowon from the resulting solution, [228, COM 2007], [238, ECI 2012].

Electrowinning is used to recover copper from copper sulphate solutions produced by the leaching of impure copper or a hydrometallurgical solvent extraction process. The electrowinning process uses an insoluble anode, such as lead or titanium, and stainless steel blanks or copper starting sheets as cathodes. The copper ions are removed from the solution and deposited on the cathode in the same manner as electrorefining. Cathodes are then stripped in the same way if permanent cathode blanks are used. The electrolyte is circulated through a series of cells and finally is depleted of copper. The electrolyte is then returned to the solvent extraction circuit. Some electrolyte is normally bled for the control of impurities, which might have been carried over during solvent extraction.

Due to the decomposition voltage, the voltage of an electrowinning cell is approximately five times higher than in a refining cell. When electrowinning is used to recover copper from copper sulphate solutions, part of the solution has to be bled for arsenic and nickel removal.

3.1.3 Wire rod production

Wire rod is manufactured from high-purity electrorefined copper cathodes, thus ensuring that trace impurities, which may affect conductivity, annealability and hot shortness, are minimised. Attention is paid to controlling the furnace conditions to minimise oxygen absorption into the metal. The processes are described below [114, Eurometaux 1998].

3.1.3.1 Southwire process

Shaft furnaces are used for melting copper cathodes and other pure copper scrap material. Melting rates of up to about 60 t/h are achieved. An example of the Southwire process is shown in Figure 3.4.

The feed materials are melted by natural gas, propane or similarly fired burners arranged in rows around the furnace shell. The fuel is burnt under closely controlled combustion conditions to maintain a slightly reducing atmosphere (less than 0.5 % to 1.5 % of CO or H₂) in the areas where the gases are in contact with the copper, to minimise the oxygen content of the copper. This is achieved by independent control of the fuel to air ratio for each burner by monitoring the CO or H₂ content of the combustion gases from each burner in turn.

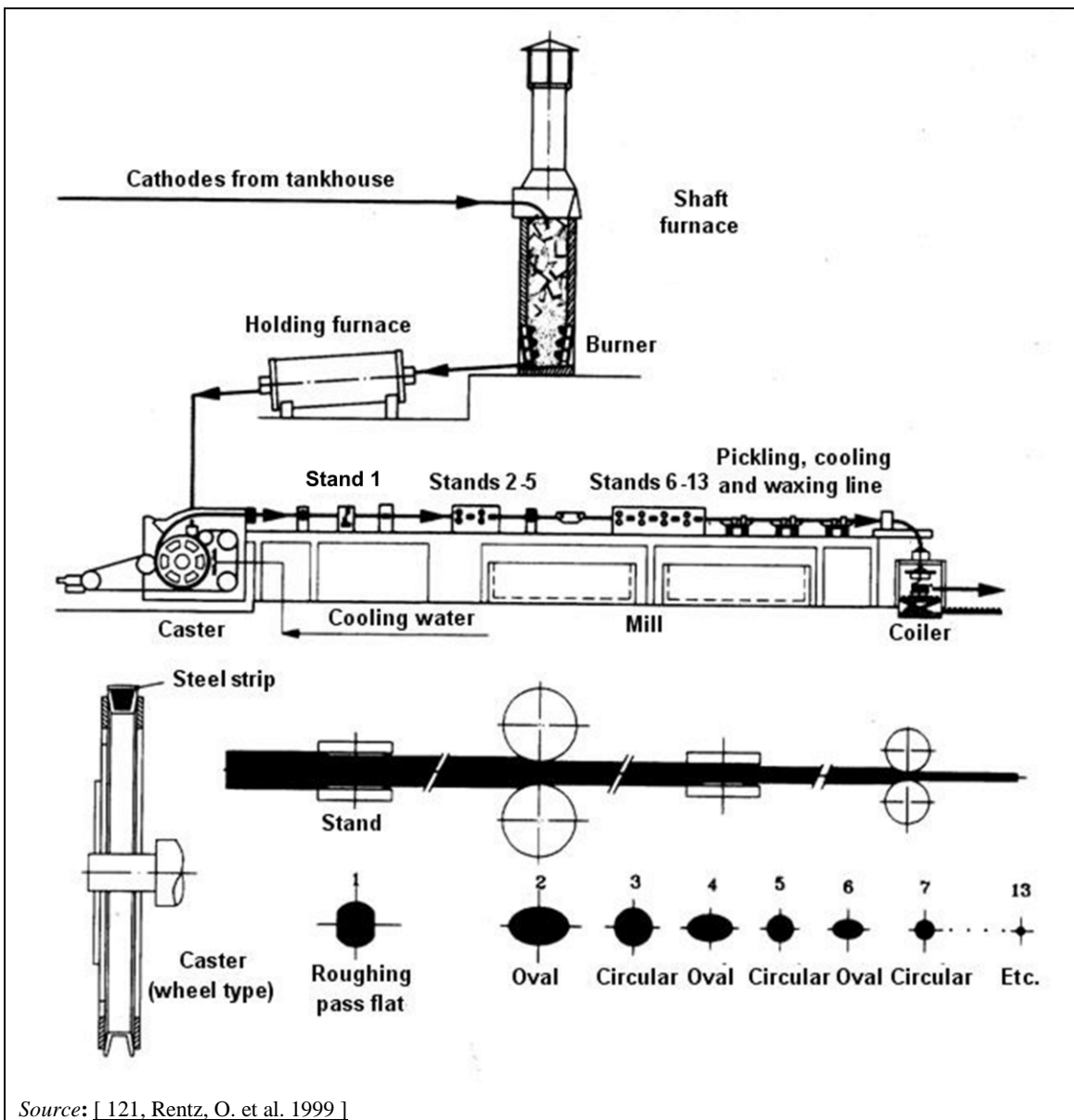

Source: [121, Rentz, O. et al. 1999]

Figure 3.4: Example of the Southwire process

Gases from the furnace are cooled and dust is removed using fabric filters. Afterburning can also be used to destroy CO if the concentration is high.

Molten copper is discharged from the base of the shaft furnace and flows to a cylindrical holding furnace for temperature adjustment and balancing of the metal and for metallurgical treatment. Natural-gas-fired burners are provided to maintain the temperature of the molten copper and a reducing atmosphere in the launders. The holding furnace, which is also fired with natural gas or a similar fuel, serves as a reservoir to provide a constant flow of metal to the casting process and, if required, it can be used to superheat the metal.

Molten copper flows from the holding furnace via a tundish equipped with flow control to the casting wheel. A water-cooled steel band encloses over half of the circumference of the wheel, forming the casting cavity into which the molten copper solidifies to form a trapezoidal cast bar ranging between 5000 mm² and 8300 mm². Acetylene, burnt with air, is used to produce a soot dressing for the casting wheel and steel band. After being levelled and shaved, the cast bar is fed by pinch rolls to a rolling mill, consisting of a roughing section and a finishing section, which reduces the bar to its final diameter. A mineral oil emulsion or synthetic solution in water is used as a rolling fluid [219, VDI 2007].

3.1.3.2 Contirod process

A shaft furnace as described above is used to melt copper. Molten copper from the furnace flows via a launder equipped with siphons into a rotating, gas-heated holding furnace. The copper then flows to the pouring funnel, which automatically controls the feeding rates to the caster [114, Eurometaux 1998]. An example of the Contirod process is shown in Figure 3.5.

A twin belt Hazelett casting machine can also be used [121, Rentz, O. et al. 1999], [219, VDI 2007]. Here, the two belts are cooled by a continuous film of water that moves at high speed along the length of their surface. The side blocks are automatically cooled in a specially designed cooling area located on the return strand of the loop. Depending on the plant size, the cast bar area can range between 5000 mm² and 9100 mm² and production capacities between 25 tonnes and 50 tonnes per hour. The rectangular bar is cooled, the four corners are milled to remove any flash, and the bar then enters a rolling mill comprising alternate horizontal and vertical passes to produce a final product. A mineral oil emulsion or synthetic solution in water is used as a rolling fluid.

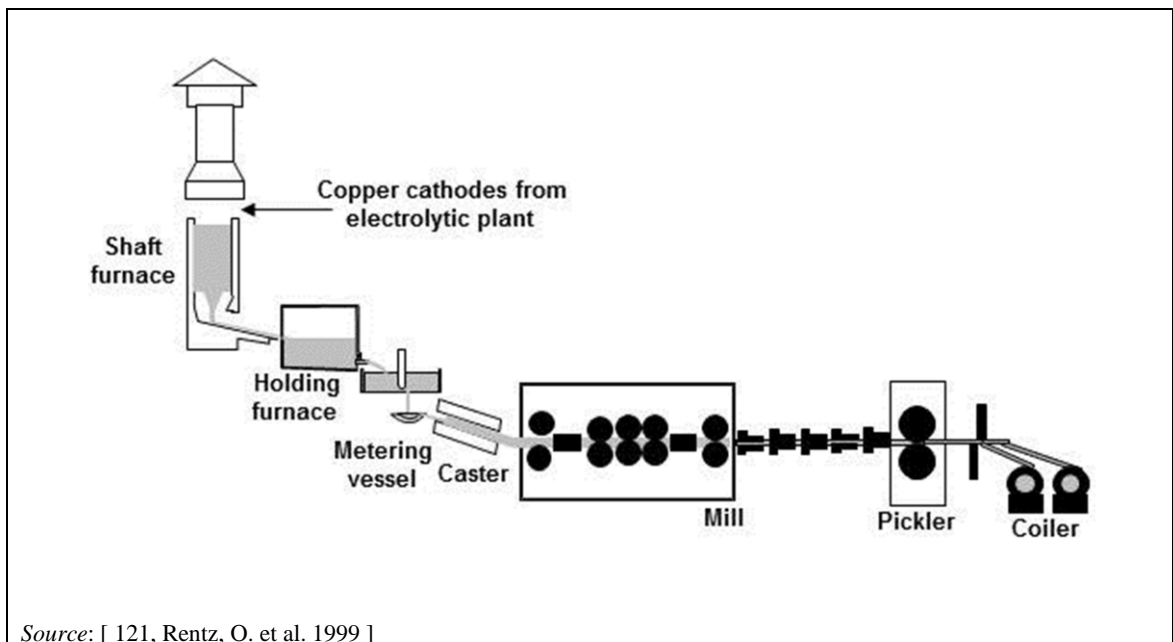

Figure 3.5: Example of the Contirod process

3.1.3.3 Properzi and Secor processes

The continuous Properzi and Secor processes are similar to the Southwire process (see Section 3.1.3.1) with variations in casting geometry [114, Eurometaux 1998]. The features described for the Southwire process are also valid for these two copper wire rod fabrication systems.

3.1.3.4 Upcast process

Copper is melted in a channel induction furnace. The melt is transferred in batches into an induction holding furnace. For small production capacities, a single combined melting-holding furnace may be sufficient [114, Eurometaux 1998].

The Upcast withdrawal machine is located above the holding furnace. Water-cooled graphite dies are submerged a certain depth into the melt and the molten copper runs continuously into

the dies, where it solidifies and is drawn up to the pinch rollers. The solidified wire rod is pulled upwards by the pinch rollers.

3.1.3.5 Dip-forming process

The preheated feed material is discharged into a channel induction melting furnace. Copper passes to the holding furnace and the crucible that is attached to the holding furnace. A mother rod, 12.5 mm in diameter, is drawn through an inlet die at the base of the crucible. Drawing the core wire through the metal pool and controlling the final diameter through the upper die increases the diameter. The cast rod is directed via dancers to a three-stand rolling mill producing 8.0 mm and 12.5 mm rods [114, Eurometaux 1998].

3.1.4 Production of semi-finished products of copper and copper alloys

Copper and copper alloys are melted continuously or in batches and cast for the production of shapes suited to the further fabrication step [219, VDI 2007]. The cast products are precursors for a variety of materials such as sheets, strips, sections, bars, rods, wires and tubes.

A general flowsheet for semi-finished product fabrication is shown in Figure 3.6.

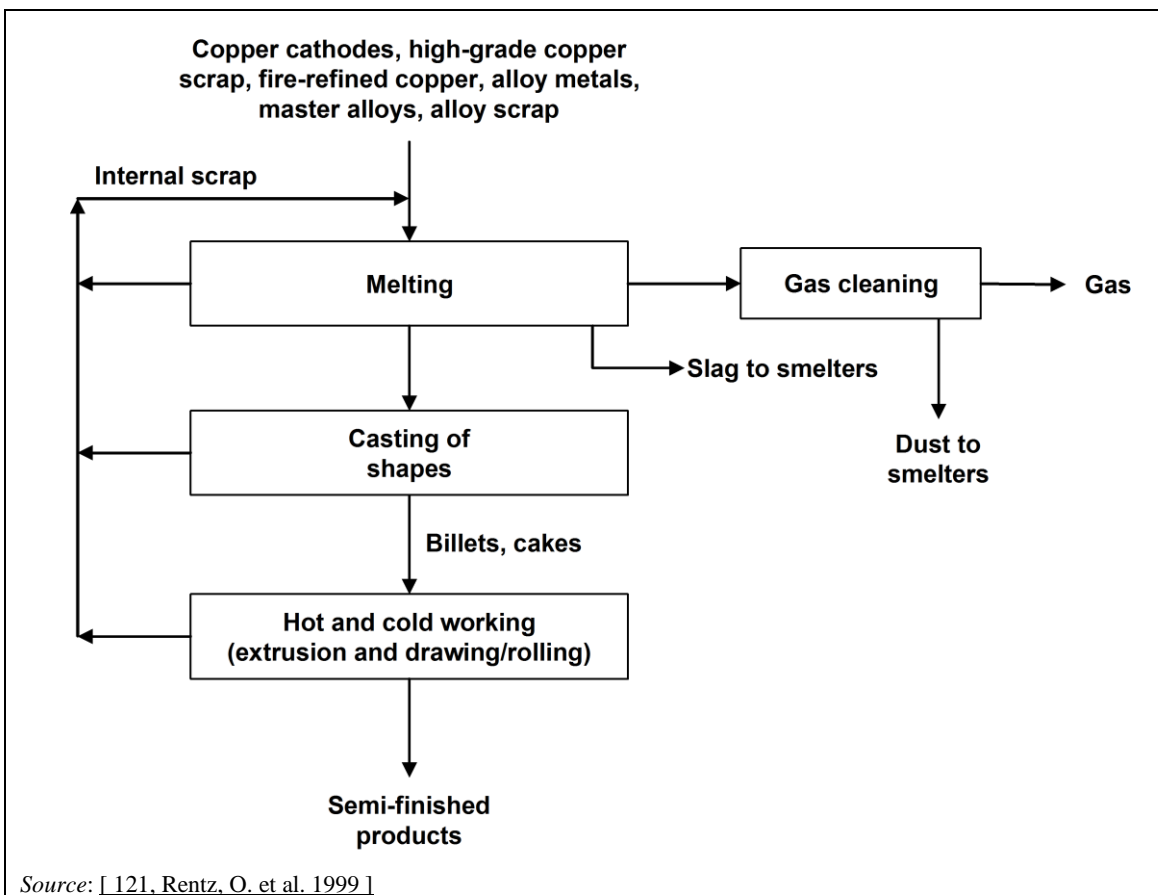

Figure 3.6: General flowsheet for semi-finished product fabrication

3.1.4.1 Melting processes

Copper or copper alloys can be melted in batches in an electric or induction furnace (crucible or channel type). When high melting rates are required, copper is also melted continuously in a shaft furnace. Crucible or reverberatory furnaces are also used for melting and fire refining copper. The fume collection and abatement systems are chosen according to the raw material and the degree of contamination present. The gas collected from electric furnaces is normally cleaned in cyclones followed by fabric filters. For gas-fired shaft furnaces, the control of the burners is a critical factor to minimise the CO content of the gases emitted. An afterburner followed by heat recovery systems is in use if the CO content is high enough (e.g. > 5 % CO); fabric filters are also used for dedusting in shaft furnaces.

Copper cathode and copper and alloy scrap is used as the raw material and is normally stored in open bays so that the different alloys can be blended to produce the final alloy. This preblending is an important factor to reduce the time taken to prepare the melt, which also minimises the energy used and reduces the reliance on expensive master alloys. With induction furnaces, scrap is cut into small sizes to improve the melting efficiency and to allow the easy deployment of hoods, etc.

Raw materials also include brasses or copper turnings and borings, and in this case they are coated with lubricants. Care is taken to prevent oil leaking from the storage area and contaminating groundwater and surface water. Similarly, swarf dryers or other furnaces and solvent or aqueous de-oiling methods are used to remove lubricants and other organic contaminants [219, VDI 2007].

When brasses or bronzes are melted, zinc is fumed from the furnace; good control of the temperature can minimise this. Fume is collected in the gas extraction system and removed in a fabric filter. The zinc oxide is normally recovered. A degree of fire refining is also carried out and the resulting fumes are taken into account in the design of the fume collection and abatement systems.

3.1.4.2 Casting

Normally, molten metal from the furnace or holding section can be cast continuously or in batches [114, Eurometaux 1998]. Continuous casting uses either vertical or horizontal modes while discontinuous casting normally uses the vertical mode. Upcast techniques are also used. Billets and cakes/slabs are produced and are processed further.

The principle of continuous or semi-continuous casting is given in Figure 3.7.

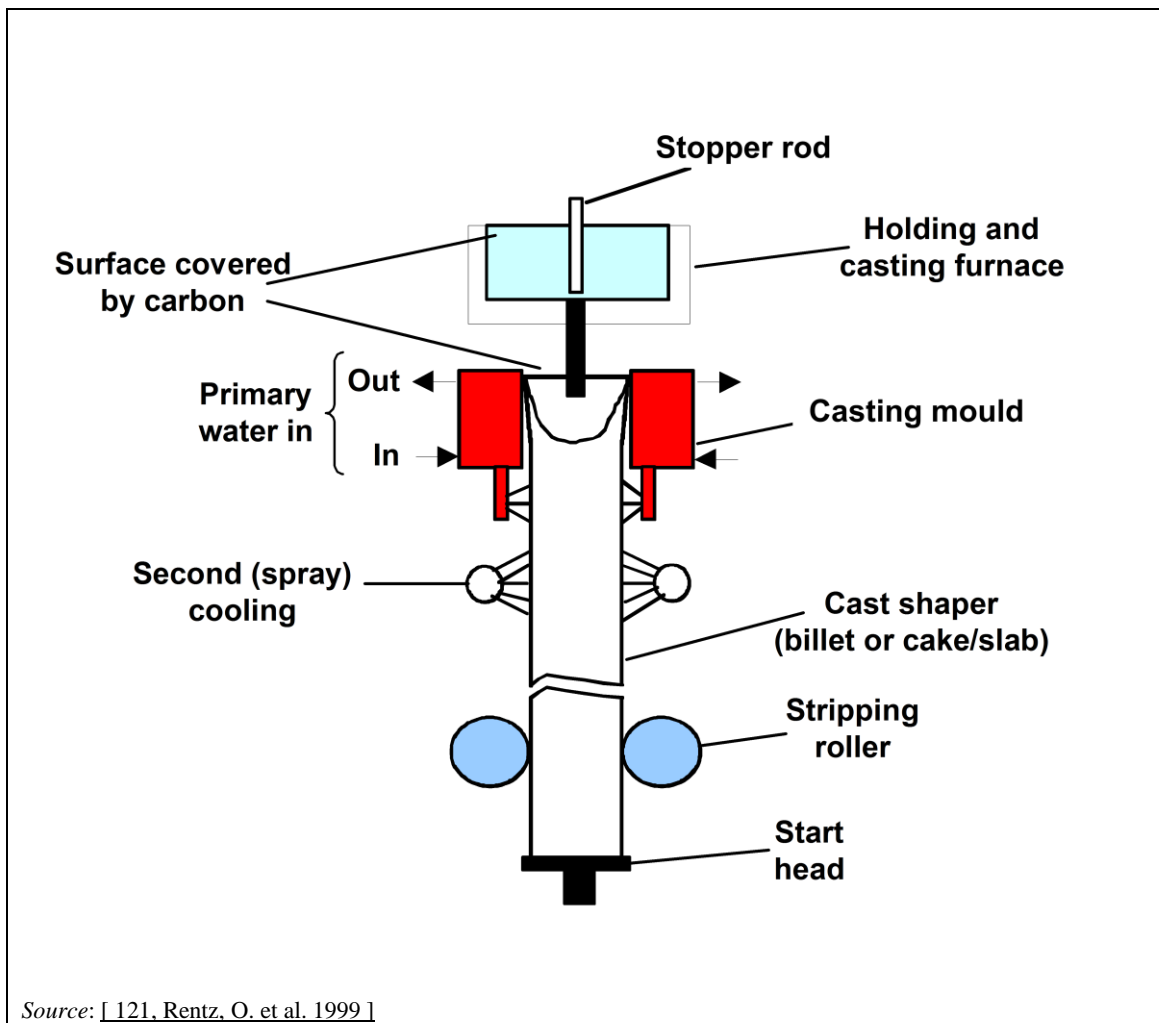

Source: [121, Rentz, O. et al. 1999]

Figure 3.7: Principle of continuous or semi-continuous casting

The normal shapes produced by casting are as follows [114, Eurometaux 1998].

- billets are mostly made from copper and copper alloys for the production of tubes, rods and sections using continuous or discontinuous casting;
- slabs or cakes are cast from copper and copper alloys for the production of sheets and strips using continuous or discontinuous casting.

Metal is melted and passes via a holding furnace into a vertical or horizontal billet caster. Sections of billets are sawn off for further fabrication. Special processes are applied for specific products from copper and copper alloys:

- the Upcast process for wires and tubes;
- horizontal continuous casting for strip and sections;
- vertical strip casting and rolling processes for the fabrication of copper tubes.

The strand cast on vertical or horizontal casting units is cut using the flying saw technique. In a discontinuous casting unit, the format length is determined by the depth of the casting pit. After reaching the maximum format length, casting is interrupted and the cast shapes are extracted by a crane or elevator. In the case of continuous casting, it is not necessary to interrupt the casting process. All casting operations need direct cooling water for final solidification and cooling down the cast strand to temperatures suitable for further handling. The cooling water can be recycled after sedimentation and the separation of solids (casting scales). If the scales are not

contaminated with graphite or other particles, they are recirculated to a smelter for processing, if not directly reused in the casting shop.

A comparison of the plant data for typical vertical and horizontal continuous casting installations is given in Table 3.5.

Table 3.5: Comparison of the plant data for typical vertical and horizontal continuous casting installations

Parameter	Vertical continuous casting	Horizontal continuous casting
Ingot diameter	70–1500 mm	150–400 mm
Capacity	8 t/(h and strand)	8 t/(h and strand)
Casting rate	80–800 mm/min	80–200 mm/min
Casting temperature	980–1200 °C	980–1200 °C
Operating mode	One or a number of strands	One or a number of strands
Withdrawal cycle	Continuous	Continuous or cyclical
Secondary cooling	Using sprayed water	Does not necessarily use sprayed water, although this is possible
Type of mould	Copper mould, graphite mould	Graphite mould

Source: [121, Rentz, O. et al. 1999]

3.1.4.3 Fabrication of tubes, sections and rods

The fabrication process lines can be subdivided into two product groups, with each product group following the same process steps:

- copper tubes in straight lengths and coils;
- copper (alloy) tubes, as well as copper and copper alloy rods, bars, wires and sections.

In both cases, the starting materials for the fabrication process are copper or copper alloy billets. The billets in the first stage are electrically or indirectly preheated by gas-fired units and then pressed in unfinished tubes using hydraulically operated extrusion presses [219, VDI 2007]. For the fabrication of copper tubes, depending of the type of product to be fabricated, different processes are industrially applied:

- tube extrusion followed by multi-step drawing to size;
- tube extrusion followed by breakdown rolling followed by several steps of drawing to size;
- hot piercing mill followed by breakdown rolling and drawing to size.

For billets which are extruded or rolled into tubes with thick walls, breakdown rolling is normally the preference for the first size reduction step.

For tubes extruded to thin walls, tube drawing machines are applied.

For the fabrication of copper alloy rods, bars, wires and sections, the processes that are normally used are material extrusion in coils or straight lengths followed by cleaning and pickling, drawing to size (using drawbenches or continuous drawing machines), heat treatment for certain alloys, and straightening and sawing.

The whole process, starting with the extrusion press or the hot piercing mill, is a sequence of (mostly) reducing steps changing the shape and size. During these processing steps, the tools of the equipment for size and shape changing are cooled and protected by adequate media, using emulsions for the breakdown rolling and lubricants for the drawing units. The emulsions for the breakdown rolling are cleaned by filtration, thus increasing the lifetime and reducing the amount

of lubricant to be disposed of after treatment. However, the lubricants used for the drawing steps are completely lost with the product and no oily materials have to be rejected from the drawing processes.

The products are normally annealed and degreased before transport and the offcuts are de-oiled in a furnace or other degreasing processes before being returned to the furnace for melting. Products are annealed in a variety of furnaces under reducing conditions using (as the protection gas) exogas or hydrogen/nitrogen mixtures.

Copper tubes may also be produced utilising an extrusion press with a piercer in which billet sections are extruded to tube shell pieces; the tube shell pieces are then rolled in a breakdown roller (pilger mill) and finally drawn to size in drawing blocks. The oil utilised (in small quantities) for the drawing operations is neutralised using in-line degreasing/pickling systems often connected with the annealing section.

3.1.4.4 Fabrication of sheets and strips

Slabs and cakes from the casting shop are, in most cases, the starting material for the fabrication of sheets and strips. The key elements of the fabrication process for flat products are the hot and subsequent cold rolling operations. In detail, the fabrication process comprises the following steps:

- preheating;
- hot rolling and milling;
- cold rolling;
- intermediate annealing;
- pickling, rinsing and drying;
- re-rolling and strand annealing;
- finishing:
 - sheets (cutting to length),
 - strips (cutting to width).

The hot rolling of the cast slabs takes around 15 to 20 slabs until the final shape is reached, which is determined by the slab weight. There is no loss of metal during hot rolling, so slab and coil weight are identical. The hot rolling mill does not require protection gas. The noise development during rolling is controlled by protective measures [234, UBA (D) 2007].

Hot rolling is usually done with a dual rolling mill equipped with benches of up to 200 metres and a final coiling device. The cooling water for the rolls has small amounts of lubricant added to improve the attachment to the steel rolls. The vapour generated is vented and the vent gas is demisted prior to release to atmosphere.

Further cold rolling operations are then performed. Cold rolling results in a hardened metal. In most cases, the coil is annealed prior to cold rolling. Annealing is done under reducing conditions to avoid oxidation. A protection gas of exogas or nitrogen/hydrogen mixtures is used. Exogas is produced on site from natural gas in a special reactor, which is indirectly fired. Nitrogen and hydrogen are purchased and stored on site in special tanks. The N_2/H_2 protection gas mixtures are produced from the storage tanks by mixing the components in the ratio required. For annealing before cold rolling, bell-type furnaces are used; these are electrically heated or indirectly fired by natural gas or fuel oil. Tower-type furnaces are applied for intermediate annealing of pre-rolled coils.

The sheet thickness is further reduced by stepwise cold rolling operations on different reversing mills. For cold rolling, different types of mills called Duo, Quarto, Sexto and Sendzimir (12 rolls) are used. Rolling mill designs such as single-stand mills which are combined with an in-

line multi-stand rolling mill are also applied. The choice of mill used depends on the thickness of the sheet and on the desired dimensions of the coil.

During cold rolling, an emulsion or oil is used for roll protection. Therefore, the roll stands are vented and the ventilation gases are cleaned by mechanical filters, wet electrostatic precipitators or scrubbing. The emulsion and the oil is cleaned from the metal and cracked oil particles are removed by paper or textile band filters.

Typical data for a process to produce brass strip are given in Table 3.6.

Table 3.6: Typical data for a process to produce brass strip

Hot rolling	Process data
Type of mill	Mainly Duo
Initial dimensions	250–130 mm thickness, 450–1000 mm width
Final dimensions	15–12 mm thickness, 450–1000 mm width
Temperature	750–800 °C
Rolling force	~ 10–12 kN/mm sheet width
Surface milling	0.3–0.7 mm cutting of both surfaces
First cold rolling	
Type of mill	Mainly Quarto
Rolling force	~ 15–20 kN/mm sheet width
Dimension reduction and rolling speed	Reduction 15 mm to 4 mm thickness in multiple passes, speed 100–200 m/min
Conversion ratio	70–80 %
Annealing ⁽¹⁾ (recrystallisation)	
Temperature	550–600 °C
Second and final rolling	
Type of mill	Mainly Quarto, or alternatively, depending on sheet thickness, Sexto or stands where 20 rolls are used
Rolling force	~ 2–10 kN/mm sheet width, depending of type of mill used
Rolling speed	Reduction 4 mm to 1 mm: 300–500 m/min, multiple passes or reduction 1 mm to 0.1 mm: 500–1000 m/min, multiple passes
Cutting of sheets into strips	
Type of equipment	Longitudinal strip cutting machine
⁽¹⁾ Annealing is required after every conversion ratio of more than 70–80 %; annealing temperatures selected depend on the material properties to be achieved. <i>Source:</i> [121, Rentz, O. et al. 1999]	

3.1.5 Production of copper and copper alloy ingots

Ingots of copper or its alloys are produced for the foundry industry using a fixed mould casting process. A wide variety of alloys are produced with other metals such as nickel, tin, zinc and aluminium.

The production of ingots requires the production of an accurate alloy composition. This is achieved at the raw material reception and storage stage by segregation and sorting. Old scrap is normally stored in open bays so that the different alloys can be blended to produce the final alloy. Preblending is an important factor to reduce the time taken to prepare the melt, which minimises the energy used and reduces the reliance on expensive master alloys. Copper or copper alloys can be melted in batches in rotary or induction furnaces. Rotary furnaces are

normally used for dirtier scrap, and oxy-fuel burners are also used frequently. Fluxes can be added to separate unwanted components, in particular iron, and the slag is tapped separately from the metal. The yield of metal ranges from 70 % to 97 %, but depends on the raw materials used [103, COM 1998].

The fume collection and abatement systems are chosen according to the raw material and the degree of contamination present. Access to an induction furnace for charging and tapping means that a movable hooding system is used. The hoods are robust so that they can withstand some mechanical impact. The gas collected from induction furnaces is normally cleaned in cyclones followed by fabric filters. An afterburner followed by a heat recovery system can be used for cases where there is organic contamination. Alternatively, the furnace combustion control system should be able to accommodate the combustion of contaminants.

When brasses or bronzes are melted, zinc is fumed from the furnace, but a good level of control of the furnace temperature can minimise this. Fumes are collected in the gas extraction system and are usually removed in a fabric filter. The zinc oxide is normally recovered. A degree of fire refining is also carried out to adjust the alloy composition, and the resulting fumes are taken into account in the design of the fume collection and abatement systems.

The furnace melt is sampled and analysed and final alloy adjustments are made. The metal is then tapped into covered launders that feed a chain of ingot moulds. The moulds are normally treated with a mineral to prevent sticking and oil fumes are produced. Oil can be collected and burnt.

Cooled ingots are stacked, bound and stored in the open on pallets.

3.1.5.1 Master alloys

The furnace charge is normally pre-adjusted to suit the alloy to be used but molten metal can be transferred to a ladle or holding furnace so that the alloy composition can be finely adjusted before casting. Master alloys such as CuP, CuNi, CuZnPb and CuBe are used for this purpose. These master alloys are produced in similar furnaces to those described above; the nature of fumes and dust from the production of master alloys influences the process control, and the collection and abatement systems that are used. More stringent operating and abatement systems are particularly appropriate when extremely hazardous materials such as beryllium are used or when reactive materials such as phosphorus are added to produce an alloy. For example, phosphor copper master alloy is made in the following way: two furnaces (induction furnaces are commonly used) are operated in series; copper is melted in the first furnace and transferred to the second where molten phosphorus is injected by a lance to form the alloy. The rate of injection is controlled to minimise phosphorus pentoxide fume, particularly during the final stages when the metal is approaching saturation ($< 14\% \text{ P}$). The phosphor copper is then tapped into moulds, and phosphorus pentoxide fumes continue to be emitted as the alloy cools if the phosphorous content is too high.

Phosphorus pentoxide is very hygroscopic and as a consequence the fumes cannot be filtered using a conventional bag filter, as the fumes will absorb moisture and coat the bags with phosphoric acid. Conventional wet scrubbing has a limited effect as the fine fumes form a fine mist and fail to contact the scrubbing medium. Effective reduction of the concentration of phosphorous compounds in the gas stream can be achieved by using high-energy Venturi scrubbers or fibrous mat filters. In theory, a weak acid could be produced for further processing, but this is difficult in practice.

3.1.6 Pickling operations

Wire, tube, strip and some other materials are pickled to produce a bright finish before packing or, in the case of copper wire, to remove oxide from the surface prior to wire drawing. Sulphuric acid solutions are used and sometimes a mixture of dilute sulphuric and nitric acids are used. In the latter case, nitric fumes can be emitted if higher strength acids are used.

3.1.6.1 Non-acid pickling of copper rods

This process operates in a sealed circuit. Rods can be pickled in an in-line system that consists of a compartmentalised horizontal steel pipe. A 2.5–5 % solution of isopropanol (IPA) in water is used. The process of converting the cuprous oxide scales with alcohol to form copper (partly left on the rod) is known as the Burns process [114, Eurometaux 1998]. In copper wire rod fabrication, the normal practice is to recycle the solution to the pickling after copper sludge removal by settling or filtration; the IPA concentration is adjusted as required.

After pickling, the rod is dried using compressed air. Then it is given a coating of wax, applied as a fine spray with a 4 % wax emulsion which prevents the oxidation of the surface of the rod. The rod is laid down, coiled onto wooden pallets and compacted, strapped and wrapped in a plastic sheet.

3.1.6.2 Acid pickling of copper rods and semis of copper and copper alloys

Copper wire rod

Acid pickling of copper wire rod uses a compartmentalised horizontal stainless steel pipe [114, Eurometaux 1998]. In a first stage, the rod is pickled with diluted sulphuric acid; then the residual acid is washed in several stages from the rod surface by water sprays, followed by drying using compressed air and then coating with wax.

Alternatively, after partial cooling in a long water-filled tube, the rod is formed into spirals corresponding to the diameter of the coil. These spirals are spread onto a roller table where the temperature is reduced to 20 °C by water sprinklers. An acid-resistant alloy conveyor carries these spirals into the pickling tanks where the rod is pickled with a 20 % sulphuric acid solution. The acid pickling system ensures the perfect removal of all oxides from the rod surface. The loops are then washed with rinsing water and finally protected by a wax solution.

Electrowinning to recover the copper dissolved by the pickling acid is used or the wash solution may also be transferred as make-up to a tank house at the same site or treated by ion exchange.

Semis of copper and copper alloys

The surface pickling of sheets and strips is usually performed with sulphuric acid (8–10 %) but for some special alloys mixtures of sulphuric and nitric acids are used in continuous lines or automatic systems. Gas cleaning is used to remove nitric acid fumes. The acid is changed from time to time in order to ensure that surface quality is not affected [114, Eurometaux 1998].

Spent acid is sent for treatment and for the recovery of metal in internal or external treatment plants. The pickling systems are vented for worker protection. The products are rinsed, the rinse water is then sent for treatment, and the sludges are recycled if possible. For surface degreasing of rolled products, water that contains detergents is used. The spent water is cleaned by ultrafiltration.

3.2 Current emission and consumption levels

The main environmental issues of the refined copper industry are air and water pollution [27, M. Barry et al. 1993], [206, Traulsen, H. 1999]. The facilities generally have their own waste water treatment facilities and waste water recycling is usually practised. Most potential wastes are reused.

Some local aspects, like noise, are relevant to the industry.

Due to the hazardous nature of some solid and liquid wastes, there is also a significant risk of soil contamination unless these wastes are stored and handled correctly.

Diffuse emissions can be highly significant (see Section 2.4). Measurements have been carried out at one major copper smelter producing primary and secondary copper. The results clearly show that diffuse emissions predominate even after improvements were made to secondary fume capture systems [158, Petersen, K. 1999]. In this example, the dust loads that were measured are shown in Table 3.7.

Table 3.7: Comparison of abated and diffuse dust loads at a primary copper smelter

	Dust emission (kg/yr)	
	Before additional secondary gas collection (1992)	After additional secondary gas collection (1996) ⁽¹⁾
Anode production (t/yr)	220 000	325 000
Diffuse emissions:		
• total smelter	66 490	32 200
• smelter roofline	56 160	17 020
Primary smelter stack emissions:		
• smelter/acid plant	7990	7600
• stack-secondary hoods	2547	2116
⁽¹⁾ Emissions after an investment of EUR 10 million into an improved diffuse gas capture and treatment system. Additional energy = 13.6 GWh/yr. Source: [158, Petersen, K. 1999]		

3.2.1 Energy consumption in copper production

Copper production requires energy in most stages, with the energy used in the electrolytic process being the most significant [25, OSPARCOM 1996]. The production energy (net) requirement for a number of processes using copper concentrate is in the range of 14–20 GJ/t of copper cathode [206, Traulsen, H. 1999]. The exact figure depends mainly on the concentrate (percentage of sulphur and iron), but the smelting unit used, the degree of oxygen enrichment and the collection and use of process heat also have an influence. Comparative data based solely on the type of smelter are therefore liable to inaccuracies. The utilisation of the energy content of the concentrate is more important and smelters that achieve autogenous operation have lower energy use.

Increasing the energy efficiency and reduction of external fuel consumption are also achieved by applying techniques to recover waste heat. The hot off-gas produced by the smelting furnace or converting vessel is sent to a waste heat boiler. In the boiler, gas is cooled by generating steam. The steam can be used inside, for example for drying concentrate (in direct steam coil drying, 150–180 kg of steam per tonne of concentrate) or for other process units, or outside for electricity production or district heating. Production of sulphuric acid from SO₂-containing off-gas also produces extra energy that could be recovered using a heat exchanger.

The energy consumed by the electrorefining stage of copper production is reported to be 300–400 kWh per tonne of copper, but the energy used is considerably higher when high-impurity anodes are electrorefined [134, Metallurgical Consulting Traulsen GmbH 1998]. The type of blank cathode used (stainless steel or copper) mainly influences the efficiency of the tank house [90, Traulsen, H. 1998] and this can range from 92 % to 97 % in terms of current efficiency.

3.2.2 Emissions and consumption data

The main sources of emissions and consumption for the production of copper are described below.

3.2.2.1 Primary copper input and output

The input and output data for a primary smelter depend on the copper content of the concentrate, the concentration of other metals (As, Se, Hg, Ag, Au, etc.) and the use of copper scrap or other materials that contain copper in the various parts of the process.

Figure 3.8 illustrates the inputs and potential outputs from a typical process for the production of primary copper and Figure 3.9 shows the gas treatment system.

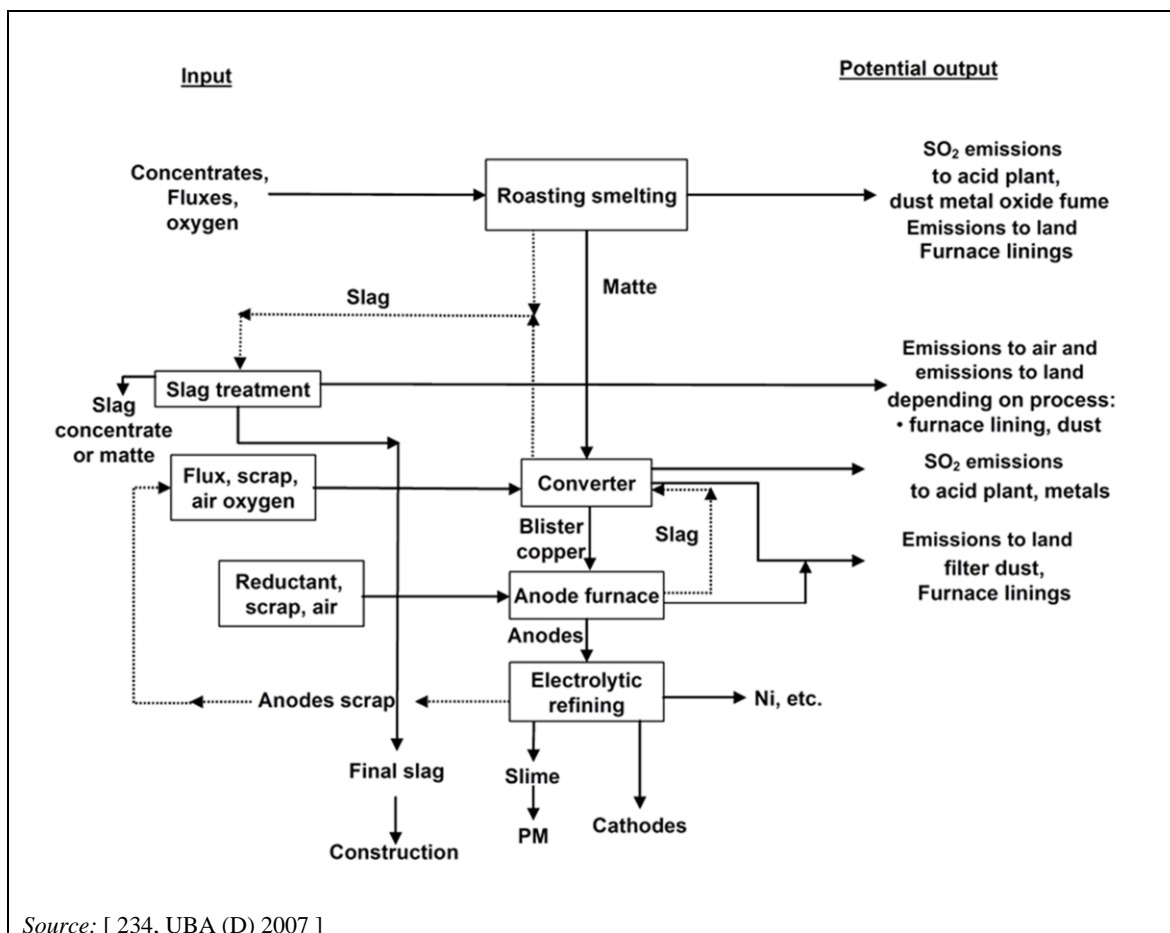

Figure 3.8: Generic input and output diagram for primary copper smelting

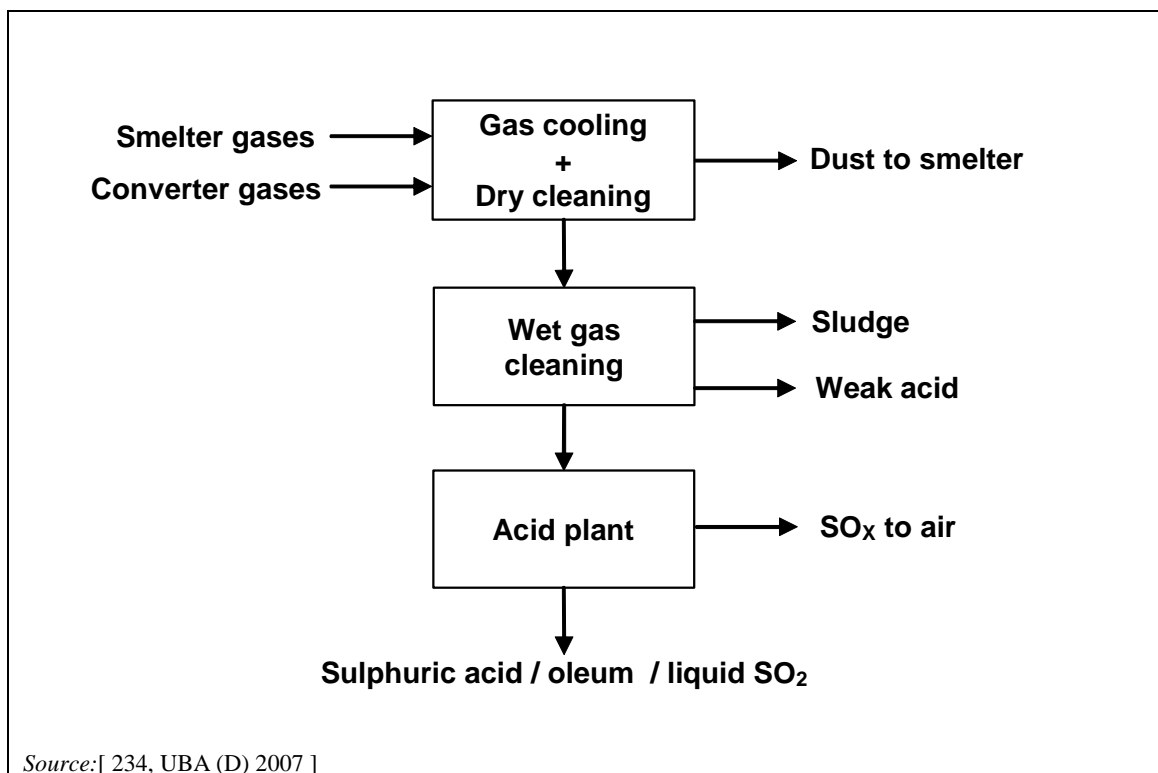

Figure 3.9: Treatment of smelter and converter gases

In the case of concentrate with low sulphur and high organic contents, the off-gases from the roasting/smelting stage are routed to a power plant to recover the energy content and are then desulphurised in a semi-dry scrubber.

Some primary copper smelters are integrated with secondary smelting facilities or with the production of lead or zinc oxide dust from mixed concentrates, etc. The input and output data are therefore very difficult to compare. Values for a complex process are given in Table 3.8 below. It should be noted that the main influence on the input and output data is the copper content of the concentrate or other raw material and so there may be variations in the data and comparisons are hence not significant. The recovery of copper during smelting and refining is more meaningful and is greater than 96 %.

Table 3.8: Example input and output data for a primary copper smelter/refinery

Input materials	Quantity (t/yr)	Products	Quantity (t/yr)
Copper concentrates	1 040 000	Copper cathode	366 000
Copper scrap	65 000	Copper salts	NI
Shredded material from electronic scraps	3600	Nickel sulphate	NI
External intermediate products	56 000	Precious metals	960
		Refined lead	17 000
		Sulphuric acid	1 018 000
		Slags	690 000

NB: NI = No information provided.
 Source: [121, Rentz, O. et al. 1999], [234, UBA (D) 2007]

3.2.2.2 Secondary copper input and output data

As reported above, secondary raw material can be fed into various parts of the secondary processes depending on the purity, contents of other metals and degree of surface contamination [219, VDI 2007]. The degree of organic contamination affects the potential emissions and, in several process stages, afterburners are used to destroy organic compounds such as PCDD/F, depending on the degree of organic contamination present. Figure 3.10 and Figure 3.11 show generic input and output diagrams for secondary copper production.

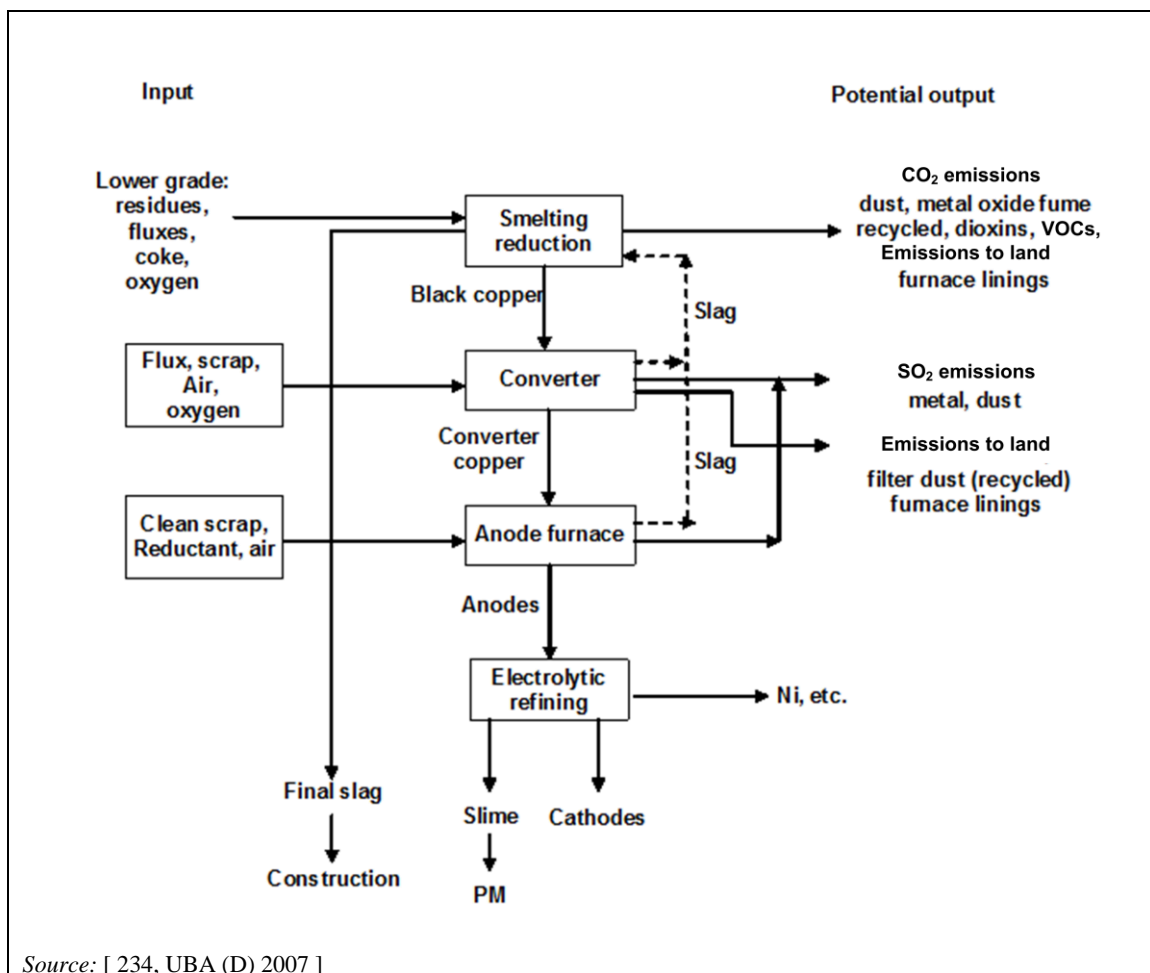

Figure 3.10: Generic input and output diagram for secondary copper smelting

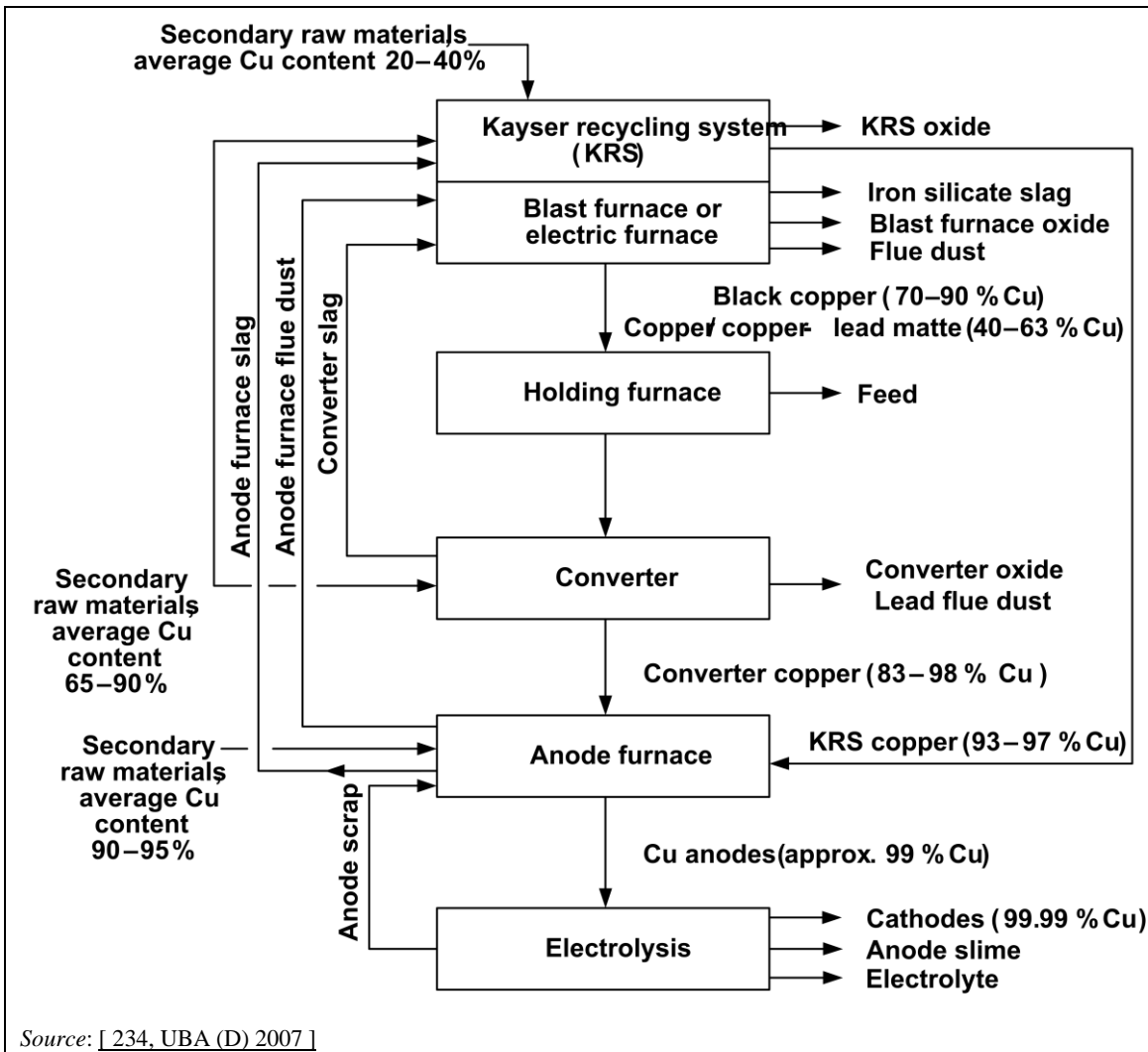

Figure 3.11: Example of an input and output diagram from a secondary copper production site with a tin/lead recovery process

Many residues are recycled within the process and to other associated processes. Producers of non-ferrous metals, for example, lead, zinc and tin, use many of the residues as raw materials for their processes [219, VDI 2007]. Several sites have incorporated on-site processes to recover other metals from these residues.

Table 3.9 and Table 3.10 reflect one example of inputs and outputs of a secondary copper smelter, using a KRS furnace, a lead-tin alloy plant, a reverberatory hearth furnace and electrolysis. The ranges depend on the availability of materials.

Table 3.9: Input and output data for the secondary copper process shown in Figure 3.11

Inputs	Quantity (t/yr)	Outputs	Quantity (t/yr)
Copper scrap	100 000–120 000	Copper cathodes	185 000
Blister copper	10 000–30 000	Copper sulphate	10 500–2000
Copper anodes	0–40 000	Nickel sulphate	2500–3000
Copper alloy scrap	20 000–30 000	Zinc oxides	12 000–15 000
External residues and wastes (e.g. slags, dusts, ashes, sludges, sweeps)	50 000–70 000	Lead-tin alloys	2500–3000
Copper-iron material ⁽¹⁾	Approximately 50 000	Anode slime	1500–1800
Limestone	5000–7000	Slag	100 000–120 000
Silica	10 000–15 000	CO ₂	73 000–103 720
Coke	Approximately 1000		
Fuel (Oil)	20 000–30 000		

⁽¹⁾ Including electronic scrap.
 NB: CO₂ output equivalent to 0.4–0.56 t/t copper.
 Source: [234, UBA (D) 2007]

Table 3.10: Differences in the operating parameters between a KRS furnace and a shaft furnace

Parameter	KRS furnace	Shaft furnace
t steam (GJ)/t burden	0.6 (1.7)–0.7 (2.0)	0.7 (1.8)
Burden throughput (t/h)	25–50 (including iron)	5–20
Volumetric off-gas flow (m ³ /h)	300 000	50 000–100 000
Dust content (mg/m ³)	5000–10 000	20 000–40 000
Main dust constituents (filter dust, depending on operating mode)		
Cu (wt-%)	3–6	< 5
Pb (wt-%)	15–20	10–40
Zn (wt-%)	35–50	30–60
Sn (wt-%)	2–4	1–5
Clean gas		
Dust content (mg/m ³)	1–5	1–5
SO ₂ (mg/m ³)	< 500 (daily) 1500 (peak half-hourly)	10–100
NO _x (mg/m ³)	10–100	30–100
PCDD/F (ng I-TEQ/m ³)	< 0.1–0.4	0.3 with RTO
Off-gas temperature at stack outlet (°C)	80–90	75–90

Source: [234, UBA (D) 2007]

3.2.2.3 Emissions to air

Dust, metal compounds, organic carbon (which can result in the formation of PCDD/F) and sulphur dioxide can be emitted to air [121, Rentz, O. et al. 1999]. The potential sources and relevance of potential emissions to air are shown in Table 3.11 and they are discussed later in this section.

Table 3.11: Significance of potential emissions to air from copper production process

Emission source	Dust and metal compounds	PCDD/F	Organic carbon	Sulphur compounds
Material handling	••	NR	NR	NR
Storage of raw materials	•••	NR	NR	NR
Drying	•••	•	•	•
Scrap treatment	••	••• (secondary)	••• (secondary)	NR
Smelting	•••	••• (secondary)	• (secondary)	••• (treated in a recovery plant)
Holding	•	NR	NR	NR
Converting	••	• (secondary)	• (secondary)	••• (treated in a recovery plant)
Refining	••	• (secondary)	• (secondary)	•
Melting/casting	• (•• for alloys)	•	• (secondary) + CO	NR
Ladle transfers	•••	NR	NR	•
Electrolysis	NR	NR	NR	NR
Slag treatment	••	NR	• CO (from electric furnace)	•
NB: ••• More significant – • Less significant. NR = Not relevant.				

Oxides of nitrogen are relatively insignificant [23, DFIU-University Karlsruhe 1996] but may be absorbed in the sulphuric acid produced from a primary process; the use of oxygen enrichment can sometimes reduce the formation of nitrogen oxides by the thermal route. This depends on the point where oxygen is added; sometimes a higher concentration of nitrogen oxides is produced due to the increase in temperature, however the gas volume and total quantity is lower. Low-NO_x burners can be used.

The formation of PCDD/F in the combustion zone and in the cooling part of the off-gas treatment system (de novo synthesis) may be possible. To safeguard against harmful effects on the environment, emissions must be reduced. Accordingly, off-gases have to be captured at their source of generation and routed to an off-gas cleaning device (e.g. a capture system followed by a dust collector and scrubber) [219, VDI 2007].

The emissions can escape the process either as stack emissions or as diffuse emissions, depending on the abatement systems used and the quality of plant maintenance. Stack emissions are normally monitored continuously or periodically and reported by on-site staff or off-site consultants to the competent authorities.

3.2.2.3.1 Carbon monoxide

In addition to the emissions outlined above, melting processes using furnaces that need to maintain a reducing atmosphere can produce a significant concentration of carbon monoxide. This is particularly the case for the melting of high-grade copper in shaft furnaces in combination with shape casting or the production of wire rod, as the products require controlled oxygen levels to obtain high conductivity. The process therefore operates under reducing

conditions and the carbon monoxide content of the gases may be elevated, with a typical level of approximately 5000 mg/Nm³. The burner control systems that are used can also minimise CO and maintain product quality. CO alarms can also be incorporated into the process. Typical CO production in a shaft furnace used for wire rod or semis production is 2000–11 000 g per tonne of copper [114, Eurometaux 1998]. In some installations, afterburning is used to remove hydrocarbons from the gases when scrap coated with organic matter is processed. CO is also destroyed at the same time and the emissions are reported to be ~ 45 g per tonne of copper [121, Rentz, O. et al. 1999].

It is possible to predict ground-level concentrations of CO and this may be used to determine the effect of CO on local air quality, so that further abatement needs can be assessed locally. CO elimination by combustion of the shaft furnace gases with these levels of CO would require additional fuel, and consequently the emissions of CO₂ would increase exponentially.

Carbon monoxide is also produced during the operation of the slag cleaning furnace and the blast furnace and in some circumstances can be emitted in the off-gases. Afterburning can be used to remove the CO, giving typical concentrations in the range of 10–200 mg/Nm³. There is at least one example of oxygen being lanced into the top of a blast furnace above the reaction zone to provide an afterburning zone in the furnace body. This measure also destroys organic compounds such as PCDD/F. The electric furnaces used for slag cleaning and reduction processes are normally operated with afterburning, either within the furnace or in a special reaction chamber.

3.2.2.3.2 Dust and metal compounds

These can be emitted from most stages of the process. The techniques for dealing with emissions from the handling, storage, drying and treatment stages are covered in Chapter 2 and the application of these techniques should be used to prevent and minimise these emissions.

Direct and diffuse dust emissions from the smelting, converting and refining stages are potentially high. The significance of the emissions is also high as these process stages are used to remove volatile metals such as Zn, Pb, some As and Cd from the copper and these metals are present in the gas and partly in the dust.

The primary smelters usually contain dust very well and are effectively sealed to minimise diffuse emissions; concentrate burners or lances are used and are therefore easier to seal. Good maintenance of the furnaces and ducts is practised to minimise diffuse emissions, and the collected gases are treated in dust removal systems prior to the sulphur recovery processes.

Secondary smelters are more prone to diffuse emissions during charging and tapping cycles. These furnaces have large charging doors and the warping and mis-sealing of these doors is a significant factor. In secondary bath smelters, the burden is charged via an enclosed charging system, and diffuse emissions occur at the taphole and runners and are captured by hoods and routed to the gas-cleaning system. The gases that are collected are usually cooled and dust is removed from gas streams by electrostatic precipitators or fabric filters. High filtration efficiency is usually achieved and dust concentrations after abatement are in the range of < 1–5 mg/Nm³ [157, Winter, B. et al. 1999] [206, Traulsen, H. 1999].

Because of the batch mode of operation, the conversion and fire refining stages cannot usually be sealed as well as in the smelting stage. The feeding and transfer of matte, slag and metal is a significant potential source of diffuse fumes. More importantly, the use of a ladle or boat transfer system can inhibit the effectiveness of fume collection hoods, particularly with the Peirce-Smith or a similar style of converter. To capture or reduce emissions occurring during charging or emptying, converters are either enclosed or provided with secondary capture hoods (see Chapter 2). The off-gas extracted from the enclosure or hood should be treated in a manner appropriate for the SO₂ content. Gases from matte conversion will have higher concentrations of

SO₂ and, in all cases, metal oxides (As, Pb, etc.) need to be removed. Through hoods, additions of flux and other material can minimise the roll-out time of converters and so reduce the time that converters are separated from the primary gas collection system. The production of higher grade matte reduces the number of ladle transfers and therefore reduces the potential for fumes. Diffuse or non-collected emissions are therefore very important. These issues are dependent on efficient primary and, in some cases, secondary fume collection.

Another source of dust and metals emissions, especially in primary copper production, derives from the treatment of the copper-rich slag. When furnaces are used, the waste gases from the process are routed to a flue-gas treatment system. Bag filters, ESPs and wet scrubbers are used. Emissions of dust concentrations after a bag filter or ESP are in the range of 1–5 mg/Nm³. The Atlantic Copper plant in Huelva (Spain), using a wet scrubber, has measured, with spot samples, dust emissions between 10 mg/Nm³ and 80 mg/Nm³ (with an yearly average of 40 mg/Nm³).

The fire refining process is also performed using furnaces and is common in primary and secondary copper production. Dust emissions are reduced usually using a bag filter. Dust emissions between < 1 mg/Nm³ and 5 mg/Nm³ have been reported. The Atlantic Copper plant in Huelva, using a combination of a wet scrubber and a wet ESP, has measured, with spot samples, dust emissions between < 5 mg/Nm³ and 20 mg/Nm³ (with an yearly average of 6 mg/Nm³).

A centralised secondary off-gas treatment system is used mainly by the primary copper production installation in order to optimise the performance of the abatement system. A bag filter is used for dust abatement and daily average dust emissions between < 1 mg/Nm³ and 5 mg/Nm³ are achieved. The Aurubis plant in Pirdop (Bulgaria), using a combination of a wet scrubber and a bag filter, has reported daily average emissions of dust between 2.5 mg/Nm³ and 23 mg/Nm³.

The melting and casting stages used during the production of wire rod, semis, etc. are also potential sources of dust and metals. The production of copper alloys, such as brasses, results in significant fumes (ZnO) at the casting stage and these require efficient collection. The dust burden is generally low but heat/energy can be recovered, if practicable. Efficient fume collection and fabric filters are usually used [114, Eurometaux 1998].

Emissions of metals are strongly dependent on the composition of the dust produced by the processes. The composition varies widely and is influenced by the process that is the source of dust and by the raw materials that are being processed. For example, the dust produced by a scrap converter is totally different to that of a matte converter and this will vary depending on the operating phase of the process (charging, blowing, casting, poling, etc.) at the time of the measurement, on the input material, etc. Table 3.12 and Table 3.13 show the percentage of metals in the dust from various processes and the measured ranges from a number of copper processes.

Table 3.12: Main constituents of dust from copper processes

Component	Concentrate to matte smelting furnace ESP dust	Blast furnace dust	Scrap converter dust	Matte converter ESP dust	Electric slag cleaning furnace dust	Anode furnace dust
Pb (%)	0.1–5	5–50	5–30	2–25	2–15	2–20
Zn (%)	0.1–10	20–60	25–70	5–70	25–60	5–40
Sn (%)	0.1–1	0.2–5	1–20	0.1–4	NR	NR
Cu (%)	5–30	2–12	2–15	10–25	0.5–2.5	15–25
As (%)	0.1–4	NR	NR	NR	NR	0.5–10
Ni (%)	0.1–1	0.1–1	NR	0.1–1	NR	NR

NB: NR = Not relevant.
Source: [206, Traulsen, H. 1999]

The variations between the individual measurements in a plant are greater than the differences between blast furnaces, electric furnaces, converters and anode furnaces. Typical ranges of measured concentrations downstream of a filtering separator of all copper-producing processes are shown in Table 3.13.

Table 3.13: Concentrations of dust constituents and PCDD/F in the clean gas of all unit processes from a secondary copper smelter

Gas constituents	Unit	Typical range in clean gas
Mercury (Hg)	mg/m ³	0.001–0.05
Thallium (Tl)	mg/m ³	< 0.02
Lead (Pb)	mg/m ³	0.04–1
Cobalt (Co)	mg/m ³	< 0.02
Nickel (Ni)	mg/m ³	0.01–0.1
Selenium (Se)	mg/m ³	0.01–0.1
Tellurium (Te)	mg/m ³	< 0.02
Antimony (Sb)	mg/m ³	< 0.01–0.1
Chromium (Cr)	mg/m ³	0.01–0.1
Cyanide (CN)	mg/m ³	< 0.05
Fluoride (F)	mg/m ³	< 0.05
Copper (Cu)	mg/m ³	0.02–1
Manganese (Mn)	mg/m ³	< 0.02
Vanadium (V)	mg/m ³	< 0.02
Tin (Sn)	mg/m ³	0.01–0.15
Arsenic (As)	mg/m ³	< 0.01–0.15
Cadmium (Cd)	mg/m ³	< 0.001–0.05
PCDD/F (total of dust-borne and gaseous fractions)	ng I-TEQ/m ³	0.01–0.4
<i>Source: [206, Traulsen, H. 1999]</i>		

3.2.2.3.3 Organic carbon compounds

Organic carbon compounds can be emitted during primary production from the drying stage depending on the materials used for ore treatment and the fuel used for drying. For secondary production, the most significant sources are from the scrap treatment, and smelting and refining stages. The conversion stage for secondary copper is also a potential source if scrap contaminated with organic material is added to the converter and complete combustion is not achieved; this is particularly the case for diffuse emissions. Organic carbon compounds can be emitted if oily material is used as feed and can account for 5–100 g per tonne of copper or between 1 mg/Nm³ and 10 mg/Nm³ [249, Austria, Brixlegg 2007]. VOCs may also be emitted from solvent degreasing or solvent extraction processes.

3.2.2.3.4 PCDD/F

The organic carbon compounds that can be emitted include PCDD/F, resulting from the poor combustion of oil and plastic in the feed material and from de novo synthesis if the gases are not cooled rapidly enough. Scrap treatment to remove organic contamination can be practised but usually afterburners are used to treat the gases produced, followed by rapid cooling. When it is not possible to treat the gases from the furnaces in an afterburner, they can be oxidised by adding oxygen above the melting zone. It is also possible to identify organic contamination of secondary raw materials so that the most appropriate furnace and abatement combination can be used to prevent the emission of smoke and fumes and the associated PCDD/F. Melting scrap

that is contaminated with organic material is also a potential source of PCDD/F in the semis industry [219, VDI 2007].

It has been reported that, in the case of primary smelting and converting, the high operating temperatures used destroy organic compounds and the presence of sulphur dioxide inhibits de novo synthesis of PCDD/F.

Chapter 2 describes some of the factors that influence the emissions of PCDD/F. The techniques used for the abatement of PCDD/F in this sector include afterburning, controlled gas handling and cooling, and effective dust removal; activated carbon adsorption is also used.

PCDD/F emissions of $< 0.001\text{--}0.1$ ng I-TEQ/m³ were measured downstream of a KRS, an electric furnace and two converters not equipped with secondary PCDD/F control devices. PCDD/F emissions measured downstream of an anode reverberatory furnace were of the order of 0.13 ng I-TEQ/m³ on average. Being designed as a countercurrent reactor, the blast furnace has relatively low off-gas temperatures, resulting in elevated PCDD/F emissions. Before the implementation of emission control measures, PCDD/F levels of between 2.3 ng I-TEQ/m³ and 29.5 ng I-TEQ/m³ were measured in blast furnace units. At a blast furnace with cold top gas, the dioxin emissions downstream of the afterburning chamber were reduced to < 0.2 ng I-TEQ/Nm³ by the application of carbon-lime additives [219, VDI 2007].

If large amounts of electronic scrap with brominated flame retardants are used as feedstocks, this may result in the formation of mixed halogenated dioxins. In the case of copper remelting/refining, the conditions may exist for the formation of PCDD/F, in particular when using scrap materials and chips contaminated with chlorine from the cutting fluids used.

3.2.2.3.5 Sulphur dioxide

The most significant sources of sulphur dioxide are the roasting, smelting and converting stages of primary copper production using sulphidic concentrates. Diffuse emissions are expected but can be collected in several ways [121, Rentz, O. et al. 1999]. Sulphur dioxide can also be emitted from the concentrate drying stage (mainly from the fuel used in the burner) and from the primary refining stages where the blister copper contains 0.03–0.1 % dissolved sulphur. The concentration in the gas is usually very low and simple scrubbing of the gases is generally used if required.

If not applying partial roasting and calcine smelting to matte in separate units because of special feed material, the roasting of copper concentrates is carried out simultaneously with smelting. The use of sealed furnaces for smelting allows the sulphur dioxide to be collected efficiently. All of the smelters in the EU-28 use oxygen enrichment, which produces a high sulphur dioxide concentration. This therefore allows the off-gas volumes to be minimised and the gas-handling systems including the sulphuric acid plants to be reduced in size. Very high levels of oxygen enrichment can increase the concentration of sulphur trioxide in the gases passing to an acid plant. This increased amount of sulphur trioxide in the gas from the furnace is absorbed in the scrubbers and increases the amount of weak acid for treatment, other uses or disposal. Contact sulphuric acid plants with four or five passes are used to convert the gases. In some cases, single contact plants are used if there is a low (< 5 %) sulphur dioxide content, otherwise double contact/double absorption plants are used [90, Traulsen, H. 1998]. If required, liquid sulphur dioxide can be produced from part of the sulphur dioxide contained in the gas.

In the case of copper concentrate with a low sulphur content and high organic carbon content, the smelting may be carried out in a shaft/blast furnace. In such cases, off-gases are incinerated in a local power plant as additional fuel. Flue-gases from the power plant are desulphurised.

The matte conversion stage also produces a significant concentration of sulphur dioxide. There are two potential problems when using batch-fed converters such as the Peirce-Smith or a similar style of converter. Firstly, gas collection is not totally efficient and the same remarks

apply as those made above in Section 3.2.2.3.2. Secondly, the sulphur dioxide concentration in the gases varies significantly depending on the stage of conversion and can cause problems with sulphur dioxide removal systems unless they are designed specifically to take account of this variation. These gases are mixed with the steady, more concentrated gases produced by the primary smelter to maintain autothermal operation of the sulphuric acid plant. Using several converters in a phased sequential operation combining the off-gases can also reduce this effect. Continuous processes such as the Mitsubishi process and the Kennecott-Outotec flash smelt/flash conversion process maintain a high and constant concentration of sulphur dioxide and do not need ladle transfers [66, George, D.B. et al. 1995], [72, Shibasaki, T. et al. 1993]. The gas volumes that are produced are consequently lower. This means that the concentration of sulphur dioxide is higher in the effluent gas but the mass is much smaller, at least during gas handling, cleaning and cooling. In the contact plant, the SO₂ to O₂ ratio should be adjusted and the SO₂ concentration is diluted down to the maximum tolerable concentration.

After heat recovery and cleaning of the gases, the sulphur dioxide in the gas from the smelting stages is converted to sulphur trioxide (SO₃). Sulphuric acid plants in the European copper industry have a reported conversion efficiency of 99.5 % to more than 99.9 % (excluding start-up, etc.) [90, Traulsen, H. 1998]. A very small amount of SO₃ is not absorbed and is emitted together with the residual SO₂ [121, Rentz, O. et al. 1999]. During start-up and shutdown there may be occasions when weak gases are emitted. These events need to be identified for individual installations and many companies have made significant improvements to the process control equipment to reduce these emissions. The height of the stack used for the acid plant gases usually takes these factors into account to reduce the local impact.

Sulphur dioxide may also be present in the gases produced during secondary smelting and converting stages and fire refining due to the sulphur content of the fuel or raw materials. In some cases, scrubbers (dry, semi-dry or wet) are used to remove the SO₂ and in one case the gases from an electric furnace (and a Cu/Pb converter) are diverted to a primary copper smelter sulphuric acid plant when certain raw materials are present.

Emissions of SO₂, after an abatement system, are in the range of 70–500 mg/Nm³ as a yearly average measured continuously. The Metallo-Chimique plant in Beerse (Belgium), using a bag filter with Sorbalit injection, has measured SO₂ emissions from the smelter between 0 mg/Nm³ and 1471 mg/Nm³ as an hourly average, and SO₂ emissions from the converter between 0 mg/Nm³ and 2765 mg/Nm³ as an hourly average.

3.2.2.3.6 Diffuse emissions

In pyrometallurgical plants, diffuse emissions may occur during both charging and tapping operations, as well as during the transfer of the molten products or intermediates from one operation to another. It is particularly important within this context that the prevailing temperatures of the various metal, slag or matte fractions are above the volatilisation points of the low-boiling accompanying metals (e.g. Zn, Pb and Sn) and their oxides, so that the latter accumulate in the furnace off-gas that is channelled and treated by the flue-gas treatment system. As far as possible, diffuse emissions should be captured at the source via secondary hoods and the extracted off-gas routed to the gas-cleaning system.

In secondary smelters with the low dust loads of the secondary hood off-gas, it is sometimes advantageous to combine this off-gas stream with the furnace off-gas prior to cleaning since this can improve the filtration properties of the total off-gas stream. Further diffuse emissions may occur during transport due to the resuspension of dust and the handling of the molten materials, in particular, during transfer or pouring operations. Moreover, dust emissions are generated during the handling and pretreatment of the secondary raw materials (e.g. size reduction, shredding, pelletising). The emissions at secondary copper smelters can be dominated by diffuse dust emissions which account for approximately 70 % of total emissions.[234, UBA (D) 2007].

3.2.2.3.7 Nitrogen oxides

The production stages for copper usually rely on high temperatures but are also associated with the use of oxygen. This reduces the partial pressure of nitrogen in the flame and reduces nitrogen oxide formation, provided that nitrogen is not present in great amounts in the very hot areas. Typical levels for the emissions of nitrogen oxides for secondary copper are reported to be in the range of 50–500 mg/Nm³, depending on the furnace and type of operation. For NO_x, the use of highly efficient processes (e.g. Contimelt) requires a balance to be established locally between energy use and achieved value.

Nitrogen oxides from primary processes are mainly absorbed in the sulphuric acid produced [130, Eurometaux 1998], (see also Table 2.17).

3.2.2.3.8 Summary of emissions to air

Emissions are summarised in Table 3.14, Table 3.15 and Table 3.16.

Table 3.14: Specific emissions to air from some primary and secondary processes

Process type	Dust (g/t of metal produced)	Sulphur dioxide (g/t of metal produced)	Cu (g/t of metal produced)	Pb (g/t of metal produced)	As (g/t of metal produced)
Primary Cu	130–800	6000–18 000	25–130	6–45	2–27
Secondary Cu	100–1000	500–3500	8–100	10–60	0.5–5
Melt shop semis fabrication	21	NA	4	NA	0.15
Wire rod production	10	NA	4	NA	0.05
NB: NA = Not applicable. Source: [234, UBA (D) 2007]					

Table 3.15: Achievable emissions from some secondary smelting and remelting/refining processes (with semis fabrication)

Parameter	CO	Dust	PM ₁₀	PM _{2.5}	NO _x	SO ₂	CO	SO _x	HCl	HF	Pb	Zn	Cu	O ₂	Sn	V	As	Hg	Ni	Cd	Temp.	Organic C	PCDD/PCDF
Units	mg/Nm ³													%	mg/Nm ³				°C	mg/Nm ³	ng I-TEQ		
Shaft furnace	< 0.1	0.5	0.53	0.39	45	0.2	< 0.1	NA	NA	NA	0.012	0.009	0.008	12	NA	NA	0.001	0.006	0.001	0.0001	199	1.2	0.3
Converter furnace	NA	0.75	NA	NA	7.3	NA	11.3	4.7	NA	NA	0.097	0.126	0.0334	17.8	NA	NA	0.0012	0.002 ₈	0.0033	0.0006	30	1.4	NA
Anode furnace	NA	2.3	1.5	1.02	179	24.5	NA	24.5	7.17	3.9	0.36	0.636	0.507	17.5	0.337	< 0.0005	NA	0.17	NA	0.0001	98	3.4	NA
Slag production unit	NA	< 0.3	NA	NA	NA	NA	NA	NA	NA	NA	NA	NA	NA	NA	NA	NA	NA	NA	NA	NA	NA	NA	NA
Asarco furnace	NA	0.5	0.25	0.25	21	17	NA	17	2.62	NA	NA	NA	0.0098	17.4	NA	NA	NA	NA	NA	NA	112	9.34	0.202
Thermal treatment of chips	NA	5	NA	NA	200	NA	NA	NA	NA	NA	NA	NA	NA	NA	NA	NA	NA	NA	NA	NA	NA	20	0.1
Electrically heated furnace	NA	5	NA	NA	NA	NA	NA	NA	NA	NA	NA	NA	NA	NA	NA	NA	NA	NA	NA	NA	NA	20	0.1
Rotary drum furnace	NA	5	NA	NA	300	NA	NA	NA	NA	NA	NA	NA	NA	NA	NA	NA	NA	NA	NA	NA	NA	50	0.1
Shaft furnace (Asarco)	NA	0.5–5	NA	NA	21–300	NA	NA	NA	NA	NA	NA	NA	NA	NA	NA	NA	NA	NA	NA	NA	NA	9–50	0.2–0.4
Milling (Plant B)	NA	< 10	NA	NA	NA	NA	NA	NA	NA	NA	NA	NA	NA	NA	NA	NA	NA	NA	NA	NA	NA	< 50	NA

NB: NA = Not available.
Source: [234, UBA (D) 2007], [249, Austria, Brixlegg 2007]

Table 3.16: Emissions and operating data from converters in secondary copper production

Operating parameter	Unit	Typical value or range	
		Scrap converter	Matte converter
Converter copper yield per batch	t	8–25	30–300
Number of batches per day		4–6	2–3
Batch duration	h	4–6	5–8
Blowing time/batch	h	2–3.5	4–7
Raw gas (including secondary hood off-gas)			
Volumetric off-gas flow	m ³ /h	80 000–150 000	80 000–150 000
Dust content	mg/m ³	10 000–30 000	10 000–30 000
Main dust constituents (depending on operating mode)			
Zn	wt-%	25–70	1–10
Sn	wt-%	1–20	1–5
Pb	wt-%	5–30	30–55
Clean gas (including secondary hood off-gas)			
Dust content ⁽¹⁾	mg/m ³	1–5	NA ⁽²⁾
SO ₂	mg/m ³	200–500 ⁽³⁾	NA ⁽²⁾
NO _x (expressed as NO ₂)	mg/m ³	20–30	NA ⁽²⁾
Off-gas temperature at stack outlet	°C	80–90	NA ⁽²⁾
⁽¹⁾ For dust constituents, see Table 3.10. ⁽²⁾ Matte converter off-gases are routed to the contact process unit for sulphuric acid production. ⁽³⁾ Continuous monitoring: daily mean value < 500 mg/m ³ ; max. half-hourly mean value < 1500 mg/m ³ . NB: NA = Not applicable. Source: [206, Traulsen, H. 1999], [234, UBA (D) 2007]			

3.2.2.4 Emissions to water

Pyrometallurgical processes use significant quantities of cooling water (cooling systems are covered in Chapter 2 and in a separate horizontal BREF on Industrial Cooling Systems [342, COM 2001]). Suspended solids, metal compounds and oils can be emitted to water from these sources. All waste water is treated to remove dissolved metals and solids. In a number of installations, cooling water and treated waste water including rainwater are reused or recycled within the processes but all sources should be treated separately as required [206, Traulsen, H. 1999], [234, UBA (D) 2007]. The potential sources and relevance of potential emissions to water are shown in Table 3.17 and discussed later in this section [219, VDI 2007].

Table 3.17: Significance of potential emissions to water from copper production processes

Emission Source	Suspended solids	Metal compounds	Oil
Surface drainage	•••	••	•••
Cooling water for direct cooling	•••	•••	•
Cooling water for indirect cooling	•	•	NR
Granulating water	•••	••	NR
Leaching (if not closed circuit)	•••	•••	•
Pickling	••	•••	•••
Tank house (if not closed circuit)	NR	•••	NR
Scrubbing systems	•••	•••	NR
NB: ••• More significant – • Less significant. NR = Not relevant. Open leaching circuits and open circuits in tank houses are not used in the EU-28.			

The ecotoxicology of metals in water is discussed in Annex 13.2.2 and a methodology for determining their impact is given in the MERAG report [301, MERAG 2007].

3.2.2.4.1 Suspended solids and metal compounds

These can be emitted from several stages of the process, the most significant being waste waters and rinses from pickling operations. The techniques for dealing with emissions from raw material handling and storage areas are covered in Chapter 2 and the application of these techniques is used to prevent or minimise these emissions. Surface water can result from either rainfall or from the wetting of stored material to prevent dust formation.

Potential sources of suspended solids and metal compounds are the cooling, granulating and leaching systems. In general, these systems are either sealed and the water is recirculated or they are non-contact.

Washing water, spent electrolyte and process effluents are also produced in the tank houses and pickling lines and by scrubbers. These effluents contain significant quantities of metal compounds in the solution and are treated along with liquid bled from the sealed cooling and granulating systems before discharge to water [27, M. Barry et al. 1993]. System leakage can occur and monitoring arrangements are needed for the pipework and storage tanks, specifically for pipelines outside the plant and in areas without a collection system. Waste water treatment processes are described in Chapter 2 and the methods used depend on the contaminants present, the destination of the treated water and the local environmental quality.

The amount of water discharged is also a significant issue as some installations use extensive water recirculation systems. One copper smelter reported that the discharge volume is 3000 m³/d, while similar plants that do not recirculate to the same extent discharge more than 100 000 m³/d. The mass emission of pollutants is therefore the factor that should be used. [234, UBA (D) 2007].

Waste water emissions are summarised in Table 3.18, Table 3.19, Table 3.20 and Table 3.21.

Table 3.18: Annual concentrations of the main constituents in the untreated waste water from a primary copper smelter

Source	Main components before treatment (mg/l)					
	Cu	Pb	As	Ni	Cd	Zn
Process water	2000	500	10 000	1000	500	1000
Precipitation water ⁽¹⁾	15–30	< 5	< 2	< 2	< 0.5	1–10
Direct cooling water	< 3	< 0.5	< 0.1	< 0.1	< 0.05	< 0.5

⁽¹⁾ Calculated from the analysis of the precipitation sludge and based on emission values which are accessible to the authority.
Source: [234, UBA (D) 2007]

Table 3.19: Example of the metal content in various waste waters after treatment

	Flow	Main components (mg/l)					
	(m ³ /yr)	Cu	Pb	As	Ni	Cd	Zn
Process water	180 000	0.01–0.2	0.001–0.04	0.01–0.1	0.004–0.15	0.0001–0.1	0.01–0.2
Surface run-off	700 000	0.01–0.4	0.005–0.2	0.003–0.07	0.002–0.4	0.0002–0.1	0.03–0.4
Direct cooling water	11 300 000	0.01–0.25	0.001–0.1	0.001–0.1	0.002–0.06	0.0001–0.003	0.02–0.5
Cooling water (total)	650 00 000	NR	NR	NR	NR	NR	NR

NB: Table refers to a combined primary/secondary copper smelter/refinery complex located on a river close to the sea producing 370 000 tonnes of Cu cathode per year. Metal concentrations (mg/l) are given as yearly averages.
NR = Not reported.
Source: [121, Rentz, O. et al. 1999]

In the example quoted above in Table 3.19, 20–50 kg of sludge per m³ of waste water arise, mainly depending on the arsenic content of the raw material, which varies from 5 % to 20 %, and on the iron content, which ranges from 25 % to 45 %.

Table 3.20: Overall pollutant rate of waste water discharges from two complex primary copper plants

Main components Overall pollutant rate (g/t)	Cu	Pb	As	Ni	Cd	Zn
Plant A producing Cu cathodes referred to above in Table 3.19	1–2.3	0.03–0.3	0.05–0.23	0.1–0.2	0.02–0.05	0.16–0.8
Plant B treating all waste water and surface water from historically polluted areas	5–10	0.3–1.0	2.5–5.0	5–10	0.1–0.3	2–5

Source: [238, ECI 2012]

Table 3.21: Annual loads discharged to water from a copper semis production plant

Substance	Value (kg/yr)
Cu	11
Ni	3
Zn	25
Pb	1
Cr	1
As	0.01
Cd	0.01
Hg	0.01
Sn	1

NB: Effluent discharge: 35 000 m³/yr.
Source: [121, Rentz, O. et al. 1999]

Sludges are produced in all of the processes and are usually sent for controlled disposal. In some cases, they are returned to the smelter to recover the metallic fraction.

3.2.2.4.2 Oil

Oil can be present on secondary raw materials and can be washed from the storage areas. The techniques used for storage are covered in Section 2.12.4.1. Waxes and oils are used in the coating and drawing processes associated with the production of rods and other shapes and their presence is taken into account to prevent contamination of water.

3.2.2.5 Process residues

Some intermediate products generated during copper production are classified as hazardous waste according to the Directive 2008/98/EC. Most of these materials, however, contain recoverable quantities of copper and other non-ferrous metals and are therefore used as raw materials in their own right. Depending on their characteristics and use, some copper residues could also be considered by-products, such as the final slag, according to REACH C1. Flue-dusts from all sources can also be reused in the smelting process and, to prevent dust formation during handling, they are carefully handled, usually in specially designed systems, or are already pretreated for the further processing requirements [219, VDI 2007]. Some furnace linings can also be reused as a taphole mass or in the process and may be incorporated in the slag. In other cases, the linings are disposed of. The sources of some residues and their potential uses are given in Table 3.22, Table 3.23 and Table 3.24.

Table 3.22: Residues from the production of copper

Process source	Residue	End use
Abatement systems	Filter dusts	Raw material for Cu (returned to smelter) Gypsum for sale Calcium source for smelter Pb, Zn and other metals
	Mercury compounds	Chemical industry
	Spent catalysts and acid	Neutralisation
	Sulphuric acid sludges Weak acid	Other uses, e.g. leaching decomposition For SO ₂
Smelter	Slag	To slag furnace or other separation Internal recycling
	Furnace linings	Recovery or disposal
Converter	Slag	To smelter - internal recycling
Slag furnace	Slag	Abrasive, construction material
Refining (anode) furnace	Slag	To smelter - internal recycling
Tank house	Electrolyte bleed	Ni salts or metal, Cu recovery, acid recovery
	Spent anodes	Other internal recycling: converter (cooling) or anode furnace
	Anode slime	Precious metals recovery
Melting/smelting	Skimmings and slag	Raw material for metal recovery
Slag flotation	Slag	Filler in cement production
Waste water treatment	Clean gypsum	Reuse in smelter as source of calcium
General	Oils	Oil recovery
Hydrometallurgy	Depleted electrolyte	Leaching
Semis production	Acid pickling solutions and rinses	Disposal as waste if low in non-ferrous metals or sold for metal recovery
Rod production	Acid pickling solutions (if applied)	Recovery in separate electrolytic cell
	Scale	Cu recovery
<i>Source: [130, Eurometaux 1998]</i>		

Table 3.23: Residues from primary and secondary smelting processes in Germany

Production step	Residue	Quantity (t/yr)	Use or treatment option
Primary smelting and electrolysis plant(460 000 t anodes/yr)			
Flash smelting furnace	Dust	100 000	Internal use at the flash smelting furnace
	Slag	700 000	Further processing in the electric furnace
Electric furnace (slag cleaning)	Dust	400	External use for Zn/Pb production
	Slag	700 000	External use as construction material
Copper converter	Dust	4000	Internal recycling to the flash smelter or electric furnace (secondary plant)
	Slag	160 000	Internal use at the flash smelting furnace
Anode furnace	Dust	200	Internal use at the flash smelting furnace
	Slag	20 000	Internal use at the copper converter
Electrolysis	Anode slime (wet)	3000	Recovery of precious metals and Se, Te, Pb
Sulphuric acid plant	Sulphuric acid	1 000 000	By-product for sale
	Final liquor	70 000	Internal use in the chemical plant for the production of nickel sulphate, As ₂ O ₃
Secondary smelting and electrolysis plant			
Electric furnace off-gas treatment	Dust	10 000	By-product for sale to recover Zn
	Slag	60 000	External use as construction material
Converter	Dust	400	Internal use at electric furnace
	Slag	15 000	Internal use at electric furnace
Contimelt process	Dust	1000	Internal use at the flash smelter/electric furnace
	Slag	2000	Internal use at the copper converter
Scrap converter/ TLA plant	Dust	1000	Further processing in the TLA plant
	Slag	2000	Internal use at the electric furnace
Process waste water treatment plant	Sludge	2000	Disposal as hazardous waste
General	Household refuse	500	
Secondary smelting and electrolysis plant			
KRS, off-gas treatment	Iron silicate slag	120–200	Construction material on disposal site
	KRS oxide	20–40	Sale
Mixed tin furnace	Mixed tin	50	Sale
Electrolysis	Anode slime	13	Sale
	Nickel sulphate	20	Sale
Waste water treatment	Precipitated sludge	NA	Disposal as hazardous waste
All steps	Anode remains	NA	Internal recirculation
NB: NA = Not applicable. TLA = Tin-lead alloy. Source: [234, UBA (D) 2007]			

Table 3.24: Residues from some remelting/refining processes (with semis fabrication)

Production step	Residue	Quantity (kg/t copper product)	Use or treatment option
Remelting/refining (with semis fabrication)			
Shaft furnace	Dross	NA	NA
	Flue-dust	0.7–1	To secondary copper production
	Refractory lining	0.5–1.5	Controlled disposal
	Sludge	2–4	Controlled disposal
	Production scrap	39	Internal recirculation
Induction furnace	Dross	8–15	Internal recirculation
	Flue-dust	4–7	To secondary copper production
	Refractory lining	2	Recovery of metals
	Copper mould	NA	NA
	Graphite mould	< 0.01	Recovery of graphite
NB: NA = Not applicable. Source: [206, Traulsen, H. 1999]			

Wastes destined for disposal are kept to a minimum and mainly consist of acid slimes from the sulphuric acid plants, which are treated and sent for disposal, or furnace linings, some of which cannot be recovered in the process. In some cases, tailings from the processing of smelter or converter slag by flotation are produced. These tailings are disposed of on site or at the mine site, if it is close by. Other wastes are either domestic or demolition wastes.

Table 3.25 and Table 3.26 show the potential use of the process residues. Many of the residues are used as raw materials for the production of other metals or are recycled within the copper production route [206, Traulsen, H. 1999].

Table 3.25: Potential uses and examples of the quantity of residues produced by a complex primary and secondary installation

Process unit	Residue	Amount (t/yr)	Use/treatment option
Primary plant: Annual cathode production: primary copper 220 000 t/yr			
Flash smelting furnace	Dust	100 000	Internal use at the flash smelting furnace
	Slag	400 000	Further processing in the electric furnace
Electric furnace	Dust	400	External use for Zn/Pb production
	Slag	400 000	External use as construction material
Copper converter	Dust	4000	Internal recycling to the flash smelter or electric furnace (sec. plant)
	Slag	150 000	Internal use at the flash smelting furnace
Anode furnace	Dust	200	Internal use at the flash smelting furnace
	Slag	20 000	Internal use at the copper converter
Sulphuric acid plant	Sulphuric acid	656 000	By-product for sale
Secondary plant: Annual cathode production: secondary copper 150 000 t/yr			
Electric furnace	Dust	10 000	By-product for sale to recover Zn
	Slag	40 000	External use as construction material
Converter	Dust	400	Internal use at the electric furnace
	Slag	10 000	Internal use at the electric furnace
Contimelt process	Dust	1000	Internal use at the flash smelter/electric furnace
	Slag	2000	Internal use at the copper converter
Scrap converter/TLA plant	Dust	1000	Further processing in TLA plant
	Slag	2000	Internal use at the electric furnace
Others			
Electrolysis	Anode slime (wet weight)	3000	Internal use at the chemical plant for the recovery of precious metals and Se, Te, Pb
	Final liquor	35 000 m ³	Internal use at the chemical plant for the production of nickel sulphate, As ₂ O ₃ , H ₂ SO ₄
Process waste water treatment plant	Sludge (wet weight)	1500	Disposal as hazardous waste
General	Household refuse	400	NA
NB: NA = Not applicable. TLA = Tin-lead alloy. Source: [121, Rentz, O. et al. 1999]			

Table 3.26: Potential uses and examples of the quantity of residues produced by a secondary installation

Process unit	Residue	Amount (t/yr)	Use/treatment option
Blast furnace	Slag	30 000–35 000	Sold as construction material
	Oxide from afterburning chamber, boiler and cooler	700–800	Internal use at the blast furnace
	Filter oxide	1000–1300	External use to recover Zn, Pb, etc.
Converters	Slag	17 000–19 000	Internal use at the blast furnace
	Oxide from afterburning chamber	250–300	Internal use at the blast furnace
	Oxide from cooler	100	Internal use at the blast furnace
	Residues	300	Internal use at the blast furnace
	Filter oxide	3500–3700	External use to recover Zn, Pb, etc.
Anode furnace	Anode copper residues	7000–8000	Internal use at the blast furnace
	Filter oxide	150	Internal use at the blast furnace
	Residues from furnace	200	Internal use at the blast furnace
Electrolysis	Anode slime	360	External use
	Nickel sulphate	700	External use
General	Household refuse	NA	NA

NB: Annual production 60 000 t/yr cathode.
NA = Not applicable.
Source: [121, Rentz, O. et al. 1999]

Slags contain varying amounts of copper and many are reused or treated to recover the metal content. Slag treatment is often carried out in a thermal process to produce an inert slag. The composition of some copper smelting slags before slag cleaning treatment is shown in Table 3.27.

Table 3.27: Composition of some copper smelting slags before slag cleaning treatment

Component	Flash furnace	Peirce-Smith converter	Combined slag after electric furnace slag cleaning
	(wt-%)		
Copper	1–2.5	3–5	0.3–0.8
Iron (total)	38–45	40–45	40–43
Silica	30–33	25	28–32
Magnetite	4–18	25	< 2

Source: [121, Rentz, O. et al. 1999]

Many of the slags produced by slag treatment processes contain very low levels of leachable metals and are stable. They are frequently sold as products for the abrasives and construction industries as they have excellent mechanical properties which are sometimes superior to those of competing natural minerals [206, Traulsen, H. 1999]. Oils from various sources within the process can be recovered.

3.2.2.6 Operating data from some copper production processes

Operating data for some copper processes are given in Table 3.28 to Table 3.37.

Table 3.28: Operating data for a copper electrorefining unit

Operating parameter	Unit	Typical value or range
Total power consumption	kWh/t copper cathode	360–380
Current density	A/m ²	320–350
Anode slime yield	kg/t copper cathode	5–12
Electrolyte temperature	°C	60–68
Yield	%	> 95
Anode scrap	%	10–12
Electrolyte composition		
H ₂ SO ₄	g/l	150–200
Cu	g/l	40–50
Ni	g/l	16–22
As	g/l	5–12
NB: Permanent cathode plates system. Source: [234, UBA (D) 2007]		

Table 3.29: Operating data for an electric furnace

Operating parameter	Unit	Typical value or range
Rated electric power	MWh	13.5
Coke consumption	kg/t burden	25–60
Smelting capacity	t/h	10–25
Raw gas (furnace)		
Volumetric off-gas flow	m ³ /h	15 000
Dust content	mg/m ³	Approximately 30 000
Main dust constituents (mean values)		
Cu	wt-%	0.3–6
Pb	wt-%	15–50
Zn	wt-%	10–50
Sn	wt-%	1–4
Off-gases with a SO ₂ content of > 500 mg/m ³ are subjected to wet scrubbing after dust collection and routed to a contact process, sulphuric acid production unit.		
Raw gas (secondary hoods)		
Volumetric off-gas flow	m ³ /h	150 000
Dust content	mg/m ³	< 5000
Main dust constituents mean values)		
Cu	wt-%	Approximately 8
Pb	wt-%	Approximately 27
Zn	wt-%	Approximately 8
As	wt-%	Approximately 1
Cd	wt-%	Approximately 1
Clean gas		
Dust content	mg/m ³	1–5
SO ₂ content	mg/m ³	< 500 ⁽¹⁾
Off-gas temperature downstream of filter	°C	< 85
⁽¹⁾ Continuous monitoring: daily average < 500 mg/m ³ ; max. half-hourly average < 1500 mg/m ³ . Source: [234, UBA (D) 2007]		

Table 3.30: Operating data for a KRS furnace

Operating parameter		Unit	Typical value or range
Burden throughput including iron		t/h	25–50
Fuel consumption (fuel oil)		kg/t burden	50–70
Reducing agent consumption (e.g. coke)		kg/t burden	Approximately 10
Yield	Iron silicate slag	kg/t burden	300–500
	Converter slag	kg/t burden	150–200
	Converter copper	kg/t burden	200–300
	KRS oxide (filter dust)	kg/t burden	50–100
Volumetric off-gas flow (furnace including secondary hoods)		m ³ /h	300 000
Raw gas dust content		mg/m ³	5000–10 000
Specific heat recovery rate		t steam GJ/t burden	0.6 (1.7)–0.7 (2.0)
Main filter dust constituents (depending on operating mode)			
Cu		wt-%	3–6
Pb		wt-%	15–20
Zn		wt-%	35–50
Sn		wt-%	2–4
Clean gas			
Dust content		mg/m ³	1–5
SO ₂		mg/m ³	50–500 ⁽¹⁾
NO _x (expressed as NO ₂)		mg/m ³	10–100
Off-gas temperature at stack outlet		°C	80–90
⁽¹⁾ Continuous monitoring: daily average < 500 mg/m ³ ; max. half-hourly average < 1500 mg/m ³ . Source: [234, UBA (D) 2007]			

Table 3.31: Operating data for an anode reverberatory furnace

Operating parameter		Unit	Typical value or range
Anode copper yield per batch		t	300–600
Number of batches per day			Approximately 1
Batch duration		h	22–27
Fuel consumption (fuel oil)		kg/t Cu	60–80
Reducing agent consumption	Pole gas	m ³ /t Cu	Approximately 10
	Pole wood	kg/t Cu	Approximately 20
Raw gas (including secondary hood off-gas)			
Volumetric off-gas flow		m ³ /h	100 000–150 000
Dust content		mg/m ³	Approximately 1000
Specific heat recovery rate		t steam GJ/t burden	0.5 (1.4)
Main dust constituents			
CaO (from off-gas conditioning)		wt-%	30–50
Cu		wt-%	15–25
Zn		wt-%	5–10
Sn		wt-%	1 - 3
Pb		wt-%	5 - 15
As		wt-%	0.5–5 ⁽¹⁾
Clean gas (including secondary hood off-gas)			
Dust content		mg/m ³	1–5
SO ₂		mg/m ³	150–500 ⁽²⁾
NO _x (expressed as NO ₂)		mg/m ³	100–350
Off-gas temperature at stack outlet		°C	Approximately 100
⁽¹⁾ Depending on the input material. ⁽²⁾ Continuous monitoring: daily average < 500 mg/m ³ ; max. half-hourly average < 1500 mg/m ³ . Source: [234, UBA (D) 2007]			

Table 3.32: Operating data for a rotary drum furnace

Plant data ⁽¹⁾	Unit	Range or typical value
Charge materials		Cathodes, wire bars, scrap materials, blister (in small quantities)
Capacity	t	35
Melting temperature	°C	1100
Melting capacity	t/h	4
Type of heating		Fuel-heated with natural gas
Specific energy consumption ⁽²⁾	MJ/t	Approximately 700 (60–70 m ³ natural gas)
Waste gas temperature (clean gas in the stack)	°C	80
Waste gas volumetric flow rate	m ³ /h	20 000
Waste gas cleaning method used		Quenchers, fabric filters
Total dust in the untreated gas	g/Nm ³	Up to 3
Emission data from recorded sources (clean gas, half-hourly averages)		
Total dust	mg/Nm ³	3
Dust constituents		
Nickel	mg/Nm ³	0.1
Cadmium	mg/Nm ³	0.04
Lead	mg/Nm ³	0.02
Copper	mg/Nm ³	4
Arsenic	mg/Nm ³	0.007
Total organic carbon (TOC)	mg/Nm ³	50
⁽¹⁾ The plant and emission data given are examples which represent the results of individual measurements.		
⁽²⁾ Including holding and realigning times.		
Source: [234, UBA (D) 2007]		

Table 3.33: Operating data for a shaft furnace of a continuous casting installation

Plant data ⁽¹⁾	Unit	Range or typical value
Charge materials		Cathodes, return scrap (internal and external scrap)
Capacity (theoretical)	t	50
Melting temperature	°C	1100
Melting capacity	t/h	25
Type of heating		Fuel-heated (natural gas)
Specific energy consumption ⁽²⁾	MJ/t	1300–1500
Waste gas temperature (cleaned gas)	°C	100
Waste gas volumetric flow rate	m ³ /h	40 000
Waste gas cleaning method used		Thermal afterburning, conditioning with lime injection and fabric filters
Total dust in the untreated gas	g/m ³	Up to 1.5
Emission data from recorded sources (clean gas, half-hourly averages)		
Total dust ⁽³⁾	mg/Nm ³	1
Dust constituents		
Nickel	mg/m ³	0.1
Cadmium	mg/m ³	0.05
Lead	mg/Nm ³	0.5
Cobalt	mg/Nm ³	< 0.1
Copper	mg/Nm ³	0.5
Arsenic	mg/Nm ³	0.05–0.15
CO	mg/Nm ³	9000 ⁽⁴⁾
Total organic carbon (TOC)	mg/Nm ³	50
⁽¹⁾ The plant and emission data given represent, by way of example, the results of individual measurements.		
⁽²⁾ Including holding and realigning times.		
⁽³⁾ Also using materials with organic impurities.		
⁽⁴⁾ The cathodes were melt-reductive.		
Source: [234, UBA (D) 2007]		

Table 3.34: Operating data for a shaft furnace of a cast-and-rolled wire installation

Plant data ⁽¹⁾	Unit	Range or typical value
Charge materials		Electrolytic copper (copper cathodes and own scrap)
Melting capacity	t/h	50–60
Type of heating		Fuel-heated (natural gas)
Specific energy consumption	MJ/t	1000–1050
Waste gas temperature (cleaned gas)	°C	120–160
Waste gas volumetric flow rate	m ³ /h	50 000–80 000
Emission data from recorded sources (clean gas, half-hourly averages)		
Total dust	mg/Nm ³	< 4
NO _x	mg/Nm ³	60–110
SO ₂	mg/Nm ³	15–30
HCl	mg/Nm ³	< 20
CO ⁽²⁾	mg/Nm ³	3500–9000 ⁽³⁾
Total organic carbon (TOC)	mg/Nm ³	10–21
⁽¹⁾ The plant and emission data given represent, by way of example, the results of individual measurements. ⁽²⁾ Without afterburning. ⁽³⁾ The cathodes were melt-reductive. Source: [234, UBA (D) 2007]		

Table 3.35: Operating data for crucible induction furnaces for the production of copper alloys

Plant data ⁽¹⁾	Unit	Range or typical value
Charge materials		Lumpy charge material, chips
Capacity (theoretical)	t	6–60
Capacity (utilised)	t	3–50
Melting temperature	°C	1050–1300
Melting capacity	t/h	2.4–25
Type of heating		Electrical
Specific energy consumption ⁽²⁾	MJ/t	900–1600
Waste gas temperature (clean gas in the stack)	°C	60–120
Waste gas volumetric flow rate	m ³ /h	17 000–70 000
Waste gas cleaning method used		Cyclone with downstream fabric filter
Total dust in the untreated gas	g/m ³	3 ⁽³⁾
Emission data from recorded sources (clean gas, half-hourly averages) ⁽³⁾		
Total dust	mg/m ³	< 5
Dust constituents		
Chromium	µg/m ³	< 10
Nickel	µg/m ³	< 10
Cadmium	µg/m ³	< 5
Lead	µg/m ³	< 20
Copper	µg/m ³	< 50
Manganese	µg/m ³	< 20
Tin	µg/m ³	< 20
Zinc	µg/m ³	< 100
Arsenic (gas phase)	µg/m ³	< 20
Total carbon (TOC)	mg/m ³	< 10–50
⁽¹⁾ The plant and emission data given represent, by way of example, the results of individual measurements. ⁽²⁾ Including holding and realigning times. ⁽³⁾ During production of brass. Source: [234, UBA (D) 2007]		

Table 3.36: Operating data for channel induction furnaces for the production of copper alloys

Plant data ⁽¹⁾	Unit	Range or typical value
Charge materials		Lumpy charge material, chips
Capacity (theoretical)	t	7–25
Capacity (utilised)	t	7–20
Melting temperature	°C	1050–1300
Melting capacity	t/h	2.5–8.8
Type of heating		Electrical
Specific energy consumption ⁽²⁾	MJ/t	1290
Waste gas temperature (cleaned gas)	°C	50–90
Waste gas volumetric flow rate	m ³ /h	10 000–20 000
Waste gas cleaning method used		Cyclone with fabric filter
Total dust in the untreated gas	g/m ³	3 ⁽³⁾
Emission data from recorded sources (clean gas, half-hourly averages) ⁽³⁾		
Total dust	mg/m ³	< 1
Dust constituents		
Chromium	µg/m ³	< 1
Nickel	µg/m ³	< 1
Cadmium	µg/m ³	< 0.1
Lead	µg/m ³	< 5
Copper	µg/m ³	< 10
Manganese	µg/m ³	< 1
Tin	µg/m ³	< 1
Arsenic (solid phase)	µg/m ³	< 0.1
Arsenic (gas phase)	µg/m ³	< 2
Total carbon (TOC)	mg/m ³	< 10
⁽¹⁾ The plant and emission data given represent, by way of example, the results of individual measurements. ⁽²⁾ Including holding and realigning times. ⁽³⁾ During production of low-alloy copper grades. Source: [234, UBA (D) 2007]		

Table 3.37: Operating data for a secondary copper process (remelting)

Inputs	Quantity	Outputs	Quantity
Metal	110 000 t/yr	Rolling products	125 600 t/yr
Master alloy	4000 t/yr	Extruded and drawn products	134 000 t/yr
Scrap	308 300 t/yr	Pipes	69 000 t/yr
Natural gas	538 kWh/t _{product}	Casting products	10.24 kg/t _{product}
Butane gas	34 kWh/t _{product}	Recycling of waste	69.83 kg/t _{product}
NH _x	12 220 m ³ /t _{product}	Disposal of waste	1306 t/yr
Nitrogen N ₂	15 834 m ³ /t _{product}	Sanitary sewage	0.14 m ³ /t _{product}
Hydrogen H ₂	1289 m ³ /t _{product}	Treated waste water	0.71 m ³ /t _{product}
Current	1117 kWh/t _{product}	Cooling water	26 699 m ³ /t _{product}
Water power	21 kWh/t _{product}	Evaporation	0.80 m ³ /t _{product}
Groundwater	28 229 m ³ /t _{product}	Cooling tower overflow	0.021 m ³ /t _{product}
Drinking water	0.145 m ³ /t _{product}	Carbon complete	25 416 kg/yr
Cover material	4.1 kg/t _{product}	Nitrogen oxide as NO ₂	63 072 kg/yr
Charcoal	0.85 kg/t _{product}	Dust	952 kg/yr
Technical gas ⁽¹⁾	17.8 m ³ /t _{product}	CO ₂ emission	0.12 t/t _{product}
Chemical solid	0.85 kg/t _{product}		
Chemical liquid ⁽²⁾	4.96 kg/t _{product}		
Processing liquids and fats ⁽³⁾	1.73 kg/t _{product}		
Butane gas ⁽⁴⁾	2.72 kg/t _{product}		
Petrol	0.04 l/t _{product}		
Diesel	2.42 l/t _{product}		

⁽¹⁾ Annealing inert gas.
⁽²⁾ Predominant as pickle and leach.
⁽³⁾ Oil, cooling lubricant, degreasing agent.
⁽⁴⁾ Process gas as an alternative to natural gas.
Source: [234, UBA (D) 2007]

3.3 Techniques to consider in the determination of BAT

The sections of this document entitled 'Techniques to consider in the determination of BAT' set out techniques generally considered to have the potential for achieving a high level of environmental protection in the industries within the scope of the document. The background to the way the techniques are described is given in Section 2.12 and Table 2.10.

This section presents a number of techniques for the prevention or reduction of emissions and residues as well as techniques for reducing the overall energy consumption. They are all commercially available. Examples are given in order to demonstrate techniques which illustrate a good environmental performance. The techniques that are given as examples are based on information provided by the industry, European Member States and the evaluation of the European IPPC Bureau. The general techniques described in Chapter 2 on common processes apply to a great extent to the processes in this sector and influence the manner in which the main and associated processes are controlled and operated.

3.3.1 Material reception, storage and handling processes

3.3.1.1 Techniques to reduce diffuse emissions from reception, storage and handling of primary and secondary materials

General techniques applied to reduce diffuse emissions from the reception, storage and handling of primary and secondary raw materials are considered in Chapter 2 (see Section 2.12.4.1) and in the Emissions from Storage BREF [[290, COM 2006](#)]

Description

The techniques to consider are:

- impermeable surface/floor with drainage collection for open stockpiles;
- extraction systems followed by a bag filter (see Section 2.12.5.1.4).

Technical description

Primary raw materials are ores, concentrates, coke, sand and other fluxes which are generally dusty in nature. A wide range of secondary raw materials that contain a number of metals and metal compounds are also used, such as scrap metal, skimmings/dross, slags, matte, and filter dust. These materials can range in size from fine dusts to large components, and may be contaminated by oils, acids and other organic matter. When dust-forming materials are handled, enclosed equipment/buildings and/or vented hoods are used to minimise the diffuse emissions (e.g. from static offloading and conveyor transfer points). A bag filter is normally used to abate dust and metals from the resulting flue-gas.

Open stockpiles are used for large, lumpy material but are usually situated on a hard impervious surface, such as concrete, with drainage collection to prevent soil/groundwater contamination from storage and handling.

Achieved environmental benefits

- Reduction of dust emissions.
- Reuse of dust in the process, if possible.

Environmental performance and operational data

At Aurubis Pirdop, the concentrates are stored in stockpiles in two covered buildings, with blending bins and bedding pits. Delivery and unloading by railway cars and trucks take place in a closed area.

At Aurubis Hamburg, enclosed conveyors transport the copper concentrates from the harbour to the storage buildings. Concentrates are stored in storage buildings. A flex-flap system is used to avoid diffuse emissions during the discharging of concentrate from the ship. The occurring dust is collected on the crane and dedusted in cassette filters. Fine dusts are stored in enclosed buildings, silos, or in sealed packaging. Before long-term storage in closed bays, they are pelletised and sometimes covered with lime milk. A new storage area (measuring 5000 m²) for bulk lead-containing materials with integrated crushing, screening and enclosed conveyor belts was constructed at the end of 2011. This also includes an exhaust system for the crusher, a sieve and belts and dedusting in a bag filter with a capacity of 70 000 Nm³/h. Large materials are stored outside, with water-spraying facilities for dust suppression.

At Aurubis Lünen and Olen, materials with harmful water-soluble or dispersible components are stored either in a covered storage area or in sealed packaging outside, in an open storage area. Windbreak walls and sprinkling facilities are used. For large materials such as scrap and blister, open storage is usual. If necessary, sprinkling facilities are used to avoid dust emissions. The covered storage area in closed halls at Aurubis Lünen is about 16 000 m². To reduce diffuse emissions from the remaining open storage areas, windbreak walls and sprinkling facilities are used.

At Atlantic Copper, a closed building for unloading concentrates, and a truck-washing station allow the particulate emissions to be minimised. The concentrates are transported from the harbour to the plant by covered trucks. Totally enclosed conveyor belts are used for material transportation. Bag filters in ventilation systems are used.

At Boliden Harjavalta, the concentrate is unloaded directly from the ship into the harbour transit terminal with grabs. Railway wagons are loaded in the terminal with front-end loaders. Transport from the port to the plant is by rail cars covered with hydraulic lids. Concentrates are unloaded and stored in a closed shed.

At Umicore Hoboken, a complex smelter with a wide variety of input raw materials, effective dust prevention at the source when handling primary and secondary products in the open air is realised by intensive sprinkling with fog cannons. Frequent sprinkling of stockpiles with fog cannons keeps the surface moist. The materials are stored within compartments with retaining walls on three sides, on sealed concrete floors, connected by a sewer system to a waste water treatment plant. Very dusty materials are stored inside closed buildings and are handled in closed systems. Trucks leaving the plant are cleaned in a wheel wash installation, and the water is treated in the on-site waste water treatment plant.

At KGHM, concentrates are transported in self-unloading railway carriages. From the dedicated unloading station, equipped with a dust-handling system, the concentrate is transported by means of belt conveyors to a covered blending station, which also functions as a concentrate storage and blending plant.

At Głogów 1, the air from the unloading facilities is filtered in a bag filter with a capacity of 190 000 Nm³/h. Discontinuous measurements of dusts are performed four times a year. Dust levels in the range of 2–5 mg/Nm³ are achieved. The covered storage capacity is about 35 000 tonnes.

At Legnica, the air from the unloading facilities is filtered in a bag filter with a capacity of 52 000 Nm³/h. Discontinuous measurements of dusts are performed four times a year. Dust levels in the range of 0.3–5 mg/Nm³ are achieved. The covered storage capacity is about 16 000 tonnes of materials.

At Głogów 1 and Legnica, the coke breeze is transported by rail, unloaded and stored in the coke bin. Black liquor, used as a binding agent in the concentrate briquetting process, is received in railway tank carriages and pumped to the storage vessels.

At Głogów 2, the air from the unloading facilities is filtered in a bag filter with a capacity of 80 000 Nm³/h. Discontinuous measurements of dusts are performed four times a year. Dust levels in the range of 1–5 mg/Nm³ are achieved. At the beginning of 2012, a new blending plant with a storage capacity of 60 000 tonnes came into operation. The auxiliary materials such as coke breeze, limestone, and sand are handled in a similar way to the concentrate, but on a separate line. The auxiliary material storage area is equipped with a dust-handling system. The air is filtered in bag filters with capacity of 3000 Nm³/h. Dust levels in the range of 1–5 mg/Nm³ are achieved.

At Metallo-Chimique Beerse, the dusty materials are stored in a closed building. Air suction is located on the roof. The air is filtered by a bag filter (120 000 Nm³/h). Dust emission levels of < 0.5 mg/Nm³ can be maintained. This value is based on two 4-hour measurements (spot sampling) in 2011. Other materials are stored outside on sealed concrete floors, connected by a sewer system with a waste water treatment plant. The material is kept moist by water (sprinkling, water cannons).

At Montanwerke Brixlegg, the feed materials are supplied by road or rail. Dusty materials are stored in boxes. The other feed materials are kept in an open storage area with a paved floor.

Cross-media effects

- Increase in energy use for the operation of exhaust and filtration systems, e.g. fans and bag filters.
- The treatment of flue-dusts to remove impurities has to be done internally.

Technical considerations relevant to applicability

Bag filters are generally applicable.

Economics

Metallo-Chimique (in 2007–2008) invested around EUR 6.5 million in a covered storage area for dusty materials. The storage area measures 8000 m² and 180 000 m³, with a maximum storage capacity of 20 000 tonnes. The maximum throughput of the hall is 50 000 t/yr.

Construction of a covered storage (area 5000 m²) with an integrated crushing, screening and conveying facility connected to a bag filter (70 000 Nm³/h) at Aurubis Hamburg involved a capital expenditure of EUR 7.5 million.

Construction of a covered storage hall for dust-forming input materials in Lünen with a surface area of 10 600 m² and a volume of 210 000 m³ involved a capital expenditure of EUR 7.5 million (including special ground construction with liquid-tight concrete, water spray nozzles, and tyre-washing installations for departing trucks).

Construction of a new covered blending plant with a storage capacity of 60 000 tonnes in KGHM Głogów 2 cost EUR 10 million.

Driving force for implementation

Reduction of diffuse emissions of metal-containing dust.

Example plants

Umicore Hoboken (BE), Aurubis (BE) and (DE), Metallo-Chimique Beerse (BE), Atlantic Copper (ES), Boliden Harjavalta (FI), KGHM Głogów 1, Głogów 2 and Legnica (PL).

Reference literature

[383, Copper subgroup 2012]

3.3.1.2 Techniques to reduce diffuse emissions from the transport of fine and dusty materials

General techniques applied to reduce diffuse emissions from the transport of fine and dusty materials are considered in Chapter 2 (see Section 2.12.4.1) and in the Emissions from Storage BREF [290, COM 2006]

Description

The technique to consider is extraction systems followed by a bag filter (see Section 2.12.5.1.4).

Technical description

Bag filter, see Section 2.12.5.1.4.

Achieved environmental benefits

- Reduction of dust emissions.
- Collected dust is reused in the smelting process.

Environmental performance and operational data

Continuous dust monitoring using dust impingement, optical or triboelectric devices is used to detect a filter bag failure. Pressure drop can be monitored to control the cleaning mechanism.

At Atlantic Copper Huelva, enclosed conveyor belts are used for material transportation. Bag filters in ventilation systems are used. A dried mix of concentrates and fluxes is lifted by two pneumatic systems to a bin with a 450-tonne capacity. Air from the pneumatic transfers is treated in a bag filter (flow rate of 1500 Nm³/h). Dust levels of < 7 mg/Nm³ are achieved.

At Aurubis Hamburg, the concentrate mixture and other feed materials are transported by an enclosed conveyor belt system from the storage building to a dosing bin station. The feed mix is transported to the dryers via an enclosed conveyor belt system. The dry feed leaving the dryers is transported by a dense phase pneumatic conveying system. The waste air of the lift is dedusted in a bag filter. Discontinuous dust measurements are carried out four times a year. Reported dust levels are < 5 mg/Nm³.

At Aurubis Pirdop, the dry feed leaving the dryers is transported by a pneumatic conveyor to the dry charge bin. The waste air of the lift is dedusted in the bag filter. Discontinuous measurements of dust are carried out once every six months.

At Boliden Harjavalta, the concentrate mixture is transferred in closed belt conveyors from the blending and storage to the dryers. The dried feed mixture is transported to the loss-in-weight feeding system (LIW), situated above the flash furnace, by pneumatic conveyors. The solid material is separated from the conveying air in the bag filter (flow rate 800–6 400 Nm³/h). Dust is measured discontinuously. Levels of < 5 mg/Nm³ are achieved.

At KGHM Głogów 1 and Legnica, the blended material is transferred via closed belt conveyors to a storage bin, metering bins, and screw mixers prior to the dryers. Black liquor is added in the screw mixers as a binding agent for the briquetting process. In Głogów 1 there are five briquetting lines, and in Legnica three, each with a capacity of 60 t/h. Bag filters are installed for the concentrate unloading facility, briquetting machines, and transport lines. Discontinuous measurements of dust are performed four times a year.

In Głogów 1, transport lines have the following:

- Ventilation system for concentrate-conveying chute areas equipped with four bag filters (10 000 Nm³/h each). Dust levels in the range of 3–10 mg/Nm³ are achieved.
- Ventilation system for the briquette-conveying transfer station equipped with a bag filter (25 000 Nm³/h). Dust levels in the range of 3–5 mg/Nm³ are achieved.

- Ventilation system for briquette transfer storage bins (two in operation) consisting of three bag filters (25 000 Nm³/h each) for the air from the top of the bins and three bag filters (27 000 Nm³/h each) for the air from their bottom vibrators. Dust levels in the range of 3–5 mg/Nm³ are achieved.

In Legnica, transport lines have the following:

- Ventilation system for concentrate conveying system, equipped with a bag filter (10 000 Nm³/h, dust 0.2–5 mg/Nm³).
- Ventilation system for briquette transfer storage bins equipped with a bag filter (9 000 Nm³/h, dust 0.3–5 mg/Nm³).
- Ventilation system for the briquetted concentrate and auxiliary materials conveying system equipped with a bag filter (23 500 Nm³/h, dust 0.3–5 mg/Nm³).
- Ventilation system for the briquetted concentrate and auxiliary materials conveying system (to each furnace) equipped with three bag filters (20 000 Nm³/h each, dust 2–10 mg/Nm³).

The bag filters in Głogów 1 and Legnica are of the pulsatory cassette type.

In Głogów 2, blended material is transferred via a closed belt conveyor to a dryer, from where it is then pneumatically transported to the charging bins.

At Metallo-Chimique Beerse, pneumatic transport is used for fine and dusty materials through double-walled pipes to feed the smelter. The fine and dusty materials are the input materials which are dried and temporarily stored in a silo before being sent to the smelter.

At Umicore Hoboken, dusty materials are stored in containers in closed buildings. They are emptied in a closed system and then transported by a closed conveyor system to a mixer, where they are mixed with either very wet materials or water, before being stored in the open air. The closed system is put under negative pressure, and the air which is expelled from the system is cleaned in a bag filter.

Cross-media effects

- Increase in energy use for the operation of exhaust and filtration systems, e.g. for fans and bag filters.
- The treatment of flue-dusts to remove impurities has to be done internally.

Technical considerations relevant to applicability

Generally applicable.

Economics

No information provided.

Driving force for implementation

- Reduction of emissions.
- Raw material savings.

Example plants

Atlantic Copper Huelva (ES), Aurubis Hamburg (DE), Aurubis Pirdop (BG), Boliden Harjavalta (FI), KGHM Głogów 1, Głogów 2 and Legnica (PL), Metallo-Chimique Beerse (BE), and Umicore (BE).

Reference literature

[238, ECI 2012], [383, Copper subgroup 2012]

3.3.2 Material pretreatment processes

3.3.2.1 Techniques to prevent and reduce emissions from the pretreatment of primary and secondary materials such as blending, drying, mixing, homogenisation, screening and pelletisation

Ores, concentrates and a variety of secondary raw materials are used for copper production, ranging from fine dusts to large single items. The copper content varies for each type of material, as does the content of other metals and contaminants.

The main pretreatment techniques applied are blending, drying (for concentrate drying, see Section 3.3.2.3), briquetting/pelletising/agglomeration and size reduction and separation.

Blending is performed to mix ores or concentrates of varying quality with fluxes or to mix different secondary raw materials, to produce a stable and homogeneous feed. Blends are produced using bedding plants or dosing bin systems using loss-in-weight dosing systems or belt weighers.

Drying is used if the smelting process requires a dry feed, or a reduction in feed humidity. It is achieved by the application of hot gas rotary dryers (directly heated by a burner) or steam coil dryers (indirectly heated using steam or hot air in heat exchanger coils). Steam coil dryers may use waste heat from other parts of the process provided that the heat balance allows it. For special materials like flue-dust, residues, sludges and others, hot air conveyors or vacuum dryers can be used.

Depending on the process, concentrates and other fine materials can be pelletised or compressed in briquettes. Coating and binding agents are used for this purpose, to reduce dust development in subsequent process steps. Scraps are compacted by pressing or balling, prior to processing.

Crushing, size reduction and screening are practised to reduce the size of secondary raw material to make it suitable for sale or further processing.

Description

The techniques to consider are:

- enclosed conveyors and hood or pneumatic transfer system (see Section 2.12.4.1);
- enclosed building (see Section 2.12.4.1) to carry out activities with dusty materials (e.g. mixing);
- dust suppression systems such as water sprays or fog systems;
- dust and gas extraction systems connected to the filtration equipment, such as a bag filter (see Section 2.12.5.1.4);
- water cannons, to keep material moist for mixing performed outside;
- collection and treatment of liquid effluents prior to discharge;
- scrap separation techniques to increase the metal recovery yield.

Technical description

Techniques used for pretreatment depend on the material size and nature, and the extent of any contamination.

When dusty materials are to be blended, the blending takes place in enclosed buildings, and enclosed conveyors and pneumatic transfer systems are used. Extraction systems and subsequent dedusting can also be applied. Collected dusts can be returned to the process. Dust suppression systems such as water sprays or fog systems can be applied to give fine water mists. Concentrates naturally contain sufficient water to prevent dust formation.

The dried material is usually very dusty, and pneumatic transport is used, with extraction and bag filters used to treat dusty gases. Collected dusts are returned to the process.

The briquetting and pelletising areas are encapsulated and covered. Enclosed conveyors are used. Ventilation systems are applied with subsequent dedusting in the bag filter. Scrap compacting operations take place in an enclosed building or in an open area equipped with dust suppression systems. Noise reduction measures may be necessary, such as a noise reduction wall.

Crushing, milling, grinding and screening operations are potentially a source of dust emissions, and so extraction and abatement systems are used and the collected dusts are returned to the process. Dust suppression systems, such as water sprays or fog systems, can be applied.

Separation techniques are used for secondary raw materials, in a dedicated process, if necessary and if suitable for the recovery process. Manual and mechanical separation are used to pretreat streams, e.g. for the removal of batteries, mercury contacts, and cable insulation from electronic equipment. Electronic components may be ground in shredders or mills to liberate the circuit boards and other metallic components from the non-metallic ones so that separation can take place. The density and size difference of the various fractions are used to separate metallic and non-metallic compounds using a water carrier. Air classification is also used to separate metals from less dense materials from electronic scrap. Magnetic separation is used to remove pieces of iron, generally by the use of overband magnets above conveyors. Optical separation or eddy current separation by electromagnetic fields can be used to separate aluminium from other material. Induction separation can be used to separate plastics.

Achieved environmental benefits

- Prevention and reduction of dust, metals and other compounds emissions.
- Preservation of raw materials, as filter dust is reused in the process.
- Reduction of emissions to water.

Environmental performance and operational data

At the Atlantic Copper plant in Huelva (ES), the preparation of the blend is carried out in 16 silos, each with a 200-tonne capacity, two of which are used for the fluxes. Conveyor belts, located inside closed galleries, transfer the concentrates and fluxes from the covered storage to the silos; ventilation hoods at each transfer point and bag filters for vent gas dedusting are installed.

At the Aurubis plant in Hamburg (DE), the copper concentrates and other feed materials for the primary smelter are transported by a conveyor belt system (300 t/h) from the storage building to a dosing bin station, with six bins, each with a 240-tonne capacity for concentrate and one bin with a 220-tonne capacity for silica flux. The bin station allows the components of the feed mix to be adjusted by speed-controlled bin extraction belts. The feed mix is transported to the dryers via an enclosed conveyor belt system. A ventilation system is in use at the concentrate reception and weighing bins, with dedusting in a bag filter.

A covered storage area bulks secondary materials with integrated crushing, screening and enclosed conveyor belts. Fine and sludge-type feed materials for the secondary smelter are pelletised and dried to less than 2 % with hot air on a conveyor-type or a vacuum dryer. The pelletising area is encapsulated and covered. Closed conveyors are used. Exhaust gases are directed to a bag filter. Gas, after drying, is treated in a bag filter. Continuous dust measurement indicates dust levels of 0.5–10 mg/Nm³ (half-hourly average), 0.5–5 mg/Nm³ (daily average) and a yearly average value of 3.4 mg/Nm³.

At the Aurubis plant in Pirdop (BG), the preparation of the blend is carried out automatically. Weight feeders extract defined material quantities from each feed bin, which are then discharged onto a belt conveyor. The mix obtained on the conveyor is screened and conveyed to the four 'wet blend' bins. Blending activities take place in an enclosed building. The blend is transported in enclosed conveyors to the charge bins.

At the Aurubis plant in Lünen (DE), the preparation of electronic scrap is designed for a good separation. Electronic scrap is shredded and then passed through air separation, screening, magnetic separation for iron, optical separation for aluminium and some alloys, and induction separation for plastic material. Shredding and separation take place in an enclosed building. Sieves, as well as transfer points from one conveyor belt to another, are closed. Sprinkling facilities to keep the material wet are also installed. Conveyors for shredded material are vented and the exhaust gas is treated in a bag filter. The air from the air separation column is treated in a cyclone. Dusty materials are stored and blended in an enclosed building. A partial agglomeration of material with water is carried out before charging to the KRS furnace. Closed conveyors are used.

At the Boliden plant in Harjavalta (FI), a feed mixture of different concentrates is prepared in the homogenisation bedding plant. In addition, silica flux and different recycled precipitates and other secondary materials are mixed during homogenisation. The homogenisation process of the feed mixture improves the process controls. The bedding plant is located in a closed shed. Homogenised feed mixture is transferred using belt conveyors to bins. After screening, the feed mixture goes to the drying facility on covered belt conveyors. The same system is used at Boliden Rönnskär (SE).

At the KGHM Głogów 1 plant (PL), blending is performed in a bedding plant. The concentrates and returns are distributed in even layers in one of the three aisles. Aisle-emptying is done with a blending machine which cuts across the concentrate layers and thus collects blended material, sending it via belt conveyors to a storage bin. From the storage bin, the concentrate blend is distributed to the metering bins of the drying lines. The blend is fed to screw mixers where black liquor is added. In Głogów 1, there are five briquetting lines, each with a capacity of 60 t/h. A bag filter is installed for the concentrate unloading facility, briquetting machines, and for the transport lines (described in Section 3.3.1.2). The filtered ventilation air from the briquetting areas contains dust at a level of 0.3–5 mg/Nm³.

At the KGHM Głogów 2 plant (PL), three bag filters dedust the ventilation air from the concentrate unloading station. The copper concentrate and other feed materials for the primary smelters are transported by a conveyor belt system from the unloading station to the closing bin station with 15 bins for concentrate and 6 bins for other materials. The speed-controlled belts receiving concentrate from the bins enable the desired blend to be maintained.

At the KGHM Legnica plant (PL), concentrate blending is carried out automatically. Materials from each bin are discharged onto the conveyor belt with a weighing system, allowing the desired blend to be obtained. This is then fed to the screw mixer where black liquor is added.

At the Metallo-Chimique plant in Belgium, a natural-gas-heated rotating dryer is installed for drying secondary raw materials (see Figure 3.12 and Table 3.38).

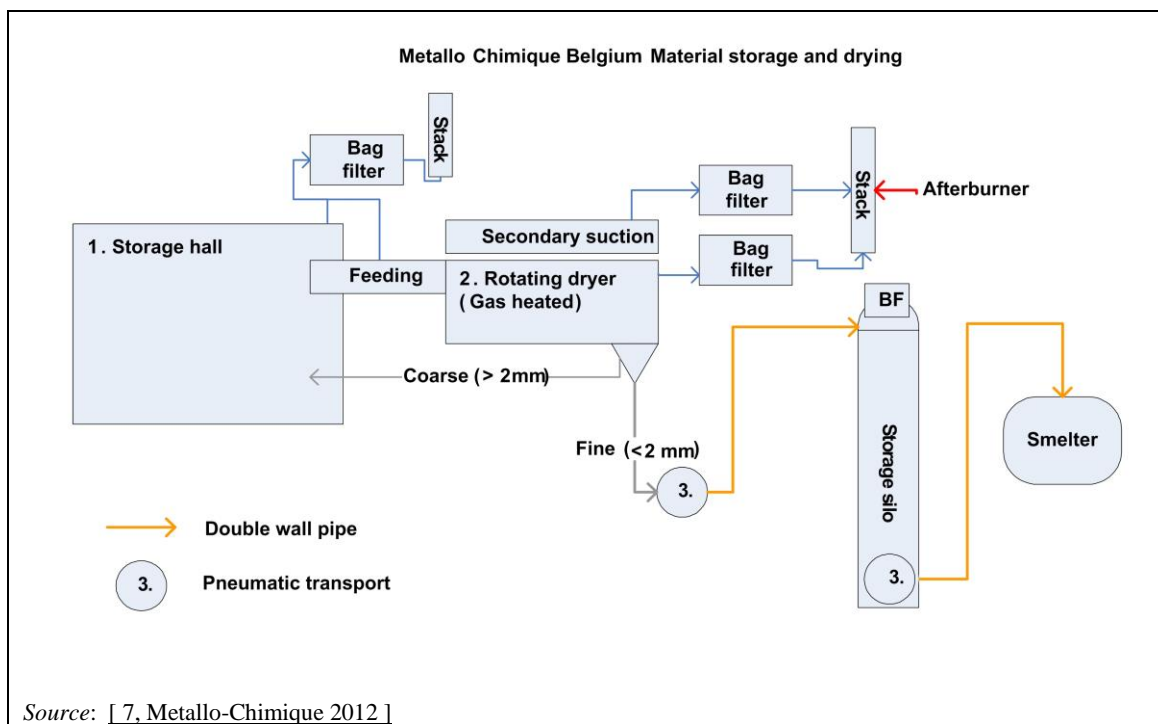

Figure 3.12: Metallo-Chimique – Material storage and drying

The bag filter works when the dryer is in operation.

Table 3.38: Operational data for Metallo-Chimique dryers

Furnace type	Capacity	Heating	Off-gas treatment	Emissions
Rotating dryer	15 t/h (2 tonnes water/hour; water content: before 12 %, after < 1 %)	Combustion of natural gas	Primary bag filter + Secondary bag filter + Afterburner	Dust 1–3 mg/Nm ³

Source: [7, Metallo-Chimique 2012]

Some forms of scrap are baled by means of hydraulic balers; others are cut into manageable pieces using scrap shears. If necessary, slag is broken into smaller fragments.

At the Umicore plant in Hoboken (BE), electronic scrap is shredded for sampling and for introduction into the furnace. The shredding operations and the conveyor belts are put under negative pressure; the exhaust air is treated in an absolute filter (bag filter). The absolute filter is a multiple filter with elements placed in series. The flow rate through the filter is not very high and emissions are classified as insignificant and consequently are not measured. The shredded material is sprinkled with water during the unloading of the conveyor belt. The feed for the furnace is blended in beds in the open air, with the dust-sensitive materials being moistened first. Blending is done by front-end loaders.

Cross-media effects

Dust suppression systems

- Increase in energy use for the smelting operation due to the increased water content of raw materials.
- Increase in water use.
- Water treatment is needed for the run-off water.

Dust and gas extraction systems connected to the filtration equipment

- Increase in energy use.
- Waste could be produced if the abated dust is not reused.

Afterburner with quenching and dust filtration system

- Increase in energy use and in NO_x emissions.

Collection and treatment of liquid effluents prior to discharge.

- Increase in energy use and in the use of additives for the treatment of the waste water.

Technical considerations relevant to applicability

- An enclosed building, enclosed conveyor, pneumatic transfer system and extraction system connected to the filtration equipment are applied for dust-forming materials.
- Dust suppression systems are applicable only when the smelter and the subsequent abatement system can process wet raw materials.
- Bag filters can only be used if the temperature of the gases is higher than the dew point.

Economics

In 2007–2008, Metallo-Chimique replaced an existing bag filter for waste gases from the dryer with a new bag filter (19 500 Nm³/h). This involved an investment of EUR 665 000 (for a bag filter with an afterburner in the chimney and for the chimney itself). The secondary filter (20 500 Nm³/h) was installed in 1994–1995, for an investment of EUR 400 000.

The construction of a covered storage area (5000 m²) with an integrated crushing, screening and conveying facility connected to a bag filter (70 000 Nm³/h) in Aurubis Hamburg involved a capital expenditure of EUR 7.5 million.

The construction of a covered storage hall for dust-forming input materials in Lünen with a surface area of 10 600 m² and a volume of 210 000 m³ involved a capital expenditure of EUR 7.5 million (including special ground construction with liquid-tight concrete, and an application of water spray nozzles and tyre washing for departing trucks).

The construction of a noise-reducing wall in Olen involved an investment of EUR 560 000 (the part of the walls along the Watertorenstraat: length: 100 metres, height: 4 metres; length: 132.3 metres, height: 11 metres; and the part at right angles to the Watertorenstraat: length: 38.31 metres, height: 11 metres).

Driving force for implementation

- Prevention and reduction of diffuse emissions and recovery of raw materials.
- Optimisation of the smelting process.
- Environmental and health regulation requirements.

Example plants

Atlantic Copper Huelva (ES), Aurubis Hamburg (DE), Aurubis Pirdop (BG), Boliden Harjavalta (FI), Boliden Rönnskär (SE), KGHM Głogów 1, Głogów 2 and Legnica (PL), Metallo-Chimique Beerse (BE), and Elmet S.A. Berango (ES).

Reference literature

[238, ECI 2012], [383, Copper subgroup 2012]

3.3.2.2 Techniques to remove oil from turnings before the melting stage in secondary copper production

In plants where turnings from mechanical operations are used as secondary raw material, de-oiling operations are applied to remove oil and oil emulsion from the turnings before melting. The application of the de-oiling operations and the technique used depend on the degree of contamination (e.g. if the turnings producer has already removed the auxiliary material - oil or oil emulsion - for recycling, it is not necessary to carry out the de-oiling operation before the melting process).

Description

The techniques to consider are:

- centrifugation with oil recovery;
- pyrolytic treatment using a rotary dryer;
- washing with detergents followed by centrifugation and drying at a temperature of 130–140°C.

Technical description

Centrifugation with oil recovery

Highly contaminated turnings can be centrifuged to remove most of the oil. The separated oil has to be separated from the water to be reused.

Pyrolytic treatment using a rotary dryer

Indirect heating of the turnings is used. The temperature is controlled at 500 °C so that pyrolysis takes place. The pyrolysis gases from the dryer are combusted at 850 °C in an afterburner to achieve complete combustion, then quenched to avoid PCDD/F de novo synthesis and treated in a wet scrubber or in a bag filter.

Washing with detergents followed by centrifugation and drying

To remove the oil, the turnings can be washed with water and detergent. Then the turnings are dried first with centrifugation and then in a dryer at a temperature of 130–140 °C.

Achieved environmental benefits

- Removal of oil and organic compounds from the turnings before the melting stage.
- Reduction of emissions from the smelting (especially organic compounds).

Environmental performance and operational data

Dust in the waste gas is removed by a bag filter and, based on periodic measurements, emissions of 0.01 mg/Nm³ to 8.6 mg/Nm³ are reported.

Organic compounds (such as VOCs) are reduced by an afterburner and, based on periodic measurements, emissions of 1 mg/Nm³ to 5 mg/Nm³ are reported.

PCDD/F emissions of 0.027 ng/Nm³ to 0.455 ng/Nm³ are reported, based on periodic measurements.

Table 3.39 shows the emissions data for pyrolytic treatment in four plants in Italy in 2010.

Table 3.39: Emissions from four turnings dryers in 2010

Plant	Technique	Pollutant	Unit	Values			Monitoring frequency	Average
				Min.	Avg.	Max.		
A	Afterburner + bag filter	Dust	mg/Nm ³	0.144	1.09	2.1	Continuous	Monthly
		PCDD/F	ng/Nm ³	0.144	0.261	0.455	Periodic (3 times a year)	Over the sampling period
		CO	mg/Nm ³	0.1	0.36	0.9	Continuous	Monthly
		NO ₂	mg/Nm ³	3	15.9	28.8	Periodic (twice a year)	Over the sampling period
B	Afterburner + bag filter	Dust	mg/Nm ³	NR	8.62	NR	Periodic (once a year)	NR
		NO ₂	mg/Nm ³	NR	12.33	NR		
		VOC	mg/Nm ³	NR	2.9	NR		
C	Afterburner + bag filter	Dust	mg/Nm ³	0.01	0.22	0.61	Periodic (3 times a year)	Over the sampling period
		PCDD/F	ng/Nm ³	0.1889	0.239	0.291	Periodic (twice a year)	
		CO	mg/Nm ³	1	1.3	2	Periodic (3 times a year)	
		NO ₂	mg/Nm ³	6	11.3	16		
		VOC	mg/Nm ³	1	2	3		
D	Afterburner + bag filter	Dust	mg/Nm ³	NR	0.58	NR	Periodic (once a year)	Over the sampling period
		PCDD/F	ng/Nm ³	NR	0.0272	NR		
		NO ₂	mg/Nm ³	NR	36	NR		
		VOC	mg/Nm ³	NR	5	NR		

NB: NR = Not reported.

Source: [384, Italy 2013]

Cross-media effects

- Increase in energy use.
- Increased emissions of CO₂ and NO_x.
- Increase in waste water.

Technical considerations relevant to applicability

Generally applicable, unless the furnace and abatement system are specifically designed to accommodate the organic content.

Economics

No information provided.

Driving force for implementation

Reduction of the VOCs emitted from the smelter.

Example plants

Four plants in Italy.

Reference literature

[384, Italy 2013] [383, Copper subgroup 2012]

3.3.2.3 Techniques to reduce emissions from concentrate drying

Concentrates are dried to reduce the moisture content from 7–8 % to about 0.2 % prior to the smelting process. For smelting in shaft furnaces, the concentrate is dried to 3.5–4 % and briquetted.

There are two types of dryers used for drying copper concentrates.

- Hot gas rotary dryers, heated by off-gases from natural gas combustion or by other fuels. Process gas from furnaces, such as the anode furnace, can also be used.
- Steam-heated coil dryers, i.e. dryers using mainly steam from the waste heat boiler.

For dryer descriptions, see Section 2.5.1.2.

Due to the dried concentrate being typically very dusty, extraction and abatement systems are used to collect and reduce the dusty gases emission.

Description

The techniques to consider are:

- bag filter;
- electrostatic precipitator (ESP);
- scrubber.

Technical description

Depending on the type of dryer, off-gases may contain SO₂ due to oxidation of the material. This is only relevant for directly heated dryers, as when indirect steam coil dryers are used the temperature is low enough to avoid ignition of the concentrate and thus SO₂ cannot be formed.

The rotary dryer is a rotating drum. The hot gas produced by the combustion of natural gas is placed in contact with the wet concentrate and the water contained is transferred to the gas. The gas leaving the dryers is treated for dust removal in a bag filter, electrostatic precipitator or scrubber. A scrubber is used for the abatement of SO₂. N₂ or another inert gas could be used to avoid the ignition of the concentrate.

Steam dryers are indirectly heated via steam coils. The throughput depends on the steam pressure and retention time; by increasing the pressure, the capacity can be increased. A small amount of carrier air is introduced to pick up the water of the concentrate. Steam coil dryers can use waste heat from other parts of the process, provided that the heat balance allows it. The air is treated for dust removal in a bag filter.

Dried ores and concentrates can be pyrophoric and the design of the abatement system takes this into account. Inert gas (nitrogen) or the low residual oxygen in combustion gases can be used to suppress ignition.

Achieved environmental benefits

Bag filter and ESP

- Reduction of dust and metals emissions.
- Recovery of raw materials, as collected dust is reused in the process.

Scrubber

- Reduction of SO₂ emissions.
- Reduction of dust emissions when the Venturi scrubber is used.

Environmental performance and operational data

Drying of concentrates produces a significant amount of very fine particles. Due to the presence of aerosols and variations in temperature, condensation and settlement of dust in the pipes can take place. These deposits are removed by the flue-gas itself or by pressurised air.

Table 3.40 below shows the performance and operational data from some primary copper producers. Data represent long-term normal operation under different conditions, such as variability of input material, various loads and operating regimes, abrasion of equipment, and wearing of filter elements.

Table 3.40: Operational and performance data for concentrate drying (part 1)

Plant	Atlantic Copper		Aurubis Hamburg		Aurubis Pirdop	
Dryer type	Rotary dryer	Steam dryer	Rotary dryer	2 steam dryers	Steam dryer	Steam dryer
Dryer capacity	100 t/h charge	70 t/h charge	100 t/h charge	50/100 t/h charge	110 t/h charge	
Dryer heating	Combustion of natural gas. Mixing of combustion gases with nitrogen (in part from elevation system)	Steam pressure, 4.5–18 bar	Combustion of natural gas. Mixing of combustion gases with steam superheater gas and nitrogen	Steam pressure, normally 11 bar	Steam pressure, normally 11 bar	Steam pressure, normally 11 bar
Off-gas treatment	Bag filter	Bag filter	ESP & SO ₂ scrubber, wet ESP	Bag filter	Bag filter	Bag filter
Parameter	Emission levels (mg/Nm ³)					
Monitoring frequency	4 times per year		Once a month (7-hour sampling period)		Once every 6 months	Once every 6 months
Dust	12 (*)		1.1–4.6		16 (*)	17 (*)
Monitoring frequency	Continuous		Continuous		Not applicable	Not applicable
SO ₂	5–644 daily average; 145 yearly average		< 50–950 half-hourly average; < 50–300 daily average; 50–150 yearly average		Not measured	Not measured
Monitoring frequency	Not applicable		4 times per year (3*30 min)		Not applicable	Not applicable
Cu	Not measured		0.2–0.8		Not measured	Not measured
Pb			< 0.01–0.5			
As			< 0.01–0.05			
Cd			< 0.01–0.02			

Table 3.41: Operational and performance data for concentrate drying (part 2)

Company	Boliden Harjavalta	Boliden Rönnskär	KGHM, Głogów 1	KGHM, Głogów 2	KGHM Legnica
Dryer type	Steam dryer	Steam dryer	4 rotary dryers (2–3 in operation)	Rotary dryer	Rotary dryer (2 in operation)
Dryer capacity	125 t/h charge	Two 58 t/h charges	One 75 t/h charge; three 55 t/h charges	110 t/h charge (will be expanded to 132 t/h)	50 t/h charge
Dryer heating	Steam 0.18 t/t conc.	Steam	Combustion of natural gas	Combustion of natural gas	Combustion of natural gas
Off-gas treatment	Bag filter	Bag filter	Venturi scrubber (2 pcs)	Electrostatic precipitator	Bag filter
Parameter	Emission levels (mg/Nm³)				
Monitoring frequency	Continuous	4 times per year	Once a month	Once a month	4 times per year
Dust (minimum–maximum) (average)	0.2–6.1 daily average; 1.8 yearly average	0.17–2.69 1.03	Not representative	5–25 5.38	1.54–10 3.7
Monitoring frequency	Not applicable	Not applicable	Once a month	Once a month	4 times per year
SO₂	Not measured	Not measured	SO ₂ < 15	SO ₂ < 25	2–420 80
Monitoring frequency	Not applicable	Twice a year	Once a month	Once a month	4 times per year
Cu	Not measured	0.06–0.17	Not representative	0.17–6.88	< 0.01–1.36
Pb		< 0.01–0.022		0.01–2.5	< 0.01–0.62
As		< 0.01–0.036		0.001–1.2	< 0.01–0.111
Cd		< 0.001–0.0006		< 0.005	Not reported
NB: Metal emissions largely depend on the composition of the raw materials used, the type of process and the efficiency of the dust filtration system. (*) Average of the samples obtained during one year. Source: [378, Industrial NGOs 2012] [385, Germany 2012]					

At Aurubis Hamburg, according to the data given by a German authority, the emissions of dust are, under normal operating conditions, below 5 mg/Nm³ and the emissions (in 2011) of SO₂ were below 225 mg/Nm³ in 95 % of the half-hourly average values monitored, and below 300 mg/Nm³ in 99 % of the daily average values monitored in 2011.

The bag filter, compared to an ESP and a Venturi scrubber, performs better for reducing dust emissions; additionally, the bag's surface can also be used for the reduction of SO₂ when lime injection is used. The removal efficiency that can be achieved by the Venturi scrubber for fine dust is too low to deal with the emissions from the dryer.

Qualitative dust monitoring is applied using dust impingement, optical or triboelectric devices, and is used to detect filter bag failure. The pressure drop is monitored to control the cleaning mechanism.

In some cases, dry concentrate is reported to have an ignition temperature of between 300 °C and 400 °C. The oxygen content of the gases in a hot air dryer is low and the operating

temperature is controlled at a maximum tolerable level, mostly by mixing it with cold air. Similarly, steam coil dryers can maintain a low temperature in the concentrate and a low airflow rate, which can achieve the same effect. Nitrogen may also be used to prevent autoignition. Heat detection can be used to identify hot spots and trigger nitrogen quenching [103, COM 1998].

Cross-media effects

Bag filter and ESP

- Increase in energy use.

Scrubber

- Increase in energy use (higher than for a bag filter).
- Need for chemicals.
- Water consumption and generation of waste water that requires treatment before discharge or reuse.
- Waste generation. The gypsum produced when using an SO₂ scrubber has to be recycled to the rotary dryer as part of the furnace flux feed, which requires additional energy and handling costs.

Technical considerations relevant to applicability

These techniques are generally applicable to new and existing plants with consideration of the dryer type. In the event of a high organic carbon content in the concentrates (e.g. approximately 10 wt-%), bag filters might not be applicable due to blinding of the bags. The reliability of the steam supply is usually connected to the use of a steam dryer.

The SO₂ scrubber is only applied for directly heated dryers. SO₂ treatment is not required for indirectly heated dryers.

The applicability of the wet scrubber may be limited in the following cases:

- very high off-gas flow rates, due to the cross-media effects (significant amounts of waste and waste water);
- in arid areas by the large volume of water necessary and the need for waste water treatment and the related cross-media effects.

Economics

Replacing a hot electrostatic precipitator with a bag filter involved investments of EUR 1.3–5 million (flow rate 100 000 Nm³/h). This wide range reflects not only the replacement of the end-of-pipe technique but also the cost of the associated revamping of the plant.

Driving force for implementation

- Environmental regulation requirements.
- Recovery of raw materials.

Example plants

Atlantic Copper Huelva (ES), Aurubis Hamburg (DE), Aurubis Pirdop (BG), Boliden Harjavalta (FI), Boliden Rönnskär (SE), KGHM Głogów 1, Głogów 2 and Legnica (PL).

Reference literature

[238, ECI 2012], [383, Copper subgroup 2012]

3.3.2.4 Techniques to reduce primary off-gas emissions from copper concentrate roasting

Fine-grained raw material, comprising concentrates and recycled sludge from the process, is roasted in a fluidised bed roaster furnace. The airflow is adjusted until the desired roasting level is reached for the materials. When roasting dried smelt materials, the arsenic is vaporised and the sulphur and organic matter, if present, are partially oxidised. The roasting is carried out at 600–700 °C and is autogenous, and so requires no external energy. The majority of the roasted raw material follows the off-gas from the furnace top. The fluidised roaster furnace is preferably used for copper concentrates with not too small a grain size, in order to avoid the overloading of the off-gas system. It is effective for the separation of arsenic and mercury in copper concentrates. Fluidised roaster furnaces are increasingly used for the processing of arsenic-rich copper concentrates, since there is a trend towards higher arsenic grades in several major copper mines at increased depth.

Description

The technique to consider is the use of a cyclone, cooling tower and dry electrostatic precipitator (ESP) followed by a conditioning tower and bag filter.

Technical description

The off-gas passes through a cyclone system, where most of the dust is precipitated and is transported via closed conveyors to a smelter furnace. After the cyclones, the off-gas goes to a cooling tower where the gas temperature is reduced from about 550 °C to about 310 °C, to fit the dry ESP operating range. After cooling, the gas is processed in the dry ESP where metal-containing dust is removed. This dust is transported to the smelter furnace. Arsenic and mercury occur as vapour at this temperature and pass through the filter.

The off-gas is then cooled further in a conditioning (second cooling) tower by water injection nozzles, reducing the off-gas temperature to about 120 °C. Arsenic and mercury then condense into the solid phase. Most of the roasted arsenic dust and mercury are separated in a fabric bag filter. The separated dust, known as roaster dust, is collected and transported in a closed system for waste storage in a concrete silo.

The off-gases, containing about 10 % SO₂, are further processed in a wet phase treatment circuit. All the bleed outputs from the wet phase treatment are treated in a central water treatment plant. The SO₂-containing process gas is then led to a mixing tower at a central gas scrubber, but can alternatively be routed directly to the sulphuric acid plant. Prior to the sulphuric acid plant, the sulphur (about 10 vol-% SO₂) and heavy-metal-bearing gases are also washed and cleaned to remove mercury. Mercury can be removed by a number of techniques, e.g. using selenium, adsorbent impregnation, HgCl₂ activated carbon filtration. The gas volumes range between 30 000 m³/h and 170 000 m³/h. Mercury (total) concentrations prior to filtration range from 10 µ/m³ to 9900 µ/m³, and after filtration from 3 µ/m³ to 50 µg/m³. This indicates 70–99.7 % removal, subject to the Hg removal technologies employed.

A flowsheet of a fluidised bed roaster furnace and gas treatment system is given in Figure 3.13.

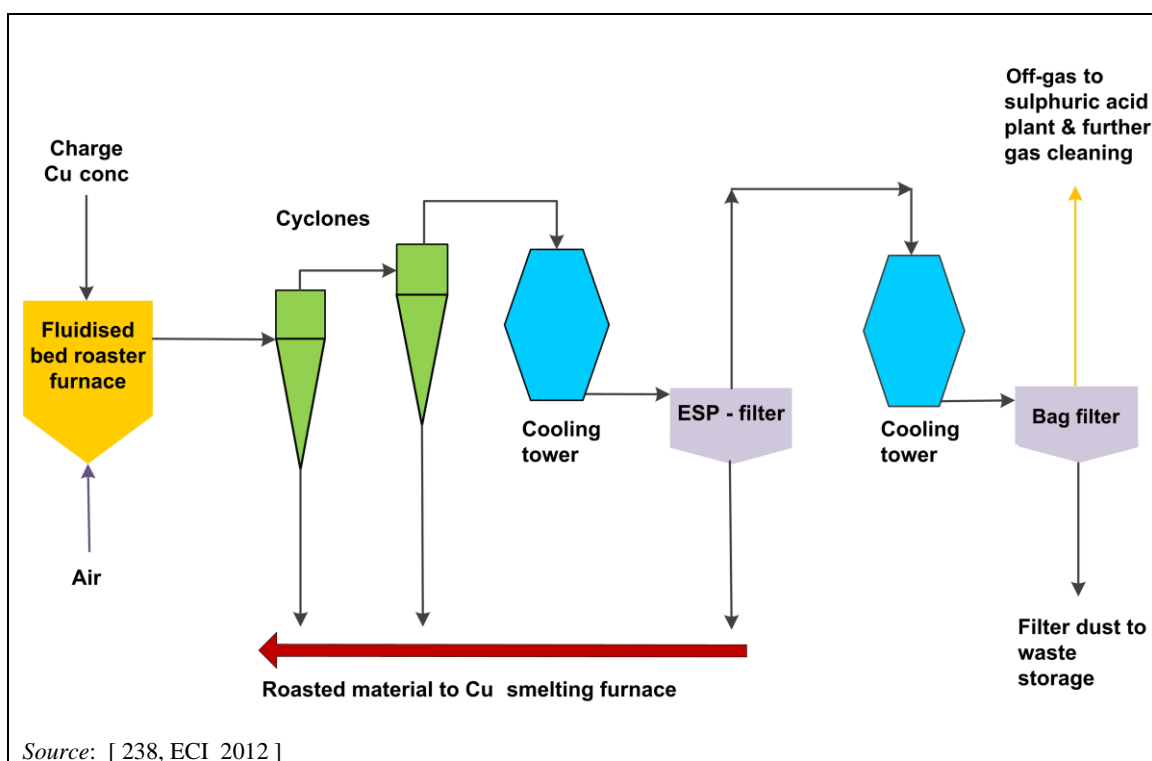

Figure 3.13: Flowsheet of a fluidised bed roaster furnace and gas treatment system

Achieved environmental benefits

- Reduction of dust and metals emissions.
- Recovery of raw materials.

Environmental performance and operational data

A fluidised bed roaster furnace was installed at the Boliden Rönnskär (SE) smelter in 1980 for the roasting of copper concentrates containing high grades of arsenic. The process unit is fully covered and integrated. It is operated and continuously supervised from a remote control room by operators.

The feed is 40–45 t/h and the air (fluidisation) 25 000–30 000 Nm³/h. The cooling tower consumes 5–10 m³/h of water. No channelled emissions occur at this stage because the off-gas is routed to a sulphuric acid plant where further gas cleaning is carried out.

Cross-media effects

- Increase in energy use.
- Consumption of water.
- Production of hazardous waste (roaster dust) to be landfilled.

Technical considerations relevant to applicability

Generally applicable. In existing plants, the bag filter can be integrated with the off-gas systems already present for the reduction of metals and the recovery of sulphur.

Economics

Investment estimates by Outotec, Sweden say the cost is EUR 200 million in an existing plant with infrastructure. The cost estimation includes the furnace, cooling towers, cyclones and filters.

Driving force for implementation

- Recovery of raw materials.
- Reduction of the roasted dust.

- Environmental regulation requirements.
- Reduction of the amount of arsenic in the following process steps such as smelting and converting. This is beneficial in order to maintain a good working environment and product quality.

Example plants

Boliden Rönnskär (SE).

Reference literature

[238, ECI 2012], [383, Copper subgroup 2012]

3.3.3 Primary and secondary copper production

3.3.3.1 Techniques to prevent and reduce emissions from the charging of furnaces/converters in primary and secondary copper production

Description

The techniques to consider are:

- briquetting and pelletisation of raw material;
- enclosed charging systems, such as a single jet burner, double bell, door sealing, closed conveyors/feeders, pneumatic injection into the bath;
- charging procedures, such as charging the furnace under reduced pressure, charging of converters during blowing, modification of charging systems to give small, even additions of raw material or a smooth continuous feed of materials;
- housing of the furnace, enclosures and hoods with efficient fume extraction and subsequent off-gas cleaning.

Technical description

The techniques applied to prevent and reduce emissions from charging operations depend on the type of furnace and the type of feed, such as dusty material, bulky solid feed or molten feed.

Briquetting and pelletisation of raw material

- Fine and dusty input materials are compressed in briquettes or pelletised. This operation is primarily done to meet the furnace requirements, but is also effective for the reduction of diffuse emissions.

Enclosed charging systems

- Enclosed conveyors or encapsulated feeders are applied.
- Ventilation systems for conveyors, transfer points, storage bins and feeders can be used.
- Sealed charging system of the flash smelter furnace (FSF) with a single jet concentrate burner.
- Shaft furnace charging via a double bell system. Loading sections are equipped with ventilation systems collecting the diffuse emissions and cleaning them in bag filters. Dedusted air may be used as blast air in the furnace or additional combustion air in a local power plant.
- Electric furnace charging by encapsulated lift charging system.
- Blast shaft furnace charging of solid feed by a skip door sealing system.
- Fine material can be pneumatically injected into the melting bath of the furnace.

Charging procedures

- Charging of furnaces/converters under reduced pressure, in order to reduce the blowing effect.

- Modification of furnace charging systems to give small, even additions of raw materials or a smooth continuous feed of materials in order to avoid puffs. In this technique the feed of the furnace is constant and there is no fluctuation in the emission. In some cases, a discontinuous feed causes puffs of process gases from the furnace. Therefore, in those cases a continuous feed is preferred.

Housing of the furnace, enclosures and hoods with efficient fume extraction and subsequent off-gas cleaning

- Furnace and charging points are under enclosure/hoods (e.g. TBRC, electric furnace).
- Charging holes are equipped with primary and/or secondary capture hoods and targeted fume collection systems (PS converters and rotary anode furnaces). Hoods are motor-driven for optimum collection efficiency. Automatic controls prevent blowing during the periods that the converter is 'rolled out' or 'rolled in'.
- Charging flux and scrap through the hood during the blowing of converters to avoid the rolling in or out of the hood and to reduce emissions.
- A crane-integrated hood can be used as a very effective device to reduce emissions from the charging and tapping of secondary converter furnaces (e.g. TBRCs).
- Charging systems are provided with extraction and a subsequent off-gas cleaning system. The ventilation air may be cleaned, together with the main stream of the off-gas from the furnace or separately, to be then returned to the furnace as blast air (or sent to the power plant as additional combustion air), or it may be cleaned in the central secondary gas-cleaning system (see Sections 3.3.3.2, 3.3.3.3, 3.3.3.5, 3.3.3.6, 3.3.4.1, 3.3.4.2 and 3.3.5.1).

TBRCs or electric furnaces and the charging points are under the hood or are located in an enclosed building with a ventilation system.

Achieved environmental benefits

- Reduction of dust, metals and other compounds emissions.
- Preservation of raw materials when filter dust is reused in the process.

Environmental performance and operational data

The FSF concentrate feeding system is applied in the Hamburg, Pirdop, Huelva and Głogów 2 plants. The dried feed mixture is collected in a charge bin and is fed by a loss-in-weight feeder into the central sealed concentrate burner, situated in the roof of the reaction shaft. A concentrate burner (single jet burner) with an air slide mixes the feed with oxygen-enriched air. At Hamburg, the electric furnace is charged via an encapsulated lift charging system. The top of the furnace is placed under enclosure. Fine and sludge-type feed materials are pelletised.

The charging of the KRS furnace (Lünen) is carried out in a sealed system. The charging systems are enclosed and provided with an off-gas capture system. Charging and discharging operations of the TBRC furnace are done with a crane, which has an integrated hood to capture the associated fumes. The hood is connected with the off-gas and filtering facilities by means of a belt system.

Blister and copper scrap (Aurubis Olen) are charged by a skip hoist to the shaft of the blast melting furnace and loaded into the furnace via a closed system.

At KGHM Głogów 1 and Legnica, the shaft furnace charging system includes three charge bins, for briquettes, coke and converter slag for each of the three furnaces. The actual charging of weighed portions of each of the materials is done automatically from the top of the furnace via a double bell system. The shaft loading section (of briquetted concentrate and auxiliary materials) is equipped with a ventilation system.

At Głogów 1, dust is collected in bag filters (3 x 21 000 Nm³/h) and returned to the process. Discontinuous measurements of dusts are carried out four times a year. Dust levels in the range

of 3–5 mg/Nm³ are achieved. Dedusted gas is returned to the shaft furnace as part of the air blown into the furnace to maintain the smelting process.

At Legnica, the dust from the ventilation system is collected in three bag filters. Discontinuous measurements of dusts are carried out four times a year. Dust levels in the range of 2–10 mg/Nm³ are achieved. Dedusted gas is utilised as additional air in the power plant.

At Głogów 2, there are no diffuse emissions from the charging area, as the charging is pneumatic and uses a loss-in-weight system. The air used for the pneumatic transport is dedusted in the dry ESP for air leaving the concentrate dryer.

At Metallo-Chimique, Belgium, all furnaces in the foundry are totally encapsulated to capture dust emissions from charging activities. Fine material is pneumatically transported and injected into the melting bath of the furnaces via double-walled pipes. Encapsulated vibrating feeders are also used. Furnaces are equipped with extraction and off-gas cleaning systems to reduce dust emissions and to adsorb dioxins and other volatile organic chemicals.

At Elmet, Spain, the smelter is totally encapsulated to capture dust emissions from charging activities.

At Montanwerke Brixlegg, the loading and tapping sections of the shaft furnace, the holding furnace, the converter and the anode furnace are equipped with ventilation systems for fume collection and cleaning in bag filters

Cross-media effects

Increase in energy consumption, for ventilation and operation of cleaning equipment.

Technical considerations relevant to applicability

Generally applicable depending on the furnace type, the type of process (batch or continuous operation) and the availability of space.

Economics

No information provided.

Driving force for implementation

- Reduction of diffuse emissions.
- Environmental regulation requirements.

Example plants

Atlantic Copper Huelva (ES), Aurubis Hamburg and Lünen (DE), Aurubis Olen (BE), Boliden Rönnskär (SE), KGHM Głogów 1, Głogów 2 and Legnica (PL), and Metallo-Chimique Beerse (BE).

Reference literature

[238, ECI 2012], [383, Copper subgroup 2012]

3.3.3.2 Techniques to prevent and reduce emissions to air from smelting furnaces in primary copper production

Copper concentrates are smelted in a furnace at high temperatures (> 1100 °C) to produce a melt that can be separated into a copper matte or blister copper and copper slag.

The following smelting processes are applied to matte:

- smelting using oxygen enrichment (e.g. flash smelting);
- batch smelting of dried or partially roasted concentrates in an electric furnace;

- smelting in a blast (shaft) furnace of concentrates with low iron and sulphur contents and a high carbon content;
- batch smelting via lance techniques (e.g. top-blown rotary or top submerged lance stationary furnaces);
- continuous smelting (e.g. cascading reactors, flash reactors).

Copper concentrates with low iron and sulphur contents can be smelted to blister directly in a blister furnace (e.g. flash), without the need for a converter stage. Of those, only flash smelting technology is used on a commercial scale, in Poland, Australia and Zambia. In the direct-to-blister process, blister copper is produced in one smelting step, thus avoiding transportation of molten matte in ladles as well as matte conversion. This eliminates the SO₂ emissions from ladle transfer and the converting step.

Other techniques such as the Mitsubishi continuous smelting, continuous flash converting, top submerged lance technology [305, Ausmelt 2009] and Noranda continuous smelting are applied, but outside the EU-28. In the flash smelting and flash converting (double flash) combination, molten matte is not transferred in ladles from the primary smelting furnace to the converter; instead the matte is granulated and ground and then fed continuously to the flash converter. Thus, SO₂ emissions from ladle traffic are avoided. As with the case of flash smelting, the SO₂-containing gas stream from the flash converter is continuous and does not fluctuate significantly. The small gas volume and high sulphur dioxide content of the gas makes gas cleaning and sulphur capture in the acid plant easier, and this improves the sulphur recovery efficiency.

Description

The techniques to consider are as follows:

- Sealed/encapsulated furnaces, oxygen enrichment, and operation under negative pressure.
- Housing, enclosures, covered launders and capture hoods with an efficient extraction and boosted suction system.
- Waste heat boiler (WHB) and hot ESP followed by a sulphuric acid plant (see Sections 2.12.5.4.1 and 2.12.5.4.2) or liquid SO₂ plant (see Section 2.12.5.4.3). These abatement techniques are considered for the treatment of primary off-gas from flash smelting and electric furnaces.
- Settling chamber, cyclone and Venturi scrubber followed by a power plant with a subsequent SO₂ abatement system. These abatement techniques are considered for the treatment of primary off-gas from shaft furnaces.
- Bag filter (with or without dry lime injection) or system of wet scrubber, semi-dry scrubber and bag filter for the treatment of secondary off-gas.

Technical description

Sealed/encapsulated furnaces, oxygen enrichment, and operation under negative pressure

Furnaces are effectively sealed during smelting processes to contain gases and prevent emissions, e.g. flash furnace, electric furnace. Furnace sealing relies on sufficient gas extraction rates to prevent pressurisation of the furnace. Operation is performed under negative pressure to prevent fume escapes (~ 50 Pa).

Oxygen enrichment is used to allow autothermal oxidation of the charge, including sulphide-based concentrates, and it produces process gases with adequate or high sulphur dioxide concentrations, which permits more efficient conversion and recovery processes at the sulphuric acid plant. This also allows the off-gas volumes to be minimised and the gas handling and abatement systems, including the sulphuric acid plants, to be reduced in size.

Housing, enclosures, covered launders and capture hoods with an efficient extraction and boosted suction system

The roofs of the flash smelting furnace reaction shaft, settler and uptake can be ventilated and the exhaust gases are captured. In addition, capture hoods are located above the slag and matte

tapholes. Ventilation systems are installed to collect diffuse gases produced during tapping. Gases from ventilation can be partially recirculated, for use in the FSF process.

Enclosed launders are used to remove the matte and slag from the furnace. During tapping, ladles are placed inside a housing/tunnel that is closed with a movable door/barrier to prevent gas leaks in the hall. Hoods are installed above the ladle loading area (see Figure 3.14). Hoods and enclosures are maintained under negative pressure to prevent leakages and to ensure optimal collection efficiency.

In some smelters, building roof extraction is also applied to capture residual diffuse emissions. Variable speed fans are used to provide extraction rates that are suitable for changing conditions.

Systems are used to operate the fans, valves and dampers automatically to ensure optimal collection efficiency and prevent diffuse emissions. Regular inspection and preventive maintenance of furnaces, ducts, fans and filter systems are carried out to ensure airtightness and prevent fugitive releases.

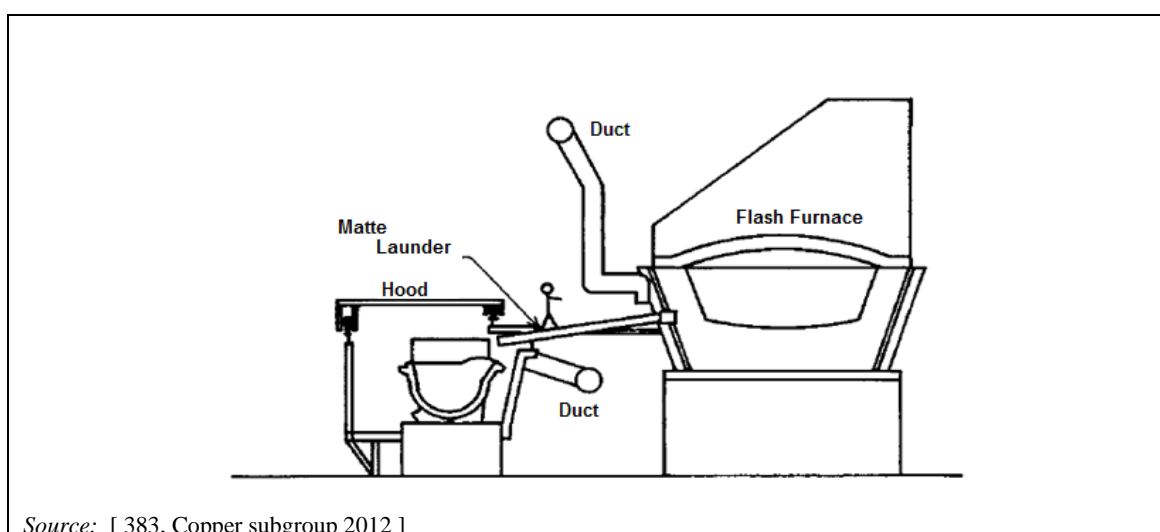

Source: [383, Copper subgroup 2012]

Figure 3.14: Local hood for matte tapping at the Toyo smelter

Waste heat boiler (WHB) and hot ESP followed by a sulphuric acid plant (see Sections 2.12.5.4.1 and 2.12.5.4.2) or liquid SO₂ plant (see Section 2.12.5.4.3)

The primary off-gases from concentrate smelting furnaces, such as the flash smelting furnace and electric furnace, are cooled in a waste heat boiler and further passed through a hot ESP for dust removal. Rough dust removal takes place in the WHB. The ESP is used to reduce the dust levels prior to the subsequent dust removal in the wet gas washing and cooling section. In most smelters, gases are mixed with the gases from the converters. SO₂-containing off-gases exiting the gas-cleaning stages are treated mainly in the sulphuric acid plant (see Section 2.12.5.4.1) or liquid SO₂ plant (see Section 2.12.5.4.3). Gas cleaning (removal of dust and, depending on the raw material processed and specifications of the produced acid, removal of mercury) before the contact process is essential to protect the catalyst and to produce a marketable acid.

Settling chamber, cyclone and Venturi scrubber followed by a power plant

The primary off-gases from the shaft/blast furnace are cleaned in the settling chamber, cyclone and Venturi scrubber, and (as they contain CO) are afterburnt in a power plant as additional fuel. Flue-gases from the power plant are desulphurised. The desulphurisation takes place in a semi-dry scrubber or in a polyether-based absorption/desorption process (see Section 3.3.3.9). The process gases from the furnaces contain a certain amount of dust (about 6–7 wt-% of the flash furnace feed) which is recycled to the furnace feed in a closed circuit.

Bag filter (with or without dry lime injection) or system of wet scrubber, semi-dry scrubber and bag filter

Secondary off-gases are cleaned in a gas-cleaning system (wet scrubber and/or bag filter). The shaft furnace loading section (of briquetted concentrate and auxiliary materials) is equipped with a ventilation system, and the exhaust gas is cleaned in bag filters (see Section 3.3.3.1) and (depending on the smelter) returned to the shaft furnace as part of the blown air or sent as combustion air to the local power plant.

Fumes collected from the furnace ventilation and ventilation of the taphole, launders and the ladle housing are treated in a bag filter with dry lime injection or a wet scrubber and a bag filter, depending on the SO₂ content. In some cases, dedusted ventilation gases are partially recirculated to the process or utilised as combustion air at local power plants after the flue-gases are desulphurised.

Achieved environmental benefits

- Prevention and reduction of dust and sulphur dioxide emissions.
- Efficient capture of the fumes at source and reduction of the diffuse emissions.
- Reduction of the quantity of fuel used by the oxygen enrichment.
- Recovery of sulphur and dust from dust removal systems.
- Production of steam from the waste heat boiler.
- Recovery of the energy content from the shaft furnace off-gas.

Environmental performance and operational data

The SO₂ is recovered in the form of sulphuric acid at the acid plants. Flue-dust collected in dust removal systems is recycled back to the smelting furnace. The steam produced from the waste heat boiler is used for drying copper concentrates, other production needs (e.g. copper refinery), or for the generation of electrical energy. The gases from the shaft furnace (containing ~ 10 % CO) are passed to the local power plant for incineration to eliminate CO and recover energy.

In primary flash smelting, one advantage is the reduced consumption of standard fuels and their emissions due to the optimum use of the heat value of the concentrates.

The main operational and performance data for primary smelting furnaces are summarised in Table 3.42.

The primary off-gases from the flash smelting furnace and from the direct-to-blister flash furnace, containing 20–45 % SO₂ and at a temperature of about 1350–1400 °C, are cooled in a waste heat boiler to below 400 °C. The gases from the boiler pass electrostatic precipitators for dust removal. In flash smelting to copper matte, gases are further mixed with the gases from the converters and treated in a sulphuric acid plant or liquid SO₂ plant (Hamburg, Pirdop, Huelva, Harjavalta, Rönnskär). In direct-to-blister flash smelting, gases are treated in a sulphuric acid plant after heat recovery and gas cleaning (Głogów 2). The levels of dust after the ESP are reported to be in the range of 50–150 mg/Nm³, before the washing section of the acid plant. The steam produced from the waste heat boiler is used for drying the copper concentrates, for the production needs in the tank house and the smelter, or for heating purposes (Pirdop, Hamburg, Boliden, Huelva, Głogów 2). The steam produced at 45 bar is also used to generate electrical energy, e.g. at Huelva (approximately 28.8 MW_{th}) and Głogów 2.

All smelters use oxygen enrichment, typically in the range of 40–60 % O₂ for the flash smelting furnace and about 25 % for the shaft furnace.

At Atlantic Copper, vent systems are installed to collect diffuse emissions produced during tapping. Gases from tapping and ventilation are partially circulated to the process air fan for use in the FSF process. The remaining FSF ventilation and tapping gases are treated in a bag filter with lime injection.

At Aurubis Hamburg, the roof of the FSF reaction shaft, settler and uptake shaft is vented and the vent gases are combined with the vent gases collected at tapholes, launders and ladle boxes

for housing the ladles during tapping. The gases are cleaned in a common secondary gas-cleaning system by a bag filter with dry lime injection (see Section 3.3.3.6).

In Pirdop, the tapholes are equipped with capture hoods, launders are covered and the ladle is placed in housing with a hood. The diffuse emissions produced during tapping are captured and treated for SO₂ and dust removal in a common secondary gas-cleaning system (wet scrubber and bag filter) (see Section 3.3.3.6). The ventilation gas from the taphole is ducted into the inlet of the process air fans to recycle the gas back into the burner of the flash furnace, instead of using outside ambient air. Roof extraction captures residual fugitive emissions and directs them to the gas-cleaning system.

At Boliden Harjavalta, the tapholes and discharging systems of the flash furnace are equipped with hoods and ventilation. Ventilation gases from the flash smelter area (110 000 Nm³/h) are treated in centralised bag filters and then emitted through the stack. Levels achieved are < 5 mg/Nm³ for dust and < 500 mg/Nm³ for SO₂, both as daily averages.

At Boliden Rönnskär, the hood tap gases from the electric furnace (250 000 Nm³/h) are treated in a bag filter. Dust and SO₂ are measured continuously. Levels achieved are < 5.46 mg/Nm³ for dust and < 562 mg/Nm³ for SO₂, both as daily averages.

At Głogów 1, the shaft furnace off-gases at a temperature of 300–650 °C are cleaned in a multistage system (settling chamber, cyclones and Venturi scrubbers). The relatively high concentration of carbon monoxide (around 10 %) makes the off-gases combustible, so they are transferred to the local power plant as additional fuel. Flue-gases from the power plant are desulphurised in a semi-dry desulphurisation plant, at an efficiency of about 82 %. Sulphur dioxide is absorbed from the gas into the suspension of Ca(OH)₂. All of the water from the suspension evaporates, and dry product is collected in bag filters. The clean gas contains < 20 mg/Nm³ of dust, and < 950 mg/Nm³ of SO₂. Dust collected in the bag filters is partially returned to the furnaces to improve the smelting processes, and partially landfilled. The tapping sections of the shaft furnaces (two in operation) are equipped with ventilation systems sucking in the diffuse emission, which is next cleaned in bag filters (60 000 Nm³/h) and utilised as additional air in the power plant. In this way, any SO₂ residue which may appear in this stream is finally desulphurised.

In Legnica, the shaft furnace off-gases at a temperature of 300–650 °C are cleaned in a multistage system (settling chamber, cyclones and Venturi scrubbers). The relatively high concentration of carbon monoxide (around 10 %) makes the off-gases combustible, so they are transferred to the local power plant as additional fuel. Flue-gases from the power plant are dedusted in electrofilters and next desulphurised in the polyether-based absorption/desorption plant, together with tail gases from the sulphuric acid plant (see Section 3.3.3.9). The shaft loading section (for briquetted concentrate and auxiliary materials, see Section 3.3.3.1) and shaft furnace tapping sections are equipped with ventilation systems, in which dust is collected in a bag filter. Dedusted gas is utilised as additional air in the power plant.

At Głogów 2, the flash furnace off-gases are transferred to a waste heat boiler to recover heat and some coarse dust. Then the gases are dedusted in an electrostatic precipitator and sent to a double conversion sulphuric acid plant (which includes a radial flow scrubber (RFS) and wet electrostatic precipitator for pretreatment). The concentrate is fed pneumatically to the feeding system of the flash furnace. Its off-gases are transferred to a waste heat boiler. There is a ventilation system at the tapping section of the flash furnace. Gases (about 100 000 Nm³/h) are dedusted in a bag filter, onto which some lime is blown to capture SO₂. This is in operation during the slag tapping. During copper blister tapping, an additional wet dedusting system – a Venturi scrubber with circulating soda solution – is used. Discontinuous measurements of dust and SO₂ are performed four times a year. Slag from the flash furnace is treated in an electric furnace, where a Cu-Pb-Fe alloy is formed to be further converted (see description in Section 3.3.3.4.2). The final slag is granulated.

Table 3.42: Operational and performance data for primary smelting furnaces (part 1)

Plant	Atlantic Copper	Aurubis Hamburg	Aurubis Pirdop	Boliden Harjavalta
Furnace type	FSF, Single jet burner, Oxygen enrichment 40–60 %	FSF, Single jet burner, Oxygen enrichment 55–60 %	FSF, Single jet burner, Oxygen enrichment 45–60 %	FSF, Single jet burner, Oxygen enrichment 65–85 %
Capacity	4000 t/d	4000 t/d	4000 t/d	2180 t/d
Primary gas handling	WHB and ESP steam 52 t/h	WHB and ESP steam 49 t/h, ESP dust < 100 mg/Nm ³	WHB and ESP steam 54 t/h, ESP dust < 150 mg/Nm ³	WHB and ESP steam 40 t/h
Primary gas treatment	Double contact/double absorption acid plant	Double contact/double absorption acid plant	Double contact/double absorption acid plant	Double contact/double absorption acid plant
Parameter	Primary gas emission levels (mg/Nm³)			
SO₂	See Section 2.7.2			
Secondary gas collection sources	FSF ventilation, tapholes, launders	FSF ventilation, tapholes, launders	FSF ventilation, tapholes, launders	Ventilation flash smelting area
Secondary gas treatment	Bag filter with dry lime injection	Bag filter with dry lime injection	Dry scrubber, wet scrubber and bag filter	Bag filter with dry lime injection
Max. flow rate (Nm³/h)	99 000	Not reported	Not reported	Not reported
Parameter	Secondary gas emission levels (mg/Nm³)			
Monitoring frequency	5 times per year	Continuous	Continuous	Continuous
Dust	Not representative	See Section 3.3.3.6 Centralised systems	See Section 3.3.3.6 Centralised systems	See Section 3.3.3.6 Centralised systems
Monitoring frequency	Continuous	Continuous	Continuous	Continuous
SO₂	Not representative	See Section 3.3.3.6 Centralised systems	See Section 3.3.3.6 Centralised systems	See Section 3.3.3.6 Centralised systems
Monitoring frequency	Not applicable	See Section 3.3.3.6 Centralised systems	See Section 3.3.3.6 Centralised systems	See Section 3.3.3.6 Centralised systems
Cu	Not measured	See Section 3.3.3.6 Centralised systems	See Section 3.3.3.6 Centralised systems	See Section 3.3.3.6 Centralised systems
Pb				
As				
Cd				
NB: Metal emissions largely depend on the composition of the raw materials used, the type of process and the efficiency of the dust filtration system. Source: [378, Industrial NGOs 2012]				

Table 3.43: Operational and performance data for primary smelting furnaces (part 2)

Plant	Boliden Rönnskär	KGHM Głogów 2	KGHM Legnica
Furnace type	FSF, Single jet burner, Oxygen enrichment ~ 55 %	FSF direct-to-blister	3 Shaft furnaces, 2 in operation, Off-gas 300–650 °C, Air blown 17 000–32 000 Nm ³ /h, Oxygen enrichment ~ 23.5 %
Capacity	Not reported	125 t/h	20–35 t/h
Primary gas handling	WHB and ESP steam 20 t/h	WHB and ESP steam 64 t/h	Settling chamber, cyclones and Venturi scrubbers, Power plant
Primary gas treatment	Double contact/double absorption acid plant and liquid SO ₂ plant	Double contact/double absorption acid plant (including RFS and wet ESP for pretreatment)	Combustion in the local power plant, as additional fuel, from which flue-gases are desulphurised in Solinox plant
Parameter	Primary gas emission levels (mg/Nm ³)		
Monitoring frequency	Not applicable	Not applicable	Not applicable
Dust	Not applicable	Not applicable	Not applicable
Monitoring frequency	See Section 2.7.2	Continuous	Not representative
SO ₂	See Section 2.7.2	140–800 (daily average) 270 (yearly average)	Not representative
Secondary gas collection sources	Ventilation gases from electric furnace, flash furnace and dryers	Ventilation of copper and slag tapping from flash furnace	Ventilation of material charging, melt tapping and charging vicinity from shaft furnaces
Secondary gas treatment	Bag filter	Semi-dry desulphurisation and bag filter	Bag filters and emission through stacks
Max. flow rate (Nm ³ /h)	331 000	132 000	22 000 maximum
Parameter	Secondary gas emission levels (mg/Nm ³)		
Monitoring frequency	Once a week	4 times per year (1 hour)	4 times per year (1 hour)
Dust	0.133–5.46 0.812 (yearly average)	1–5 2 (yearly average)	2–10
SO ₂	Not representative	0–100 23 (yearly average)	0.5–78
Monitoring frequency	12 times per year	4 times per year	Not reported
Cu	< 0.01–0.627	0.04–0.65	Not reported
Pb	< 0.01–0.119	0.1–1.1	
As	< 0.01–0.174	0.12–0.8	
Cd	< 0.01–0.005	0.005–0.05	
NB: Metal emissions largely depend on the composition of the raw materials used, the type of process and the efficiency of the dust filtration system. Source: [378, Industrial NGOs 2012]			

Cross-media effects

- Increase in energy consumption, for ventilation and operation of cleaning equipment.
- Wet gas cleaning systems (scrubber) may generate waste and waste water that require treatment before discharge, and also a solid waste to be disposed of.

Technical considerations relevant to applicability

Techniques are applicable to new and existing primary copper plants.

Waste heat boiler (WHB) and hot ESP

This technique is applicable to flash furnace and electric furnace primary off-gases and is associated with subsequent treatment in a sulphuric acid plant.

Settling chamber, cyclone, Venturi scrubber and power plant

This technique is applicable to shaft furnaces operating with concentrate with low sulphur and iron contents and a high organic carbon content.

Bag filter

This technique is applicable to the secondary emission.

Wet scrubber

Applicable for reduction of the SO₂ content in the collected secondary off-gases. The applicability of the wet scrubber may be limited in the following cases:

- very high off-gas flow rates, due to the cross-media effects (significant amounts of waste and waste water);
- in arid areas by the large volume of water necessary and the need for waste water treatment and the related cross-media effects.

Semi-dry scrubber

This technique is applicable to reduce the SO₂ content in the collected secondary off-gas in combination with a bag filter.

Economics

An investment of about EUR 10 million for an existing system to capture and treat fugitive gas in a primary copper smelter has been reported in Aurubis Hamburg (includes a bag filter, piping, hoods, fans, and process control).

At Aurubis Pirdop, investment costs of about EUR 1 700 000 were reported for improving the collection of fugitive emissions in the smelter. This included improvements to the hoods at the flash furnace area, closing the ladle tunnels with metal barriers during tapping, and the installation of a three-stage converter secondary hoods system.

Driving force for implementation

- Prevention and reduction of emissions.
- Raw material savings.

Example plants

Atlantic Copper Huelva (ES), Aurubis Hamburg (DE), Aurubis Pirdop (BG), Boliden Harjavalta (FI), Boliden Rönnskär (SE), KGHM Głogów 1, Głogów 2 and Legnica (PL).

Reference literature

[238, ECI 2012], [383, Copper subgroup 2012]

3.3.3.3 Techniques to prevent and reduce emissions from converter furnaces in primary copper production

The matte from the smelting furnace is converted into blister copper by blowing oxygen-enriched air into Peirce-Smith (PS) or Hoboken converters (the only two types of converter used in the EU-28). The converter is charged with liquid matte via ladles. The matte, along with auxiliary materials (scraps and flux), is charged through the converter throat. The slags and the copper blister produced during the conversion of the matte are subsequently poured back into ladles when leaving the converter. The converter is also used to handle the Cu-Pb-Fe alloy obtained in the electric furnace, which decopperises slag from the flash furnace. The blister copper obtained in the converters is then processed in anode furnaces.

Description

The techniques to consider are the following:

- Use of oxygen enrichment and operation under negative pressure.
- Capture hoods and the addition of materials (scrap and flux) through the hood for PS converters.
- Use of closed lids for Hoboken converters.
- Use of flash converting.
- Boosted suction systems to ensure fume collection and efficient extraction.
- ESP followed by a sulphuric acid plant (see Sections 2.12.5.4.1 and 2.12.5.4.2) or liquid SO₂ plant (see Section 2.12.5.4.3). These abatement techniques are considered for the treatment of primary off-gas.
- Bag filter with dry lime injection or use of a wet scrubber or semi-dry scrubber for the treatment of secondary off-gas.

Technical description

Converter furnaces generate emissions to air of dust, metals and SO₂. The transfer by ladle is also a potential source of diffuse emissions that may contain dust and sulphur dioxide. Techniques applied to prevent diffuse emissions and to collect the process gases emitted depend on the converter used.

In PS converters, the generated gases come out through the converter throat and are collected via capture hoods (see Figure 3.15). In Hoboken converters, gases do not pass through the throat but are sucked separately through a flue. In both types of converter, gases are then cooled, dedusted and sent to a sulphur recovery system to be converted into sulphuric acid or liquid SO₂.

Operation under negative pressure, capture hoods for PS converters and closed lids for Hoboken converters

Converters are operated under negative pressure. Primary off-gases of PS converters are collected via a primary hood over the converter opening. Materials (scrap and flux) can be added through the hood of the PS converter to prevent emissions. The secondary gases are captured at the point where they are generated, via capture hoods. PS converters are equipped with a system of up to three hoods, in addition to the main hood. These hoods can be connected either to the sulphuric acid plant (hood 1) or to the secondary cleaning system (hoods 2 and 3). During filling and pouring operations, the individual hoods are motor-driven to the positions that ensure optimum collection efficiency. Automatic controls prevent blowing during the periods that the converter is 'rolled out' or 'rolled in'.

The effluent gas of Hoboken converters is sucked through the flue at the end of the converter. The siphon minimises gas escape during all the phases of operation. The throats of Hoboken converters are equipped with special lids to prevent emissions during the conversion process. Whilst loading and emptying, negative pressure is maintained in Hoboken converters.

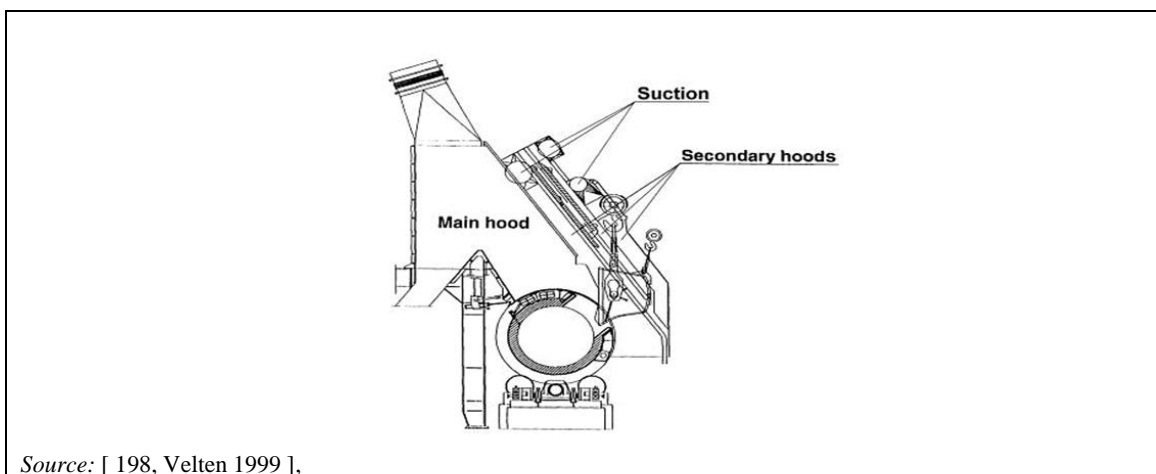

Source: [198, Velten 1999],

Figure 3.15: Secondary hooding system for a converter

Control systems to ensure fume collection and efficient extraction

Ducts and fans are used to convey the collected gases to abatement or treatment processes. The effectiveness of collection depends on the efficiency of the hoods, the integrity of the ducts and on the use of a good pressure/flow control system. Variable speed fans are used to provide extraction rates that are suitable for changing conditions, such as gas volume, with minimum energy consumption. Intelligent systems are used to operate the fans, valves and dampers automatically, to ensure optimal collection efficiency during the process stages that produce fumes. Regular inspection and preventive maintenance of furnaces, ducts, fans and filter systems are applied to ensure airtightness and prevent diffuse releases.

ESP followed by a sulphuric acid plant (see Sections 2.12.5.4.1 and 2.12.5.4.2) or liquid SO₂ plant (see Section 2.12.5.4.3).

Primary off-gases collected (with the primary hoods in PS converters or in a flue in Hoboken converters) contain high levels of SO₂, with a content of between 5 % and 15 %. They are typically cooled, treated in dust removal systems and passed to a sulphur recovery system, sulphuric acid plant or liquid SO₂ plant.

The converter off-gases are cooled either in evaporative cooling chambers, in waste heat boilers, or in atmospheric coolers. The gases are dedusted in electrostatic precipitators and may be mixed with other process gases from the smelting operations, such as for a flash furnace, prior to the gas cooling and cleaning section of the double contact/double absorption acid plant.

In one installation, the converter off-gases are treated in a single stage acid plant, with conversion (97 % efficiency), but the off-gases are treated in a desulphurisation plant (polyether) based on adsorption/desorption processes (see Section 3.3.3.9).

Bag filter with dry lime injection or system of wet scrubber, semi-dry scrubber and bag filter

Secondary gas captured by secondary hoods during the converter charge and discharge or collected via roofline extraction is treated in a gas-cleaning system. Gas cleaning is specific for secondary gases from the converter areas, or a common (centralised) system is installed to treat gases from various sources in primary smelters.

In some installations, the secondary gas-cleaning system consists of a bag filter with dry lime injection. In one installation, the secondary gases are cleaned in a central gas and dust cleaning system that consists of a wet scrubber, dry scrubber and bag filter (see Section 3.3.3.6).

A wet scrubber and cyclone droplet separation are used in one plant in the EU-28 to treat the primary off-gases from converting Cu-Pb-Fe alloy. These off-gases do not contain enough SO₂ to recover the sulphur in a sulphuric acid plant and they are desulphurised in a wet scrubber with soda.

Monitoring systems are established to detect leaks and failures in cleaning equipment. Maintenance of the collector hood, the ducts, the filter system and the fan is needed to ensure that collection or extraction rates remain at the designed level.

Use of flash converting

Outside the EU-28, the Kennecott-Outotec continuous matte converting process is used. In this process, the blister launders of flash converting furnaces are covered and the tapping openings are hooded for collection of secondary gases. The flash converting secondary gases are cleaned in a bag filter common to the flash smelting ventilation gases. The flash converter off-gases exit through the uptake shaft and are cooled in a waste heat boiler. The pressure and temperature inside the boiler are adjusted to prevent the condensation of sulphuric acid and excessive corrosion. For sulphation of the oxide flue-dust from the furnace, air is blown into the inlet of the radiation section. Part of the sulphatised dust settles in the waste heat boiler, the rest being recovered in the electrostatic precipitator. The dust layer accumulating on the collecting electrodes is returned back to the furnace. The gas is then routed to the gas-cleaning section of the sulphuric acid plant.

Achieved environmental benefits

- For the PS converter, the three-stage converter secondary hood system allows the capture of the off-gases generated in the different operation regimes of the converter at source, and reduction of the diffuse emissions.
- For the PS converter, separating the emissions into two different streams with high and low sulphur contents allows higher efficiency for sulphur recovery and for SO₂ abatement.
- Oxygen enrichment allows recovery of the heat to melt copper scrap.
- The Hoboken converter prevents the release of emissions during operation with closed lids.
- For the flash converter, the reduction of diffuse emissions and a more stable SO₂ content in the flue-gas.
- Production of steam from the waste heat boiler.
- Reduction of dust and sulphur dioxide emissions.
- Recovery of sulphur.
- Recovery of dust.

Environmental performance and operational data

Measurements in one primary copper smelter before and after installing diffuse emission prevention and abatement systems indicated that diffuse emissions accounted for up to 80 % of the total emissions from this sector, in comparison with non-diffuse emissions.

The SO₂ concentration of gases varies depending on the process cycle. During initial copper blowing, SO₂ concentrations can be higher than 10 %. However, during other blowing periods, and when the converter is charged or emptied, SO₂ concentrations are much lower, often even nil.

Atlantic Copper Huelva operates with four PS converters (three hot converters, two of them blowing at one time) with an average blowing rate of 37 000 Nm³/h. In the converter, off-gases are cooled in evaporative cooling chambers, one for each converter. Using two independent treatment lines, the gases are dedusted in hot electrostatic precipitators and then mixed with the gases from the flash furnace, before being sent to the gas cooling and cleaning section of the sulphuric acid plant. Converters have a control system to minimise the emission of diffuse gases when they enter or leave the hood. Scrap and flux are charged through the hood to the converter during blowing. Secondary gases captured by the secondary converter hoods are treated in a gas treatment system consisting of a bag filter with dry lime injection for the abatement of SO₂. The dust is partly recycled to the flash furnace feed.

At Aurubis Hamburg and Pirdop, three PS converters are installed; two converters blow parallel (blowing rate 750 Nm³/min). Scrap and flux are charged through the hood to the converter

during blowing. Thus, rolling the converters in or out of the stack is avoided, reducing the potential for gas release. The SO₂-containing process gases are collected in water-cooled primary hoods, dedusted in an ESP, and then conveyed to the acid plant for further treatment.

In Hamburg and Pirdop, the capture of secondary gases during converter charging, skimming or metal pouring is ensured by a secondary hood system at each converter. The gases captured are partly transferred to the acid plant, and the remainder is handled and dedusted in the common secondary gas handling and cleaning system. This comprises a wet scrubber and bag filter in Pirdop, and a bag filter with a dry lime injection in Hamburg. In Hamburg, when pouring slag, the ladle and the launder are closed by removable hoods and the gases captured and dedusted in the central secondary gas-handling system. In Pirdop, there is partial roof extraction to capture residual diffuse emissions and direct them to the gas-cleaning system.

Boliden Rönnskär operates three PS converters (two hot converters, only one blowing at a time). The converter off-gases pass through a waste heat boiler for energy recovery. The gas leaving the boiler passes an evaporative cooler for temperature adjustment and is then dedusted in a hot electrostatic precipitator, before entering the mixing tower ahead of the sulphuric acid/liquid SO₂ plant. Aisle ventilation, in the converter, collects diffuse gases which may be generated during converter operations such as matte and scrap charging, charging of other materials, slag skimming, and converter rolling in or out of the hood (flow rate 800 000 m³/h). These ventilation gases from the converter hall roof ventilation (three PS converters) and the tap gas from the flash smelting furnace are filtered in a bag filter.

At Boliden Harjavalta, two out of three hot converters can blow at a time while the fourth is being relining. Evaporative cooling is used to even out temperature peaks before the waste heat boiler. A hot ESP is used for dedusting. Secondary hoods and roof ventilation ports are used to collect off-gases escaping during charging/slag skimming/blister pouring, and to collect diffuse emissions caused by matte transportation. The collected gases are then routed via a bag filter to the stack. The roof of the aisle is closed. The ventilation duct is equipped with dry lime injection to capture part of the diffuse SO₂.

At the Głogów 1 plant, five Hoboken converters are in operation; three are usually hot, two under blow. The converter off-gases (flow rate 110 000 Nm³/h) pass through a settling chamber, atmospheric coolers and an ESP and are utilised in a double conversion sulphuric acid plant, which includes a radial flow scrubber and wet ESP for pretreatment.

In Legnica, the off-gases from Hoboken converters (flow rate 50 000–80 000 Nm³/h, temperature 300–350 °C, SO₂ concentration 5–12 vol-%) pass through a settling chamber, atmospheric coolers and ESPs and are utilised in a single contact sulphuric acid plant, which includes a wet scrubber (DynaWave®) and wet ESPs for pretreatment. The outlet gases, with a flow rate of 70 000 Nm³/h and containing about 6–8 g/Nm³ SO₂, are transferred to the polyether-based absorption/desorption plant for final desulphurisation to below 500 mg/m³ SO₂.

The throats of the Hoboken converters in Głogów 1, Głogów 2 and Legnica are equipped with special lids to prevent emissions during the operation. While loading and emptying, negative pressure is maintained in the converters.

At Głogów 2, the Hoboken converters process Cu-Pb-Fe alloy obtained in an electric furnace, used for flash furnace slag cleaning. Additionally, the converters receive solid metal spills and molten slag from rotary anode furnaces. The converter off-gas is handled in a dedicated wet cleaning system, consisting of a Venturi scrubber and cyclone droplet separator. The circulated liquid agent is a solution of soda, which also ensures desulphurisation of the off-gas.

At the Kennecott Utah Copper smelter (Magna, Utah, USA), a flash converting furnace (FCF) has been used to convert matte into blister copper since 1997. From the flash smelting furnace (FSF), the copper matte is tapped, granulated with water and stored in the blended storage area. Before going to the FCF, the matte is fed to a vertical roller mill where it is simultaneously

ground and dried. In the FCF, the matte is converted to blister copper and slag. The slag is tapped, granulated with water and recycled to the FSF. The blister copper (containing 0.1–0.5 % sulphur) is sent to the anode furnace. [52, Newman, C.J. et al. 1998]

The main operational and performance data for primary converters are summarised in Table 3.44 below.

Table 3.44: Operational and performance data for primary converters

Company	Atlantic Copper	Aurubis Hamburg	Aurubis Pirdop	Boliden Harjavalta
Converter data	4 PS converters (3 hot) Blow rate 37 000 Nm ³ /h	3 PS converters (2 hot) Blow rate 750 Nm ³ /min 24 % O ₂	3 PS converters (2 hot) Blow rate 3 000 Nm ³ /h 24 % O ₂	4 PS converters (3 hot, 2 blowing) Blow rate 450 Nm ³ /min 25–27 % O ₂
Primary gas handling	Evaporative coolers and ESP	ESP	Evaporative coolers and ESP	Heat waste boiler and ESP Steam 15 t/h
Primary gas treatment	Double contact/double absorption acid plant	Double contact/double absorption acid plant	Double contact/double absorption acid plant	Double contact/double absorption acid plant
Parameter	Primary gas emission levels (mg/Nm³)			
SO₂	See Section 2.7.2	See Section 2.7.2	See Section 2.7.2	See Section 2.7.2
Secondary gas collection sources	Converter secondary hoods	Converter secondary hoods Part of centralised system (see Section 3.3.3.6)	Converter secondary hoods Part of centralised system (see Section 3.3.3.6)	Diffuse collection converter area - converter aisle and converter ventilation hoods Part of centralised system (see Section 3.3.3.6)
Secondary gas treatment	Bag filter with dry lime injection	Bag filter with dry lime injection	Dry scrubber, wet scrubber and bag filter	Bag filter with dry lime injection
Max. flow rate (Nm³/h) (average)	350 000	Not reported	Not reported	Not reported
Parameter	Secondary gas emission levels (mg/Nm³)			
Monitoring frequency	Continuous	Continuous	Continuous	Continuous
Dust	3.2–6.6 4.7	See Section 3.3.3.6 Centralised systems	See Section 3.3.3.6 Centralised systems	See Section 3.3.3.6 Centralised systems
Monitoring frequency	Continuous	Continuous	Continuous	Continuous
SO₂	105–732 (daily average) 399 (yearly average)	See Section 3.3.3.6 Centralised systems	See Section 3.3.3.6 Centralised systems	See Section 3.3.3.6 Centralised systems
Monitoring frequency	Not applicable	See Section 3.3.3.6 Centralised systems	See Section 3.3.3.6 Centralised systems	See Section 3.3.3.6 Centralised systems
Cu	Not measured	See Section 3.3.3.6 Centralised systems	See Section 3.3.3.6 Centralised systems	See Section 3.3.3.6 Centralised systems
Pb				
As				
Cd				

Company	Boliden Rönnskär	KGHM Głogów 1	KGHM Głogów 2	KGHM Legnica
Converter data	3 PS converters (2 hot) Blow rate 750 Nm ³ /min 21–26 % O ₂	5 Hoboken converters (3 hot, 2 blowing) Blow rate 35 000 Nm ³ /h	3 Hoboken converters (converting Cu-Pb alloy obtained in electric furnace)	4 Hoboken converters (3 hot, 2 blowing) Blow rate 12 000 Nm ³ /h 23.5 % O ₂
Primary gas handling	WHB, evaporative cooler and ESP	Atmospheric coolers, ESPs	Not applicable	Atmospheric coolers, ESPs
Primary gas treatment	Double contact/double absorption acid plant and liquid SO ₂ plant	Double contact/double absorption acid plant (including RFS and wet ESP for pretreatment)	Venturi scrubber with soda solution, cyclone droplet separator	Single contact acid plant and Solinox plant (including Venturi scrubber and wet ESP for pretreatment) and then Solinox plant for final desulphurisation
Max. flow rate (Nm³/h)	Not reported	128 000	77 000	240 000
Parameter	Primary gas emission levels (mg/Nm³)			
Monitoring frequency	Not applicable	Not applicable	12 times per year (1 hour)	Not applicable
Dust	Not relevant	Not relevant	3–15 4.6 (yearly average)	Not relevant
Monitoring frequency	Not applicable	Not applicable	12 times per year (1 hour)	Not applicable
Cu	Not relevant	Not relevant	0.01–1.7	Not relevant
Pb			0.25–2.0	
As			0.02–3.8	
Cd			0.0004–0.03	
Monitoring frequency	See Section 2.7.2	Continuous	Continuous	26 times per year (1 hour)
SO₂	See Section 2.7.2	5–800 (daily average) 140 (yearly average)	0–200 (daily average) 81 (yearly average)	40–500 (yearly average) 300 (yearly average)
Secondary gas collection sources	Converter hall roof ventilation (3 PS converters) + tap gas from FSF	Special lids to prevent emission during operation. Negative pressure kept in converters during loading and emptying	Special lids to prevent emission during operation. Negative pressure kept in converters during loading and emptying	Special lids to prevent emission during operation. Negative pressure kept in converters during loading and emptying
Secondary gas treatment	Bag filter with dry lime injection	In Hoboken converter diffuse emission is eliminated, no need for ventilation system	In Hoboken converter diffuse emission is eliminated, no need for ventilation system	In Hoboken converter diffuse emission is eliminated, no need for ventilation system
Max. flow rate (Nm³/h)	846 000	Not applicable	Not applicable	Not applicable

Parameter	Secondary gas emission levels (mg/Nm ³)			
Monitoring frequency	Twice a month	Not applicable	Not applicable	Not applicable
Dust	0.018–1.17 0.41 (yearly average)	Not relevant	Not relevant	Not relevant
Monitoring frequency	Continuous	Not applicable	Not applicable	Not applicable
SO₂	250 (yearly average)	Not relevant	Not relevant	Not relevant
Monitoring frequency	Twice a month	Not applicable	Not applicable	Not applicable
Cu	< 0.01–0.082	Not relevant	Not relevant	Not relevant
Pb	< 0.01–0.143			
As	< 0.01–0.041			
Cd	< 0.01–0.015			

Source: [378, Industrial NGOs 2012]

Cross-media effects

- Increase in energy consumption, for ventilation and operation of cleaning equipment.
- Treatment of large volumes of air and high energy consumption, particularly for roof extraction systems.
- Wet gas cleaning systems (scrubbers) may generate waste and waste water that require treatment before discharge, and a solid waste to be disposed of.
- A flash converting furnace requires granulated and ground matte, and copper scraps need to be melted in the anode furnace.

Technical considerations relevant to applicability

Generally applicable. Enclosure and closed lids are applied to Hoboken converters. The system of primary and secondary hoods is applicable to Peirce-Smith converters.

Flash converting furnaces are only applicable to new plants or major upgrades of existing plants. The applicability of the wet scrubber may be limited in the following cases:

- very high off-gas flow rates, due to the cross-media effects (significant amounts of waste and waste water);
- in arid areas by the large volume of water necessary and the need for waste water treatment and the related cross-media effects.

Economics

In one plant (Aurubis Pirdop), investment costs for improving the collection system of diffuse emissions in the smelter were reported to be about EUR 1 700 000. This involved the installation of a three-stage converter secondary hoods system, improvement of the hoods at the flash furnace area, and closing of the ladle tunnels with metal barriers during tapping.

In another company (Atlantic Copper), investment costs for the replacement of all primary converter hoods and scrap loaders and installation of secondary hoods and a secondary gas treatment system were EUR 16 million.

Investment costs of EUR 6 million were reported for an existing system to improve the capture and treatment of diffuse gas from converters in the primary copper smelter in Aurubis Hamburg (bag filter, piping, ventilation, lime injection system, fans, and process control).

Driving force for implementation

- Limitation of diffuse emissions.
- Environmental and health regulation requirements.

Example plants

Atlantic Copper Huelva (ES), Aurubis Hamburg (DE), Aurubis Pirdop (BG), Boliden Harjavalta (FI), Boliden Rönnskär (SE), KGHM Głogów 1, Głogów 2 and Legnica (PL), and Kennecott Utah Copper (USA).

Reference literature

[52, Newman, C.J. et al. 1998], [238, ECI 2012], [383, Copper subgroup 2012]

3.3.3.4 Copper-rich slag processing

Copper-rich slags from the smelting furnaces or from converters are treated to recover their copper content. Two processes are used:

- slag concentrator,
- slag furnace treatment.

3.3.3.4.1 Techniques to prevent and reduce emissions from copper-rich slag processing by slow-cooling, crushing, milling and flotation (slag concentrator)

Copper-rich slags from smelting and/or converting can be treated for copper recovery in a slag concentrator. This slag cleaning process is based on slow-cooling of the molten slag, crushing and wet grinding of the cooled slag and recovery of copper by flotation to produce a slag concentrate. A slag concentrator is used where sufficient space is available and where the final slag can be adequately treated or disposed of. In order to achieve a good metal recovery, the material for slag flotation needs to be milled to a fine grain size. This final slag can be used for different industrial applications, although its potential for use may be limited due to the fine particle size and so some slag may need to be disposed of. The slag concentrate is fed into the flash smelting furnace together with the primary concentrate.

The energy consumption of a slag concentrator is lower than for the electric slag cleaning furnace process. No additional energy is required for the gas-cleaning equipment. Higher copper recovery can be achieved than with slag furnace treatment.

The slag concentration plant operates flexibly, adapting to variations in the feed. Decoupling of the slag treatment from the main smelter process is realised.

Description

The techniques to consider are the following:

- Water sprays. Applied to suppress dust emission during handling, storage and crushing.
- Drainage system. Applied to recover water from all the operations performed under water spraying, to avoid soil and underground water contamination.
- Collection and reuse in the process of the water from the cooling area and the flotation process as well as from the hydro transport of the final slag.
- Special design for the slag storage basin to protect the soil and prevent underground water contamination, and retention of a water layer to prevent diffuse dust emissions. The final slags are transported to the final storage using hydro transport in closed pipelines.

Technical description

In the slag concentration process, slag is cooled by air and water sprays in ladles or pits. Drainage systems are installed at the cooling areas and water is recirculated. Water sprinkling facilities are installed at handling and storage areas to suppress dust emissions.

Single stage crushing is performed. Water sprinkling facilities can also be installed at the inlet of crushing and transfer points after the reception bins. The grinding process is a two-stage process, where the first step is an autogenous mill and the second a ball or pebble mill. The primary mill can be in an open or closed circuit, depending on the secondary stage. In the closed circuit process, the classifier can be a screen, spiral or cyclone type. The secondary stage is in a closed circuit with cyclones.

Secondary grinding overflow is followed by flotation, which typically comprises a rougher, scavenger and two cleaning stages. Scavenger concentrates and first cleaner tails are circulated back to the rougher. Flotation is a physical and chemical process done in natural pH with a xanthate collector and frother. Grinding and flotation processes are performed with water, thereby preventing emissions to air.

Copper concentrate is dewatered conventionally with a thickener and vacuum filter. Filter cake, together with the smelting feed mixture, goes to drying and back to the smelting furnace.

Water is recirculated by drainage pumps and reused in the process.

The final slags are transported to a pond using hydro transport in closed pipelines. The solids settle in the pond; water is decanted and returned to the flotation process. The dam wall and the bottom of the pond are protected with high-density polyethylene (HDPE) lining to prevent infiltration into the soil and underground waters. In order to prevent the drying out of solids and dust emissions, a water layer is kept on the surface of the pond. Dust suppressants, such as lime milk, can also be used on dry areas.

Achieved environmental benefits

- Minimisation of emissions to air, as slag cleaning is a wet process.
- Water is reused.
- Recovery of copper, and raw material savings.
- Protection of the soil and of the groundwater.
- Final slag can be used for different industrial applications, such as road construction and other fill applications, for clinker production or as a mineral addition to blended cements, or as a component for iron/steel production.

Environmental performance and operational data

At Boliden Harjavalta, the slag from the copper flash furnace and the converters is treated for copper recovery in the slag concentrator. Slag is slow-cooled in ladles by a water spray. After cooling, the ladles are emptied by a hydraulic hammer. Then the slag is crushed by a cone crusher, ground by a lump mill and pebble mill, and treated in the slag concentrator. Copper-bearing particles are separated in flotation cells using air, water, flotation oil and xanthates. The slag concentrate is then thickened, filtered and recycled back to the copper flash furnace feed mixture.

The final tailings from the slag concentrator, mostly iron silicate, are discarded from the flotation cells and pumped into a specially prepared tailings storage area. Slag cooling area water handling is a part of the water circuit of the slag concentrator. The water in the slag concentrator is recycled and bled out to water treatment.

At Boliden Rönnskär, the slag from the copper flash furnace is treated for copper recovery in a slag concentration process. The slag is cooled in ladles, crushed and transported by covered trucks to a slag concentrator, where copper is recovered by milling and flotation. The concentrate is recycled to the copper furnace feed mixture. The final tailings are pumped in a

specially prepared tailings storage pond, together with flotation tailings from ore flotation. The water in the slag concentrator is recycled.

At Aurubis Pirdop, the flash furnace and converter slags are transported to the cooling area by railway wagons. Slag is cooled in crystallisation pits by consecutive air and water cooling. Equipment includes a drainage system and pump station. All water for cooling is recycled. The cooled slag is excavated and transported to a receiving hopper or open storage area. Single stage crushing is performed by a jaw crusher. Crushed slag is transported by a rubber belt conveyor to two bunkers and then fed to the grinding section for grinding and classification. Grinding is performed in two stages.

Primary grinding takes place in autogenous mills. The first autogenous mill (capacity: 45–50 tonnes/hour) operates in a closed circuit with a spiral classifier. Overflow from the classifier enters a pump sump, and power hydrocyclones. The second autogenous mill (capacity: 100–105 tonnes/hour) operates in a closed circuit with two hydrocyclones. Secondary grinding takes place in a ball mill operating in a closed loop with three hydrocyclones.

The hydrocyclone overflow goes to flotation. The flotation comprises a classic circuit: rougher, scavenger and two cleaning flotations. First, cleaner tailings, together with scavenger concentrate, are pumped to the second rougher flotation. Second, cleaner tailings are pumped to the first cleaning.

The slag concentrate slurry is pumped from the flotation cells to a thickener. The thickener underflow is filtered with a disk vacuum filter. The slag concentrate formed on the filter is returned to the flash smelting furnace. The thickener water overflow is pumped via a tank to the process water reservoir, closing the circulation water cycle of the flotation plant.

All areas have floor sumps for the collection of spillages.

The final slag is pumped to a tailings pond by two slurry pumps in series operation. Slag is settled and water is pumped to a collecting tank, from where it returns to the slag concentrator to be used as process water.

The tailing pond is contained by a dam wall. The dam wall and the bottom of the pond are protected with high-density polyethylene (HDPE) lining to avoid infiltration into the soil and underground waters. The surface of the pond is kept under a layer of water to avoid fugitive emissions of dust.

Cross-media effects

Water sprinkler

Increase in water consumption.

Technical considerations relevant to applicability

Generally applicable.

Economics

The slag concentrator requires:

- consumption of reagents: xanthate ~ 240 g/t; frother ~ 7.5 g/t;
- power consumption for grinding: autogenous mill ~ 18.2 kWh/t; ball mill ~ 14.3 kWh/t.

Building a final slag tailing pond (capacity of 1.6 million m³) involved an investment of up to EUR 8 million (2002, Aurubis Pirdop), including pump station, pressure steel duct, and closed circuit water system.

An upgrade and increase of capacity of the pond to 3.65 million m³, total area 220 acres, involved an investment of EUR 6.5 million (2008, Aurubis Pirdop).

Building 45 new cooling and crystallisation pits involved an investment of EUR 1.350 million (2007–2009, Aurubis Pirdop)

A project for expanding and increasing the capacity of the flotation plant involved an investment of up to EUR 14 million (2010, Aurubis Pirdop), including for a second autogenous mill and additional flotation cells.

Driving force for implementation

Minimisation of emissions to air and water.

Example plants

Boliden Harjavalta (FI), Boliden Rönnskär (SE), and Aurubis Pirdop (BG).

Reference literature

[238, ECI 2012], [383, Copper subgroup 2012]

3.3.3.4.2 Techniques to prevent and reduce emissions from copper-rich slag furnace treatment (electric furnace or slag fuming)

Slag furnace treatment is used to recover copper from copper-rich slag and to produce a final slag. Different processes are applied.

- Slag from the flash furnace and converter is treated in an electric arc furnace (EAF). Cleaning is carried out by carbon reduction, where a matte/metal alloy layer is settled and separated from the clean slag. Electric furnaces can be operated continuously or on a batch basis. The final slag is either granulated or cast in slag pots, slow-cooled in air, and then broken into stones.
- Slag from the electric smelting furnace may be treated together with zinc-containing dust for metal recovery in a fuming plant. The fuming plant consists of a fuming furnace and electrically heated settler. The fuming furnace is operated batch-wise. The melt is transferred into the electrically heated settler where matte and alloy are separated and tapped. The final slag is granulated. The heat from the fuming furnace cooling water is recovered and used for district heating.
- Slag from the secondary converters is treated in TBRC furnaces by reduction with iron scrap. The final slag is granulated.

Converter slag can also be returned in some cases to a smelting furnace, such as a shaft furnace. Other slags rich in copper like refining slags are usually recirculated to a prior process stage, mostly converting, or, in secondary smelters, to the smelting stage.

The final slag obtained has a low metal content and can be produced in different grain sizes (i.e. coarse lumpy, granules and down to finer grain material), which makes it suitable for use in a wide spectrum of industrial applications, for example as a sub-base layer or surface layer in road construction, aggregate for embankment construction, mine backfill, concrete applications and other fill applications, clinker production or mineral addition to blended cements, or as an abrasive blasting agent.

Description

The techniques to consider to prevent and reduce emissions from the furnace treatment of copper-rich slag are:

- design of the furnace and abatement system and negative pressure in the furnace;
- use of housing, enclosed/covered launders and ventilation hoods;
- afterburner;
- wet or semi-dry scrubber;
- dust filtration systems, such as a bag filter and ESP;
- dust suppression techniques, such as water spraying;
- recirculation and reuse of the water in the process.

Technical description*Design of the furnace and abatement system and negative pressure in the furnace*

Emission prevention is achieved by the correct design of the furnace and the abatement system. Negative pressure is maintained in the furnace and a sufficient gas extraction rate is applied to prevent diffuse emissions.

Use of housing, enclosures, covered launders and ventilation hoods

Enclosed launders are used to feed molten copper-rich slag to the electric furnace. Covered launders transfer clean slag into the granulation step or ladle. Covered launders transfer the matte/metal alloy to a ladle. Ventilation hoods are located above the furnace roof, tapholes, slag ladle and matte ladle. Ventilation systems are installed to collect diffuse gases from the fuming furnace and the settler. Hoods and enclosures are maintained under negative pressure to prevent leakages and ensure optimal collection efficiency.

Scrubber, bag filter and ESP

Electric furnace off-gas is afterburnt, cooled and cleaned in a bag filter with lime injection or a scrubber. The fuming furnace gases are cooled in a waste heat boiler (WHB) and evaporative cooler and dust is separated in electrostatic precipitators. TBRC furnace off-gas is cleaned in a bag filter. The separated dusts are recycled internally or externally for metal recovery.

Secondary gases are dedusted in a bag filter where relevant, with or without lime addition. Secondary gases may be treated together with process off-gases. Secondary gases from the furnace ventilation, and the ventilation of tapholes, launders and ladle hosing are treated in a bag filter with dry lime injection.

Dust suppression techniques, recirculation and reuse of the water in the process.

Regarding the cooling, handling and storage of final slag, slag granulation is performed by pouring it into water, using a high-pressure water jet or other quench systems, to form small evenly sized particles. The water effluent that arises from the granulation step is reused in the process in a closed circuit. To prevent a build-up of suspended solids and metal compounds, blowdown has to be continuously removed from the water circulation. Granulate is stored and handled in the open area. Slow-cooling of slag is performed in open pots. Lumps are stored and handled in an open area. Slag crushing can be performed in an open area. The crusher can be equipped with a hood and exhaust air can be cleaned in a bag filter. Water sprinkling facilities can be installed in handling, crushing and storage areas for final slag.

Achieved environmental benefits

- Reduction of dust and SO₂ emissions.
- Dust from dust cleaning equipment is reused internally or sent for recovery of metals.
- Recovery of copper and of raw material savings.
- Final slag can be used for different industrial applications.

Environmental performance and operational data

At Atlantic Copper, the flash furnace and the converter slags are treated in an electric furnace in a batch-wise process. The final slag is granulated with water. The gases from the electric furnace are treated in a wet scrubber with a closed liquid circuit (25 000 Nm³/h) for the reduction of SO₂ and dust. Discontinuous monitoring is carried out, at least four times a year: three 8-hour analyses. SO₂ levels of 10–200 mg/Nm³ are reported.

The ventilation gases of the electric furnace, tapholes, launders, and the hood above the slag ladle during tapping are cleaned in a bag filter. Solids collected during the scrubbing of the liquid are used for zinc recovery.

At Aurubis Hamburg, the combined smelting and converting slag is decopperised in an electric slag cleaning furnace. The converter slag can also be fed in molten form into the settler of the flash smelting furnace, where it is pre-reduced before electric furnace treatment. The electric slag cleaning furnace is operated continuously with semi-continuous slag inflow and tapping. The final slag is either granulated or cast in slag pots, slow-cooled in air, and broken into lump materials. The off-gases are afterburnt with controlled ingress air in the furnace. Through mixing with the vent gases from the launders, the gas temperature is reduced to less than 700 °C, then further cooled in a tube-type cooler and dedusted in the central bag filter for smelter secondary gases. The ventilation gases from the hood above the furnace roof, the tapholes, launders, the hood above the slag ladle and the ladle chamber for the matte ladle during tapping are also cleaned in the central bag filter for smelter secondary gases. All gases are cleaned in a common secondary gas-cleaning system by a bag filter with dry lime injection (see Section 3.3.3.6).

At Boliden Rönnskär, the slag from the electric copper matte smelting furnace, together with zinc-containing dust from the steel industry, is treated for metal recovery in a fuming plant. The fuming furnace is operated batch-wise. The melt is transferred into the electrically heated settler, where matte and alloy are separated and tapped. The slag is granulated and sold for different applications. The fuming furnace gases, containing volatilised zinc (and lead), are reoxidised and cooled in a waste heat boiler (WHB). After temperature adjustment in an evaporative cooler, the metal oxide dust is separated in electrostatic precipitators (two in parallel plus one in series), before release to atmosphere via a stack. The heat from the fuming furnace cooling water is recovered and used for district heating. The secondary gases from fuming, including the gases of the settler, are collected in a ventilation system and combined with the electric furnace gases; the gas stream is cleaned in a bag filter and released to atmosphere via a stack.

At KGHM Głogów 2, the flash furnace slag is cleaned in an electric furnace. The furnace is operated batch-wise. It produces Cu-Pb-Fe alloy and a final slag which is granulated with water. The off-gas is post-combusted and cleaned in two bag filters. Discontinuous monitoring is carried out, once a month. Levels of 1–5 mg/Nm³ for dust and < 100 mg/Nm³ for SO₂ are reported. The low SO₂ emissions are related to the low sulphur content in the concentrate used. The dust is utilised for lead production in Głogów 1. The electric furnace is charged with molten slag from the flash furnace. The slag is introduced through covered launders. The loading area of auxiliary materials (liquid converter slag, solid slag, coke, limestone) is equipped with a ventilation system with two bag filters. The tapping areas of Cu-Pb-Fe alloy and molten slag are also equipped with a ventilation system, from which the ventilation air is added to the main stream of electric furnace off-gas before the bag filters to be dedusted together. Additionally, the ventilation air cools the off-gas before entering the bag filters.

At KGHM Głogów 1 and Legnica, the final slag is produced directly in shaft furnaces. It is periodically tapped and transported in ladle cars to a yard for slow-cooling and crushing, to be used as road building material. The Hoboken converter slag is transported in ladle cars to a slag pit where it is cooled down, crushed and returned to smelting in the shaft furnaces.

At Metallo-Chimique Beerse, the slag from the refining furnace is treated in the TBRC slag furnaces for recovery of Cu, Sn, Pb and Ni. In a first stage, copper oxides are reduced by adding Cu/Fe scrap into the slag phase. The impure copper alloy metal obtained is tapped and returned to the refining furnace. In the next stage, the remaining Sn and Pb oxides are reduced with iron scrap, producing a complex multi-constituent alloy containing mainly Pb and Sn, but also Cu and Ni. This metal is further processed in a smaller TBRC furnace. The final clean slag is granulated in water. Slag furnace off-gas is cleaned in a bag filter. Discontinuous monitoring is carried out once a month. dust levels of $< 5 \text{ mg/Nm}^3$ are reported.

At Montanwerke Brixlegg, the slag from the shaft furnace is granulated with water. The converter slag is returned to the shaft furnace.

At Aurubis Lünen, the slag from the smelting stage of the KRS furnace is tapped via the slag taphole, first to a slag storage furnace, and then granulated with water. The metal-rich converter slag coming from the TBRC (or from the KRS, if the TBRC is out of operation) is processed in a tin-lead alloy furnace.

Operational data are summarised in Table 3.45.

Table 3.45: Operational and performance data for slag cleaning furnaces

Company	Aurubis Hamburg	Atlantic Copper	Boliden Rönnskär	KGHM Głogów 2	Metallo-Chimique Beerse
Feed	Flash furnace slag (including converter slag)	Flash furnace slag and converter slag	Slag from electric smelting furnace	Flash furnace slag	Slag from refining furnace
Furnace type	Electric furnace. 3 electrodes	Electric furnace. 3 electrodes	Fuming furnace. Settler	Electric furnace. 3 electrodes	TBRC furnace
Primary gas treatment	Afterburning. Cooling. Bag filter with dry lime injection	EF off-gases: gas cooling and scrubbing	WHB; evaporative cooler. ESPs (2 in parallel plus 1 in series)	Post-combustion and bag filter	Cooler. Bag filter
Secondary gas treatment	Treated together with primary off-gas. Central secondary gas-cleaning system Bag filter with dry lime injection (see Section 3.3.3.6)	EF ventilation gases taphole. Launderers: bag filter	Bag filter Treated together with electric furnace off-gases	Not applied	Bag filter
Max. flow rate (Nm³/h)	Part of centralised system (see Section 3.3.3.6)	Up to 180 000	Not reported	252 000	Not reported
Parameter	Emission levels (mg/Nm³)				
Source	Primary and secondary off-gas	Primary off-gas	Primary off-gas	Primary off-gas	Pb/Sn recovery
Monitoring frequency	See Section 3.3.3.6	5 times per year	12 times per year	12 times per year (1 hour)	See Section 3.3.5.3
Dust		Not representative	< 5	1–5 1 (yearly average)	
Monitoring frequency	See Section 3.3.3.6	15 times per year	Continuous	12 times per year (1 hour)	See Section 3.3.5.3
SO₂		10–200 80 (yearly average)	Not representative	0–100 19.6 (yearly average)	
Monitoring frequency	See Section 3.3.3.6	Not applicable	12 times per year	12 times per year (1 hour)	See Section 3.3.5.3
Cu		Not measured	< 0.01–0.03	0.01–0.4	
Pb			0.01	0.34–3.25	
As			< 0.01–0.1	< 0.01–0.2	
Cd	< 0.01–0.01		< 0.01–0.05		
NB: Metal emissions largely depend on the composition of the raw materials used, the type of process and the efficiency of the dust filtration system.					
Source: [378, Industrial NGOs 2012]					

Cross-media effects

- Increase in energy consumption, required for ventilation and operation of cleaning equipment.
- Wet gas cleaning systems (scrubbers) may generate waste and waste water that require treatment before discharge, and a solid waste to be disposed of.

Technical considerations relevant to applicability

Techniques are applicable to new and existing plants. For existing plants, consideration shall be given to the features and capacity of relevant existing equipment. The applicability of the wet scrubber may be limited in the following cases:

- very high off-gas flow rates, due to the cross-media effects (significant amounts of waste and waste water);
- in arid areas by the large volume of water necessary and the need for waste water treatment and the related cross-media effects.

Economics

Electric furnace power consumption: ~ 10–50 kWh/t slag.

Driving force for implementation

- Reduction of emissions.
- Recovery of metals.

Example plants

Atlantic Copper Huelva (ES), Aurubis Hamburg (DE), Boliden Rönnskär (SE), KGHM Głogów 2 (PL), and Metallo-Chimique Beerse (BE).

Reference literature

[238, ECI 2012], [383, Copper subgroup 2012]

3.3.3.5 Techniques to prevent and reduce emissions from melting and fire refining (anode furnace) in primary and secondary copper production

Description

Techniques to consider are:

- use of lids on the throats of rotary anode furnaces, hoods, and ventilation systems to capture fumes during charging and tapping;
- use of a bag filter with lime injection or a scrubber and wet ESP;
- in secondary copper production, use of an afterburner, quench, injection of lime and active coal before the bag filter;
- recovery of the waste heat of the off-gas to preheat the solid feed in a shaft furnace or to preheat the combustion air, or for drying operations.

Technical description

The furnace off-gases are afterburnt during the reduction stage, cooled and cleaned in fabric filters for dust removal. When the emission of SO₂ is relevant, a dry scrubber with lime injection is used. SO₂ and dust removal using wet scrubbers and a wet ESP is also applied. Afterburners destroy organic compounds, including PCDD/F (in secondary copper production), by thermal oxidation. An injection of lime and/or active coal before the bag filter is applied, if necessary, to abate the dioxin emissions.

Several techniques are used to minimise diffuse emissions:

- the throats of rotary anode furnaces are equipped with lids to reduce the diffuse emissions during the operation;
- hoods and ventilation systems are applied to capture fumes at anode furnace charging and tapping sections;
- ventilation gases at anode furnace charging and slagging sections may be used as air for combustion in a burner at the anode furnace.

Heat recovery from the refining furnace off-gas is used for heating/melting solid material in an anode shaft furnace. Hot gases from anode furnaces are also used in drying or other process stages. Gases extracted from ventilation hoods can be used as preheated combustion air.

Achieved environmental benefits

- Reduction of emissions to air.
- Collected dust is recycled back to the smelting process.
- Reduction of energy used.

Environmental performance and operational data

In one primary smelter, a reduction of diffuse emissions from the anode furnaces and the anode casting wheel of 70 % was achieved by the measures taken to enclose and exhaust the diffuse emissions from the area. Off-gases from the melting furnace (Contimelt) are directed upward through the shaft and preheat the charge before leaving the furnace at the top. Off-gases can be partly combusted in the anode furnace gas phase. Hot anode furnace off-gases are used in the drying of concentrates.

At Atlantic Copper Huelva (primary smelter), three refining furnaces are installed. The off-gases from fire refining are treated in three wet scrubbers, one for each furnace (flow rate 25 000 Nm³/h), and then in a wet electrostatic precipitator. The solids collected are components of decomposed and unburnt natural gas, condensed metal, and oxides; they are recycled to the process. Levels of < 8 mg/Nm³ for dust, < 60 mg/Nm³ for NO_x and < 150 mg/Nm³ for SO₂ are reported.

At Aurubis Hamburg (primary smelter), the anode furnace gases are channelled into an afterburning chamber and vent gases from the ventilation hoods are added for combustion and, in a second step, as cooling air. After further cooling in a tube-type air-to-gas cooler, the gases are dedusted in a bag filter (to dust levels of normally less than 5 mg/Nm³) and released via a stack to atmosphere. The dust precipitated is recirculated to the flash furnace. In 2009, a project for collecting and cleaning the diffuse emissions in the anode furnace and casting machine area was completed. It consisted of enclosing parts of the plant, suctioning of the off-gases and cleaning them in a new bag filter with lime injection. Continuous measurements are performed for dust and SO₂. Dust levels in the range of 0.5–10 mg/Nm³ (half-hourly average), and in the range of < 0.5–3.3 mg/Nm³ (daily average) are reported. SO₂ levels in the range of < 50–1050 mg/Nm³ (half-hourly average) and in the range of 50–180 mg/Nm³ (daily average) are reported. SO₂ is mainly formed during the oxidation step, therefore SO₂ emissions are much higher during the oxidation than during the reduction step.

At Aurubis Pirdop (primary smelter), the anode furnace off-gases pass through an afterburning chamber and are further desulphurised in a dry scrubber and dedusted in a bag filter in a centralised gas-cleaning system (see Section 3.3.3.6).

At Aurubis Lünen (secondary smelter), the charging holes, deslagging and tapholes are equipped with hoods and ventilation systems. The whole anode smelter building is ventilated, and the off-gases are cleaned in a separate filter unit with a capacity of 300 000 m³/h. The raw gas content is approximately 1000 mg/m³. The off-gas of the anode furnaces is cooled in waste heat boilers, dedusted in six bag filters and goes to atmosphere via two stacks. Continuous measurements are performed for dust, SO₂ and NO_x. Dust levels of < 0.5–6.8 mg/Nm³ (half-hourly average) and < 0.5–2.9 mg/Nm³ (daily average) are reported. Levels of SO₂ of < 50–1620 mg/Nm³ (half-hourly average) and < 50–450 mg/Nm³ (daily average) are reported.

PCDD/PCDF are measured once every three years (three 6-hour samples), and levels below 0.05 ng I-TEQ/Nm³ are reported.

At Aurubis Olen (secondary smelter), the Contimelt process is applied. The combustion gases of the melting furnace are directed upwards through the shaft and preheat the charge before leaving the furnace at the top. The poling furnace gases are afterburnt for the oxidation of CO into CO₂. Then the gas stream from the poling furnace passes through waste heat boilers for heat recovery. The gas stream from the melting furnace is first treated in a quench and a cyclone before it goes through a waste heat boiler. It is cleaned together with the gases from the poling furnace in a bag filter unit, prior to being released to atmosphere via a stack. A lime and active coal scrubbing unit has been installed before the bag filter, in order to abate dioxin emissions. Emission measurements are performed once a month. Levels of 1–6.7 mg/Nm³ for dust, < 1–427 mg/Nm³ for SO₂ and 178–500 mg/Nm³ for NO_x are reported. Measurements of PCDD/F are performed three times a year (6-hour samples). Levels of PCDD/F of 0.03–0.5 ng I-TEQ/Nm³ are reported. In Table 3.46, all the TVOC measurements taken in 2013 are reported.

Table 3.46: TVOC emissions of Aurubis Olen in 2013

Month	TVOC (mg/Nm ³)
January	9
February	19
March	26
April	10
May	14
June	10
July	6
August	23
September	28
October	13
November	50
December	22
NB: Data provided by the plant operator during the NFM final TWG meeting.	

At Boliden Harjavalta, off-gases are partly combusted in the anode furnace gas phase. An afterburner chamber is connected to the furnace to ensure that no CO enters the bag filters. Part of the hot anode furnace off-gases is used in the drying of nickel concentrates. The rest of the off-gases are dedusted after cooling in a bag filter and are then routed to the stack. The recovered dust is recycled to the flash furnace by a pneumatic conveyor. Roof ventilation ports are connected to the converter area ventilation bag filter to capture particulates.

At Boliden Rönnskär, the off-gases generated during fire refining are dedusted in a bag filter and released via a stack to atmosphere; the ventilation gases are also handled through this system. Dust is measured once a month. Dust levels of < 1 mg/Nm³ are reported. SO₂ and NO_x are measured once a year. SO₂ levels of < 500 mg/Nm³ and NO_x levels of < 400 mg/Nm³ are reported.

At KGHM Głogów 1 and Głogów 2 (primary smelters), the anode furnace off-gases are afterburnt and then mixed with ventilation gases from the tapping areas and treated together in a semi-dry desulphurisation system, followed by bag filters to capture SO₂ and dust emissions. The throats of rotary anode furnaces are equipped with special lids to reduce the diffuse emissions during the operation. Additionally, the loading and tapping sections of all anode furnaces have ventilation systems, from which gas is dedusted and desulphurised, together with the main stream of anode furnace gases. Emission measurements are performed once a month. Levels of 1–5 mg/Nm³ for dust and 10–200 mg/Nm³ for NO_x are reported. PCDD/F in the off-gas from the refining furnace were spot-checked and the concentrations were 0.036 ng I-

TEQ/m³ (while refining) and 0.121 ng I-TEQ/m³ (while melting copper scrap). For SO₂ emissions, 10–100 mg/Nm³ in Głogów 1 and 20–200 mg/Nm³ in Głogów 2 are reported.

At Legnica (primary smelter), anode furnace off-gases are afterburnt and dedusted in a bag filter, into which dry lime is blown for desulphurisation. The furnaces are equipped with special lids to reduce the diffuse emissions during operation. Additionally, the loading, tapping and slagging sections of anode furnaces have ventilation systems, from which ventilation air is partially used as air for combustion in the burners of the anode furnaces and partially added to the main stream of the anode off-gases into (mainly in the reduction stage) or after the afterburning chamber. The discharged clean gas contains: 0.2–1 mg dust/Nm³, 0.2–300 mg SO₂/Nm³ and 10–100 mg NO_x/Nm³. The casting area is also equipped with a ventilation system from which sucked air loaded only with vapour is discharged through the local stack (see Section 3.3.3.6).

At Metallo-Chimique Beerse (secondary smelter), a TBRC is used for fire refining (see Section 3.3.4.3). The off-gases from the existing anode furnace are treated by an afterburner and filtered by a bag filter. The new anode furnace is encapsulated to capture the dust emissions from charging and discharging (tapholes) activities. Off-gases pass through an afterburner chamber and are cleaned in a bag filter. Quantitative dust emissions data are collected and reported once a month. Dust levels of < 5 mg/Nm³ can be maintained, see Table 3.49 for operational data.

At Montanwerke Brixlegg (secondary smelter), off-gases are cleaned in a bag filter (150 000 m³/h). The heat is recovered in a waste heat steam boiler. The loading and tapping sections of the anode furnace are equipped with ventilation systems. Exhaust gases are cleaned in a bag filter. Levels of SO₂ at 20–50.4 mg/Nm³, dust at 0.6–3.8 mg/Nm³, and NO_x at 4.5–213 mg/Nm³ are reported.

Operational and performance data are shown in Table 3.47 for primary copper production and in Table 3.49 for secondary copper production.

Table 3.47: Operational and performance data for melting and fire refining primary smelters (part 1)

Plant	Atlantic Copper	Aurubis Hamburg	Aurubis Pirdop	Boliden Harjavalta
Type of furnace	3 rotary furnaces, 2 casting wheels. Casting capacity 70 t/h and 40 t/h	2 rotary furnaces, 1 casting wheel (80 t/h)	2 rotary furnaces, 1 casting wheel	2 rotary furnaces, 1 casting wheel (60 80 t/h)
Reducing agent	Natural gas	Natural gas	Propane-butane	Propane
Sources	Furnace off-gas	Furnace off-gas, Ventilation gas	Furnace off-gas, Ventilation gas	Off-gas, Roof ventilation ports
Gas treatment	Wet scrubber and wet ESP	Afterburning chamber, tube-type air-to-gas cooler, bag filter	Afterburning chamber, dry scrubber and bag filter as part of a common secondary gas-cleaning system (part of centralised system, see Section 3.3.3.6)	Afterburning chamber, cooling, bag filter with lime injection (part of centralised system, see Section 3.3.3.6)
Max. flow rate (Nm ³ /h)	47 000	70 000	See Section 3.3.3.6	See Section 3.3.3.6
Parameter	Emission levels (mg/Nm ³)			
Monitoring frequency	5 times per year	Continuous	Continuous	Continuous
Dust	Not representative	< 0.5–9.5 (half-hourly average) < 0.8–3.3 (daily average) 0.5–2 (yearly average)	See Section 3.3.3.6 Centralised systems	See Section 3.3.3.6 Centralised systems
Monitoring frequency	5 times per year	Continuous	Continuous	Continuous
SO ₂	< 10–337 50 (*)	< 50–1050 (half-hourly average) < 50–180 (daily average) 80–150 (yearly average)	See Section 3.3.3.6 Centralised systems	See Section 3.3.3.6 Centralised systems
NO _x	< 10–56 35 (*)	Not reported	Not reported	Not reported
Monitoring frequency	Not applicable	4 times per year (3*30min)	See Section 3.3.3.6 Centralised systems	See Section 3.3.3.6 Centralised systems
Cu	Not measured	0.03–1.5	See Section 3.3.3.6	See Section 3.3.3.6
Pb		< 0.01–0.52		
As		< 0.01–0.18		
Cd		< 0.02		

Table 3.48: Operational and performance data for melting and fire refining primary smelters (part 2)

Company	Boliden Rönnskär	KGHM Głogów 1	KGHM Głogów 2	KGHM Legnica
Type of furnace	2 rotary furnaces, 2 casting wheels (100 t/h)	2 rotary furnaces, one casting machine with 2 casting wheels	2 rotary furnaces, one casting machine with 2 casting wheels and 2 reverberatory furnaces, with one casting machine with one casting wheel	2 rotary furnaces, one casting machine with 2 casting wheels
Reducing agent	Ammonia	Natural gas	Natural gas	Natural gas
Sources	Off-gas, Ventilation gas	Off-gas, Ventilation system loading and tapping section and casting area	Off-gas, Ventilation system loading and tapping section and casting area	Off-gas Ventilation system for loading, tapping and slugging
Gas treatment	Bag filter	Afterburning, semi-dry desulphurisation, bag filter	Afterburning, semi-dry desulphurisation, bag filter	Afterburning, dry desulphurisation, bag filter
Max. flow rate (Nm³/h)	66 200	38 000	102 000	40 000
Parameter	Emission levels (mg/Nm³)			
Monitoring frequency	12 times per year	12 times per year (1 hour)	12 times per year (1 hour)	12 times per year (1 hour)
Dust	< 0.02–0.89 0.22 (*)	1–5 1.77 (*)	1–5 1.47(*)	0.2–1 0.7 (*)
Monitoring frequency	Once a year	12 times per year (1 hour)	12 times per year (1 hour)	12 times per year (1 hour)
SO₂	1–532 73.4 (*)	0–100 34.4 (*)	20–200 98.3 (*)	0.12–355 38.5 (*)
NO_x	Not reported	10–200 20.7 (*)	15–170 117 (*)	0.4–150 25 (*)
Monitoring frequency	Twice a year	12 times per year (1 hour)	12 times per year (1 hour)	12 times per year (1 hour)
Cu	0.005–0.45	0.16–3.38	0.04–0.4	0.01–0.158
Pb	Not reported	0.06–1.33	0.01–1	0.01–0.135
As	Not reported	0.07–0.9	0.05–1	0.0–0.115
Cd	Not reported	0–0.002	0–0.01	Not reported
(*) Average of the measurements taken in a year. NB: Metal emissions largely depend on the composition of the raw materials used, the type of process and the efficiency of the dust filtration system. Source: [378, Industrial NGOs 2012]				

Table 3.49: Operational and performance data for melting and fire refining secondary smelters

Company	Aurubis Lünen	Aurubis Olen	Metallo-Chimique Beerse	Montanwerke Brixlegg
Type of furnace	1 stationary furnace, 1 tiltable furnace, 1 casting wheel	Contimelt, Melting shaft furnace, Poling furnace, 2 casting wheels	2 rotary furnaces, 2 casting wheels	1 reverberatory furnace, 1 casting wheel
Reducing agent	Wood 20 kg/t Cu Natural gas 10 m ³ /t Cu	Natural gas	Natural gas	Natural gas
Sources	Off-gas, Hoods and ventilation charging holes, deslagging and tapholes, Anode smelter building ventilation	Off-gas melting furnace, Off-gas poling furnace	Off-gas, Ventilation system	Off-gas, Ventilation system
Gas treatment	WHB + bag filter Bag filter, lime injection	Quench, cyclone, WHB, bag filter Afterburning, WHB, bag filter Addition of lime and active coal	Existing: Afterburner + bag filter New: Afterburner chamber + cooler + bag filter	WHB + Bag filter
Max. flow rate (Nm³/h)	150 000	120 000	116 700	150 000
Parameter	Emission levels (mg/Nm³)			
Monitoring frequency	Continuous	Once a month (1*60min)	Twice a year (4 hours)	Continuous Discontinuous
Dust	< 0.5–6.8 (half-hourly average) < 0.5–2.9 (daily average), 2.1 (90 th percentile daily average) 0.9 (yearly average)	< 1–6.7 < 1–2.1 (*)	1–1.3 1.15 (*)	2 (daily average*) 0.6–3.8 (every 3 years 3x0.5 hours**)
Monitoring frequency	Continuous	Once a month (1*60min)	Not reported	(Every 3 years 3x0.5 hours**)
SO₂	< 50–1620 (half-hourly average) < 50–450 (daily average), 320 (90 th percentile daily average) 190 (yearly average)	50–427 70–260 (***)	Not reported	20–50.4 (every 3 years 3x0.5 hours**)
NO_x	< 50–350 (half-hourly average) < 50–210 (daily average) 105 (90 th percentile of daily average) < 50 (yearly average)	178–500 352–460 (***)	Not reported	4.5–213 (every 3 years 3x0.5 hours**)

Monitoring frequency	Every 3 years (6*0.5 hours)	Once a month (1*60 min)	Twice a year (4 hours)	Every 3 years 3x0.5 hours**
Cu	0.19–0.43	0.02–0.6	< 0.0005–0.2703	0.5
Pb	0.07–0.18	< 0.01–0.2	< 0.0005–0.1476	0.1
As	< 0.01–0.03	0.01–0.6	< 0.0005–0.0312	0.0019
Cd	0.001–0.003	< 0.2	< 0.0005–0.0111	0.01
Ni	< 0.01–0.01		< 0.0005–0.0077	0.0014
Sn	< 0.017–0.054	< 0.2	< 0.001–0.017	0.0028
Sb	0.001–0.003		< 0.0005–0.004	< 0.0001
TVOC	7–38	10–50	Not reported	0.2–15.9
Monitoring frequency	Not reported	Three times a year (6 hours)	Not applicable	(Every 3 years 3x3 hours**)
PCDD /PCDF	0.039–0.050 ng I-TEQ/Nm ³	0.03–0.5 ng I-TEQ/ Nm ³	Not reported	0.142–0.209 ng I-TEQ/ Nm ³

* Continuous measurement.
** Discontinuous measurement.
(***) Average of the measurements taken in a year.
NB: Metal emissions largely depend on the composition of the raw materials used, the type of process and the efficiency of the dust filtration system.
Source: [378, Industrial NGOs 2012], [385, Germany 2012]

Cross-media effects

- Increase in energy use.
- Effluent water is produced from the wet scrubber that needs additional treatment before discharge and there is solid waste to be disposed of.

Technical considerations relevant to applicability

The techniques are applicable to new installations and existing ones, depending on the feed material, furnace and reducing agent used.

The applicability of the wet scrubber may be limited in the following cases:

- very high off-gas flow rates, due to the cross-media effects (significant amounts of waste and waste water);
- in arid areas by the large volume of water necessary and the need for waste water treatment and the related cross-media effects.

Economics

Approximately EUR 7 million were invested in Aurubis Hamburg for measures to capture diffuse emissions from the anode furnace and casting wheel.

Approximately EUR 3.4 million were invested in Atlantic Copper for reducing emissions, including a wet ESP installation.

Approximately EUR 2 million were invested in Montanwerke Brixlegg for a new bag filter with a capacity of 150 000 Nm³/h, including four filter lines, a ventilator, chimney, building and pipework.

Driving force for implementation

- Reduction of emissions.
- Raw material savings.

Example plants

Atlantic Copper Huelva (ES), Aurubis Hamburg and Lünen (DE), Aurubis Olen (BE), Boliden Harjavalta (FI), Boliden Rönnskär (SE), KGHM Głogów 1, Głogów 2 and Legnica (PL), Metallo-Chimique Beerse (BE), and Montanwerke Brixlegg (AT).

Reference literature

[238, ECI 2012], [383, Copper subgroup 2012]

3.3.3.6 Centralised collection and abatement of secondary emissions from furnaces and auxiliary devices in primary copper production**Description**

Secondary gases from various sources in some primary copper smelters are collected centrally using the techniques described in the Section 2.4 and treated in a centralised gas-cleaning system (dry or wet scrubber followed by a bag filter).

Technical description

In some smelters, especially where Peirce-Smith converters are in operation, the collection and abatement of secondary emissions are carried out centrally.

Secondary gases from various points of the primary copper smelter, converter secondary hoods, ventilation hoods at the flash smelting furnace and at the electric slag furnace, the taphole and launder ventilation at smelting furnaces and at refining furnaces, and the ventilation hoods of anode furnaces and the casting wheel are collected in a common system.

As described in Sections 3.3.2 and 3.3.3, the SO₂ content is reduced by the use of a dry scrubber with an absorption agent or in a wet scrubber, and dust is eliminated in a bag filter before the flue-gas is released to atmosphere via a stack.

Achieved environmental benefits

- Reduction of diffuse dust and SO₂ emissions.
- Collection and treatment of many small streams of secondary gases where separate treatment would not be feasible.
- Potentially better treatment efficiency, by ensuring continuous and optimised flow and more stable pollutants concentration.
- Mixing wet gases with hot gases allows treatment in a bag filter, otherwise wet gases need to be treated in a scrubber.
- Mixing cold gases with hot gases from different sources allows specific parameters such as Pb and As to be reduced from the gaseous phase to the dust phase. This allows efficient treatment in a bag filter, which otherwise would not be possible.

Environmental performance and operational data

In one installation (Aurubis Hamburg, primary smelter), a common system for secondary gas capturing and cleaning is installed for a total gas flow of 930 000 Nm³/h, including the following sources: converter secondary hoods; ventilation hoods at the flash smelting furnace (FSF) and at the electric slag furnace; the taphole and launder ventilation of the FSF, of the electric slag furnace and of the anode furnaces; ventilation hoods of the anode furnaces; and ventilation of returns handling and the screening plant.

The collected gases are treated in a bag filter. For SO₂, dry lime is injected into the system before the bag filter. Part of the lime containing dust from the bag filter is recirculated and injected again, while the rest is withdrawn and recirculated to the flash furnace; 700 kg of dust is collected per hour. Dust is reused in the smelting furnace.

Relevant parameters are shown in Table 3.50 below.

Table 3.50: Relevant parameters for the centralised gas collection and abatement system at Aurubis Hamburg

Inlet conditions	
Max. design volume	930 000 Nm ³ /h
Volume variation	~ 500 000–880 000 Nm ³ /h
Absorbent for SO ₂ removal	Lime milk
Average dust & absorbent content	1 500 mg/Nm ³
SO ₂ inlet range	100–3000 mg/Nm ³
Outlet conditions	
Volume variation	~ 500 000–880 000 Nm ³ /h
dust emission	< 0.5–10 mg/Nm ³ half-hourly average (95 % of measured values in 2011 were < 1) 0.5–4.5 mg/Nm ³ daily average
Sulphur absorption	~ 50–70 %
SO ₂ outlet range	< 50–1275 mg/Nm ³ half-hourly average (95 % of measured values in 2011 were < 525) < 50–494 mg/Nm ³ daily average 300–430 mg/Nm ³ yearly average
<i>Source:</i> [383, Copper subgroup 2012], [378, Industrial NGOs 2012], [385, Germany 2012]	

The various sources of emissions have a wide range of SO₂ concentrations, as batch-wise operation leads to variations in the concentration of SO₂ in off-gases. The requirements to minimise the flow of the off-gas increase the emissions fluctuation.

In another installation (Aurubis Pirdop, primary smelter), a common system for secondary gas capturing and cleaning is installed for a total gas flow of 450 000 Nm³/h, including the following sources: converter secondary hoods; ventilation hoods at the flash smelting furnace; matte and slag taphole and launder ventilation at the flash smelting furnace; anode furnaces' process gases and secondary gases; extraction at the roof of the smelter building.

The gases are cleaned in a central gas and dust cleaning system that consists of the following parts.

- A semi-dry scrubber (lime spray dryer), designed to inject lime milk into the off-gas stream from the anode furnace, in order to coat the sleeves on the bag filter with hydrated lime.
- A wet scrubber, designed to remove SO₂ from the gas stream containing: the combined converter secondary gases, the converter roofline gases, and the FSF taphole gases and roof vent gases.
- A bag filter, designed to remove the particulates from the combined anode furnace exhaust gas, the converter secondary gas, the smelter building roofline ventilation gas, and the FSF slag and matte tapping gas streams. The inlet stream to the bag filter is the resultant mixture of the wet scrubber and the spray dryer outlet streams. The bag filter consists of six parallel compartments, arranged into two rows of three compartments. The bag cleaning system is fully automated based on low-pressure air pulses.
- A lime preparation station, which produces all the lime milk needed for the aforementioned processes.

Relevant parameters are shown in Table 3.51 below.

Table 3.51: Relevant parameters for the centralised gas collection and abatement system at Aurubis Pirdop

Inlet conditions	
<i>Dry scrubber</i>	
Gas volume	70 000–110 000 Nm ³ /h
Temperature	250–450 °C
Dust load	250–1000 mg/Nm ³
SO ₂	0–900 mg/Nm ³ , peak up to 1500 mg/Nm ³
<i>Wet scrubber</i>	
Gas volume	82 000–320 000 mg/Nm ³
Temperature	10–60 °C
Dust load	40–350 mg/Nm ³
SO ₂	1000–3900 mg/Nm ³ , peak up to 15 000 mg/Nm ³
Addition of lime milk	550 kg lime/h
<i>Bag filter</i>	
Gas volume	450 000 Nm ³ /h
Outlet conditions	
SO ₂ range	100–625 mg/Nm ³ daily average (90 th percentile of daily averages 377 mg/Nm ³ in 2011) 290 mg/Nm ³ yearly average
Gypsum produced	48–50 t/d
<i>Source: [378, Industrial NGOs 2012], [383, Copper subgroup 2012]</i>	

Dust and SO₂ are measured continuously, directly in the stack. Dust is measured by a two-beam alternate light analyser. SO₂ is measured by a differential optical absorption spectroscopy (DOAS) analyser.

Variations in emission values are due to the varied secondary and primary (anode furnace exhaust gas) sources, changes in the inlet conditions and concentrations of dust and SO₂, and the batch-wise operation.

At Boliden Harjavalta, a common system for secondary gas capturing and cleaning (bag filter with lime injection) is installed for a total gas flow of 900 000 Nm³/h including the following sources: converter aisle and converter ventilation hoods; anode furnace (when the flue-gases are not routed for concentrate drying); ventilation gases from copper and nickel flash furnace and nickel electric furnace areas.

The emissions are shown in Table 3.52.

Table 3.52: Emissions from the centralised gas collection and abatement system in Boliden Harjavalta

Parameter	Emission (mg/Nm ³)			Measurement
	Min.	Avg.	Max.	
Flow	317 200	665 000	890 000	Continuous (daily average)
Dust	0.01	0.14	5	
SO ₂	22	407	NR	
Cu	< 0.01	< 0.01	0.2	12 times per year (average over the sampling period)
Ni	< 0.01	< 0.01	< 0.01	
Zn	< 0.01	< 0.01	0.09	
As	< 0.01	< 0.01	0.2	
Pb	< 0.01	< 0.01	0.1	
Cd	< 0.01	< 0.01	0.01	
Hg	< 0.01	< 0.01	< 0.01	
NB: NR = Not representative. Source: [378, Industrial NGOs 2012]				

Cross-media effects

- Increase in energy use and operational costs due to high volume flow, and the operation and maintenance of many valves and fans.
- Installation and maintenance of very good control and measurement systems to enable optimal operation.
- Consumption of lime and water.
- Gypsum produced has to be reused in the smelting process, as calcium flux for slag formation, or must be disposed of.
- Effluent water is produced that needs additional treatment before discharge, creating a solid waste to be disposed of.

Technical considerations relevant to applicability

Generally applicable for new plants and for existing plants, though the applicability depends on site-specific conditions, and the design and layout of the existing installations have to be taken into account.

Economics

The investment costs at Aurubis Hamburg were EUR 10 million plus approximately EUR 7 million for measures to capture diffuse emissions from the anode furnace and casting wheel. The electrical energy consumption is 13.6 GWh/yr.

At Aurubis Pirdop, the secondary gas-cleaning system involved a capital expenditure of more than EUR 12.5 million. The energy consumption is 1.62 MW/h. And the lime consumption is 550 kg/h.

Driving force for implementation

- Reduction of emissions from many sources.
- Raw material savings.
- Better emissions collection and pollutants abatement efficiency due to continuous and optimised flow.

Example plants

Aurubis Hamburg (DE), Aurubis Pirdop (BG), and Boliden Harjavalta (FI).

Reference literature

[238, ECI 2012], [383, Copper subgroup 2012]

3.3.3.7 Techniques to prevent and reduce emissions from anode casting in primary and secondary copper production

The casting of molten copper from the anode furnace is carried out into a casting wheel or continuous caster. The continuous caster is only used outside the EU-28, in Japan and Indonesia.

The most commonly used technique is a casting wheel that comprises a series of anode-shaped moulds on the circumference of a rotating table. Molten metal first flows into a tundish, from where it is directed to an intermediate ladle which fills one or two casting ladles. The casting ladles fill the metal into the moulds and the wheel rotates, taking the anodes through a series of water jets to cool them.

Description

The techniques to consider are:

- enclosed tundish;
- closed intermediate ladle;
- hoods over the casting ladle and (part of) the casting wheel;
- roof extraction combined with treatment in a bag filter;
- scrubber or demister for particulate removal from ventilation gases from the casting wheel.

Technical description

A covered tundish, closed intermediate ladle, hoods over the casting ladles and the casting wheel, and roof extraction are used to prevent and reduce diffuse emissions during casting. Hoods and enclosures are maintained with efficient extraction. Collected fumes from the casting area are usually combined with the anode furnace off-gases and subsequently treated in bag filters (see Section 3.3.3.6).

Wet ventilation gases from the casting wheel cooling hood are treated in a scrubber or demister for particulate removal. Solids from the scrubber are recycled back to the smelter.

Achieved environmental benefits

- Reduction of diffuse emissions to air.
- Collected dust/solids are recycled to the smelting process.

Environmental performance and operational data

At Atlantic Copper, anode casting is performed with two fully automated casting wheels with 28 and 20 moulds. The casting rate is 70 t/h and 40 t/h. The water vapour produced and captured during casting is sent to a demister for collecting particulates, and the gas (47 000 Nm³/h) is then released into the atmosphere. Dust emissions of between 4 mg/Nm³ and 15 mg/Nm³ are reported. Water to cool the anodes is used in a closed loop system with a cooling tower.

In Aurubis Hamburg, anode casting is performed with a fully automated single casting wheel with 24 moulds. The casting rate is 80 t/h. The water vapour produced during casting is vented off from the system, particulates are precipitated in a demister and the gas is then released into the atmosphere, containing less than 5 mg/Nm³ solid matter as a daily average. In 2009, a project for collecting and cleaning the fugitive emissions in the anode furnace and casting machine area was completed. Part of the anode casting plant is encapsulated. A reduction of diffuse emissions from the anode furnaces and the anode casting wheel of up to 70 % was achieved by this project. Anode furnace off-gases are treated together with the dry exhaust streams from the casting system in a bag filter with lime milk injection.

In Aurubis Lünen, the whole anode smelter building is ventilated, and the off-gases are cleaned in bag filter units with a capacity of 300 000 m³/h.

In Boliden Harjavalta, anode casting is performed with a fully automated single casting wheel with 28 moulds. The casting rate is typically 70 t/h. Ventilation gases from the casting wheel cooling hood are treated in a vortex scrubber for particulate removal at a flow rate of 15 000 Nm³/h. Solids from the scrubber are bled to the anode casting closed cooling water circuit, and recycled batch-wise back to the smelting. Dust measurements after the scrubber are performed twice a year. Levels of 20 mg dust/Nm³ are reported.

In Metallo-Chimique Beerse, the new casting wheel is a fully automated single casting wheel. Ventilation gases from the casting wheel cooling hood are treated in a bag filter. Levels of dust are maintained below 5 mg/Nm³. Water to cool the anodes is used in a closed loop system. Solid particles from the anode cooling water are allowed to settle and are returned to the furnaces.

In KGHM Głogów 1 and Legnica, the anode casting is performed with a fully automated twin-wheel casting machine with two lots of 16 moulds. In Głogów 2, there are two casting wheels (a single casting wheel with 28 moulds for stationary anode furnaces and a twin-wheel casting machine with two lots of 18 moulds for rotary anode furnaces). The tapping sections of all anode furnaces have ventilation systems, from which gas is dedusted and desulphurised together with the main stream of anode furnace gases. During the casting process, molten copper from the anode furnace flows through a closed chute and a tundish to a casting area equipped with a ventilation system, from which sucked air loaded only with vapour is discharged through the local stack.

Cross-media effects

- Increase in energy use.
- Effluent water is produced from the scrubbers that needs additional treatment to prevent the discharge of metals to water.

Technical considerations relevant to applicability

Techniques for off-gas collection and subsequent filtration systems are applicable for new and existing installations, depending on the design and the availability of space for the casting equipment.

Economics

Approximately EUR 7 million were invested at Aurubis Hamburg for measures to capture diffuse emissions from the anode furnace and casting wheel.

Driving force for implementation

- Reduction of emissions.
- Raw material savings.

Example plants

Atlantic Copper Huelva (ES), Aurubis Hamburg and Lünen (DE), Boliden Harjavalta (FI), Metallo-Chimique Beerse (BE), KGHM Głogów 1, Głogów 2 and Legnica (PL).

Reference literature

[238, ECI 2012], [383, Copper subgroup 2012]

3.3.3.8 Optimised electrolysis in primary and secondary copper production

Description

Optimised electrolysis (electrorefining and electrowinning) involves using a combination of techniques to reduce emissions and energy consumption.

The techniques to consider are:

- optimised cell design, use of stainless steel cathode blanks or copper starter sheets;
- high degree of automation (cathode/anode changes and stripping operations) and quality control;
- covers, hoods and extraction systems;
- surfactant addition;
- closed storage tanks and closed pipelines for transfer of solutions;
- scrubbers or demisters;
- reduction of emissions to water by the recirculation of solutions for reuse or recovery of metals;
- usage of by-products (anode slime) for precious metal recovery;
- prevention of soil/groundwater contamination by the use of an impermeable and acid-resistant floor.

Technical description

Optimised cell design, use of stainless steel cathode blanks or copper starter sheets

Electrorefining processes that feature optimised cell design, anode/cathode spacing, anode geometry, current density, electrolyte composition, temperature and flow rate achieve low energy consumption and maintain high productivity. The use of stainless steel cathode blanks (i.e. permanent cathodes) or copper starter sheets is also applied (most copper refineries in the EU-28 apply permanent stainless steel cathode technology).

High degree of automation (cathode/anode changes and stripping operations) and quality control

The use of mechanised and automatic harvesting and stripping operations and short circuit detection prevent emissions and reduce the energy consumption.

Quality control is applied to ensure that anodes are straight, flat and exact in weight. Good, clean electrical contacts improve current distribution and energy consumption.

Covers, hoods and extraction systems

Electrorefining cells can be covered (e.g. with plastic, cloth or fibre sheets) to control the temperature and prevent the evaporation of water from the electrolytic solution. Extraction hoods are installed on electrorefining cells in special cases, e.g. where high-impurity (As, Sb, Bi, Pb, Ni) anodes are processed.

Electrowinning cells are covered by hoods and covers with integrated extraction units for sucking away the acid mist produced by oxygen evolution where relevant.

Electrowinning cells for bleed treatment are normally enclosed and can be equipped with exhaust ventilation, scrubbers and arsane detection systems. Arsane gas evolution can be avoided by maintaining the copper concentration in the feed solution at the optimum level compared to the current density used in the last stage of decoppering.

Water vapour and aerosols from the washing chambers of the cathode stripping and anode scrap washing machines are extracted.

Regular inspection and preventive maintenance of cells, tanks, pipes, pumps and cleaning systems are applied to ensure tightness and prevent leaks.

Surfactant addition

As an alternative to the covering of electrowinning cells with hoods with integrated extraction units, surfactants are sometimes added to minimise diffuse emissions of acid mists from cells.

Closed storage tanks and closed pipelines for transfer of solutions

Storage tanks are closed and equipped with an exhaust gas extraction system.

Electrolyte/solutions are transferred in fixed closed pipes.

Reduction of emissions to water by recirculation of solutions for reuse or recovery of metals

The bleed is treated for metal removal and returned to the electrowinning and/or the leaching process. Effluents that are not recirculated are treated in a waste water treatment plant (physical and chemical treatment). Acid waste water is generated by washing the cathodes and is partly reused to make up the right acid concentration.

Recycling of by-products (anode slime) for precious metals recovery

Anode slimes are used for precious metals recovery. Bleed electrolyte is purified to recover metals (Ni, As). Spent anodes are remelted for metal recovery

Prevention of soil/groundwater contamination by use of an impermeable and acid-resistant floor

The drainage systems are sealed and all solutions collected are recirculated.

Storage tanks/vessels are double-walled tanks or are placed in resistant bunds. The floor is impermeable and acid-resistant. Regular inspection and preventive maintenance of cells, tanks, pipes, pumps and cleaning systems are applied to ensure tightness and prevent leaks.

Scrubbers or demisters

Collected exhaust gases are treated in scrubbers or demisters.

Achieved environmental benefits

- Prevention and reduction of diffuse emissions to air and acid going into soil and groundwater.
- Efficient energy use (a current efficiency of > 95 % can be achieved). The use of stainless steel blanks results in improvement of the cathode quality, an increase in current efficiency and a low energy consumption, even with higher current densities.
- Recovery of metals.

Environmental performance and operational data

At KGHM (Głogów 1, 2 and Legnica), the refineries operate with copper starting sheets.

However, most electrolytic refineries (Atlantic Copper, Aurubis Hamburg, Olen, Pirdop and Lünen, Boliden Harjavalta and Rönnskär, Montanwerke Brixlegg, and Metallo-Chimique) use permanent stainless steel cathode plates. This system, in combination with controlled anode weight and physical anode preparation by machining, improves the geometry of the electrodes. As a result, the plant performance and the cathode quality are improved and a high degree of automation of the process can be achieved. The handling machines, e.g. for stripping, anode preparation and anode scrap washing machines, are fully automated.

The energy consumed by the electrorefining stage of copper production is reported to be 300–400 kWh per tonne of copper, but the energy used is higher when higher impurity anodes are electrorefined [134, Metallurgical Consulting Traulsen GmbH 1998]The type of blank cathode used (stainless steel or copper) mainly influences the efficiency of the tank house [90, Traulsen, H. 1998], and this can range from 92 % to 97 % in terms of current efficiency.

For heating, electrolyte heat exchangers operating with steam are used in electrorefining processes. The level of steam consumption depends mainly on the current density applied, the amount of cells covered, and how the ventilation of the tank house is arranged. Due to the higher voltage, the electrolyte of the electrowinning process requires cooling.

At Atlantic Copper in Spain, the washing machines for cathodes and anode scrap and the regulator cells are equipped with a ventilation system connected to a gas scrubber with a closed scrubber liquid circuit. Deeper decopperisation cells (these cells are called 'liberators') are enclosed and equipped with an arsane detection system. Copper refining cells are covered with plastic cloth to prevent the evaporation of water and to reduce energy consumption.

At Aurubis Hamburg and Olen, the storage tanks, cathode stripping, and anode scrap washing machines, as well as the regulator cells, are vented and the vent gases treated in a scrubber.

At Aurubis Lünen, the exhaust gas from ventilation of the handling machine and electrolyte purification is treated in demisters.

At Aurubis Pirdop, the partial and deeper decopperisation sections are equipped with local ventilation systems. Deeper decopperisation cells ('liberators') are completely enclosed and equipped with an arsane detection system. Washing machines used for cathodes and anode scrap are vented. The extracted gases are cleaned in demisters. Diffuse emissions of acid mists from regulating cells, as well as from the deeper decopperisation section, are collected by hoods and cleaned in scrubbers.

At Boliden Harjavalta, permanent cathodes are used. Cathode stripping and anode scrap washing machines are vented. Copper refining cells are covered with plastic cloth to prevent the evaporation of water and to reduce energy consumption. A heat recovery system is used to collect heat from the ventilation gases of the tank house. All decoppering cells are hooded. Arsane gas evolution in the last stage of decoppering is avoided by analysing and maintaining the copper concentration at the right level for the current density used in this stage. The same process is used at Boliden Rönnskär.

Over the last few years, several development and optimisation projects have been carried out at Montanwerke Brixlegg. The main project in the tank house was the conversion to a high current density tank house. By October 2007, the refining capacity had been increased to 108 000 tonnes of cathodes per year, by enlarging the tank house. Since autumn 2011, the capacity has been further increased to 118 000 tonnes of cathodes per year by using a high current density. In order to enable this high current density, half of the tank house has been equipped with a new transformer and with a manifold electrolyte inlet for parallel flow that allows the use of high current densities while maintaining a high current efficiency and good cathode quality. A current density of a maximum of 424 A/m^2 can be used in the high current density tank house.

All decoppering cells are covered and the off-gases are treated in demisters. Arsane gas occurrence in the last stage of decoppering is avoided by analysing and maintaining the copper concentration at the right level for the current density used in this stage.

At KGHM Głogów 1, 2 and Legnica, the refineries operate with copper starting sheets. The electrolytic cells are usually covered with fibre sheets. Off-gas from the evaporators in the electrolyte purification stage is treated in demisters (Głogów 2 and Legnica). In Głogów 1, vacuum evaporators do not emit gases.

At Metallo-Chimique Beerse, the refinery is designed to treat anodes with high amounts of impurities. The tank house uses the permanent cathode process. Covers on the cells are installed with integrated extraction.

At Umicore Hoboken, a leaching and electrowinning process is installed, in order to treat copper granulate with a high amount of impurities and with a very variable copper content produced at the ISASMELT furnace. Acid mist formation is prevented by adding a surfactant to the sulphuric acid. The electrical (current) efficiency is $> 95 \%$. A detection system continuously monitors the presence of arsane. The bleed is treated for metal removal and returned to the leaching and electrowinning process.

Leaching is done in closed vessels. The acid storage tank and the leaching reactors are vented and the extracted vapour ($30\,000 \text{ Nm}^3/\text{h}$) is treated in a scrubber with a sodium hydroxide solution, resulting in an output of 0.5 mg/Nm^3 of dust, 0.02 mg/Nm^3 of Cu and 0.2 mg/Nm^3 of H_2SO_4 . Acid waste water is generated by washing the cathodes and is partly reused to make up the right acid concentration, and partly sent to the waste water treatment plant for neutralisation.

At Cobre Las Cruces in Spain, an electrowinning process is installed in order to treat the copper sulphate solution produced from the hydrometallurgical solvent extraction process. A stripped solution containing mainly copper sulphate is pumped into electrowinning cells, where the copper is deposited on stainless steel cathodes and forms copper metal sheets (i.e. copper cathodes). There are 144 cells, with 84 cathodes per cell. Permanent cathodes are used, with an area of 1.15 m² per side.

Electrolytic cells are covered with cell hoods to prevent the acid mist spreading to the tank house atmosphere. Cell hoods are handled with tank house cranes and need to be temporarily removed from the cells whenever the cathodes are harvested or replaced. Each cell end is connected to the acid mist ducting, and off-gases are led to cascade-type wet scrubbers. Also, acid mists from the stripping machine wash chamber and electrolyte filters are led to the scrubbers. Each scrubber is designed to handle large gas volumes with an optimised pressure drop and a maximum separation efficiency. Approximately 95–98 % of the sulphuric acid and copper sulphate is recovered. These compounds are led out from the scrubber in otherwise clean spent washing water, and the solution can then be recycled back to the process. Final separation of the fine water droplets takes place in the cyclone-type separators. The cleaned off-gases containing less than 0.05 mg/m³ of sulphuric acid are blown with off-gas fans through the stack to atmosphere.

Cross-media effects

- Generation of acid waste water. Effluents that are not recirculated are treated in a waste water treatment plant (physical and chemical treatment).
- Increase in energy use.
- Use of additives (surfactants).

Technical considerations relevant to applicability

After the leaching processes, only electrowinning can be used for depleting copper out of the copper sulphate solution. Leaching, solvent extraction and electrowinning are preferred for inputs with a very variable composition and high amounts of impurities.

To keep the temperature of the cells to a workable level (around 65 °C), cells sometimes need to remain uncovered to favour direct heat transfer to atmosphere.

Economics

Investment costs of EUR 80 million were reported for the new copper refinery at Aurubis Pirdop (2008), with a projected production capacity of 180 000 t/yr.

For existing tank houses, the expense of conversion to stainless steel cathodes technology may not be appropriate.

Driving force for implementation

- Environmental regulation requirements.
- Reduction of energy consumption, increase in productivity, and minimisation of costs.

Example plants

- Electrorefining and electrowinning for bleed treatment: Aurubis Hamburg and Lünen (DE), Aurubis Pirdop (BG), Aurubis Olen (BE), Atlantic Copper Huelva (ES), Boliden Rönnskär (SE), Boliden Harjavalta (FI), Metallo-Chimique Beerse, Montanwerke Brixlegg (AT), KGHM Głogów 1, Głogów 2 and Legnica (PL).
- Electrowinning: Umicore Hoboken (BE) and Cobre Las Cruces (ES).

Reference literature

[238, ECI 2012], [383, Copper subgroup 2012], [150, J.A. Davis, W.R. Hopkins 1994], [134, Metallurgical Consulting Traulsen GmbH 1998], [297, Schlesinger. et al. 2011]

3.3.3.9 Sulphur dioxide removal from off-gases with a low SO₂ content in primary and secondary copper production

Description

The techniques to consider are:

- lime injection followed by a bag filter;
- polyether-based absorption/desorption process;
- flue-gas desulphurisation in a semi-dry or wet scrubber using calcium compounds to produce respectively calcium sulphite and gypsum;
- scrubbing with hydrogen peroxide; oxidation with hydrogen peroxide to produce sulphuric acid;
- scrubbing with sodium compounds;
- scrubber with Mg(OH)₂ and the crystallisation of magnesium sulphate;
- returning the gases to the process.

Technical description

The following techniques are applied to remove sulphur dioxide from off-gases with a low SO₂ content in primary and secondary copper production.

Lime injection followed by a bag filter

Lime is injected into the gas flow, causing the formation of calcium-sulphur compounds. Where possible, a simultaneous injection of water increases the reactivity of the lime, hence increasing the removal efficiency of the lime. The calcium-sulphur compounds and the process dust are removed from the gas flow by a fabric filter, which must have sufficient capacity for the additional dust load. The resulting mixture of lime and calcium-sulphur compounds can be reused in other metallurgical or water treatment processes. Lime injection can be combined with the simultaneous injection of other components, e.g. activated carbon for Hg or PCDD/F removal.

Polyether-based absorption/desorption process

This involves the selective physical absorption of sulphur dioxide from the washed and cooled stream of gas by a liquid polyether-based solvent capable of full regeneration. The main product is rich in SO₂ gas (~ 80 %), which is directed to the sulphuric acid plant. The purification is done without forming undesirable solid by-products. This technique is applied at the final desulphurisation of off-gases with a low SO₂ content from a single-conversion sulphuric acid plant and local power plant in a primary copper smelter (described in detail in Section 2.12.5.4.5).

Semi-dry or wet scrubber using calcium compounds

A slurry of the reactant 'lime milk' is injected into a reactor with the gas stream. The water is evaporated, provided the gas temperature is high enough, and the gaseous components react with the particles. The particles of the reacted reagent are then removed from the gas stream in a bag filter. The chemical reaction is:

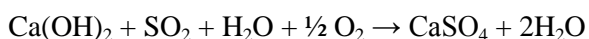
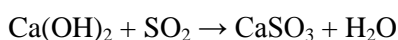

In the wet scrubber, the SO₂ off-gases go through a water suspension of limestone, leading after oxidation with air to the production of gypsum.

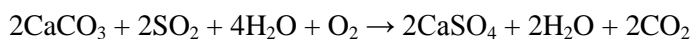

Scrubbing with hydrogen peroxide

The process uses hydrogen peroxide (H_2O_2) to oxidise SO_2 to sulphuric acid:

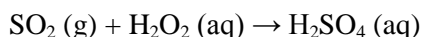

The scrubbing is achieved by direct contact in a co-current spray tower and a following countercurrent scrubbing tower. The concentration of the produced acid can reach up to 50 % H_2SO_4 , which can be recycled to the acid plant as a dilution agent or sold as a by-product if a market exists.

Scrubbing with sodium compounds

Sodium hydroxide is used as an absorption agent in the wet scrubber. According to the reaction formula: $\text{SO}_2 + 2\text{NaOH} + \text{O}_2 \rightarrow \text{Na}_2\text{SO}_4 + \text{H}_2\text{O}$, a solution of sodium sulphate is produced.

Na_2CO_3 is also used to react with SO_2 according to the following reaction:

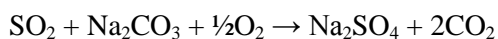

Scrubbing with $\text{Mg}(\text{OH})_2$

$\text{Mg}(\text{OH})_2$ is also used as an additive in the wet scrubber. After evaporation and crystallisation, magnesium sulphate is produced.

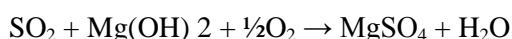

Returning the gases to the process

Dedusted ventilation gases with a low SO_2 content may be returned to the process as combustion air, to be finally desulphurised with the main gas stream.

Achieved environmental benefits

- Reduction of SO_2 emissions to air.
- Lime injection has a positive effect on the reduction of dioxin emissions. Dust and SO_2 removal are achieved with the same bag filter. The resulting solid mixture of lime and gypsum or lime and calcium sulphite, or gypsum itself can be reused in other metallurgical or water treatment processes.

Environmental performance and operational data

Lime injection followed by a bag filter

The desulphurisation efficiency of the dry or semi-dry scrubber is influenced by the temperature of the gases, the moisture content, and the contact time between lime particles and the gas. The turbulence of the gas flow, high specific surface of the lime particles and the quantity of lime also influence efficiency. A reactor chamber with sufficient residence time can be used to create a turbulent flow if there is space available, but direct injection of lime and water into the gas upstream of a fabric filter is used where there is not sufficient space for a reactor. A minimum temperature of 60 °C is needed for the process to operate effectively. The removal efficiency at a temperature of 150 °C and 5 % moisture content of the gas is about 45 %. When the moisture content increases to 25 %, the removal efficiency is increased to 75 %. At lower temperatures, the removal efficiency drops to 20–40 %, and high lime injection rates are needed. Where the gas temperature is close to the dew point, additional water injection is not possible because of the adverse effect on the bag filter.

At Aurubis Hamburg, the secondary fume collection system uses added lime injection in secondary hoods in the primary copper smelter. A system to inject lime milk ($\text{Ca}(\text{OH})_2$) into the gas flow was fitted to reduce the SO_2 present. For the SO_2 present in the gas flow with a concentration of 100–1500 mg/Nm^3 , 50–70 % is removed. Continuous measurements of SO_2 are

performed. The outlet SO₂ concentration was 50–1275 mg/Nm³ as a half-hourly average, and 95 % of the SO₂ values measured in 2011 were < 525 mg/Nm³ (see Section 3.3.3.6).

At Hoboken, Belgium, a newly designed batch process with a new gas-cleaning system is used, with varying SO₂ concentrations in the process gases. This applies a combined dust abatement and process dust removal system with injection of lime and water in a mixing chamber with a residence time of six seconds and the SO₂ concentration of the gases varies from 0 up to 1 %. The injection rate is +/- 250 kg/h at 150 °C and the moisture content 30 vol-%. Because of the metal content of the process dust, the flue-dust which is removed by the bag filter is reused in another process, and the gypsum can also be used in this process. Because of the lime injection, the filter capacity is 40 % higher than for only dust abatement. A test of dry lime injection in a cool gas showed a poor performance and high operating costs and the system was rejected.

Polyether-based absorption/desorption process

The polyether-based absorption/desorption process is applied for the final desulphurisation of off-gases with a low SO₂ content from a copper smelter (KGHM Legnica). See Section 2.12.5.4.5 for the final desulphurisation of off-gases from:

- a single-conversion sulphuric acid plant;
- a local power plant incinerating coal and shaft furnace gases containing CO and gases from the shaft furnace loading and tapping areas.

Semi-dry or wet scrubber using calcium compounds

Semi-dry or wet scrubbers using calcium-based sorbents incorporate suitable mixing and reaction chambers. Particles generated in the reaction chamber are usually removed in a bag filter or wet ESP. The partially reacted scrubbing medium is recycled to the reactor. The spent scrubbing medium is used in the main process, if possible. Semi-dry scrubbers incorporate a mist eliminator if mists are produced.

At KGHM Głogów 1, semi-dry desulphurisation with lime suspension is applied for SO₂ removal from the shaft furnace off-gases. The shaft furnace gases containing CO are incinerated in the local power plant, which is also fired with fine coal. The flue-gases are semi-dry desulphurised into the suspension of Ca(OH)₂. All of the water from the suspension evaporates, and dry product is collected in bag filters. The efficiency of the semi-dry desulphurisation plant is about 82 %.

At KGHM Głogów 1 and Głogów 2, semi-dry desulphurisation with lime suspension followed by bag filters is also applied for the anode furnace off-gas and the ventilation from the loading and tapping sections of the anode furnaces. Emission measurements are performed once a month. Levels of SO₂ are 20–200 mg/Nm³.

At Aurubis Pirdop, a wet scrubber with lime milk is applied to remove SO₂ from the gas stream containing the combined converter secondary gases, the converter roofline gases and the FSF taphole gases. SO₂ is measured continuously, directly in the stack. The range of daily average SO₂ values is 100–625 mg/Nm³ (the 90th percentile of the daily averages is 377 mg/Nm³) (see Section 3.3.3.6).

Scrubbing with hydrogen peroxide

At Aurubis Hamburg, the off-gas is captured by a secondary hood during the blowing and pouring operations of the primary copper converters (SO₂ content about 0.1 %, up to 2 %) and is either used for dilution of the technological gases processed in the sulphuric acid plant or is processed by the H₂O₂ treatment plant. The usual concentration of H₂SO₄ in this process is 30–35 %, to maintain a proper SO₂ absorption. The acid obtained can be used in the absorption section of the acid plant for dilution. The levels of SO₂ in the cleaned gas after the scrubber are in a wide range, 20–350 mg/m³ (daily average continuous measurements), because of the highly dynamic changes in SO₂ concentrations.

Scrubber with sodium compounds

At Atlantic Copper, Venturi scrubbers with Na(OH) followed by a wet electrostatic precipitator are applied for SO₂ removal from off-gases generated during fire refining. The collected solids are components of decomposed and unburnt natural gas, condensed metal and oxides; they are recycled to the process. SO₂ measurements are performed at least quarterly. Levels of SO₂ are below 200 mg/Nm³. A Venturi scrubber with a closed scrubber liquid circuit is also used to clean the gases from the electric slag furnace. Metals content in the solids are partially recovered. SO₂ measurements are performed quarterly. Levels of SO₂ are below 200 mg/Nm³.

At Aurubis Lünen, a scrubber with NaOH is used for SO₂ removal from the conversion stage off-gas. The TBRC off-gases (maximum design volume 70 000 Nm³/h) with a high SO₂ content, i.e. during maximum conversion stage, are led to the scrubber unit. The scrubber uses NaOH (50 % solution). The unit consists of a scrubber, NaOH storage tank and three tanks for intermediate scrubbing solution. Spent scrubbing solution is used in the KRS quench, i.e. it evaporates when cooling KRS off-gas, so that there is no waste water. The sulphur dioxide is transformed to sodium sulphate, which becomes part of the filter dust (KRS oxide) and is sold as a product. Continuous measurements are performed for SO₂. The levels of SO₂ are from < 50 mg/Nm³ to 1040 mg/Nm³ as a half-hourly average, from < 50 mg/Nm³ to 270 mg/Nm³ as a daily average and the 90th percentile daily average is 206 mg/Nm³.

At Głogów 2, there is a ventilation system at the tapping section of the direct-to-blister flash furnace. Gases (about 100 000 Nm³/h) are dedusted in a bag filter, into which some lime is blown to improve the dedusting process and to capture SO₂. The system is in operation during slag tapping. During copper blister tapping, an additional wet dedusting system – a Venturi scrubber with circulating Na₂CO₃ solution – is used. Discontinuous measurements of dusts and SO₂ are performed four times a year. Dust levels in the range of 3–5 mg/Nm³ are achieved. SO₂ is below 100 mg/Nm³.

At Głogów 2, Hoboken converters process Cu-Pb-Fe alloy obtained in an electric furnace used for flash furnace slag cleaning. The converter off-gas is handled in a dedicated wet cleaning system, consisting of a Venturi scrubber and a cyclone droplet separator. The circulated liquid agent is a solution of Na₂CO₃, which also ensures desulphurisation of the off-gas. The emitted gas contains 1–5 mg/Nm³ of dust, and below 200 mg/Nm³ of SO₂.

Scrubber with Mg(OH)₂

At Montanwerke Brixlegg, a scrubber with Mg(OH)₂ is used for SO₂ removal from off-gas from the converter furnace. The absorption medium used is a suspension of Mg(OH)₂ in water. The scrubber is used for the treatment of 30 000 Nm³/h of off-gas. The raw gas contains about 5–15 g SO₂/Nm³. This scrubbing system comprises three Venturi multivane absorbers set up in parallel, and these ensure a level of flue-dust filtering and desulphurisation down to 5–30 mg SO₂/Nm³ of clean waste gas in a lightly alkaline medium. The MgSO₄ produced in the scrubber is sold as an additive for construction purposes.

Returning the gases to the process

Some streams of ventilation gases may be utilised as process air, and are finally desulphurised as process gases.

At Głogów 1, ventilation gases from shaft furnace loading areas, having been dedusted in bag filters, are utilised as blow air in the shaft furnace. The ventilation gases from the shaft furnace tapping area are dedusted in bag filters and sent to the local power plant as combustion air (as described above).

At Legnica, all ventilation gases from the shaft furnace loading and tapping areas are dedusted in bag filters and utilised in the local power plant as combustion air (as described above). The loading, slagging and tapping sections of anode furnaces have ventilation systems in place, from which gas is used as air for combustion in the burner at the anode furnace or in the combustion chamber located between the anode furnace and the bag filter.

Cross-media effects

- Increase in energy use.
- Use of additives.
- Waste may be produced if the by-products obtained cannot be recycled (internally or by third parties) or recovered in another way.
- The H_2SO_4 produced from the scrubbing with hydrogen peroxide is not directly usable and should be led to the sulphuric acid plant. This further processing limits the applicability of the process (depending on the need for dilution in the sulphuric acid plant).
- Gypsum added to furnaces can result in the formation of SO_2 , which needs to be captured again.
- When wet systems are used, effluent water needs additional treatment to prevent the discharge of metals to water.

Technical considerations relevant to applicability

SO_2 capture by lime injection is applicable to treat off-gases from primary and secondary smelters, provided that appropriate process parameters are possible, i.e. temperature (minimum 60 °C), SO_2 content, variability of SO_2 content over the different process steps, and moisture content. For existing installations using a bag filter to clean the exhaust gases of a smelting furnace, direct lime injection is possible without retrofitting the existing abatement system when there is sufficient temperature, moisture content and contact time and the existing filter capacity can take the additional dust load. New installations can be designed to work at optimal conditions.

Scrubbers are applicable to new installations and for a major modernisation or plant upgrade. However, wet systems can only be applied if appropriate solutions can be provided for the water streams generated (disposal, disposal after treatment, or useful application). Effluents may contain up to 1.5 g SO_4 /l after the treatment of SO_4 -containing water streams with lime.

Economics

Generated by-products can be commercialised or reused. This is not always the case and depends on local market conditions and the quality specifications required. This can influence the combination of techniques applied. Also, the increase in investment costs (due to the additional equipment to be installed) and in operational costs due to the use of additives (lime, sodium hydroxide, H_2O_2 , etc.) has to be taken into account when deciding on the best techniques to be applied.

Lime injection

At Aurubis Hamburg, investment costs were EUR 10 million, plus approximately EUR 7 million for measures to capture diffuse emissions of the anode furnace and casting wheel.

Since the reaction of SO_2 with lime takes place at the surface of the particles, and the reaction proceeds faster at a higher moisture content, the lime consumption can be reduced by:

- simultaneous injection of water (steam) (higher energy cost);
- using lime with a higher specific surface (higher cost: lime costs range from EUR 60/tonne for calcium hydroxide to EUR 200/tonne for expanded calcium hydroxide);
- recirculation of the filter dust.

When the flue-dust must be disposed of, the cost of this technique can be very high.

NaOH scrubber

At Aurubis Lünen, an investment of about EUR 17.5 million was reported for environmental protection measures implemented within the scope of the KRS Plus project (crane-integrated hood, gas collection system, NaOH scrubber, and new bag filter).

H₂O₂ scrubber

Investment costs of EUR 4.5 million were reported by Aurubis Hamburg (2000–2007).

Operational costs for about 60 000–70 000 Nm³/h and up to 2 % SO₂ were EUR 1 million per year (2012).

Driving force for implementation

- Reduction of SO₂ emissions.
- The need to simultaneously reduce dust (by applying bag filters) and SO₂ favours the implementation of the lime injection technique.
- Spent scrubbing solutions can be used in the quench towers (i.e. evaporated by cooling the off the gases), reducing or eliminating the generation of effluent water.
- MgSO₄ produced can be sold as an additive for construction purposes.
- Gypsum produced could be used in metallurgical processes, and the excess lime that did not react could be used in the waste water treatment plant.

Example plants

Aurubis Hamburg and Lünen (DE), Montanwerke Brixlegg (AT), KGHM Głogów 1, Głogów 2 and Legnica (PL), and Atlantic Copper (ES).

Reference literature

[346, Eurometaux 2010], [238, ECI 2012],

3.3.3.10 Techniques to prevent and reduce emissions from the solvent extraction plant involved in hydrometallurgical copper production from concentrate or secondary materials

Description

Techniques to consider are:

- selection of process reagent and use of closed equipment such as closed mixing tanks, closed settlers and closed storage tanks;
- treatment of the purge from the solvent extraction process in the waste water treatment plant before discharge;
- treatment of the residues (crud) to recover the organic solution content;
- use of centrifugation for the treatment of the slurry from cleaning and settlers.

Technical description

Selection of process reagent and use of closed equipment such as closed mixing tanks, closed settlers and closed storage tanks

In the solvent extraction step, the emissions to air that could be produced are mainly diffuse emissions of VOCs from the storage, transfer and processing of the process streams. Using closed equipment such as closed mixing tanks, closed settlers and a closed storage tank feed in a closed circuit minimises the possible emission of VOCs. The minimisation of diffuse emissions can also be achieved by selecting a process reagent (solvent) with a lower steam pressure.

Treatment of the purge from the solvent extraction process in a waste water treatment plant before discharge

The principal liquid effluent generated in the solvent extraction stage is the secondary raffinate. This effluent originates from the bleeding and is required in the hydrometallurgical process to prevent impurities accumulating in the solvent extraction, leaching and electrowinning circuits. This effluent is sent to the waste water treatment plant, where metals are precipitated as hydroxides and sulphate. The resulting water flow is discharged into the receiving media.

Treatment of the residues (crud) to recover the organic solution content

A residue known as crud is generated in the solvent extraction step. Crud is a stable emulsion made up of suspended solids, aqueous solution and organic solution, and it forms in the phase between the organic and aqueous solutions in the solvent extraction settlers.

To remove the solids from the crud, this residue is sent to a treatment plant where the crud pulp is pumped from the settlers and passed through a clay filter to separate the solids fraction from the remaining phases. The slurry from the clay filter is circulated back into the crud collection tank (where the treatment starts) until the solution is free of solids. The phases are allowed to separate in the tank, with the aqueous and organic solutions taken separately from the tank. The aqueous solution is pumped to the primary raffinate after-settler, in order to recover the organic solution, which is returned to the loaded organic tank.

Use of centrifugation for the treatment of the slurry from cleaning and settlers

The slurry from cleaning the settlers (aqueous phase, crud and organic phase) is centrifuged to separate the solid from the liquid phase (solvent and water). This allows the recovery of solvent and water and reduces the quantity of solid residues. To avoid diffuse emissions, this installation is completely covered.

Achieved environmental benefits

- Minimisation of diffuse emissions.
- Recovery of solvent solution and water.

Environmental performance and operational data

At Cobre Las Cruces, the composition of the products used for the solvent extraction is designed to minimise the diffuse emissions of VOCs. Furthermore, the mixing tanks and settlers are closed.

The bleed is characterised mainly by a high heavy metal content, high sulphate concentration (mostly from adding sulphuric acid in the mineral leaching stage and from oxidation of the sulphides) and a very low pH.

Table 3.53 shows typical values for the principal parameters characterising secondary raffinate at Cobre Las Cruces under design conditions.

Table 3.53: Typical characterisation of secondary raffinate at Cobre Las Cruces

Parameter	Value
pH	0.5–1.5
Temperature	35–45 °C
Total organic carbon	2 mg/l
Total nitrogen	10.2 mg/l
Sulphide	5 mg/l
Sulphate	43 169 mg/l
Chloride	201 mg/l
Calcium	187 mg/l
Ferrous ion	5 678 mg/l
Ferric ion	5 976 mg/l
Cu	0.01–0.5 g/l
H ₂ SO ₄	16 g/l
<i>Source:</i> [358, CLC 2012]	

The secondary raffinate is sent to the neutralisation plant, where metals are precipitated as hydroxides and sulphate. The treated effluent is analysed at the exit of this waste water treatment plant before discharge into the receiving media.

The rate at which the crud forms is specific to each plant. In the case of Cobre Las Cruces, the pregnant leach solution feed contains high concentrations of iron, which constitutes one of the principal sources for the formation of crud. The crud is treated to separate the organic solution. The aqueous solution is pumped to the primary raffinate after-settler, in order to recover a possible organic solution, which is returned to the loaded organic tank.

The slurry from cleaning the settlers (aqueous phase, crud and organic phase) is treated in a centrifugation unit that comprises the following equipment:

- tanks to feed the centrifuge: two tanks each;
- pumps to feed the centrifuge;
- centrifuge to separate the mixture, comprising two liquids with different densities (organic and aqueous), and the solids contained in that mixture;
- tanks to collect the aqueous phase obtained from the tricanter;
- pump to recirculate the organic phase back to the process for reuse.

This installation is completely covered and located within the enclosed perimeter of the solvent extraction installation zone.

The slurry from cleaning and the settlers of the centrifugation unit of Cobre Las Cruces are treated. The process carried out is as follows:

- The feed tanks receive the crud to be treated after cleaning the settlers in the solvent extraction area with a solvent. The mixture to be separated is sent from these tanks to the tricanter through feed pumps.
- The tricanter performs the separation, on the one hand obtaining the aqueous phase which is sent to a collecting tank from where it is returned to the settlers with the aid of the corresponding pump. On the other hand, an organic phase is obtained which is also collected in a tank from where it is pumped to be reused and reintegrated into the solvent extraction process.
- Finally, the solid phase contained in the feed is separated from the tricanter and is collected in a container from where it will be removed for disposal as a plant residue.

Cross-media effect

No information provided.

Technical considerations relevant to applicability

Generally applicable

Economics

No information provided.

Driving force for the implementation

- Minimisation of diffuse emissions.
- Recovery of the solvent solution.

Example plants

Cobre Las Cruces (ES).

Reference literature

No information provided.

3.3.4 Secondary copper production

A broad variety of secondary materials are used in secondary copper production and they are characterised by variable copper content and a broad concentration range of other metals or they are complexed with other elements (e.g. metallic, oxidic, sulphidic). Also, waste containing copper and other metals can be treated, e.g. electronic scrap. The input materials have to be appropriate for the process used though.

The following processes are applied depending on the input materials:

- ISASMELT furnace, for the smelting and converting to blister copper of a wide range of primary and secondary copper/lead-containing materials (dusts, mattes, dross, slags, anode slimes, etc.), electronic scrap and some raw materials containing zinc and waste;
- KRS, for the smelting and converting to blister copper of secondary copper materials such as copper alloy scrap, electronic scrap, copper-rich slags, copper dross, flue-dust, sludges;
- electric furnace, for smelting a wide range of copper, and copper/lead-containing materials with an oxidic, sulphuric or metallic nature, i.e. dusts, dross, slags, low-grade precious metals containing anode slimes, copper alloy scrap, low-grade matte, copper/lead concentrates;
- mini smelter and blast furnace, for smelting secondary oxidic and metallic copper-containing materials, using iron or copper/iron scrap as a reducing agent;
- TBRC, for the smelting of copper and copper alloy scrap, slag and complex concentrates;
- Contimelt, which is a continuous two-stage process, for melting and treating black and blister copper, high-grade copper scrap, and anode scrap to produce copper anodes (see Section 3.3.3.6).

The Ausmelt/ISASMELT furnace and KRS may apply an intermittent two-stage smelting and converting process in the same installation, thus preventing supplementary emissions arising from the transfer of materials from one furnace to another.

The production of copper from secondary raw materials has become more energy-efficient over the years with the introduction of newer techniques. The energy consumption of the KRS installation is 1080 kWh/t of raw material, which is considerably lower than the old system of blast furnace, converter and lead-tin alloy plant at 2300 kWh/ [234, UBA (D) 2007]

3.3.4.1 Techniques to prevent and reduce emissions to air from smelting furnaces in secondary copper production

Description

The techniques to consider are:

- use of feed materials according to the furnace and the abatement system installed;
- operation under negative pressure, encapsulated furnaces/charging systems, appropriate housing, enclosures, use of covered launders, secondary hoods with efficient extraction (and subsequent dedusting and gas-cleaning systems);
- use of a boosted suction system;
- treatment of off-gas (primary and secondary):
 - cyclones in combination with bag filters,
 - double contact/double absorption acid plant, liquid SO₂ plant, scrubber, dry lime/Sorbalit injection, addition of adsorbents, mercury removal systems, afterburning, quenching.

Technical description

Use of feed materials according to the furnace and the abatement system installed

Emission prevention is achieved by the correct design of the furnace and the emission abatement system and by using the correct raw materials according to the design criteria.

Pretreatment of the feed materials is also used to achieve the required process specifications, such as fine and sludge-type feed materials being pelletised or alternatively mixed or dried and pneumatically injected. Other pretreatments, like decoating or de-oiling, might be applied, depending on the presence of organic materials (see Section 3.3.2.2).

Operation under negative pressure, encapsulated furnaces/charging systems, appropriate housing, enclosures, covered launders, secondary hoods with efficient extraction

Sealed charging systems (such as double bell, door sealing, closed conveyors and feeders), and sealed or enclosed furnaces can be applied. Operation under negative pressure and with a sufficient gas extraction rate is applied to prevent pressurisation of the furnace.

Furnaces are encapsulated in vented housing, or enclosures are used. Extraction systems such as hoods are applied to capture fumes at furnace charging and tapping sections. The effectiveness of collection depends on the efficiency of the hoods, the integrity of the ducts, and on the use of a good pressure/flow control system. The use of an Ausmelt/ISASMELT furnace or KRS can prevent emissions from the transfer of materials from one furnace to another, as these furnaces can apply an intermittent two-stage smelting and converting process in the same installation.

Use of a boosted suction system

Adjustment of the extraction rates to the actual requirements is possible by application of variable speed fans, as is an automatic adjustment of the exhaust system to the charging conditions. Automatic controls are used for dampers to achieve good extraction and to target the extraction effort to the source of the fumes without using too much energy. The controls enable the extraction point to be changed automatically during different stages of the process. Variable speed fans are used to provide extraction rates that are suitable for the changing conditions. Systems to operate the fans, valves and dampers automatically to ensure optimal collection efficiency and prevent diffuse emissions are also applied.

Continuous or regular monitoring of the performance of the entire extraction system, and regular inspection and preventive maintenance of the furnaces, hoods, ducts, fans and filter systems are applied to ensure airtightness and prevent fugitive releases.

Treatment of off-gas

The content of secondary smelter off-gases (primary and secondary) depends on the composition of the raw materials/fuels used. To reduce the emissions, thermal destruction of TVOC and dioxins can be achieved in the furnace by gas temperatures higher than 950 °C. Reformation of dioxins is prevented by rapid gas cooling (quenching or waste heat boiler). A bag filter is used for dust and metals; in some cases, in combination with activated carbon injection which also reduces the emissions of VOCs, PCDD/F and mercury. Secondary gases may be treated together with process off-gases. The separated dusts are recycled internally or externally for metal recovery.

Primary off-gases emitted from secondary smelters can contain sulphur dioxide, depending on the composition of the input material and the process in use (e.g. coke, which is needed for the blast/shaft furnace). Off-gases with high SO₂ concentrations from furnaces processing sulphur-containing materials are treated in a double contact/double absorption process unit for sulphuric acid production or a liquid SO₂ plant. Before entering these processes, the process gases can be roughly dedusted in a dry hot ESP and, after cooling and washing, a second time in a wet ESP. Heat can be recovered in a waste heat boiler, where steam is generated for use in other processes or for building heating purposes.

At the secondary electric furnace, off-gas is afterburnt, cooled, filtered in a bag filter and treated in a mercury removal plant, before entering the acid plant without additional washing and cooling.

For off-gases with a low SO₂ content, sulphur dioxide removal can be achieved by injection of lime into the bag filter (see Section 3.3.3.9).

Mercury removal systems using absorbents or other techniques described in Section 2.12.5.5 are applied.

Adsorbents (e.g. active coal) are added in the filter systems if necessary to abate dioxins and other VOCs, or other techniques could be applied (see Sections 3.3.4.1.2 and 3.3.4.1.3).

The separated dusts are recycled internally or externally for metal recovery.

Secondary off-gases are dedusted in a bag filter if necessary with lime or other additives.

In Sections 3.3.3.9, 3.3.4.1.1 and 3.3.4.1.3 the techniques to consider for the prevention and the reduction of SO₂, PCDD/F and NO_x emissions are described. Section 3.3.4.1.2 deals with the use of a RTO.

Achieved environmental benefits

- Reduction of dust and metals emissions to air.
- Reduction of SO₂ emission to air and recovery of sulphur.
- Reduction of PCDD/F and VOC emissions.
- Recovery of raw material, through the reuse of abated dust.
- Recovery of energy using the waste heat boiler.

Environmental performance an operational data

At Aurubis Hamburg, an enclosed electric furnace is charged via closed belts and a sealed lift charging system. The top of the furnace is placed under enclosure. Fine and sludge-type feed materials are pelletised. The furnace primary off-gas is cooled with recirculated cold gas and by an air-to-gas cooler. After cooling, the off-gas is filtered in a bag filter and sent through a mercury absorption unit. There, after condensing, adsorbents are added. Additional mercury is removed using a selenium-containing absorber. Off-gas is then transferred to a double contact/double absorption acid plant if it contains substantial SO₂, or to the stack if only a low SO₂ content is to be reduced. Hoods capture the secondary gases during tapping. The head of the furnace is completely under a hood. Secondary gases from the electric furnace are collected, and are dedusted in a bag filter. Continuous measurements are performed for dust and SO₂. Dust levels of 0.5–5.5 mg/Nm³ (half-hourly average) and < 0.5–4.2 mg/Nm³ (daily average) are reported. SO₂ emissions levels are 50–840 mg/Nm³ (half-hourly average) and 50–340 mg/Nm³ (daily average). Variations of SO₂ concentrations are due to the batch-wise operation of the slag and metal tapping. Data represent long-term normal operation under different conditions, such as variability of input material, various loads and operating regimes, abrasion of equipment, and wear of filter elements. The separated dusts are recycled internally or externally for metal recovery.

At Aurubis Lünen, the KRS furnace is sealed effectively. The charging systems are enclosed and provided with an off-gas capture system. The tapholes are equipped with hoods and off-gas capture systems. The KRS furnace off-gases are cooled in a WHB and cleaned together with the secondary gases (hoods) in a bag filter system. The off-gas flow from the furnace including secondary hoods with a flow of around 500 000 Nm³/h and a dust content of 5000–10 000 mg/Nm³ is treated in five bag filters.

Continuous measurements are performed for dust, SO₂, NO_x, HCl, HF and Hg. Dust levels of < 0.5–5.2 mg/Nm³ (half-hourly average) and < 0.5–2.7 (daily average) are reported, while the 90th percentile of the daily average is < 0.5 mg/Nm³. Levels of SO₂ of < 50–1520 mg /Nm³

(half-hourly average) and $< 50\text{--}303 \text{ mg/Nm}^3$ (daily average) are reported. Levels of $0.0037\text{--}0.09 \text{ mg/Nm}^3$ (half-hourly average) and $< 0.01\text{--}0.05 \text{ mg/Nm}^3$ (daily average) are reported for mercury. Concentrations show very high variations due to the batch-wise operation. Minimum and maximum values are also highly influenced by the input material of each batch.

At Umicore Hoboken, the ISASMELT furnace operates batch-wise with a copper/lead input, producing blister copper and a lead oxide slag. The blister copper is further treated in a refining furnace and granulated into copper granules. High percentage oxygen enrichment is applied in order to reduce the amount of process gases. The ISASMELT smelter operates under negative pressure. Primary off-gases are afterburnt at $1000 \text{ }^\circ\text{C}$, cooled in a waste heat boiler with steam generation and then further cooled by water injection and evaporation. Then the gases are dedusted in a hot ESP with five fields. After quenching and further washing, dedusting in a wet ESP, and cooling, they are transferred to a double contact/double absorption acid plant with a SO_2 release of $< 300 \text{ mg/Nm}^3$.

Secondary gases are aspirated at the feed port, lance port, tapholes and refining furnace with dedicated hoods; they are cleaned in a bag filter with a capacity of $230\,000 \text{ Nm}^3/\text{h}$; the gases are released to the atmosphere with less than 1 mg/Nm^3 of dust, less than 300 mg/Nm^3 of SO_2 , and less than $0.01 \text{ ng I-TEQ/Nm}^3$ of dioxins.

At Metallo-Chimique Beerse, the mini smelter furnace is encapsulated to capture dust emissions. Off-gases are treated in a bag filter with a capacity of $100\,000 \text{ Nm}^3/\text{h}$. After dedusting, the gas stream is treated in an adsorption filter, to capture dioxins and other volatile organic chemicals. Dust measurements are performed once a month. Dust levels of $< 5 \text{ mg/Nm}^3$ can be maintained. SO_2 is measured continuously and is below $< 500 \text{ mg/Nm}^3$ as a daily average.

A TBRC is also used at Metallo-Chimique. The primary off-gases pass through an air-to-gas cooler and cyclone before passing the bag filter ($70\,000 \text{ Nm}^3/\text{h}$) with Sorbalit injection. A secondary bag filter ($70\,000 \text{ Nm}^3/\text{h}$) is installed to clean the emissions from the encapsulation of the furnace. Levels of dust between 0.5 mg/Nm^3 and 2 mg/Nm^3 can be maintained. SO_2 is measured continuously. The final dust emissions are monitored continuously by triboelectrical measurement.

At Elmet Berango, the mini smelter is encapsulated to capture dust emissions. Off-gases are treated in a bag filter with a capacity of $120\,000 \text{ Nm}^3/\text{h}$. The secondary gases are treated in a bag filter with a capacity of $55\,000 \text{ Nm}^3/\text{h}$.

At Montanwerke Brixlegg, the off-gas from the shaft furnace (flow rate around $50\,000 \text{ Nm}^3/\text{h}$) is treated for dust removal in a bag filter. The organics contained in the gas are destroyed by a regenerative afterburner. Loading and tapping sections of the shaft furnace are equipped with ventilation systems, and exhaust fugitive gas is cleaned in a bag filter. Levels of dust of $0.5\text{--}1.8 \text{ mg/Nm}^3$, of SO_2 of $0.2\text{--}86 \text{ mg/Nm}^3$, of HCl of $2.1\text{--}1.5 \text{ mg/Nm}^3$, of HF of $0\text{--}12.3 \text{ mg/Nm}^3$, and of CO of $0\text{--}11 \text{ mg/Nm}^3$ (all as averages of three half-hourly measurements) are reported.

At Boliden Rönnskär, a TBRC furnace is used for melting electronic scrap to black copper. Lead concentrates are also processed in the same furnace. Process gases from the TBRC Kaldofurnace are treated in a liquid SO_2 plant and double contact/double absorption acid plants. The process is encapsulated and the ventilation gases ($44\,000 \text{ Nm}^3/\text{h}$) are treated in a bag filter. Continuous measurements are performed for dust and SO_2 . Levels of $< 5 \text{ mg/Nm}^3$ for dust and $< 500 \text{ mg/Nm}^3$ for SO_2 are reported. NO_x is measured once a year and is below 200 mg/Nm^3 . PCDD/PCDF are measured once a year. Levels below $0.05 \text{ ng I-TEQ/Nm}^3$ are reported.

Table 3.54: Operational and performance data for secondary smelting (part 1)

Company	Aurubis Hamburg	Umicore Hoboken		Aurubis Lünen
Furnace type	Electric furnace	ISASMELT furnace		KRS
Furnace capacity	13.5 MW	100 t/h charge		25–50 t/h Oxygen enrichment 25 %
Feed	Dusts, dross, slags, low-grade precious metals containing anode slimes, copper alloy scrap, low-grade matte, copper/lead concentrates and other copper/lead-bearing materials	By-products from copper, lead, zinc production, complex concentrates, end-of-life products containing precious metals		Copper and copper alloy scrap, electric and electronic scrap, copper-rich slags, copper dross, filter and cyclone dust, slimes, sludges, copper iron materials
Off-gas treatment	Secondary (primary emissions are routed to the SAP)	Primary	Secondary	Primary + secondary hood
	Furnace roof enclosure, hoods at tapholes, Bag filter	WHB, evaporative cooler, hot ESP, double contact/double absorption acid plant	Hoods and ventilation at tapholes, launders and ladle stands, Bag filter	WHB, bag filter with injection of special adsorbents for Hg and HF
Max. flow rate (Nm ³ /h)	185 000	75 000	270 000	500 000
Emission levels (mg/Nm³)				
Monitoring frequency	Continuous	3 times per year (3–5 hours)	11 times a year (3–5 hours)	Continuous
Dust	0.5–5.5 (half-hourly average) 0.5–4.2 (daily average)	0.02–0.44 0.44 (90 th percentile)	0.12–0.33 0.23 (90 th percentile)	0.5–5.2 (half-hourly average) 0.5–2.7 (daily average)
Monitoring frequency	Continuous	Continuous	11 times a year (3–5 hours)	Continuous
SO ₂	50–840 (half-hourly average) < 50–340 (daily average)	55–246 (daily average) 125 (90 th percentile - daily average)	3–383 143 (90 th percentile)	50–1520 (half-hourly average) 50–303 (daily average)
Monitoring frequency	4 times per year (3*30 min)	3 times per year (3–5 hours)	Twice a year (3–5 hours)	Once every 3 years (6*30 minutes)
Cu	0.01–0.2	0.003–0.046	0.002	0.03–0.04
Pb	0.01–0.2	0.003–0.046	0.001–0.004	0.01–0.1
As	0.01–0.02	0.0002–0.09	0.0012–0.0018	0.01
Hg	Not reported	0.008–0.018	Not reported	0.0037–0.09 < 0.01–0.05 ⁽¹⁾
Cd	< 0.02	< 0.004	0.0002–0.0009	0.01
Ni	< 0.01–0.1	< 0.036	Not reported	0.01

Monitoring frequency	Not applicable	Twice a year	Once a year	Once every 3 years (3*6 hours)
PCDD/F	Not reported	0.001	0.004	0.04–0.08
Monitoring frequency	Not applicable	Once a year (2 hours)	Once a year (2 hours)	Once every 3 years (6*30 min)
TVOC	No information provided	2	2	7–40
Monitoring frequency	Not applicable	9 times per year (1–4 hours)	4 times per year (1–4 hours)	Continuous
NO_x	Not reported	64–168	4–20	2–55 (daily average)
<p>(¹) Continuous measurement, daily average. NB: Metal emissions largely depend on the composition of the raw materials used, the type of process and the efficiency of the dust filtration system.</p>				

Table 3.55: Operational and performance data for secondary smelting (part 2)

Company	Elmet		Metallo-Chimique	Montanwerke Kovohuty	Montanwerke Brixlegg
Furnace type	Mini smelter		Mini smelter	Blast shaft furnace	Blast shaft furnace
Furnace capacity	Not reported		Not reported	Not reported	Not reported
Feed	Copper-containing ashes, residues, and slags, Low-grade copper-containing metallic scrap		Copper-containing ashes, residues, and slags, Low-grade copper-containing metallic scrap	Oxides with a copper content of about 10–70 % are melted with slags, coke, silica and ferrous materials (shredder copper, Cu-Fe material)	Dust, ashes, slag, irony copper
Off-gas treatment	Primary	Secondary	Primary + secondary treated together	Primary + secondary (ventilation system loading and tapping section) treated together	Primary + ventilation systems loading and tapping section
	Bag filter	Bag filter	Cooler, cyclone, bag filter, adsorption filter with Sorbalit injection	Secondary hoods with bag filter	Bag filter, Quench regenerative afterburner (RTO)
Max. flow rate Nm ³ /h	120 000	50 000	75 000	25 000	50 000
Monitoring frequency	Continuous	Continuous	Twice a year (4 hours)	Once a year (3*30 minutes)	Continuous ⁽¹⁾ Once every 3 years ⁽²⁾
Dust	1.7–3.9 (half-hourly average) 2.5 (yearly average)	14.6 maximum peak of half-hourly average 1.5 (yearly average)	0.5	1.5–19.5 13.5 average	3 ⁽¹⁾ (daily average) 0.5–1.8 ⁽²⁾ (3*30 minutes)
Monitoring frequency	Twice a year (30 minutes)	Twice a year (30 minutes)	Continuous	Once every 3 years (5*30 minutes)	Once every 3 years (3*30 minutes)
SO ₂	3–60	0–17	80 (yearly average) 140 (90 th percentile of hourly averages)	30–85	0.2–86

Monitoring frequency	Once a year (30 minutes)	Once a year (3*30 min)	Twice a year (4 hours)	Once every 3 years (5*30 minutes)	Once every 3 years (3*30 minutes)
Cu (mg/Nm³)	0.16–0.4	0.15–0.2	0.002–0.007	Aggregated data were reported	0.0005–0.0175
Pb (mg/Nm³)	0.029–0.05	0.036–0.064	0.0015–0.03		0.0039–0.012
As (mg/Nm³)	Below LOD	0–0.017	Below LOD		0.0005–0.001
Hg (mg/Nm³)	0–0.004	0–0.004	Not reported		0.006–0.056
Cd (mg/Nm³)	0.007–0.014	0.007–0.01	0.0005–0.001		0.0001–0.003
Ni (mg/Nm³)	0.005–0.007	0.003–0.005	Below LOD		0.0001–0.001
Monitoring frequency	Once a year	Once a year	Twice a year (6 hours)	Not applicable	Once every 3 years (3*3 hours)
PCDD/F (ng I-TEQ/Nm³)	0.05	0.05	< 0.005	Not reported	0.293–0.564
Monitoring frequency	Once a year (30 minutes)	Once a year (30 minutes)	Not applicable	Once every 3 years (5*30 minutes))	Once every 3 years (3*30 minutes)
TOC	4–10	0–1	Not reported	12–56 16 average as TVOC	0.1–1.2 as organic C
Monitoring frequency	Twice a year (30 minutes)	Twice a year (30 minutes)	Not applicable	Once every 3 years (5*30 minutes)	Once every 3 years (3*30 minutes)
NO_x	2–22	0–22	Not reported	10–20	87
NB: Metal emissions largely depend on the composition of the raw materials used, the type of process and the efficiency of the dust filtration system. Source: [378, Industrial NGOs 2012]					

Cross-media effects

- Increase in energy use.
- Use of additives, like lime, activated carbon and others to remove SO₂, dioxins and mercury.
- Waste may be produced if the collected dust cannot be returned to the process or reused.

Technical considerations relevant to applicability

The techniques are applicable to new and existing secondary copper plants, depending on the type of raw material.

The applicability of the wet scrubber may be limited in the following cases:

- very high off-gas flow rates, due to the cross-media effects (significant amounts of waste and waste water);
- in arid areas by the large volume of water necessary and the need for waste water treatment and the related cross-media effects.

Recovery of the high SO₂ concentration in the off-gas in a double contact/double absorption acid plant is predominantly applied for furnaces processing secondary sulphur-containing materials or a combination of secondary materials and primary concentrates. Other SO₂ removal techniques are applied for off-gases with a low SO₂ content (see Section 3.3.3.9). The use of techniques to reduce mercury will depend on the type of feed.

Economics

The capital cost of the KRS installation was EUR 40 million, using the existing filter units and stack [234, UBA Copper, lead, zinc and aluminium 2007].

At Aurubis Hamburg, the investment costs for the installation of a mercury removal plant were up to EUR 5 million (including condenser, heaters, bag filter, injection system, absorber and fans).

The investment costs for a bag filter can be estimated at EUR 10/m³ of cleaned air. The investment costs for the cleaning of more complex impurities than dust, e.g. in desulphurisation plants, scrubbers, afterburners, are tenfold. The working costs per year can be estimated at between EUR 0.001/m³ and EUR 0.01/m³ depending on the techniques used and the costs for electricity.

Driving force for implementation

- Environmental regulation requirements.
- Energy and raw material savings.

Example plants

Aurubis Hamburg and Lünen (DE), Umicore Hoboken (BE), Metallo-Chimique Beerse (BE), Elmet Berango (ES), Montanwerke Brixlegg (AT), and Boliden Rönnskär (SE).

Reference literature

[238, ECI 2012], [383, Copper subgroup 2012]

3.3.4.1.1 Reduction of PCDD/F emissions by using primary and secondary measures in secondary copper production

Description

The techniques to consider are:

- selection of raw materials according to the furnace and the abatement techniques used;
- optimum combustion conditions;
- charging systems which give small additions of raw materials in semi-closed furnaces;
- thermal destruction of dioxins in the furnace at high temperatures (> 850 °C);
- oxygen injection in the upper zone of the furnace;
- avoiding exhaust systems that lead to high dust loading at temperatures of > 250 °C;
- post-combustion chamber or afterburner;
- rapid quenching of off-gases in the temperature range between 400 °C and 200 °C;
- injection of adsorption agent (e.g. activated carbon, lignite coke, lime) before dedusting;
- efficient dust collection system.

Technical description

For the technical description of these techniques see Section 2.12.5.3.

The organic carbon compounds that can be emitted include PCDD/F, resulting from the incomplete combustion of synthetic or mineral organic materials (oil, plastic, etc.); or in some cases halogens in the feed material and from the de novo synthesis if the gases are not cooled rapidly enough.

It is possible to identify organic and/or halogen contamination of secondary raw material, so that the most appropriate furnace and abatement combination can be used to prevent the emissions of PCDD/F.

Scrap pretreatment to remove organic contamination can be practised where necessary, depending on the particular furnace or process used.

Improvement of combustion conditions includes the use of enriched air or pure oxygen, and enhanced or improved mixing of oxygen with combustible material, leading to an increased combustion temperature or residence time at high temperatures. As a consequence, the VOCs are oxidised, including PCDD/F.

Modification of furnace charging systems is applied to give small, even additions of raw materials in semi-closed furnaces. This reduces furnace cooling during charging, and maintains higher gas temperatures, which can help to optimise the process and prevent the de novo synthesis of PCDD/F.

The thermal destruction of dioxins can be achieved in the furnace at gas temperatures greater than 850 °C and with sufficient residence time. Prevention of dioxin reformation is then achieved by rapid gas cooling down to 200 °C. Afterburners can also be used to treat the gases produced, followed by rapid cooling. In cases where it is not possible to treat the gases from the furnaces in an afterburner, they can be oxidised by adding oxygen above the melting zone.

PCDD/F can be adsorbed onto an activated carbon in a fixed bed or moving bed reactor or by the injection of activated carbon or other additives into the gas stream, with subsequent removal as filter dust. The quantity and composition of the additive depends to a large extent on process conditions and the origin and composition of the input materials.

High-efficiency dust filtration can assist the capture of dust and ensure the removal of dioxins which are sometimes absorbed.

Achieved environmental benefits

Prevention and reduction of PCDD/F emissions.

Environmental performance and operational data

Copper acts as a catalyst in the dioxin formation. This implies that smelting secondary raw materials with even a low organics and chlorine content may result in higher quantities of dioxins in the raw off-gas than can be expected in the production of other non-ferrous metals.

The level of PCDD/F emitted with the off-gas also depends on the specific process parameter (due to the high reducing potential of the shaft furnace the development of dioxins is greater than in other furnaces) and the specific off-gas conditions (e.g. temperature, residence time at the different temperature windows, SO₂ content).

At Aurubis Lünen, the KRS is designed for the thermal destruction of dioxins, which may *inter alia* arise during smelting, and for the prevention of their de novo synthesis by rapid cooling of the waste gas leaving the waste heat boiler at temperatures of 600 °C. PCDD/PCDF are measured once every three years (three samples, six-hour measurements). Measured values are between 0.01 ng I-TEQ/m³ and 0.1 ng I-TEQ/m³.

At Aurubis Hamburg, the thermal destruction of dioxins is achieved in the electric furnace at high temperatures (above 950 °C). The prevention of dioxin reformation is ensured by rapid gas cooling. Further treatment in an acid plant also avoids the formation of dioxins.

At Aurubis Olen, a lime and active coal system has been installed before the bag filters in order to abate the dioxin emissions. The preselection of scrap to minimise the quantity of potential precursor or organic material is also practised. Measurements of PCDD/F are performed three times a year (six-hour measurements). Measured levels are in the range of 0.03–0.5 ng I-TEQ/Nm³ (for a Contimelt plant, melting and refining blister copper, high-grade copper scrap and anode scrap) and 0.026–0.25 ng I-TEQ/Nm³ (for a Contirod plant, processing copper cathodes and high-purity scrap to produce wire rod).

At Boliden Rönnskär, the off-gases of the TBRC furnace are quenched, then lime and activated carbon are injected, and the gases are dedusted in a bag filter. PCDD/F are measured once a year, and levels below 0.05 ng I-TEQ/Nm³ are reported.

At Umicore Hoboken, regular checks are carried out on incoming raw materials for their dioxin content. Dioxins in raw material are destroyed in the ISASMELT furnace or in the post-

combustion. A rapid quenching of the gases avoids the formation of new dioxins; the reaction in the contact catalyst beds also avoids the formation of new dioxins. All measurements at the sulphuric acid plant stack are below 0.001 ng I-TEQ/Nm³.

At Montanwerke Brixlegg, the organics contained in the gas are destroyed by a regenerative afterburner. The concentration of PCDD/F in the off-gases from the shaft furnace has been progressively reduced to 0.31 ng I-TEQ/Nm³.

At Metallo-Chimique Beerse, the mini smelter furnace is equipped with a separate end-of-pipe adsorption filter with Sorbalit injection. Sorbalit is a combination of lime with activated coal. At the furnace mouth, an afterburner is installed. The end-of-pipe adsorption filter has a capacity of 100 000 Nm³/h. PCDD/F are measured twice a year for six hours each. Levels of < 0.1 ng I-TEQ/Nm³ are maintained.

The TBRC furnace is equipped with a bag filter (70 000 Nm³/h) with Sorbalit injection to clean primary off-gases. PCDD/F are measured twice a year for six hours each. Levels between 0.01 ng I-TEQ/Nm³ and 0.1 ng I-TEQ/Nm³ are maintained.

Cross-media effects

- Collected dust may have high PCDD/F concentrations and may need to be disposed of or treated carefully when being returned to the production process.
- Use of additives/adsorbents.
- Increase in energy use (afterburner).

Technical considerations relevant to applicability

Generally applicable. The optimum combination of the techniques applied in new and existing copper plants depends on the type of raw material and furnace used.

Economics

In order to reduce the costs of adsorbents, filter dust can be returned to the process.

Driving force for implementation

Environmental regulation requirements.

Example plants

Aurubis Hamburg and Lünen (DE), Aurubis Olen (BE), Umicore Hoboken (BE), Metallo-Chimique Beerse (BE), Montanwerke Brixlegg (AT), and Boliden Rönnskär (SE).

Reference literature

[238, ECI 2012], [383, Copper subgroup 2012]

3.3.4.1.2 Reduction of emissions from furnaces by using a regenerative afterburner in secondary copper production

Description

The technique to consider is the use of a bag filter and RTO.

Technical description

Volatile organic compounds (VOCs) and residual CO can be undesirable impurities in the furnace off-gas from secondary copper production. A combination of afterburners, cooling systems and dust emission abatement systems can be used to remove these impurities from furnace off-gases.

The installation of an afterburner provides excess oxygen, high temperatures (> 850 °C) and enough residence time to decompose and burn all organic carbon from the gas stream and to technically destroy organic compounds, including PCDD/PCDF (i.e. dioxins and furans). The

gases are then quenched to avoid the reformation of dioxins and furans, or if applicable cooled for heat recovery and sent through a bag filter for dedusting.

Regenerative thermal oxidisers (RTOs) employ a regenerative system to utilise the heat energy of the flue-gas. This system uses a bed of ceramic materials, which absorbs heat from the flue-gas. The captured heat preheats the incoming process gas and destroys the organic compounds. Before entering the RTO, the off-gases are dedusted in a bag filter. Autothermal operation is achieved in certain circumstances and no additional heating gas is then needed.

Achieved environmental benefits

Reduction of CO, VOC and PCDD/F emissions.

Environmental performance and operational data

At Montanwerke Brixlegg, the off-gas stream is sucked from the shaft furnace and blown under pressure into the regenerative afterburner unit. A frequency-controlled fan is designed to catch the smoke and off-gas from the furnace, which is blown afterwards into the RTO. The dust filtered off-gas is blown into the RTO at 110 °C. Within the RTO, the off-gas is treated by ceramic towers and heated up to 950 °C by a natural gas burner, supported by the latent heat of the gas itself. In this way organic compounds, including dioxins, are oxidised and CO is also oxidised to CO₂.

After the bag filter, the VOC content is controlled. The gas flow and CO emissions are continuously monitored in the stack for volume, dust and CO. The monitoring station for the shaft furnace is downstream of the thermal afterburning unit and before the run-in to the chimney. The RTO is a three-chamber type with ceramic used as the generative material. The natural gas burner is a mid-speed burner with a maximum gas flow of 80 m³/h. The off-gas itself has a mean retention time of 1.5 seconds within the RTO. The maintenance interval is every six months.

The CO and dust in the off-gas stream are monitored permanently, and the data are stored on the internal server. Dust and CO are continuously recorded and logged.

The total amount of PCDD/F is below 0.3 ng/m³, and the oxidation of the CO is effective, with a value of 25 mg/Nm³ as a daily average reported based on continuous measurement, whereas for spot measurements emissions from 0.19 mg/Nm³ to 11 mg/Nm³ (half-hourly average) are reported. For dust emissions, continuous measurement shows a value of 3 mg/Nm³ as a daily average and values from 0.5 mg/Nm³ to 1.8 mg/Nm³ for spot measurements (half-hourly average).

Cross-media effects

The RTO needs to be fired with natural gas.

Technical consideration relevant to applicability

The technique is applicable to furnaces with high residual PCCD/F and CO concentrations.

Economics

The operational costs of the RTO are mainly linked to the operation of the shaft furnace, from which the off-gas is treated. The amount of natural gas is determined by the thermal conditions necessary for the oxidation of the organic compounds within the off-gas.

Driving force for implementation

- Environmental regulation requirements.
- RTO energy consumption is about 75 % lower than for the recuperative afterburner.

Example plants

Montanwerke Brixlegg (AT).

Reference literature

[238, ECI 2012], [249, Austria, Brixlegg 2007], [383, Copper subgroup 2012]

3.3.4.1.3 Reduction of NO_x emissions from furnaces by using primary and secondary measures in secondary copper production

Description

The techniques to consider are:

- use of pure oxygen for combustion (oxy-fuel burners);
- use of oxygen enrichment under specific conditions;
- supplying an inert gas.

Technical description

The formation of NO_x during combustion is determined by temperature and the partial pressure of N₂ in the gas phase. Since pyrometallurgical processes require high temperatures, measures to reduce NO_x emissions are usually based on the reduction of the partial pressure of N₂. This can be achieved by using pure oxygen instead of air for combustion.

The use of oxygen enrichment of the air may also have an adverse effect though, by locally increasing the combustion temperature. This could promote the formation of NO_x and therefore this should be checked carefully.

Also, the intake of 'false' air in the combustion (hot) zone will promote the formation of NO_x and should be avoided or minimised.

Energy savings are possible, as it is not necessary to heat the atmospheric nitrogen to the process temperature.

Supply of an inert gas reduces the production of nitrogen oxides. Such an inert gas, e.g. exhaust gas, can be partly directed back into the combustion chamber. The rapid oxidation of fuel molecules is inhibited by the presence of these gas molecules. Additionally, the retention time of reactants should be as short as possible.

Achieved environmental benefits

- Prevention of NO_x emissions.
- Reduction of flue-gas, due to lower combustion gas volume.
- Reduction of energy use.

Environmental performance and operational data

Typical levels for the emissions of nitrogen oxides for secondary copper are reported to be in the range of 20 mg/Nm³ to 400 mg/Nm³, depending on the furnace and type of operation.

The use of pure oxygen in a burner results in a reduction in the nitrogen partial pressure in the flame compared to the use of air, and therefore thermal NO_x formation may be reduced. This may not be the case with oxygen enrichment in or near the burner, or if there is significant leakage of air into the furnace, as the higher gas temperature may promote thermal NO_x formation. In the latter case, oxygen can be added downstream from the burner to reduce this effect and maintain the improvement in the melting rate.

Emission levels of nitrogen oxides for secondary copper production vary depending on the furnace geometry and type of operation, as well as on the type of fuel, the construction of the burner, the combustion sequence and the rate of heat release and heat transfer. For NO_x, the use of highly efficient processes (e.g. Contimelt) requires a balance to be established locally between energy use and achieved value.

The presence of ambient air in the furnace should also be taken into account. It is difficult to avoid the intake of ambient air in many cases. In order to achieve this, the furnace should be completely closed or be operated at an overpressure (though this can cause diffuse emissions).

In Table 3.56, data related to NO_x emissions are shown.

Table 3.56: Emissions and operational data for NO_x emission in copper production

Production site	Emissions source	NO _x range (mg/Nm ³ as NO ₂)	Comment
Aurubis Lünen, DE	Anode furnace	0–625 (half-hourly average) 280 (95 th percentile of half-hourly average) 0–171 (daily average)	Oxygen enrichment of combustion air Continuous measurement
Aurubis Lünen, DE	KRS furnace	0–467 (half-hourly average) 105 (95 th percentile of half-hourly average) 0–54 (daily average)	Oxygen enrichment of combustion air Continuous measurement
Aurubis Lünen, DE	TBRC furnace	0–260 (half-hourly average) 150 (95 th percentile of half-hourly average) 0–102 (daily average)	Oxygen enrichment of combustion air Continuous measurement
Aurubis Olen, BE	Contimelt process	178–700	Oxy-natural-gas burners Discontinuous measurement, once a month (1*60 min)
Montanwerke Brixlegg, AT	Blast furnace	45 (half-hourly average)	Oxy-fuel burner (in gas inlet area)
Montanwerke Brixlegg, AT	Converter	10 (half-hourly average)	Oxy-fuel burner (front main burner)
Montanwerke Brixlegg, AT	Anode furnace (cover burner)	50–200 (half-hourly average)	Oxy-fuel burner (cover burners)
<i>Source:</i> [383, Copper subgroup 2012], [385, Germany 2012]			

Cross-media effects

Higher off-gas temperatures decrease the durability of the refractory lining.

Technical considerations relevant to applicability

Oxy-fuel combustion can be applied to most pyrometallurgical processes. The techniques applied depend on the furnace geometry and type of operation, as well as on the type of fuel, the construction of the burner, the combustion sequence and the rate of heat release and heat transfer. The techniques are valid provided that no ambient air is present in the furnace. The full benefit is achieved when the design of the combustion chamber and abatement systems can take

into account the lower gas volumes. This can be done for new plants/installations or for retrofitted existing plants/installations.

Economics

The economic advantages of oxy-fuel burners are mainly related to improvements in terms of production rate and the reduction of energy costs (as abatement systems can be kept smaller).

Driving force for implementation

- Reduction of emissions.
- Energy savings.
- Potentially shorter melting time due to the higher temperature of the burner flame.

Example plants

Aurubis Lünen (DE), Aurubis Olen (BE), and Montanwerke Brixlegg (AT).

Reference literature

[238, ECI 2012], [383, Copper subgroup 2012]

3.3.4.2 Techniques to prevent and reduce emissions to air from holding furnaces in secondary copper production

Holding furnaces in secondary copper production are used to allow the continuous processing of molten metal (e.g. black copper, converter copper, blister copper) and to achieve an appropriate separation of metal and slag.

Holding furnaces are located after smelting furnaces or converters, for the storage of molten metal or slag awaiting further processing and refining in other devices. This ensures a proper, smooth production flow with sufficient capacity for molten metal and at lower operational costs. This time period in holding furnaces allows for the further separation of black/converter copper from slag.

Holding furnaces are typically horizontal drum types, charged via a launder/channel or ladle. The furnaces can use different fuels (fuel oil, natural gas), as well as oxy-fuel burners to maintain the necessary melting temperature.

Description

The techniques to consider for the reduction of emissions from holding furnaces are:

- enclosed furnace;
- capture hoods or crane-integrated hoods at charging and tapping points;
- enclosure or housing of the receiving ladle;
- tertiary fume collection, such as 'house-in-house';
- holding temperatures in the furnaces at the lowest required level;
- gas extraction systems at charging and tapping areas;
- negative pressures in the furnace and flue-gas route;
- flue-gas cooling and bag filters.

Technical description

Prevention and collection techniques are described in Section 2.12.4.3.

Holding furnace off-gas and secondary ventilation gas are cooled and dedusted in bag filters (see Section 2.12.5.1.4).

Achieved environmental benefits

Prevention and reduction of dust emissions.

Environmental performance and operational data

At Montanwerke Brixlegg, the molten black copper is separated from the slag in the shaft furnace. The black copper runs in a bricked channel into the holding furnace. The holding furnace is a horizontal drum-type with a fireproof, lined interior. The diameter is 4.1 metres and the length 8.25 metres. The circulation of the copper melt within the holding furnace is achieved by an ascending flushing gas (mainly air, hence mostly N₂) which diffuses through porous purging plugs. To keep the necessary melting temperature, natural gas is fired with a burner from the side with a capacity of 1.2 MW. The black copper is further manipulated with a crane and ladles into the converter. During the manipulation, the off-gas, as well as smoke gas from the holding furnace, is sucked by an induced draught fan into a bag filter. For the holding furnace, natural gas is used (~ 500 000 m³/yr). The tilting engine of the holding furnace is powered by electricity. The holding furnace is used approximately 240 days a year, processing 15 kt of black copper. The dust and off-gas measurement units of the holding furnace are located in a vertical circular lead waste gas pipe with an exit face of 900 mm². The off-gas stream is monitored permanently, with the data stored on an internal server. The diffuse and direct emissions from the process are cleaned (dedusted) in a bag filter. The average dust emission values are about 2 mg/m³.

At the Aurubis Hamburg north plant converter, the black copper from the electric smelting furnace is transferred to a holding furnace before further converting. The holding furnace is inside a closed building and additionally accommodated in a largely sealed enclosure, which is vented to a filter system (house-in-house containment system). Charging/tapping operations mainly occur within this enclosure, which is equipped with an indoor crane. The charging trolley for transport of the ladles is vented (e.g. by whirl hoods) (see Section 3.3.4.4, 'House-in-house' containment system).

At Aurubis Lünen, the molten black copper and slag from the KRS are tapped into holding furnaces. The holding furnaces are enclosed. Diffuse emissions during charging and tapping are collected by hoods and the ventilation system. The receiving ladle is under enclosure. Off-gases from the holding furnaces are treated together with KRS secondary gases (see Section 3.3.4.1). Converter metal from the TBRC can also be transferred to a holding furnace before further refining. The holding furnace, together with the TBRC, is located in a separate enclosed building from which the air is exhausted and cleaned in an off-gas filter unit. Charging and discharging operations are done with a crane which has an integrated hood to capture the associated fumes. The hood is connected with the off-gas and filtering facilities by means of a belt system. The holding furnace off-gases are captured by the hood and cleaned in the bag filter together with TBRC off-gas (see Section 3.3.4.3).

Cross-media effects

Increase in energy use (e.g. for fans and bag filter).

Technical considerations relevant to applicability

Generally applicable. A crane-integrated hood is applicable only for new or completely rebuilt installations. House-in-house techniques are suitable for reducing diffuse emissions from the tapping and charging of furnaces.

Economics

At Montanwerke Brixlegg, the consumption of natural gas for the holding furnace is 500 000 m³/yr.

Driving force for implementation

Environmental regulation requirements.

Example plants

Montanwerke Brixlegg (AT), Aurubis Hamburg and Lünen (DE).

Reference literature

[238, ECI 2012], [383, Copper subgroup 2012]

3.3.4.3 Techniques to prevent and reduce air emissions from converter furnaces in secondary copper production

The converting stage for secondary copper production uses Peirce-Smith converters and TBRCs operated batch-wise. PS converters process liquid copper/lead matte, copper-rich slags in some cases, or black copper, with the addition of solid copper scrap or electronic scrap, and other copper/lead or materials containing low-grade precious metals. Input materials for scrap PS converters include alloy scrap, suitable Cu-Fe scrap, and black copper. A TBRC is applied for the processing of black copper and copper and copper alloy scrap.

The Ausmelt/ISASMELT furnace and KRS are also used for an intermittent two-stage smelting and converting process (see Section 3.3.4.1).

Description

The techniques to consider are:

- encapsulated furnaces;
- operation under negative pressure and boosted suction system;
- housing and enclosures;
- primary and secondary hoods and the addition of scraps/fluxes through the hood;
- crane-integrated hood for charging and tapping;
- tertiary fume collection, such as 'house-in-house', with an efficient extraction system;
- cooling systems with a bag filter or ESP;
- SO₂ removal systems.

Technical description*Diffuse emissions prevention and gas collection*

Operation of the converter relies on negative pressure and the use of primary and secondary or tertiary fume collection hoods. Dusts, fluxes and scrap can be added through the hood. The TBRC is compact and is enclosed, allowing collection of the secondary fumes. Automatic controls can prevent blowing during the periods that the converter is 'rolled out'.

Converters can be equipped with secondary hoods to collect diffuse emissions close to the emission source during charging or tapping. The suction is provided directly at the source of the fumes to reduce diffuse emissions. Automated systems are used to operate the fans automatically in process stages that produce fumes. Variable speed fans are also used. Roof ventilation of the smelter hall is applied if appropriate.

Gases that are not collected by the secondary hoods can be collected in a tertiary collection system that encloses the whole operating area such as a house-in-house system (see Section 3.3.4.4). A crane-integrated hood is also used as an effective new device to reduce emissions from the charging and tapping of secondary converter furnaces, e.g. TBRCs.

Off-gas treatment

Off-gases from the converters in secondary copper processes are treated by gas cooling (with heat/energy recovery if possible), coarse particle separation, dust removal in an ESP or by a bag filter, and for SO₂ removal.

The techniques applied for SO₂ removal are connected with the raw materials used and are a double contact/double absorption acid plant (see Section 2.12.5.4.1), Mg(OH)₂ wet scrubber, NaOH scrubber or other applicable techniques (see Section 3.3.3.9).

Secondary gases are treated in a bag filter. Lime injection can be applied if SO₂ emissions are relevant.

Achieved environmental benefits

- Reduction of dust, metals and SO₂ emissions.
- Reduction of diffuse emissions.
- Flue-dust can be returned to the process or recycled externally.
- Spent scrubbing solution (NaOH scrubber) is used in the KRS quench where evaporation takes place so no fresh water is used.

Environmental performance and operational data

At Aurubis Lünen, the TBRC furnace is used for converting black copper. It is located in a separate enclosed building from which the air is exhausted and cleaned in a filter unit. All fumes from charging and discharging operations are collected by a newly designed crane-integrated hood, and in addition by the roof ventilation of the smelter hall. The hood is connected with the off-gas and filtering facilities by means of a newly developed belt system. The ventilation off-gas (crane-integrated hood, smelter hall and holding furnace) maximum design volume is 230 000 Nm³/h. The TBRC furnace off-gases (70 000 Nm³/h) are captured by another hood and cleaned in a separate filter. TBRC off-gas with a high SO₂ content (arising during the maximum conversion stage) is cleaned in an NaOH scrubber to reduce SO₂ emissions (see Section 3.3.3.9).

Continuous measurements are performed for dust, SO₂, NO_x, HF and HCl. Levels of dust are from < 0.5 mg/Nm³ to 0.8 mg/Nm³ (half-hourly average), and < 0.5 mg/Nm³ (90th percentile of daily average values). The levels of SO₂ are below 270 mg/Nm³ as a daily average (the 90th percentile of daily average values is 206 mg/Nm³). NO_x emissions are < 50–250 mg/Nm³ (half-hourly average); 50–100 mg/Nm³ (daily average), (the 90th percentile of daily average values is 60 mg/Nm³). Concentrations show very high variations due to the batch-wise operation. Minimum and maximum values are also highly influenced by the input material of each batch.

The KRS (see Section 3.3.4.1) is also suitable for the converting step.

Aurubis Hamburg operates one small PS converter for the conversion of copper matte or copper/lead matte to blister copper. The converter off-gases are cooled, coarse particles are removed in a dust chamber, and afterwards the gas is dedusted in electrostatic precipitators and transferred to the double contact/double absorption acid plant. Secondary gases from the converter area are collected and dedusted in several bag filters, with lime injection. The converter is provided with capture hoods and additionally accommodated in a largely sealed enclosure which is vented to a filter system, e.g. house-in-house containment system. All pouring and transfer operations occur within this enclosure, which is equipped with a trolley crane (charging trolley) for this purpose. The crane and converter movements are remote-controlled. Continuous measurements are performed (secondary gas) for dust and SO₂. Levels of 0.5–10 mg/Nm³ for dust and 50–1425 mg/Nm³ for SO₂ are reported as half-hourly average values. High SO₂ content arises when the converter is moved out of the primary hood for charging or tapping.

At Boliden Rönnskär, the same Peirce-Smith converter is used as for the primary copper production (see Section 3.3.3.3).

A TBRC is used at Metallo-Chimique Beerse. The primary off-gases pass through an air-to-gas cooler and cyclone before going to a bag filter (70 000 Nm³/h) with Sorbalit injection. A secondary bag filter (70 000 Nm³/h) is installed to clean the emissions from the encapsulation of the furnace.

At Montanwerke Brixlegg, black copper is treated in a PS converter furnace together with copper alloy scrap, brass slag, bronze and red brass. The off-gas is treated by a Mg(OH)₂ wet scrubber for SO₂ removal. The MgSO₄ produced is sold as an additive for construction

purposes. The converter furnace is also equipped with nitrogen scourers. The converter section is equipped with a ventilation system (45 000 m³/h), the exhaust gas is cleaned in bag filters. Emissions are 2.1–5.9 mg/Nm³ for dust (half-hourly average, discontinuous measurement) and 5–30 mg/Nm³ for SO₂ (half-hourly average, discontinuous measurement) and 0–3.2 mg/Nm³ for HF (half-hourly average, discontinuous measurement).

The operational data are summarised in Table 3.57.

Table 3.57: Operational and performance data for secondary converters

Company	Aurubis Lünen	Aurubis Hamburg	Metallo-Chimique Beerse	Montanwerke Brixlegg
Feed	Black copper, alloy scrap	Copper matte (molten or solid), copper/lead matte, copper-rich slags, black copper, solid copper scrap or electronic scrap and other copper/lead or materials containing low-grade precious metals	Black copper, copper and alloy scrap/material	Black copper, alloy scrap, brass slag, bronze and red brass
Furnace type	TBRC* (120 t/charge)	PS converter	TBRC (120–160 t/charge)	PS converter
Primary gas treatment	Cooling, bag filter and NaOH scrubber	Dust chamber, ESP, washing and cooling, double contact/double absorption acid plant (see also Section 2.7.2)	Cooler, cyclone, bag filter with Sorbalit injection	Bag filter + wet scrubber Mg(OH) ₂
Max. flow rate (Nm³/h)	70 000	See Section 2.7.2	62 000	40 000
Parameter	Emission levels (mg/Nm³)			
Monitoring frequency	Continuous	Not applicable	Twice a year (4 hours)	Continuous** Discontinuous***
Dust	< 0.5–0.8 (half-hourly average) < 0.5 (daily average) < 0.5 (90 th percentile daily average)	Not relevant	< 0.5–1.3 0.9 (yearly average)	3 (daily average**) 2.1–5.9 (every 3 years 3x0.5 hours***)
Monitoring frequency	Continuous	Continuous	Continuous	Continuous** Discontinuous***
SO₂	< 50–040 (half-hourly average) < 50–270 (daily average) 206 (90 th percentile daily average)	330–1980 (half-hourly average) 270–1080 (daily average) See also Section 2.7.2	494 (yearly average based on daily average) 664 (90 th percentile daily average)	30 (daily average**) 5–30 (every 3 years 3x0.5 hours***)
Monitoring frequency	6 times per year (30 minutes)	Not applicable	Twice a year (4 hours)	Every 3 years (3*30 min ***)
Hg	0.001–0.009	Not relevant	Not reported	Not reported
Cu	Not reported		0.0016–0.02	0.0035
Pb	0.003–0.009		0.0023–0.0026	0.002

As	Not reported		< 0.0005	0.0002
Cd	0.001–0.017		< 0.0005–0.0012	< 0.0001
Monitoring frequency	6 times per year (6 hours)	Not applicable	Twice a year (6 hours)	Every 3 years (6 hours)***
PCDD/F ng I-TEQ/Nm ³	0.01–0.06	Not relevant	0.015–0.019	0.0009–0.0115
Secondary gas collection sources	Roof ventilation of smelter hall Crane-integrated hoods	House-in-house containment system	Converter secondary hood	Ventilation, part of centralised system (see Section 3.3.4.4)
Secondary gas treatment	Bag filter	Bag filter with lime injection	Bag filter	Bag filter
Max. flow rate (Nm ³ /h)	230 000	250 000	67 000	150 000
Monitoring frequency	Continuous (secondary gas emitted together with primary off-gas, see data above)	Continuous	Twice a year (4 hours)	Continuous** Discontinuous***
Dust	See data above	< 0.5–10 (half-hourly average) 0.8–2.7 (daily hour average) 2–4 (yearly average)	< 0.5	2 (daily average**) 1.2–5 (every 3 years 3x0.5 hours***) daily average
Monitoring frequency	Continuous (secondary gas emitted together with primary off-gas, see data above)	Continuous	Not measured	Not measured
SO ₂	See data above	< 50–1425 (half-hourly average) 65–250 (daily hour average) 100–200 (yearly average)	Not measured	Not measured
Monitoring frequency	See data above	4 times per year (3*30min)	Twice a year (4 hours)	Every 3 years 3*30min***)
Cu	See data above	< 0.01–0.23	0.0008–0.0028	0.06
Pb		0.01–0.3	0.0009–0.0032	0.04
As		< 0.01–0.07	< 0.0005	0.0013
Cd		< 0.01–0.02	< 0.0005	0.0005

* The TBRC furnace in Aurubis Lünen is newly commissioned and still under optimisation, therefore only preliminary data are available.
** Values refer to continuous monitoring.
*** Values refer to discontinuous monitoring.
NB: Metal emissions largely depend on the composition of the raw materials used, the type of process and the efficiency of the dust filtration system.
Source: [378, Industrial NGOs 2012] [385, Germany 2012]

Cross-media effects

- Increase in energy use.
- Wet gas cleaning systems (scrubbers) may generate slurry and additional waste and waste water that require treatment.

- Use of lime or other additives for SO₂ removal.

Technical considerations relevant to applicability

Bag filters are applicable to new and existing installations. Scrubbers are applicable for new installations and when a major modernisation or upgrade of existing installations is carried out, as slurry generation and additional waste water treatment measures have to be taken into account.

Recovery of SO₂ in a double contact/double absorption acid plant is predominantly applied for matte secondary converters that are installed in primary copper production sites, as these are equipped with sulphuric acid production units. A crane-integrated hood is applicable only for new or completely rebuilt installations.

The house-in-house technique is applied to reduce emissions from the tapping and charging of furnaces.

Economics

Capital expenditure for the 'house-in-house' system was reported as up to EUR 6 million.

At Aurubis Lünen, investment costs of about EUR 17.5 million were reported for environmental protection measures implemented within the scope of the TBRC project (including crane-integrated hood, gas collection system, NaOH scrubber, and new bag filter).

Driving force for implementation

Environmental regulation requirements.

Example plants

Aurubis Lünen and Hamburg (DE), Metallo-Chimique Beerse (BE), Montanwerke Brixlegg (AT), and Boliden Rönnskär (SE).

Reference literature

[238, ECI 2012], [383, Copper subgroup 2012]

3.3.4.4 Techniques to prevent and reduce secondary air emissions from auxiliary devices in secondary copper production

Description

The techniques to consider are:

- secondary hoods to capture fumes from tapping, casting and transfer operations;
- furnace enclosures or tertiary fume collection such as 'house-in-house';
- extraction systems with automatic operation of fans and subsequent off-gas cleaning in bag filters or scrubbers.

Technical description

Fumes from charging points, tapholes, casting facilities, launders and ladle stands are collected by capture hoods, and exhaust gases are cleaned in a bag filter.

Wet gases, e.g. from granulation, are captured by hoods and a wet scrubber is used before they are released to the atmosphere.

The house-in-house concept is an elaborate technology. The units (holding furnace, converters and casting facilities) installed inside closed production buildings are not only provided with capture hoods, but are additionally accommodated in a largely sealed enclosure which is vented to a filter system. All pouring, casting and transfer operations mainly occur within this enclosure, which is equipped with a trolley crane (charging trolley) for this purpose. The crane, casting devices and converter movements are remote-controlled, so that the operating personnel

are not exposed to the fumes. Ladle transfer of the molten materials is accomplished by motorised cable-operated trains, which are also remote-controlled. In this way, diffuse emissions from the filled ladles during transfer from the converter to the holding furnace are effectively trapped by tornado hoods.

Diffuse emissions from pouring or charging the furnaces are captured either by primary hoods or by the house-in-house enclosure (see Figure 2.2). The off-gases of the house-in-house system are cleaned in a bag filter with lime injection and are discharged to atmosphere via a stack.

A computer system is used to operate the fans automatically when process stages that produce fumes are operated. The house-in-house concept uses this principle to prevent excessive energy consumption.

Achieved environmental benefits

- Reduction of diffuse dust and SO₂ emissions.
- Dusts are returned to the processing stages or sold to third parties to recover valuable metals.
- Reduction of dust emissions from the secondary smelter converter hall by 75 % by applying the house-in-house technique eliminates the need to install a building ventilation system. Workplaces are no longer located in the immediate vicinity of emission sources, thus contributing to better occupational health and safety.

Environmental performance and operational data

The house-in-house concept is applied at the secondary smelter at Aurubis Hamburg. Continuous measurements are performed for dust and SO₂. Dust levels of 0.5–10 mg/Nm³ (half-hourly average) and 0.8–2.7 mg/Nm³ (daily average) are reported. SO₂ levels of 50–1425 mg/Nm³ (half-hourly average) and 65–250 mg /Nm³ (daily average) are reported. Data represent long-term normal operation under different conditions like variability of input material, loads and operating regimes, and abrasion of equipment and wear of filter elements. High SO₂ content arises when the converter is moved out of the primary hood for charging or tapping.

At Umicore Hoboken, diffuse gases from tapholes, launders and ladle stands are collected; the vent gases captured are cleaned in a bag filter with a capacity of 230 000 Nm³/h; the gases are released to atmosphere with less than 1 mg/Nm³ of dust. The wet fumes from the granulation process of the impure copper are scrubbed and effectively dewatered, resulting in a dust content of < 5 mg/Nm³.

At Montanwerke Brixlegg, the loading and tapping sections of the shaft furnace, the holding furnace, the converter and the anode furnace are equipped with ventilation systems for fume collection and centralised cleaning in a bag filter (160 000 Nm³/h). On each of the stacks at the Brixlegg site, continuous dust measurements are carried out. For dust, the average is around 3 mg/Nm³.

Cross-media effects

- Use of lime or other additives for SO₂ removal.
- Treatment of flue-dust is required to remove impurities before reusing the dust.

Technical considerations relevant to applicability

Generally applicable. The house-in-house technique is applied to reduce emissions from the tapping and charging of furnaces and casting for new installations or during a major upgrade of an existing installation.

Economics

Capital expenditure for the 'house-in-house' system was reported as up to EUR 6 million.

Driving force for implementation

- Environmental legislation requirements.
- Reduction of diffuse emissions and recovery of raw materials.
- The off-gas volume to be extracted and cleaned in the house-in-house concept is lower compared to regular building ventilation systems, and thus the energy requirements are considerably lower.

Example plants

Aurubis Hamburg (DE), Umicore Hoboken (BE), and Montanwerke Brixlegg (AT).

Reference literature

[238, ECI 2012], [383, Copper subgroup 2012]

3.3.5 Copper processing

3.3.5.1 Techniques to reduce emissions from melting and casting for the production of copper and copper alloy formats, ingots and wire rods

Wire rod is manufactured from high-purity copper cathodes, copper scrap or low alloyed copper through continuous processes, such as the Contirod process, the SCR (Southwire Continuous Rod) process or upwards casting processes.

Copper and copper alloyed shapes (billets and cakes), strips and ingots are mostly produced in continuous casting, semi-continuous casting or in ingot casting processes.

Description

Techniques to consider are:

- selection and feeding of raw materials according to the furnace and the abatement techniques used;
- application of integrated moisture control to prevent emissions to air;
- use of encapsulated equipment, hoods, enclosures or coverage;
- afterburner or activated carbon injection with a filtration system;
- bag filter;
- heating the feed materials and/or the combustion air with the shaft furnace flue-gases;
- use of indirect cooling systems or a water-cooling closed circuit;
- reuse of the rolling processes' emulsion.

Technical descriptions

The melting of copper and copper alloys takes place in different types of furnace depending on the casting process and the raw materials. The furnaces are either fuel-heated (shaft furnaces or rotary furnace) or electrically heated (induction furnaces or heat resistivity furnaces).

Shaft furnaces are used for melting copper cathodes and other pure copper scrap material for wire rod and for shapes or strip production. These furnaces are usually heated by natural gas burners. Electric furnaces are used to melt copper alloys and also pure copper.

A degree of melting and fire refining can be carried out to adjust the alloy composition in crucible-shaped furnaces or rotary furnaces.

Holding furnaces are applied after the melting furnace. In these furnaces, the melt is conditioned and homogenised with regards to temperature and composition. The holding furnace can be heated by fuel or electrical heat, or a combination of both. In some cases, melting and holding are performed in one furnace.

Molten metal is transferred by heated launders or ladles from furnace to furnace, or from furnace to casting unit.

Selection and feeding of raw materials according to the furnace and the abatement techniques used

The application of the following process-integrated measures prevents emissions into air.

- Inputs of sorted or pretreated scrap (lower impurity levels, largely free of cooling lubricants, compacted scrap, pelletised chips). For production purposes, the classification of EN 12861:1999 is normally used.
- Depending on the furnace type, the input of scrap with a lower moisture content (e.g. use of prepared chips, predrying or thermal treatment).
- Observing the charging order and then feeding material to the melting unit as consistently as possible.
- Controlled feeding of single piece cathodes (e.g. Upcast process).
- Ensuring that chips are directly immersed in the melt when using induction furnaces, and adhering to a suitable charge regime when charging the shaft furnace.
- Maintaining a controlled fuel to air ratio of the combustion gas, based on the furnace type and operating conditions

Application of integrated moisture control to prevent emissions to air

- Regulating the temperature of the melt to prevent it from overheating.
- Use of advanced controls for the gas to oxygen ratio of a shaft furnace to optimise combustion.

Use of encapsulated equipment, hoods, enclosures or coverage

Diffuse emissions from copper and copper alloy melting facilities can arise under melting conditions, as well as, depending on the material composition, during decanting, deslagging, casting, and from pans and channels.

Several techniques can be applied to capture off-gases and optimise the process by adjusting the extraction volume flow to the respective process accordingly, including the following:

- Induction furnaces may have capture devices integrated in the furnace roof, which ensure off-gas capture under all operating conditions (charging, melting, unloading). Certain technologies (e.g. the Upcast process) have a low level of emissions which may not require an exhaust system, as these minimise the exposed melt surface by using special hoods with small openings.
- For shaft furnaces and rotary furnaces, off-gas capture is integrated into the furnace construction. Shaft furnaces capture the waste gases at the top of the furnace. Rotary furnaces capture the off-gas through the exhaust opening at the opposite side to the burner. Using a closed lift charging system for the shaft furnace. Charging the rotary furnaces through the exhaust port.
- Emissions resulting from the casting of copper alloys can be captured by suction hoods or partial enclosures or suction rings adjusted to the launders, holding furnace or casting channels, where possible, in accordance with the casting process requirements. Movable hoods that can be swivelled over the source of emissions can also be used.
- Covering the rolling stands (partially) and pickling line for integrated forming processes like wire rod production.
- Covering the melts in holding and casting furnaces, for example, with special salts, charcoal or soot providing the quality of the product is not affected.
- Optimising the gas capture by adjusting the extraction volume flow to the respective process.

Off-gas treatment

Captured off-gases are directed to a bag filter or cyclones followed by bag filters to reduce the dust content. It may be necessary to cool the off-gas to the appropriate filter inlet temperature beforehand. Hot off-gases from furnaces can be rapidly cooled/quenched to below 250 °C to avoid PCDD/F formation. This occurs by injecting water into the off-gas stream as soon as possible after capturing the off-gases.

The off-gases from thermal chips preparation and the shaft furnace can be thermally post-combusted if materials with high contents of organic substances (oils, cooling lubricant) are used.

Dioxins and furans in the off-gas can also be precipitated with the dust removal process. Sorption agents (such as activated coals) could be added prior to the filter.

When brasses or bronzes are melted, zinc and zinc oxides are fumed from the furnace, but a good level of control of the furnace temperature can minimise this. Dust is abated in a fabric filter and the zinc oxide content is usually recovered.

Use of indirect cooling systems or a water-cooling closed circuit and reuse of the rolling processes' emulsion

Most casting operations (with the exception, for example, of the Upcast process) use direct cooling water for the final solidification and cooling of the cast strand down to temperatures suitable for further handling. The cooling water can be recirculated after separation of the solids.

With wire rod production or other process integration, like continuous casting and rolling processes, emulsion (oil-water lubricant mixture) is delivered to the roll stands of the rolling mills and combined with the casting rolling processes, in order to cool and protect the rolls, and to keep air from oxidising the copper surface. The emulsion is collected beneath the rolls, pumped through a filter to remove solid particles (copper scale) and collected in a tank, from where it is then pumped back to the rolling stands. Copper scales are recycled to a smelter for copper recovery. Depending on the type of emulsion, the spent emulsion can be reprocessed.

Achieved environmental benefits

- Prevention and reduction of dust, TVOC and PCDD/F emissions.
- Recovery of copper and raw material savings.
- Recovery of the energy content of the shaft furnace's flue-gases.

Environmental performance and operational data

In Aurubis Hamburg, wire rod is produced on a SCR line. The Southwire process is a continuous casting and hot rolling process. The copper is melted continuously in a shaft furnace (melting rate 60 t/h). The furnace off-gases are captured and dedusted in two bag filters (flow rate 100 000 Nm³/h). Dust levels are in the range of < 0.5–10 mg/Nm³ (half-hourly average) and < 0.5–5 mg/Nm³ (daily average). The molten copper is transferred via a gas-heated launder to a 24-tonne holding furnace and then via launder to the casting tundish and the casting wheel. The casting wheel is a rotating copper alloy ring, which is covered partially by a moving steel strip. The liquid copper is cooled using indirect and direct water cooling.

An installation for the continuous casting of billets and cakes is also in operation. The installation includes two shaft melting furnaces, three holding induction furnaces, and three multi-strand continuous casters for billet and cake casting. Both shaft furnaces are normally in continuous operation, with a maximum total melt rate of 70 t/h. The casting rate is 5–35 t/h, depending on the shape, copper quality and number of strands.

Cathode, copper scrap and chips are charged by elevator bins to the shaft furnaces. The molten copper is transferred by launder from the shaft furnace to the holding furnace. Alloying elements such as silver or phosphorus (as copper alloy) are dosed to the launders and/or holding

furnaces and evenly distributed in the molten copper within the holding furnace. Shaft furnace off-gases are captured and, depending on the temperature, quenched with water and dedusted in bag filters (flow rate 40 000 Nm³/h each). Dust levels are in the range of < 0.5–6 mg/Nm³ (half-hourly average). From the holding furnace, the copper is dosed into the casting moulds of the vertical continuous casters. The solidified copper, leaving the casting mould, forms a continuous cake or billet strand, which is cut to the required length by a flying saw as the cast strands come down. The cast strand is cooled with water. The water is partly recirculated; the bleed is discharged after settling and the separation of solids.

At Aurubis Olen, a Contirod plant is in operation, processing copper cathodes and high-purity copper scrap to produce wire rod. A shaft furnace is used to melt copper. Molten copper from the furnace flows via a launder equipped with siphons into a tiltable, gas-heated holding furnace. The copper then flows to the pouring funnel, which automatically controls the feeding rates to the caster. A twin belt casting machine is used. The two belts are cooled by a continuous film of water that moves at high speed along the length of their surface.

The shaft furnace is loaded through a closed loading system that prevents heat/gases escaping from the installation. The feed of the furnace is preheated by the exhaust gases in the furnace shaft. Exhaust gases preheat the combustion air for the burners through a heat exchanger. The rolling stands and pickling line are covered.

The off-gases are rapidly cooled/quenched and dedusted in a bag filter (flow rate 30 000 Nm³/h). Before the bag filter, a lime and active coal system are used to abate the dioxin emissions. The preselection of scrap to minimise the quantity of potential precursors or organic material is also practised. Measured levels are in the range 0.026–0.25 ng I-TEQ/Nm³. Dust levels are in the range of 1–7 mg/Nm³. The dust collected in the bag filter is sent for recycling or disposed of. Water arising (after wire rod pickling) is pretreated (e.g. neutralisation with NaOH), then collected in a common sewage system (together with cooling water, process water and rainwater) and treated in a physical/chemical water treatment plant.

In the Upcast installations, copper cathodes are melted and cast into oxygen-free wire rod. One characteristic of this installation is that, throughout the process, there is no contact with the ambient air, so copper is not able to oxidise. The installations consist of a melting furnace and a casting furnace or a combination of both. After being melted in the casting furnace, the copper solidifies on a starter piece and is pulled upwards through water-cooled tubes. The oxygen-free wire rod is then coiled in a set of coilers. These operations do not cause emissions to the environment.

At Aurubis Avellino, copper wire rod is produced by the Contirod process. The copper is melted continuously in a shaft furnace. Hoods are installed at the shaft furnace launder, holding furnace and casting launder. Exhaust gases (flow rate 60 000 Nm³/h) are cleaned in two parallel bag filters, after passing through two cyclones in series and a heat recovery system. Dust emissions are below 1 mg/m³. The feed of the furnace is preheated by the exhaust gases in the furnace shaft. Exhaust gases preheat the combustion air for the burners through a heat exchanger. The liquid copper is cooled using indirect and direct water cooling. Cooling water and process water are treated in a physical/chemical water treatment plant.

At Aurubis Pori, billets and cakes are produced continuously in different copper specifications, depending on the final application. The installation includes a shaft melting furnace and a casting induction furnace, and a continuous caster for billet and cake casting. The maximum melting rate is 22 t/h. The casting rate is 6–20 t/h, depending on the shape and copper quality. Internal and external scrap (minimum 99.9 % Cu), e.g. bales, chips, sawn and cut scraps, and small amounts of cathodes are charged by the elevator bins to the shaft furnace. The shaft furnace is heated with butane gas burners. The molten copper is transferred by launder from the shaft to the casting furnace. Alloying elements and/or phosphorus (as copper alloy) are dosed to the launders. Shaft furnace off-gases are captured and heated up to 750 °C in an afterburner section and dedusted in a bag filter (maximum flow rate 30 000 Nm³/h). Dust levels are in the range of < 0.2–4 mg/Nm³ during normal operation. The heat in the exhaust gas is recovered in a

hot oil system, and sold to steam production. The heat in the launder gases is recovered as heating water in the copper foundry.

From the casting furnace, the copper is dosed into the casting mould of the vertical caster. The solidified copper, leaving the casting mould, forms a continuous cake or billet strand, which is cut to the required length by a flying saw as the cast strands come down. The cast strand is cooled with internal circulation water, which is cooled in a cooling tower.

Wieland-Werke produces billets and slabs and operates a special foundry for copper alloys. The foundry contains induction crucible furnaces. Metals and scrap are melted in the foundry and alloys are cast as billets or slabs. Semi-continuous vertical casting is performed for slabs. The finished slab is cut at both ends with a saw. Continuous vertical casting is performed for billets. A flying saw cuts the billets to the required length. Emissions are extracted by fans and cleaned in cyclones followed by a bag filter. The dust concentration in the flue-gases is measured continuously and emissions below 2 mg/m^3 (yearly average) are reported.

KGHM Cedynia produces wire rod with the Contirod and Upcast processes. In the Contirod process, cathodes with a small addition (below 1 %) of high-purity scrap are melted in a furnace, which processes 45 tonnes of copper per hour. The furnace is fuelled with natural gas. The installation of a cleaning system for off-gases with a bag filter is planned. The melted copper is transported via a launder from the furnace into a gas-heated holding furnace. The liquid copper is then transported to the casting machine. Copper is cast and processed in 16-stand rolling blocks. During the casting and rolling operation the copper is cooled by emulsion sprinkling. The emulsion circulates in a closed circuit. The withdrawn emulsion is vacuum distilled. The casting belts of the casting machine are cooled by water sprinkling. The cooling water circulates in a closed circuit, which is temporarily refreshed. The bleed is discharged into the waste water treatment plant.

In the Upcast process, copper cathodes are melted and cast into oxygen-free wire rod. The installation consists of a cathode charging system, a melting furnace, a settling furnace, a casting machine with crystallisers for vertical casting and coiling machines. The specificity of this installation is that there is no contact with the ambient air throughout the process, so the copper is not able to oxidise and there are no emissions to the atmosphere.

One of the final products of the KGHM Legnica smelter are round billets with a diameter of 150–310 mm. Copper cathodes and high-purity copper scrap - starting sheets from electrorefinery - are melted in an induction furnace. Liquid copper is fed into the induction casting furnace. The casting section is equipped with stopper devices and feeds copper to the crystallisation section. Solid copper is transported by a pulling roll into a vertical position. The charging section is equipped with a local ventilation system, from which the sucked gases are discharged to atmosphere through a stack. The dust levels are in the range of $1\text{--}8 \text{ mg/Nm}^3$ (3 mg/Nm^3 , as an average of one year's measurements).

In Buntmetall Amstetten, the off-gases from the induction crucible, channel melting and casting furnaces are divided into two streams and are treated in a cyclone followed by a bag filter. The dust levels are in the range of $0.5\text{--}2 \text{ mg/Nm}^3$ and the sum of metals such as Zn, Cr, Cu, Sn are in the range of $0.1\text{--}0.6 \text{ mg/Nm}^3$ (discontinuous measurement once every three years).

Cross media effects

- Increase in energy use.
- Use of additives.
- Waste can be produced if the collected dust cannot be reused.

Technical considerations relevant to applicability

The fume collection and abatement systems used depend on the raw material and degree of contamination present (quality of scrap, volatility of alloying elements), as well as on the furnace type.

Capture hoods or enclosures for flue-gas collection are mainly applied when processing copper alloys.

Afterburners are used where there is a high level of organic contamination; alternatively, the furnace combustion control system should be able to accommodate the combustion of contaminants.

Bag filters are generally applicable.

If fire refining is carried out to adjust the alloy composition, the resulting flue-gases have to be taken into account in the design of the fume collection and abatement systems.

More stringent operating conditions and abatement systems can be appropriate when hazardous materials, such as beryllium, are used or when reactive materials, such as phosphorus, are added to produce an alloy.

Economics

Based on a typical shaft furnace size of 40–50 t/h with an approximate off-gas flow rate of 50 000–80 000 Nm³/h, the investment costs for a bag filter with piping, water quenching and handling of absorption agents are in the magnitude of EUR 2 million.

Operational costs based on a five-day week operation for the aforementioned off-gas cleaning installation are in the magnitude of EUR 0.5 million per year. In this estimation, the blower energy and maintenance of the system, followed by additive purchase, additive disposal, and air for the quenching system are the key cost factors.

The investment costs and operational costs are influenced strongly by the layout of the system and the unit costs for energy and consumables, which can vary considerably.

Driving force for implementation

- Environmental legislation requirements.
- Recovery of raw materials and reduction in energy use.

Example plants

Aurubis Hamburg (DE), Aurubis Olen (BE), Aurubis Avellino (IT), Aurubis Pori (FI), Wieland-Werke (DE), KGHM Cedynia and Legnica (PL).

Reference literature

[238, ECI 2012], [383, Copper subgroup 2012]

3.3.5.2 Technique to prevent and reduce emissions from non-acid and acid pickling of copper rods and semis of copper and copper alloys

Description

Techniques to consider are:

- encapsulated pickling line with a solution of isopropanol operating in a closed circuit;
- encapsulated acid pickling line with an air extraction system connected to an abatement system;
- flue-gas cleaning with a wet scrubber or catalytic afterburner;
- recycling the pickling solutions and the rinse water;
- treatment of spent acid/rinse water for recovery of metals.

Technical description

Pickling is applied to remove oxide layers and other impurities from the surface of copper wire rods and semi-finished products (see Figure 3.16). Heat-treated semis require a surface treatment consisting of a combination of pickling and rinsing before further processing. Solutions of isopropanol (IPA), sulphuric acid, hydrochloric acid, hydrogen peroxide, and sometimes a mixture of diluted sulphuric and nitric acids can be used for pickling in continuous lines (continuous loop products) or immersion systems (material in lumps).

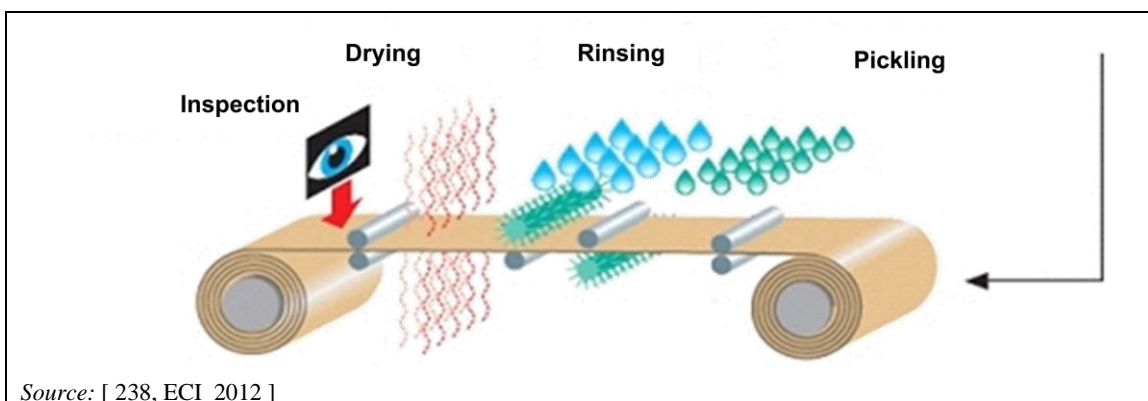

Figure 3.16: Continuous pickling process

The non-acid pickling of wire rod is performed with a solution of isopropanol in water. The rod is further dried using compressed air and given a coating of wax to prevent oxidation of the surface of the rod.

The following measures can be applied to prevent and reduce emissions:

- encapsulation of continuous pickling lines;
- in immersion pickling lines, extraction is only necessary in the event of aerosol formation;
- operation of the non-acid pickling process in a closed circuit;
- removal of sludge/solids from pickling solutions by filtration or by settling and cleaning of the system;
- use of sludges for metal recovery.

The acid pickling of copper wire rod is performed with diluted sulphuric acid. Then the residual acid is washed in several stages from the rod surface by water sprays, followed by drying using compressed air and coating with wax.

The typical surface treatment of copper/copper alloyed flat rolled products (semis) usually includes a combination of the following steps.

- Degreasing (e.g. by aqueous surfactant).
- Rinsing (first rinse with hot water at 60 °C, final rinse with cold demineralised water).
- Pickling with a solution of sulphuric acid (4–15 %). For heavily scaled materials (for example some alloys), mixtures of sulphuric acid with diluted nitric acid or oxidising hydrogen peroxide can be used.
- Rinsing.
- Polishing/brushing for mechanical removal of impurities by adding demineralised water.
- Rinsing to remove brush residues.
- Drying with blast hot air.

The following measures can be applied to prevent and reduce emissions in semis pickling lines.

- Pickling lines are encapsulated and equipped with extraction systems to reduce diffuse emissions.
- Air washers with mist collectors or scrubbers are used to treat the vapours formed by acid pickling baths. Acid vapour is condensed and recycled back to the pickling bath. Aerosols are avoided or recycled and returned to the pickling bath.
- For pickling with nitric acid, washers or catalysers are used to reduce NO_x fumes and recover nitric acid.
- Measures are applied to extend the lifespan of the pickling solution, such as cleaning pickling solutions during the process with oil separators and by filtration and reusing the acid. Spent pickling acid can be treated by electrowinning to recover dissolved metals.
- Multiple cascade rinsing to reduce water consumption.
- Rinse water from the second stage can be used to compensate evaporation losses from the hot rinse at the first rinsing stage. This avoids waste water arising that would otherwise need to be purified.
- Rinse water can be treated by neutralisation with lime or sodium hydroxide. Sludges/residues are recycled where possible.
- Recycling of demineralised rinsing water during the brushing stage. Also, purification of demineralised water in an ion exchanger.
- For surface degreasing of rolled products, detergents may be used. The spent water is cleaned by filtration. If organic solvents are used for surface degreasing, a vapour degreasing system is used.
- Remaining liquids that cannot be reused are treated in a waste water treatment plant (physical and chemical treatment).

Hot water is more effective for cleaning than cold water. This results, however, in increased energy consumption. Cascade rinses require a higher pumping capacity and thus an increased power supply. However, the waste water to be purified decreases with the use of cascade rinsing. The cleaning effort is reduced due to the smaller amount of waste water and so the pumping capacity in the ion exchanger also decreases.

Achieved environmental benefits

- Minimisation of VOC and acid mist emissions.
- Minimisation of waste water, by recycling pickling solutions or rinse water.
- Reduction of water consumption, by using multiple cascade rinsing.
- Recovery of metals, hence promoting raw material savings and minimisation of waste streams.
- Energy recovery from hot waste water, for the preheating of fresh water.

Environmental performance and operational data

A large number of pickling lines can be applied. Important elements are summarised in Table 3.58.

Table 3.58: Techniques to reduce emissions from acid and acid pickling of copper rods and semis of copper and copper alloys

Process	Degreasing	Rinsing	Pickling	Rinsing	Brushing	Drying
Continuous pickling line	Spray cleaning, brush cleaning, ultrasonic cleaning or other techniques at 60 °C with a pickling bath volume of approx. 3 m ³	Cascade rinse with replenishment of demineralised water	Continuous pickling line with a pickling bath volume of approx. 5 m ³ - Sulphuric acid - Mixed acid consisting of sulphuric acid and nitric acid - IPA for wire rod	Cascade rinsing and drainage to waste water treatment	Brushing machine with demineralised water. Water throughput and drainage to ion exchanger	Hot rinse with demineralised water and subsequent air blowoff
Immersion pickling equipment	Not applicable	Not applicable	Pickling basket 8 m ³	Cascade rinsing and drainage to waste water treatment	Not applicable	Hot rinsing sink
<i>Source:</i> [383, Copper subgroup 2012]						

At Wieland-Werke, wet scrubbers with mist collectors are used for the suctioned vapours formed by the pickling bath. The acid vapour is condensed and recycled for return to the pickling bath. Aerosols are avoided. Emission values of between 0.3 mg/Nm³ and 10 mg/Nm³ as half-hourly average are achieved. The emissions from the pickling bath that contain nitric acid are treated in a wet scrubber or in a catalyser's afterburner to reduce NO_x. Emission values of between 250 mg/Nm³ and 350 mg/Nm³ as half-hourly averages are achieved. The pickling baths are cleaned during the process, e.g. by oil separators, filtration, acid recycling or acid treatment of the acid baths.

Evaporation losses of the hot rinse in the first cascade are compensated by water from the second stage. This avoids waste water arising that would otherwise needed to be purified. The recycling of demineralised rinsing water during brushing is performed, and purification of the rising water is carried out by an ion exchanger.

At Aurubis Hamburg, to cool and to deoxidise (pickle) the hot rolled rod, there are several cooling sections between the rolling mill and the coiler station. The cooling agent contains isopropanol in order to deoxidise the copper oxides on the surface by chemical reduction. The IPA solution circulates in a closed loop. The line is encapsulated. Solid copper or oxide particles are collected and recirculated into the copper refinery.

At Aurubis Olen, pickling of the wire rod is performed with a solution of sulphuric acid. The pickling section is encapsulated. A wet scrubber is used for the exhaust from the pickling line. Spent acid is treated in electrowinning cells to recover metals. Rinsing water is pretreated (e.g. neutralisation with NaOH), then collected in a common sewage system (together with cooling

water, process water and rainwater) and treated in a physical/chemical waste water treatment plant.

At Aurubis Avellino, to cool and deoxidise the hot rolled rod, a water, IPA and alkaliser mixture is used. The line is encapsulated. The IPA solution circulates in a closed loop.

At Schwermetall Halbzeugwerk GmbH & Co KG, degreasing of strip is carried out by the use of a combination of spray, brush and electrolytic cleaning. Pickling of the copper strip is done by the use of sulphuric acid followed by abrasive brushes. Cleaning of these baths occurs during the process, e.g. by filtration.

In KGHM Cedyňa, a 4–5 % solution of isopropyl alcohol and demineralised water is used for pickling copper rods. The pickling solution is kept in a closed circuit, with no release to the environment. The IPA consumption is 1.5 dm³ per tonne of copper wire rod. Under pressure, bag filters are used to separate copper oxides from the rolling emulsion and pickling solution. The oxides are transferred to a copper smelter for copper recovery.

The withdrawn rolling emulsion and pickling solution are vacuum distilled. The water is recirculated for emulsion preparation or for supplying the cooling circuit, and no waste water is discharged.

Cross-media effects

- Increase in energy use.
- Recovery of IPA from fumes increases the energy consumption due to the operation of the scrubber and distillation column. The boiler is used to preheat the inlet water to the distillation column up to 95 °C, which requires additional energy consumption. The vacuum increases the vaporisation of IPA and efforts to condition the solution and separate the IPA can be considerable and inefficient.

Technical considerations relevant to applicability

Techniques are applicable to new and existing plants depending on the requirements for appearance before further processing and the presence of specific reactive alloying constituents. Limitations related to the area available and space requirements need to be considered.

Economics

The costs depend largely on the shape of the product to be cleaned, on the agents used, and on the requirements for the surface.

Driving force for implementation

- Environmental regulation requirements.
- Waste water reduction.
- Recovery of raw materials.

Example plants

Aurubis Hamburg (DE), Aurubis Olen (BE), Aurubis Avellino (IT), Wieland-Werke (DE), Schwermetall Halbzeugwerk (DE), and KGHM Cedyňa (PL).

Reference literature

[238, ECI 2012], [383, Copper subgroup 2012]

3.3.5.3 Techniques to prevent and reduce air emissions from lead and tin recovery from secondary copper intermediates

Lead and tin are recovered from specific secondary copper intermediates as by-products from secondary copper refining processes. Multistage reduction processes are applied to produce lead-tin alloy (in a TBRC or a rotary furnace or shaking ladle) and to further refine the alloy. There is no production of primary tin in the EU-28.

The production of lead-tin alloy from copper intermediates is only applicable for new installations or after significant plant upgrade, and it depends on the secondary input material used in the process.

Description

The techniques to consider are:

- enclosed furnaces;
- capture hoods with a flue-gas extraction system;
- bag filter.

Technical description

Prevention and collection techniques are described in Section 2.12.4.3.

Bag filters are described in Section 2.12.5.1.4.

Achieved environmental benefits

- Reduction of dust emissions.
- Recovery of lead and tin.

Environmental performance and operational data

At Metallo-Chimique (secondary copper smelter), a second reduction stage is used after the first reduction stage to recover mainly copper from slag [90, Traulsen, H. 1998]. In this second stage, other tin- and lead-containing slag, residues and scrap can be added to the furnace. Lead and tin (in oxide form) are reduced from the slag with steel scrap or tin cans in a TBRC. A crude lead-tin alloy is produced in this way. The alloy is treated in a shaking ladle with silicon to remove the majority of the copper, nickel and iron. Any remaining copper, nickel, iron or zinc is subsequently removed by adding sulphur and sodium hydroxide at a lower temperature to the melt. The decoppered lead-tin alloy is then treated in a dedicated lead-tin refining plant. The operational data are summarised in Table 3.59.

Table 3.59: Operational and performance data for lead and tin recovery from secondary copper intermediates

Parameter	TBRC (big)	TBRC (small)	Shaking ladle
Working capacity	120–160 t/charge	20 t/charge	30 t/charge
Primary off-gas (cooler, cyclone, bag filter)	70 000 m ³ /h	35 000 m ³ /h (including secondary off-gas)	Max. 46 000 m ³ /h
Dust	0.5–2 mg/Nm ³	0.5–2 mg/Nm ³	0.5–2 mg/Nm ³
Secondary off-gas (bag filter)	70 000 m ³ /h	Not applicable	Not applicable
Dust	0.5–2 mg/Nm ³	Not applicable	Not applicable

At Aurubis Lünen, a special rotary lead alloy furnace is used [234, UBA (D) 2007] with a multistage reduction process to produce black copper, tin-lead alloy and iron silicate slag from

the KRS or TBRC slag. As well as the molten converter slag, other intermediates from on-site production or from third parties and secondary materials can be used as input materials. Materials or additives can be charged throughout the process. The slag composition is controlled within defined limits to obtain a marketable product. After a final granulation step, the slag can also be sold. The black copper is recirculated into the KRS or TBRC furnace. The process and secondary hood off-gases are routed to filter systems. The collected flue-dust is either marketed or returned to the KRS bath furnace. The refining of the tin-lead alloy includes the following steps:

- segregation and dedrossing (removal of copper and nickel);
- removal of the remaining copper, zinc and arsenic by adding sulphur, ammonium chloride and aluminium.

Table 3.60: Operational and performance data for a rotary lead alloy furnace

Parameter	Rotary furnace	Refinery
Working capacity	60–80 t/charge	30 t/charge
Off-gas (process and secondary hood)	100 000 m ³ /h	60 000 m ³ /h

Furnace process off-gas and secondary hood gas are treated together with the KRS gases (see Section 3.3.4.1).

Cross-media effects

Increase in energy use.

Technical considerations relevant to applicability

Generally applicable.

Economics

No information provided.

Driving force for implementation

Environmental regulation requirements.

Example plants

Aurubis Lünen (DE) and Metallo-Chimique Beerse (BE).

Reference literature

[90, Traulsen, H. 1998], [234, UBA (D) 2007], [238, ECI 2012], [383, Copper subgroup 2012]

3.3.6 Waste water

3.3.6.1 Waste water prevention

Description

The techniques to consider are:

- making multiple uses of the same water flows (cascading cooling water, reusing cooling water or condensed steam for process purposes and reusing process water (in this case, contact cooling water is considered process water) for another application, if feasible);
- avoiding wet process gas treatment techniques, if feasible;
- installing closed loop cooling with air coolers as secondary heat exchangers;

- minimising the drainage of evaporation coolers;
- maximising the recirculation for reuse of water flows after treatment;
- separating uncontaminated water flows (rainwater, non-contact cooling water) from process water flows.

Technical description

A description of general process-integrated measures for water recycling and reuse can be found in Section 2.12.6.1.

Achieved environmental benefits

- Reduction of the amount of water to be treated, and hence less pumping energy, and less reagents used.
- Reduction of the amount of pollutants to be discharged into the receiving water body.
- Reduction of heat transfer to the receiving water body (for the installation of closed loop cooling with air coolers as secondary heat exchangers).

Environmental performances and operational data

At Umicore Hoboken, the steam condensate in the electrowinning is reused for washing the copper cathodes. The water that is injected to cool the smelter gases is condensed together with the water from the raw materials and is reused for quenching this gas flow. Rainwater, excess sprinkling water, cooling water, drainage water, etc. are collected in a separate sewer system and are treated in order to be reused as sprinkling water and cooling water, thus providing 60 % of the total amount of water needed in the plant. Drainage of evaporation cooling towers is minimised. Water from washing the filter content in the leaching plant is reused in the leaching process.

At KGHM (Głogów 1, Głogów 2 and Legnica smelters), the steam condensate (formed while heating electrolyte in the electrorefining process) is reused for washing the copper cathodes. The cooling and technological circuits are closed as much as possible. The bleed is discharged to the smelters' waste water sewers and finally to the local waste water treatment plants. Acidic waste water is first neutralised, rainwater is stored, and domestic waste water is biologically pretreated in an Imhoff tank. Then all the pretreated streams and bleed from the cooling circuits are mixed, coagulated and discharged into the river. However, some of the cleaned waste water is utilised.

In Legnica, there is a buffer reservoir, from which purified waste water is utilised for sprinkling waste storage yards, and some may be returned to supply the technological circuits.

In Głogów 1 and Głogów 2, a third of the cleaned waste water is utilised for sprinkling the storage yards, for supplying the cast anode cooling circuit and as make-up water for some other water circuits.

At the Montanwerke Brixlegg site, due to a limited use of groundwater, most of the cooling water is used in several cascades. For example, the warmed-up cooling water of the anode furnace is used for vaporisation of the oxygen and then sent back to the furnace, while the surplus is then sent to another point of use.

At Aurubis Hamburg, surface (rain) water is collected, cleaned by chemical treatment and then used for cooling purposes and for slag granulation. At Aurubis Avellino, rainwater is collected in tanks, undergoes physical treatment and is then reused as cooling water.

At Atlantic Copper, the purified water of waste water treatment plant (WWTP) is partially reused as make-up water in gas-cleaning processes instead of fresh water.

Cross-media effects

No information provided.

Technical considerations to applicability

Techniques to make multiple uses of the same water flows or for the recirculation or reuse of water flows after treatment can only be applied if the required criteria for the following process are met in terms of flow rate, temperature, composition and acidity.

Avoiding wet process gas treatment is not always possible, e.g. when the gases to be treated contain a lot of water, acid mist or sticky substances.

Installing closed loop cooling with air coolers as secondary heat exchangers requires much more space to install the air coolers, as they are much less efficient than evaporation coolers.

Condensed steam should preferably be reused for steam generation. But when the distance to the steam generator is too high, its use for process purposes is recommended instead.

Economics

In some existing plants, the implementation of these techniques might involve high investment costs.

The techniques to make multiple uses of the same water flow require additional investment in intermediate storage capacity, in order to balance the in- and outputs of the dependent processes.

An economic consideration has to be made for the separation of uncontaminated water flows from process waters. The investment in separate sewer systems has to be balanced with the amount of uncontaminated rainwater that can potentially be recovered.

Driving force for implementation

- Minimisation of waste water generated and hence reduction of cost of waste water treatment.
- Reduction of the amount of pollutants discharged into the receiving water body.

Example plants

Umicore Hoboken (BE), KGHM Głogów 1, Głogów 2 and Legnica (PL), Aurubis Hamburg (DE), Aurubis Avellino (IT), and Atlantic Copper Huelva (ES).

Reference literature

[238, ECI 2012], [383, Copper subgroup 2012]

3.3.6.2 Waste water treatment and reuse in primary and secondary copper production

Description

The techniques to consider to treat effluent water (with the exception of cooling water) prior to discharge are:

- chemical precipitation;
- sedimentation or flotation;
- filtration.

Technical description

The main sources of liquid effluents are described in Section 3.2.2.4.

Chemical precipitation, sedimentation, flotation, filtration and process control techniques for effluent treatment are techniques widely applied in the non-ferrous metals industry, and are already described in Sections 2.12.6.2 and 2.12.3.3.

Achieved environmental benefits

- Removal of suspended and coarse particles, metals, acids, sulphates and fluorides from waste water, rendering it suitable for discharge or reuse.
- Production of a sludge for reuse (e.g. pure gypsum for sale, sludge with valuable metals that can be reused in the production process), thus avoiding the production of waste to be disposed of.
- Production of a sludge with a high concentration of harmful metals (cadmium, arsenic), which reduces the amount of waste to be disposed of.
- Production of water suitable for reuse within the plant, e.g. for sprinkling, cooling, industrial cleaning and for some processes.

Environmental performance and operational data

The reduction of emissions of metals, suspended solids and other compounds depends on the site-specific conditions. The composition of the liquid effluents from pyrometallurgical and hydrometallurgical operations very much depends on the production process and the raw material used. However, normally liquid effluents from copper production plants contain metals, e.g. copper, lead, zinc, tin, nickel, cadmium, chromium, arsenic, molybdenum, mercury and suspended solids.

The resulting concentrations of metals after treatment highly depend on the composition of the incoming waste water flows, which in turn depends on the composition of the raw materials treated and the production processes applied. The more complex an incoming waste water, the more interactions there will be, and it will likely be more difficult to remove the pollutants. Sometimes not all metals can be removed with the same efficiency as the optimum conditions for the removal of one metal can be influenced by the presence of other metals.

To evaluate the efficiency of the cleaning process, waste water treatment and targeted sampling must be considered. Combined waste water streams (surface run-off water, process water, indirect and direct process water), which are collected and treated in a central waste water treatment plant, are usually more diluted than separated waste waters, which are treated in specialised waste water treatment plants. Concentrated process water and less polluted rainwater require different types of treatment. For process water more metal removal stages are usually applied while for rainwater there is a big variation in inlet pollutant concentration depending on the changing weather conditions.

The following table summarises the clean-up rates for different waste water streams.

Table 3.61: Performance of a waste water treatment plant

Source	Main component (mg/l)					
	Cu	Pb	As	Ni	Cd	Zn
Concentrated process water Before treatment	≤ 2900	≤ 4500**	≤ 10 000	≤ 4000	≤ 3100	≤ 5000
After treatment	< 0.26	< 0.3	< 2	< 1	< 0.1	< 2.15
Surface run-off water Before treatment	≤ 30	≤ 5	≤ 2	≤ 2	≤ 0.5	≤ 10
After treatment	< 0.5	< 0.5	< 0.09	< 0.5	< 0.11	< 1
Combined waters* Before treatment	≤ 37	≤ 33	≤ 24	≤ 27	≤ 75	≤ 8
After treatment	< 0.7	< 0.25	< 0.17	< 0.5	< 0.021	< 1
<p>* Treatment of process water with surface water and/or cooling water together in one plant (i.e. typically high dilution).</p> <p>** Non-ferrous metallurgy effluents usually contain sulphate ions, which form insoluble lead sulphate(VI). The solubility of Pb from the compound is around 4 mg/l only.</p> <p>Source: [378, Industrial NGOs 2012]</p>						

The process water treatment at Aurubis Pirdop collects weak acid from the acid plant, bleed from the electrolytic refining, and wet scrubber water from the smelter secondary gas cleaning and some surface water, processing the combined stream in a central multistage chemical water treatment plant consisting of three stages:

- clean gypsum precipitation (treatment with lime milk, pH 1–1.3, flocculant, precipitation of clean gypsum);
- metal precipitation (treatment with lime milk, FeCl₃, H₂O₂, flocculant and increase of pH to 9–10; capture of metals by precipitation);
- arsenic removal (treatment with lime milk, FeCl₃ and H₂O₂ to capture the remaining arsenic, pH 6–8).

The inlet water composition varies depending on the concentrate quality, the off-gas properties and the operation of the wet gas cleaning systems.

Table 3.62: Composition of process waters before and after treatment at Aurubis Pirdop

Parameter	Unit	Inlet values	Emission levels range *	
			90 th percentile	Maximum
Flow	m ³ /h	100	Not applicable	Not applicable
Flow	m ³ /yr	950 000	Not applicable	Not applicable
H ₂ SO ₄	g/l	60	Not reported	Not reported
Cu	mg/l	2100	0.05	0.26
As	mg/l	2200	0.07	0.1
Pb	mg/l	30	0.016	0.3
Ni	mg/l	450	0.15	1
Zn	mg/l	500	0.07	1
Cd	mg/l	200	0.015	0.1
Suspended solids	mg/l	200	Not reported	50

* Range is between 90th and 100th percentile values of measured data.
 NB: A composite sample is collected from the water discharge every 6 hours (4 composite samples per day). Sampling is time-proportional and is performed by an automatic sampler.
 Source: [378, Industrial NGOs 2012]

The amount of sludge produced is 6–7 t/h (40–50 % moisture), with the following composition: ~ 30–35 % CaSO₄, ~ 1 % As, ~ 1 % Cu, 1–2 % Fe, ~ 1 % Pb, ~ 0.1 % Ni, and ~ 0.1 % Cd.

The process water treatment in Aurubis Hamburg treats weak acid from the off-gas cleaning of primary and secondary copper smelters, and additional effluents from the precious metals plant, chemical plant, laboratory waste water, condensates, and from other small site sources. The flows are directly connected with the two-stage treatment plant, which incorporate:

- arsenic removal, by reaction with iron(III) and neutralisation followed by metal precipitation;
- a polishing step, consisting of a sulphide precipitation in the presence of iron(II).

Changing gas properties depend on the concentrate quality and result in a changing waste water composition. Additionally, the batch-wise feed of additional sources increases the variety of waste water. Often the process needs to be adapted for optimised performance. Process adaptation is based on daily samples and manual adjustments for process settings.

Table 3.63: Composition of process waters before and after treatment at Aurubis Hamburg

Parameter	Unit	Inlet values	Emission levels *
Flow	m ³ /yr	180 000	Not applicable
H ₂ SO ₄	g/l	50	Not reported
Cu	mg/l	2000	0.0–0.2
As	mg/l	2000	0.06–0.09
Pb	mg/l	500	0.03–0.05
Ni	mg/l	1000	0.05–0.06
Zn	mg/l	1000	0.17–0.2
Cd	mg/l	500	0.01–0.02
Hg	mg/l	Not reported	0.019–0.024
Suspended solids	mg/l	Not reported	15
* Range is between the 90th and 100th percentile values of measured data. NB: Discharge water is monitored based on spot samples: weekly for Cu, As, Cd and Hg and monthly for Pb, Ni and Zn. Source: [378, Industrial NGOs 2012]			

The treatment of surface run-off water from the east plant area and the blowdown of direct cooling water at the anode casting facility at Aurubis Hamburg is done by a different plant. In this case, treatment is performed by coagulation, and metal precipitation by pH setting followed by flocculation and sedimentation.

Changing inlet waste water conditions are caused by changing weather conditions, combined with a discontinuous flow of direct cooling water from the anode casting. Often process adaptation is required for optimised performance. Process adaptation is based on daily samples and manual adjustments for process settings.

Table 3.64: Composition of the surface run-off water from the east plant area and blowdown of direct cooling water at the anode casting facility before and after treatment at Aurubis Hamburg

Parameter	Unit	Inlet conditions, range	Emission levels *
Flow	m ³ /yr	700 000	Not applicable
Cu	mg/l	15–30	0.35–0.5
As	mg/l	< 2	0.05–0.09
Pb	mg/l	< 5	0.06–0.25
Ni	mg/l	< 2	0.124–0.5
Zn	mg/l	1–10	0.3–1
Cd	mg/l	< 0.5	0.016–0.021
Hg	mg/l	Not reported	0.0032–0.021
Suspended solids	mg/l	Not reported	20
* Range is between the 90 th and 100 th percentile values of measured data. NB: Discharge water is monitored based on spot samples: weekly for Cu, As, Pb, Ni, Cd and monthly for Zn and Hg. Source: [378, Industrial NGOs 2012]			

The treatment of surface run-off water from the area covering the secondary copper smelter, the shapes installations, and lead refinery at Aurubis Hamburg is done by a separate plant. In this

case, treatment is performed by coagulation, and metal precipitation by pH setting followed by flocculation and sedimentation.

Table 3.65: Composition of the surface run-off water from the area covering the secondary cooper smelter, shapes installations and the lead refinery before and after treatment at Aurubis Hamburg

Parameter	Unit	Inlet conditions, range	Emission levels *
Flow	m ³ /yr	500 000	Not applicable
Cu	mg/l	15–30	0.18–0.5
As	mg/l	< 2	0.03–0.09
Pb	mg/l	< 5	0.14–0.5
Ni	mg/l	< 2	0.14–0.5
Zn	mg/l	1–10	0.25–1
Cd	mg/l	< 0.5	0.05–0.11
Hg	mg/l	Not reported	0.0065–0.014
Suspended solids	mg/l	Not reported	50
* Range is between the 90 th and 100 th percentile values of measured data. NB: Discharge water is monitored based on spot samples – weekly for Cu, As, Pb, Ni, Cd and monthly for Zn and Hg. Source: [378, Industrial NGOs 2012]			

At Aurubis Olen, water flows of rainwater, cooling water, domestic water and process water are collected in a common sewerage system and treated in a physical/chemical waste water treatment plant. Effluents include cooling water from anode casting and the wire rod plant.

Rinsing water (after wire rod pickling) is pretreated (e.g. neutralisation with NaOH), collected in a common sewerage system (together with cooling water, process water and rainwater) and then treated in a physical/chemical waste water treatment plant. Treatment involves the following steps: grid and sand trap, buffering, acidification, alkalisation, flocculation, sedimentation, neutralisation of clear water, and centrifugation of sludge.

Changing inlet waste water conditions are caused by changing weather conditions, combined with a discontinuous flow of direct cooling water and other process water. No data are available for the inlet concentrations.

Table 3.66: Composition of waste water after treatment at Aurubis Olen

Parameter	Unit	Emission levels *
Flow	m ³ /yr	519 000
Cu	mg/l	0.2–0.7
As	mg/l	0.03–0.1
Pb	mg/l	0.01–0.05
Ni	mg/l	0.08–0.15
Zn	mg/l	0.08–0.16
Cd	mg/l	0.001–0.006
Suspended solids	mg/l	0.2
* Range is between the 90 th and 100 th percentile values of measured data. NB: Composite 24-hour samples are collected from the waste water discharge. Sampling is flow-proportional and is performed by an automatic sampler. One sample per month is analysed. Source: [378, Industrial NGOs 2012]		

The waste water treatment plant at Montanwerke Brixlegg has the task of cleaning any process water effluent that occurs in the production lines of the nickel sulphate plant, precious metals plant and the oxychloride plant, as well as lab sewage, so that the emissions values are below the sewage limits prescribed.

For this, the sewage is subjected to a two-stage precipitation, in which the metals are sulphidically precipitated and separated. Sulphidic precipitation was selected because the metal sulphides formed are much less soluble than, for example, the corresponding hydroxides. The sewage cleaning plant is designed for 152 m³/d sewage and works continually 24 hours a day. At an average of 300 operating days per year, the operating time for the plant is approximately 7 900 operating hours per year.

Table 3.67: Composition of waste water after treatment at Montanwerke Brixlegg

Parameter	Unit	Emission levels
Flow	m ³ /d	152
pH		7
Filterable material	mg/l	15.2
Arsenic	mg/l	< 0.03
Lead	mg/l	0.03
Barium	mg/l	0.10
Cadmium	mg/l	0.01
Chromium	mg/l	0.01
Copper	mg/l	0.39
Iron	mg/l	0.16
Nickel	mg/l	0.12
Mercury	mg/l	< 0.001
Silver	mg/l	0.006
Zinc	mg/l	0.4
Tin	mg/l	0.01
COD	mg/l	120
AOX	mg/l	0.11
<i>Source: [378, Industrial NGOs 2012]</i>		

For the cleaning of the surface water and rainwater at Montanwerke Brixlegg, two sedimentation basins are installed at the plant. The operational data of the sedimentation basins are best shown by the reduction of pollution. With a retention time of 30 minutes, almost 90 % of the sediment is eliminated. Oil is also eliminated.

At Umicore Hoboken), a complex smelter treating lead, copper and primary and secondary raw materials containing precious metals, the WWTP consists of three circuits (A, B and a sewer: each of them first perform a separate treatment, and then A, B and part of the sewer water undergo an additional treatment before discharge):

External WWTP A, treating acid process waters with As

The incoming water has a pH of 1, ~ 1 g/l of As and ~ 35 g/l of sulphate in fluctuating concentrations, depending on the processes. Also Tl, Hg, Cd and other metals are dissolved in this water flow.

In a first stage, lime milk and polyelectrolyte are added in order to precipitate gypsum, calcium fluoride and metal hydroxides at a pH of 10.5–11. As precipitates as calcium arsenate to a level of < 50 mg/l. The sludge is removed in a settler and filtered to a cake, containing up to 50 % water, and a lot of unsellable metals like Cd, Tl and As. It is disposed of in a safe deposit.

In a second stage, FeCl₃, lime milk and NaHS are added in order to further remove As, Tl⁺ and other metals at a pH of 10. As in this stage the water of the external WWT B is added to the flow, the sludge contains valuable metals. Therefore this sludge is filtered and returned to the smelter.

After this stage, the pH is adjusted by an injection of CO₂. Then the water is discharged into the river.

External WWTP B, treating acid process waters without As

The incoming water has a pH of 1, and +/- 35 g/l of sulphate.

In a first stage, lime milk and polyelectrolyte are added in order to precipitate gypsum and metals as hydroxides at a pH of 10.5–11. The sludge is removed in a settler and contains a lot of valuable metals like Cu, Pb, In and Te. Therefore this sludge is returned to the smelter.

The second stage of the treatment is described above.

Internal WWTP treating sewer waters

The incoming water consists of rainwater, excess sprinkling water, contact cooling water, some process waters and it is collected in a plant-wide sewer system. The sewer water has a pH of +/- 9 and contains a lot of coarse, suspended particles. It passes first through a sieve, removing bigger particles. Then it flows into a large basin where the particles settle. They are removed by a rake, filtered as a cake and returned to the smelter.

Then the water is treated with sodium hydroxide and polyelectrolyte in order to precipitate the metals. This water is then reused in the plant for sprinkling, cooling, industrial cleaning and some processes. Water not reused is pumped to the second stage of the External WWTP A, in order to lower the salt content of the internal water loop.

The quality of the discharged water, with ranges between the 90th and 100th percentile values of the measured 24-hour averages, is given in the table below.

Table 3.68: Composition of waste water before and after treatment at Umicore Hoboken

Parameter	Unit	WWTP A incoming levels	WWTP B incoming levels	Internal WWTP incoming levels	Emission levels
Flow	m ³ /yr	Not reported	Not reported	Not reported	1 000 000
pH		~ 1	~ 1	9	7.5
H ₂ SO ₄	g/l	35	35	Not reported	2.2–2.6
Cu	mg/l	0.08–2.450	0.1–2.900	0.03–37	0.03–0.05
As	mg/l	0.9–10.000	0.2–2.600	0.1–24	0.16–0.17
Pb	mg/l	1.8–1.000	0.4–4.500	0.1–33	0.03–0.04
Ni	mg/l	0.03–450	0.4–270	0.1–27	0.04–0.05
Zn	mg/l	0.1–4.400	0.05–1.100	0.03–8	0.04–0.05
Cd	mg/l	0.2–3.100	0.01–1.850	0.003–75	0.010–0.011
Suspended solids	mg/l	Not reported	Not reported	Not reported	6.5

NB: Incoming concentrations are minimum–maximum values.
Source: [378, Industrial NGOs 2012]

The waste water of Metallo-Chimique Beerse (a mixture of sanitary water, process water, cooling water and rain/surface run-off water) is centralised. Here the coarse settling fraction is regularly removed and stored in a drainage basin. The sludge is reintroduced into the production process. In the waste water treatment plant, all the water is subjected to a physico-chemical purification process before it is reused or drained. The following steps occur:

- addition of iron trichloride;
- addition of lime milk;
- addition of polyelectrolyte.

Suspended particles are removed from the waste water by a settler. The sludge is removed using a press filter. The dewatered cake is reintroduced into the production process. Before being discharged, the water is filtered by a sand filter and the pH is adjusted by the addition of CO₂. The total inlet conditions of the WWTP are not monitored, only some separate streams. Regular samples are taken and analysed to supervise the WWTP. The sampling period is different for different parameters.

Table 3.69: Composition of waste water after treatment at Metallo-Chimique Beerse

Parameter	Unit	Emissions levels *
Flow	m ³ /yr (2011)	209 902
Flow	m ³ /d	307–337
Cu	mg/l	0.0257–0.044
Cd	mg/l	0.001–0.0018
Pb	mg/l	0.02–0.029
Zn	mg/l	0.0232–0.066
Ni	mg/l	0.056–0.075
As	mg/l	0.0178–0.0207
Hg	mg/l	< 0.0002
* Based on five 24-hour flow-proportional samples in 2011. Source: [378, Industrial NGOs 2012]		

KGHM Głogów 1, 2 and Legnica produce the following streams of waste water.

- Sanitary effluents from canteens, laundry facilities, social and office buildings, etc., discharged to a separate sanitary system.
- Acidic waste water, including waste acid, bleeds from the converter off-gas treatment and rainwater from around the sulphuric acid plant, and waste water from electrolyte purification, the water demineralisation plant and the laboratory.
- Industrial effluents, which include bleeds from cooling water circuits and wet dedusting systems, waste water from washing floors, roads and other objects, as well as rainwater, are discharged into an industrial waste water system. (At Głogów 2, there is a separate sewer for rainwater).

All waste waters are subject to treatment in a waste water treatment plant. First, the acidic streams are neutralised with lime milk, sewage is pretreated in Imhoff tanks and rainwater is stored in retention tanks. Then all the streams are mixed and coagulated with the aid of an iron compound, lime milk, and polyelectrolyte. The sludge separated in the waste water treatment plant precipitates in settling tanks, and is then filtered and landfilled.

Table 3.70: Composition of waste water after treatment at Legnica, Głogów 1 and 2

Parameter	Unit	Legnica		Głogów 1 and 2		Max. values according to permits for Legnica, Głogów 1 and 2
		Emission levels *	Monitoring frequency	Emission levels *	Monitoring frequency	
Flow rate	m ³ /d	6082	Continuous	11 175	Continuous	23 250
pH		8.4	Once a day	8.1	Once a day	6.5–9.0
Cu	mg/l	0.23	Once a month	0.031	3 times per week	≤ 0.5
As	mg/l	0.055	Once a month	0.022	3 times per week	≤ 0.1
Pb	mg/l	0.09	Once a month	0.148	Once every 2 months	≤ 0.5
Ni	mg/l	0.067	Once a month	0.063	Once every 2 months	≤ 0.5
Zn	mg/l	0.428	Once a month	0.037	Once every 2 months	≤ 2.0
Cd	mg/l	0.002	Once a day	0.0037	Once a day	≤ 0.4
Hg	mg/l	0.003	Once a day	0.0005	Once a day	≤ 0.06
Cr	mg/l	0.011	Once a month	0.012	Once every 2 months	≤ 0.5
Suspended solids	mg/l	7.41	Once a month	2	3 times per week	≤ 35

* Yearly average.
Source: [378, Industrial NGOs 2012]

The waste water treatment plant of Atlantic Copper treats effluents mainly from the slag cleaning electric furnace gas scrubber, regeneration of ion exchange resins from the demineralisation plant, the concentrates storage area, and the fire refining gas scrubbers' bleed. The plant has three receiving tanks, and a bladed thickener in which pH adjustment and the addition of coagulants, flocculants and reagents are performed. The overflow from the thickener is passed to a second precipitation and decantation step with reagents added, including iron chlorides for the fine cleaning to remove the remaining arsenic and metals. The overflow from the latter is sent to two tanks and the water is recycled to the electric furnace off-gas scrubber. Excess water is discharged. Slimes from the precipitation steps are sent to a filter press.

Weak acid from the acid plant and bleed from the electrolytic refinery are collected and processed in a multistage chemical water treatment plant (gypsum plant) consisting of three stages:

- gypsum precipitation (micro-filtration and treatment with lime milk, adjusting the pH to around 1);
- then the acid is neutralised with lime milk to pH 1–1.4 and, by precipitation, clean gypsum is produced in a vacuum filter with > 96 % CaSO₄·2H₂O;
- metal precipitation (treatment with lime milk, FeCl₃, increase the pH up to 12, and capture of metals).

At this stage, the pH of the solution increases to near 12 and, in order to precipitate more metals, the necessary reagents for oxidation and precipitation of arsenic and metals are also fed in, including ferric chloride. During the precipitation and decantation of the solid phase in a

thickener, a sludge is produced that is sent to a filter press to produce a neutralisation cake. The precipitation is accelerated with polyelectrolytes (coagulants and flocculants).

Arsenic removal involves treatment with FeCl_3 to capture the remaining arsenic. In this stage, the arsenic that is left in the solution is removed and the pH of the final solution of the treated waters is kept between 7 and 8. Necessary reagents, including ferric chloride, are fed into the solution for the fine cleaning to remove the remaining arsenic and metals in two tanks and a clarifier.

Slimes from this precipitation step are sent to the metal precipitation.

Table 3.71: Composition of waste water before and after treatment at Atlantic Copper

Parameter	Unit	Maximum inlet	Emission levels		
			Min.	Avg.	Max.
Flow rate	m ³ /yr			200 000	
Cu	mg/l	2000	0.02	0.05	0.21
As	mg/l	10 000	0.02	0.3	2
Pb	mg/l	300	0.03	0.04	0.08
Ni	mg/l	4000	0.02	0.04	0.13
Zn	mg/l	5000	0.16	0.67	2.15
Cd	mg/l	500	0.01	0.03	0.09
SS	mg/l	1500	5	16	100
Hg	mg/l		0.015	0.015	0.015

Source: [378, Industrial NGOs 2012]

Discharged water is monitored based on composite 24-hour, flow-proportional samples. Sampling is performed by an automatic sampler.

Boliden Harjavalta operates copper and nickel smelters. Contaminated water (rainwater, snowmelt water, surface drainage and process water) are processed in the waste water treatment plant and then returned to the river. Boliden treats part of Norilsk Nickel's surface and waste area waters. Boliden Harjavalta started the new waste water treatment plant in 2009. The investment cost was about EUR 4 million. Annual operational expenses are about EUR 800 000.

Boliden's waste water treatment plant consists of the following:

- Primary settling.
- Precipitation: metals are precipitated as metal hydroxides with sodium hydroxide (pH approximately 10.5).
- Actiflo© treatment, which is a four-stage process:
 - o Ferric sulphate (coagulant) is added. The coagulant neutralises the surface charges of the metal hydroxide particles and enhances the formation of the primary particles.
 - o Microsand is injected into the stream and mixed to form a uniform solution. Microsand attaches to the floc and increases its weight thus improving the settling velocity.
 - o Flocculant is added to the stream. The flocculant binds the metal hydroxide particles together, forming large flocs with good settling properties.

- o Heavy flocs are settled to the bottom of the settler and clear water leaves the settler as the overflow. The settlers are equipped with lamellae to improve the separation. The sludge from the bottom of the settler is pumped to hydrocyclones, which separate the sand and return it back to the process. The metal sludge is removed via the primary settling, from where it is pumped to the sludge basin and transported to the slag concentration plant.

Table 3.72: Composition of waste water before and after treatment at Boliden Harjavalta

Pollutant	Unit	Inlet	Outlet	
		Avg.	Avg.	90 th percentile
Flow rate	m ³ /yr		2 426 300	
Cu	mg/l	3.356	0.115	0.120
Ni	mg/l	5.448	0.146	0.170
Zn	mg/l	1.805	0.031	0.040
Pb	mg/l	0.092	0.009	0.008
As	mg/l	0.474	0.053	0.120
Cd	mg/l	0.272	0.006	0.010

Source: [378, Industrial NGOs 2012]

At Boliden Rönnskär, the different process waters from all the production units (copper smelter, converters, electrolyser, Zn-fuming plant, lead plant, acid plant, PM plant) are mixed with rainwater and rinse water, after first being collected in different pools. The treatment process consists of two steps. In the first step, metals and arsenic precipitate at pH 2–4 in reaction tanks with sulphide, the sulphide slime is separated in a thickener and recycled to the copper process. The second step consists of precipitation with lime, wherein calcium fluoride is precipitated. The lime mud is landfilled.

Table 3.73: Composition of waste water after treatment at Boliden Rönnskär

Parameter	Unit	Emission *		
		Minimum	Average	Maximum
Flow rate	m ³ /yr	NR	NR	NR
Cu	mg/l	0.003	0.031	0.46
Pb	mg/l	0.001	0.009	0.043
Zn	mg/l	0.01	0.48	12
Cd	mg/l	0.0002	0.002	0.013
As	mg/l	0.005	0.23	1.1
Hg	mg/l	0.00005	0.0003	0.0014

* Values based on 12 samples a year.
 NB: NR = Not reported.
Source: [378, Industrial NGOs 2012]

At Cobre Las Cruces, the purge from the solvent extraction process (hydrometallurgical process) is treated in a waste water treatment plant. In this plant, a physico-chemical treatment is carried out consisting of a two-stage process involving neutralisation and oxidation, followed by thickening and filtering. Lime dosing and other additives (flocculants) are also used. The waste water from this treatment is monitored before discharge into the receiving water.

Table 3.74 shows emissions measured in 2011.

Table 3.74: Composition of waste water after treatment at Cobre Las Cruces

Parameter	Unit	Emission *		
		Minimum	Average	Maximum
Flow rate	m ³ /yr	NR	NR	NR
TVOC	mg/l	4.1	5.8	9
Cu	mg/l	0.004	0.04	0.0554
Pb	mg/l	0.0025	0.006	0.006
Zn	mg/l	0.021	0.106	0.123
Cd	mg/l	0.0005	0.003	0.005
As	mg/l	0.017	0.03	0.059
Hg	mg/l	0.0005	0.001	0.0015

* Values based on 303 measurements per year (24-hour composite samples).
 NB: NR = Not reported.
 Source: [358, CLC 2012.]

Cross-media effects

- Production of waste for disposal.
- Increase in energy use.
- Use of reagents, e.g. precipitation chemicals or biocides for cooling water make-up.
- Water recycling or reuse is limited in many cases by the solution's conductivity.
- Noise, e.g. arising from cooling towers.
- Transfer of heat from water to air.
- Possible propagation of legionella in closed systems at temperatures between 25 °C and 60 °C.

The techniques to be applied have to take into consideration the specificity of the production processes and the local conditions. Also, the size and the flow rate of the receiving water body can play a role in the choice of techniques.

Reducing the volume flow in favour of higher concentrations requires less energy for the treatment. Treating highly concentrated waste waters will result in higher effluent concentrations but with a better reduction rate than lower concentrated flows, giving an improved overall removal of pollutants.

The use of cooling-water circuits is energy-consuming and needs chemical additions, thus cooling water from rivers or lakes, where available, is less expensive.

The contact of sulphides with an acid must be avoided in order to prevent the formation of hydrogen sulphide. Ferric sulphate can be added after precipitation to remove the excess sulphide.

Economics

Aurubis Pirdop's investment costs were EUR 10 million; electricity: 220 kWh, consumption of lime: 0.74 t/t of acid, FeCl₃: 8.4 t/t of arsenic, H₂O₂: 2 t/t of arsenic.

Driving force for implementation

Reduction of waste water emissions, driven by regulatory requirements.

Example plants

Aurubis Hamburg (DE) (primary copper smelter, secondary copper/lead smelter, precious metals production, copper processing); Aurubis Pirdop (BG) (primary smelter); Aurubis Olen (BE) (secondary smelter, copper processing); Umicore Hoboken (BE) (complex smelter); Metallo-Chimique Beerse (BE) (secondary copper); Montanwerke Brixlegg (AT) (secondary

copper smelter; WWTP for hydrometallurgical production; two sedimentation basins for surface water); KGHM Głogów 1, Głogów 2 and Legnica (PL) (primary copper smelters); Atlantic Copper (ES) (primary copper smelter); Cobre Las Cruces (ES) (hydrometallurgical); Boliden Harjavalta (FI) (primary copper smelter); and Boliden Rönnskär (SE) (primary copper smelter, secondary copper/lead smelter, precious metals production).

Reference literature

[238, ECI 2012], [383, Copper subgroup 2012]

3.3.7 Process residues

3.3.7.1 Use or treatment options for process residues

Description

The techniques to consider, in order or priority, are:

- reuse in the smelting process to recover copper and other metals;
- recovery of metals in external plants;
- treatment for other useful applications.

Technical description

A broad range of intermediates are formed during copper production depending on the processes applied and the raw materials used. Due to this variety of by-products, differing from each other in physical appearance and chemical composition and variable in time, this section includes a description of potential uses, though these may not be appropriate in all circumstances. A solution should be defined for all intermediates, in line with the above order of preference.

Most of the intermediate products generated during copper production contain recoverable quantities of copper and other non-ferrous metals and are therefore used as secondary raw materials. Flue-dusts from all sources can be reused in the smelting process or sold to third parties. To prevent dust formation during handling, they are carefully handled, usually in specially designed systems, or they are already pretreated for the further processing requirements.

Some furnace linings can also be reused as taphole mass or introduced into the smelting processes together with the raw materials, and so can be incorporated in the slag. In other cases, the lining is disposed of.

Final iron silicate slags produced by furnaces, the fuming plant or from flotation contain very low levels of leachable metals and are stable. Slags are used as material for different industrial applications and to replace natural sources, such as the sub-base layer or surface layer in road construction, aggregate for embankment construction, mine backfill, concrete applications and other fill applications, clinker production, or as a mineral addition to blended cements, or as an abrasive blasting agent.

Final slags are produced in different grain sizes, i.e. coarse lumpy, granules, down to finer grain material, depending on the process and applications. They have excellent mechanical properties, which are sometimes superior to those of competing natural minerals.

The techniques applied in order to reduce the quantities of waste sent for disposal are reported in Table 3.75 below.

Table 3.75: Intermediates, residues and wastes from the production of copper

Process unit	Production residue	Use/Treatment technique
Abatement systems In all metallurgical processes	Dust (including slime from wet dedusting systems)	Metal recovery by pyrometallurgical or hydrometallurgical processes. Gypsum for sale. Reuse in pyrometallurgical processes as source of calcium.
	Spent catalysts	Recycling/Regeneration
	Sulphuric acid	Sale for various applications
	Weak acid	Other uses, e.g. leaching, gypsum production
	Residues from mercury removal systems	Treatment or safe disposal
Smelting furnaces	Slag Final slag	Treatment in slag furnace or slag flotation plant. Application as a sub-base layer or surface layer in road construction, aggregate for embankment construction, concrete applications and other filling applications, clinker production or mineral addition to blended cements, or as an abrasive blasting agent.
	Furnace linings	Recovery of metals or reuse as refractory or controlled disposal
Converters	Slag	Recovery of metals
	Furnace linings	Recovery of metals or reuse as refractory or controlled disposal
Slag furnaces/fuming plant	Final slag	Application as a sub-base layer or surface layer in road construction, aggregate for embankment construction, concrete applications and other filling applications, clinker production or mineral addition to blended cements, or as an abrasive blasting agent
Slag flotation	Final slag	Industrial applications in road construction, concrete and other filling applications, for clinker production or as a mineral addition to blended cements or as a component for iron/steel production. Controlled disposal in tailings area.
Refining (anode) furnaces	Slag	Recovery of metals
Melting furnaces (copper processing)	Refractory lining	Recovery of metals or controlled disposal
	Skimmings, slags	Recovery of metals
	Production scrap	Recovery of metals
Tank house	Spent electrolyte/bleed	Recovery of Cu by electrolysis, cementation or other techniques. Recovery of Ni by crystallisation. Reuse of remaining acid to make up new electrolyte, for gypsum production or neutralisation and

		disposal.
	Spent anodes	Internal recycling by remelting or application as cooling material during pyrometallurgical copper refining
	Anode slime	Precious and base metals recovery
Waste water treatment	Clean gypsum	Reuse in pyrometallurgical processes as a source of calcium or sale as by-product
	Contaminated gypsum	Disposal in specially designed landfills
	Sludge	Metal recovery by pyrometallurgical or hydrometallurgical processes, or safe disposal as waste
Hydrometallurgy	Depleted electrolyte	Reuse as leaching agent
Semis production	Acid pickling solutions	Metal recovery by electrolysis, ion exchange, precipitation or other methods. Reuse of the solution or discharge after waste water treatment.
Rod production	Acid pickling solutions (if applied)	Metal recovery by electrolysis, ion exchange, precipitation or other methods. Reuse of the solution or discharge after waste water treatment.
	Scale	Copper recovery by pyrometallurgical processes

Source: [238, ECI 2012], [383, Copper subgroup 2012]

Achieved environmental benefits

- Minimisation of material destined for disposal.
- Reuse of resources and recovery of valuable metals.
- Natural resources savings (final slag applications).

Environmental performance and operational data

No information provided.

Cross-media effects

No information provided.

Technical considerations relevant to applicability

The techniques described in this section can be used in all plants depending on the physico-chemical characteristics of the intermediates. Techniques used at factory level depend on specific local conditions, the raw materials and the combination of processes used.

Economics

No information provided.

Driving force for implementation

- Environmental regulation requirements.
- Economic considerations.

Example plants

All plants.

Reference literature

[238, ECI 2012], [383, Copper subgroup 2012]

3.3.8 Energy**3.3.8.1 Technique to reduce energy consumption in primary copper production****Description**

The techniques to consider are:

- optimising energy consumption;
- online monitoring;
- reporting and analysis tools;
- regular audits.

Technical description

Some of the techniques are applied in both primary and secondary copper production.

Optimising energy consumption

- Use of regenerative burners, recuperative burners, heat exchangers and waste heat boilers to recover heat.
- Preheating of the fuel gas and combustion air. The heat of the off-gases can also be used to heat combustion air and gas through a heat exchanger.
- Use of a flash smelting furnace reduces the consumption of standard fuels due to the optimum utilisation of the heating value of the sulphidic concentrates and organic carbon present in copper concentrate.
- Oxygen enrichment of combustion air for smelting decreases the consumption of fossil fuels and associated direct emissions. Waste gas volumes also decrease thus allowing the use of smaller fans. Oxygen manufacture requires the use of electricity, so a careful energy and emissions balance must be made.
- Use of appropriate furnace lining and insulation at installations using high temperatures, such as insulation of steam pipes and hot water pipes.
- Hot process gases from the melting stages can be used to heat up the incoming charge, depending on the type of furnace used, e.g. shaft furnace.
- Covering the concentrates during transport and storage prevents excess moisture accumulating in the charge, while also preventing dust.
- The separate drying of concentrates at low temperatures reduces the energy requirements, as it reduces the energy required for the evaporation of water in the smelter and the volume of steam/gas produced.
- Use of waste heat boilers to recover energy and to produce steam. This steam is used for heating process air or concentrate dryers, driving smelter blowers or compressors, generating electricity, or as process heat for other plants.
- Use of the excess heat produced during primary smelting or converting stages to melt secondary materials without the use of additional fuel. For example, the heat in the PS converters is used to melt scrap.
- The production of sulphuric acid from the sulphur dioxide emitted from the roasting and/or smelting stages is an exothermic process and involves a number of gas-cooling stages. The heat generated in the gases during conversion, and the heat contained in the acid produced, can be used to preheat the gas directed to the sulphuric acid plant or to generate steam and/or hot water.
- Use of concentrates containing carbon lead to high carbon monoxide in exhaust gases. This is collected and burnt as a fuel (in a local power plant) to produce steam for district heating or for driving electricity turbines, and at the same time to remove this contaminant from the exhaust gases.

- Gases from anode furnaces can be used in drying or other process stages.
- Installation of high-efficiency electric engines, e.g. for fans, equipped with a variable-frequency drive.
- The insulation and covering of electrolysis tanks decreases heat losses and the consumption of heat necessary to maintain the temperature.

Online monitoring

This is often used for the most important energy flows and combustion processes at the site. The data are stored for a long time, so that typical situations may be analysed.

Reporting and analysing tools

Reporting tools are often used to check the average energy consumption of major processes. An energy-controlling system that monitors the energy used offers the possibility of comparing actual data with historical data.

Energy audits

These audits are a crucial tool to identify cost-effective energy savings opportunities.

Achieved environmental benefits

Minimisation of energy consumption.

Environmental performance and operational data

At Aurubis Hamburg and Pirdop, a waste heat boiler is used to recover heat from concentrate flash smelting. Steam is used for concentrate steam dryers, in the tank house and for heating purposes for the different chemical processes, as well as for building heating purposes. Heat generated in converters is used for the melting of scrap. In the double contact/double absorption acid plant, heat exchangers recover the heat from the production of H₂SO₄ from SO₂.

At KGHM Głogów 1 and Legnica, the gases from the shaft smelting furnaces (containing around 10 % CO) are directed to local power plants for incineration, to eliminate CO and recover energy. The extraction gases from the charging and tapping sections of the shaft furnaces are used as combustion air in the local power plants.

At Głogów 1, Głogów 2 and Legnica, heat generated in the converters (in primary production) is used for the melting of scrap (which may be added to the batch).

At Głogów 1, Głogów 2 and Legnica, in sulphuric acid plants, heat exchangers recover the heat from the conversion process and use it to preheat the gas directed to the sulphuric acid plant.

At Legnica, ventilation gases from the loading, tapping and slagging sections of anode furnaces are partially used as air for combustion in the burners of the anode furnaces. The heated air in the pipes of the atmospheric coolers of the converters is utilised for heating the dedusted flue-gas from the shaft furnaces which was transferred to the power plant for incineration.

At Głogów 2, the waste heat boiler is used to recover heat from the flash smelting of concentrate for the production of steam and hot water.

Steam produced in the power plants and waste heat boilers (amongst other sources) is utilised for electrolyte heating, unloading of black liquor and, in Legnica, in the stripping tower of the polyether-based absorption/desorption process.

At Boliden, a waste heat boiler recovers heat from the smelting and converting of concentrate. Waste heat is used in concentrate drying in order to save energy and reduce SO₂, gas and dust emissions from the drying process. A part of the hot anode furnace off-gases is used in the drying of concentrates.

At Atlantic Copper, a waste heat boiler recovers heat from concentrate smelting. Steam is used for the drying of concentrates, heating purposes in the plant, and for the production of electricity. Converters' process heat is used for scrap melting. Combustion gases from the power plant are also used for concentrates drying. An energy management system pursues continuous energy efficiency improvement.

Cross-media effects

Measures to reduce the moisture content of materials should be balanced with the need to maintain a certain moisture content in materials in order to prevent dust emissions.

Technical considerations relevant to applicability

These techniques are applicable depending on the type of furnace, the abatement techniques used, the fuel availability, the composition of raw materials and the age of the installation. For example, the use of waste heat boilers using hot gases produced during the smelting of sulphidic ores is commonly applied. Special care should be taken to prevent the effects of high dust loads and corrosion.

The use of off-gases to recover energy in power plants is applicable for gases with high concentrations of carbon monoxide (around 10 % CO).

In some cases, the dust content of the off-gases prohibits the use of heat exchangers.

Cooling prior to a bag filter is important as it protects the filter against high temperatures.

Economics

The measures discussed above require significant investments (e.g. for insulation/lining materials) but these are recovered in the long term.

Driving force for implementation

Minimisation of energy costs.

Example plants

Aurubis Hamburg (DE), Aurubis Pirdop (BG), KGHM Głogów 1, Głogów 2 and Legnica (PL), Boliden Rönnskär (SE), Boliden Harjavalta (FI), and Atlantic Copper Huelva (ES).

Reference literature

[238, ECI 2012] [383, Copper subgroup 2012]

3.3.8.2 Technique to reduce energy consumption in secondary copper production

Description

The techniques to consider are:

- optimising energy consumption;
- online monitoring;
- reporting and analysis tools;
- regular audits.

Technical description

Some of the techniques are applied in both primary and secondary copper production.

Optimising energy consumption

- Use of regenerative burners, recuperative burners, heat exchangers and waste heat boilers to recover heat.
- Reducing the water content of feed material. Predrying raw materials reduces the energy consumption during smelting, since evaporation of water at low temperature requires less energy than high-temperature processing. These measures need to be balanced with the need to maintain a certain moisture content in materials in order to prevent dust emissions.
- Use of effective furnace lining and insulation at installations using high temperatures. Insulation of steam pipes and hot water pipes.
- Preheating the fuel gas and combustion air. The heat of off-gases can also be used to heat combustion air and gas through a heat exchanger.
- Hot process gases from the melting stages can be used to heat up the incoming furnace charge, depending of the type of furnace. An example is the use of a shaft furnace, where charge preheating takes place within the furnace.
- Recirculation of waste gases through an oxy-fuel burner results in significant energy savings. The burner recovers waste heat from the gas, and uses the energy content of the contaminants and removes them.
- Use of a RTO as an afterburner reduces the energy needed for the reduction of organic carbon emissions.
- Use of a holding furnace for the batch-wise operated smelter when a buffer capacity is required between process stages. Due to the batch-wise operation and the difference in the duration of the process cycles of equipment at different stages (e.g. smelting furnaces, converters, anode furnaces), the metal has to be kept in the molten state in the meantime. Otherwise, the black copper or converter copper has to be remelted for use in the downstream furnace/converter, which involves far higher energy consumption.
- Oxygen enrichment of combustion air for smelting decreases the overall consumption of fossil fuels and associated direct emissions. Waste gas volumes also decrease thus allowing the use of smaller fans. Oxygen manufacture requires the use of electricity, so a careful energy and emissions balance must be made.
- Installation of high-efficiency electric motors, e.g. for fans, equipped with a variable-frequency drive.
- Use of waste heat boilers (WHB) to recover energy and to produce steam. This steam is used for heating process air or steam dryers, driving smelter blowers or compressors, generating electricity, or as process heat for other plants;
- Steam produced by recovering excess heat from an anode furnace is used to heat the electrolyte in refineries and/or to produce electricity in a co-generation installation.
- The insulation and covering of electrolysis tanks decreases the heat losses and decreases the consumption of heat necessary to maintain the temperature.

- Use of the excess heat produced during smelting or converting processes to melt different qualities of scrap without the use of additional fuel.
- Use of recycled copper in the smelting process to improve the energy balance proportionately. Due consideration has to be given to variations in the quality and availability of secondary materials.
- During the smelting of electronic scrap, the combustible plastic content contributes to the energy that is used in the smelting process and reduces the amount of fossil fuel needed.

The energy required to smelt a certain feed strongly depends on the composition, so the charge composition could be optimised to generate maximum exothermic heat. This however is not regarded as a preventive measure to reduce energy consumption, because the composition of a secondary material depends on the foregoing processes, on the market availability of input materials and on the abatement system installed.

Online monitoring

This is often used for the most important energy flows and combustion processes at the site. The data are stored for a long time, so that typical situations may be analysed.

Reporting and analysing tools

Reporting tools are often used to check the average energy consumption of major processes. An energy-controlling system that monitors the energy used offers the possibility of comparing actual data with historical data.

Energy audits

These audits are a crucial tool to identify cost-effective energy savings opportunities.

Achieved environmental benefits

The aim of energy optimisation is to minimise the energy consumption within the inherent constraints of the system, and to thereby decrease the associated direct and indirect emissions.

Cross-media effects

- Electronic scrap processing will require extra environmental compliance equipment.
- Measures to reduce the moisture content of materials should be balanced with the need to maintain a certain moisture content in materials in order to prevent dust emissions.

Environmental performance and operational data

At Aurubis Lünen, heat from the KRS and anode furnace is recovered in a WHB and used for electrolyte heating.

At Aurubis Olen, in the Contimelt plant, hot gases from the ASO shaft furnace are used to preheat the charge, and the waste heat boiler produces steam. In the Contirod plant, the feed (copper cathodes) of the Asarco furnace is preheated by the exhaust gases in the furnace shaft. Exhaust gases preheat the combustion air for the burners through a heat exchanger. A closed loading system prevents heat/gases escaping from the installation. Waste heat from the extrusion line of the Conform installation is reused for heating the production building.

At Aurubis Avellino, waste heat from the shaft furnace is recovered to preheat natural gas.

At Umicore Hoboken, the water content of the smelter feed is reduced as much as possible by mixing dry raw materials with wet ones, instead of using additional water. The input of electronic scrap in the smelter is maximised. High-efficiency electrical engines for fans, pumps, etc. and variable-frequency drives are installed. Insulation is used for the furnace and the steam boiler. The temperature of the process is monitored and the energy feed is adjusted to minimise the energy use. In the electrowinning plant, a high electrical efficiency of > 95 % is maintained.

At Montanwerke Brixlegg, a waste heat boiler recovers heat from the off-gas of the anode furnace; a RTO is used for the off-gas from the shaft furnace.

Technical considerations relevant to applicability

Among the reduction techniques listed, selected techniques and measures will be applicable depending on the type of furnace, the abatement techniques used, the fuel availability, the composition of raw materials and the age of the installation.

For example, in some cases, the dust content of the off-gases prohibits the use of heat exchangers. Cooling prior to a bag filter is important, as it protects the filter against high temperatures. This means that a temperature gap between radiation as a method for heat recovery (+/- 600 °C) and the inlet of a filter system has to be bridged, by water injection, to further cool the gases.

Economics

The measures discussed above require significant investments (e.g. for insulation/lining materials), but these are recovered in the long term.

Driving force for implementation

Minimisation of energy costs.

Example plants

Aurubis Lünen (DE), Aurubis Olen (BE), Aurubis Avellino (IT), Umicore Hoboken (BE), and Montanwerke Brixlegg (AT).

Reference literature

[238, ECI 2012], [383, Copper subgroup 2012]

3.4 Emerging techniques

Bath smelting

It has been reported [135, Gershel, T. 1998], that activity is taking place in the development and improvement of bath smelting techniques. Bath smelting can offer low-cost installations because of the potentially high reaction rates in modern plants coupled with sealed or semi-sealed furnaces. Plant reliability should be proven in the long term and, if they become available, data from some of the Chinese and Russian installations using Baiyin or Vanyukov furnaces should be examined. The emerging techniques are shown in Table 3.76.

Table 3.76: Emerging bath smelting techniques

Technique	Comments
Continuous smelting/converting: Combination of Noranda reactor and Mitsubishi converter furnace	Results of commissioning in 1999 awaiting evaluation

Hydrometallurgical process

The use of hydrometallurgical processes such as bioleaching is also emerging and they are suitable for mixed oxidic/sulphidic ores that contain low concentrations of precious metals. Iron- and sulphide-oxidising bacteria may be used to assist leaching.

The Outotec HydroCopper® process

The Outotec HydroCopper® process that uses a chlorine-based leaching system is available at a demonstration plant scale. Some processes are being developed for concentrates and dust treatment based on leaching, for example leaching-solvent extraction-electrowin (L-SX-EW) processes, [308, Haavanlammi 2007], [309, Pekkala 2007].

4 PROCESSES TO PRODUCE ALUMINIUM FROM PRIMARY AND SECONDARY RAW MATERIALS INCLUDING THE PRODUCTION OF ALUMINA AND ANODES FABRICATED FOR ALUMINIUM PRODUCTION

4.1 Applied processes and techniques

4.1.1 Alumina

Alumina is usually produced from bauxite in the well-established Bayer process as shown in Figure 4.1. This process utilises the different thermodynamic properties of the caustic soda - aluminium hydroxide system. There are three main aluminium-based compounds in bauxite: aluminium oxide trihydrate (gibbsite), γ -aluminium oxide monohydrate (boehmite) and α -aluminium oxide monohydrate (diaspore). The solubility of each form of aluminium oxide hydrate is heavily dependent on the temperature. Hence, in the Bayer process, aluminium compounds dissolve in the digestion area at temperatures of up to 280 °C, and at lower temperatures the dissolved aluminium hydroxide is precipitated as solid material in the precipitation area, i.e. at around 55–70 °C and, thus, the aluminium compounds can be removed from the process.

In this process, caustic soda flows in a circuit and is fed with ground bauxite and then heated up to digestion temperature. The alumina compound of the bauxite dissolves at these elevated temperatures and pressures in the digesters. Afterwards, the undissolved material from the bauxite, i.e. the red mud, is removed from the process by means of thickeners and/or filters. The supersaturated liquor is then cooled down in the presence of fine particles of aluminium oxide trihydrate to induce crystallisation. The aluminium oxide trihydrate (also called aluminium hydroxide) crystallises in the precipitation area and can be removed by filters from the Bayer circuit. A solution of sodium hydroxide is used to dissolve more bauxite and the circuit starts again. In a last process step, the aluminium hydroxide is converted to alumina by calcination.

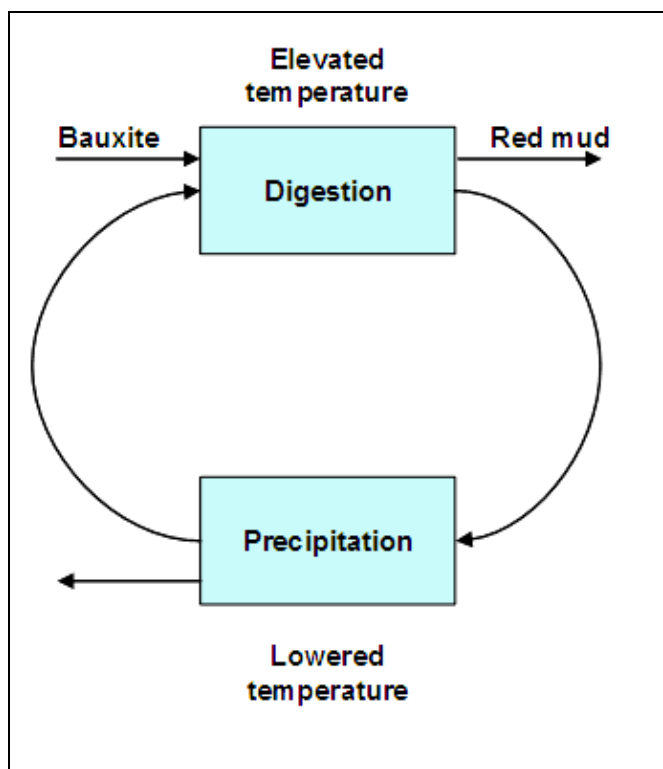

Figure 4.1: General principle of the Bayer process

Although the basic process is standard across the industry, there are variations in the conditions and equipment used, in particular the digesters and calciners. These variations mainly affect the energy used in the process [75, Nordheim, E. 1998].

Digestion

First of all the bauxite is ground in order to make it pumpable and to increase the surface for extraction. The bauxite is ground in ball or rod mills or a combination of both, and caustic soda (liquor) is added. The resultant slurry is then usually stored in slurry tanks. The digesters are fed with this bauxite slurry and additional liquor in order to achieve optimum dissolution properties.

The bauxite slurry is heated up to digestion temperature, which varies from 100 °C to 320 °C depending on the bauxite quality, at which the aluminium compound dissolves. The hot slurry is cooled down in flash tanks. The evaporated steam is used to preheat the bauxite slurry and, thus, heat is recovered. In order to achieve to the final digestion temperature, primary energy is used, either indirectly or directly by the injection of live steam. The condensate is used for various washing purposes, e.g. to remove the soluble caustic from the bauxite residues and aluminium hydroxide.

Due to the reaction taking place during the digestion of soda and silica compounds present in the bauxite, sodalite precipitates and is removed from the process with the bauxite residue. The amount of sodalite depends on the silica content of the bauxite, on the form of the silica and on the extraction conditions. Also, depending on the bauxite quality, lime is added in order to remove vanadium and phosphate from the liquor and to improve the extraction yield.

Red mud or bauxite residue removal

(See also the reference document on the Management of Tailings and Waste-Rock in Mining Activities [332, COM 2009]). Bauxite residue, usually known as red mud, is the remaining solid material after the extraction of the bauxite and it does not dissolve in the liquor. It is removed from the process liquors by means of thickeners. With these thickeners, the flow velocity of the liquor is reduced and the solid residue settles out. Some refineries separate the coarse particles of the residue, known as sand, prior to the thickeners, therefore avoiding erosion in the subsequent stages. This sand is frequently used for road construction within the site.

The separated residue is then washed with condensate, which flows in a countercurrent direction through a washer train. Before each washer, the slurry from the previous washer and the overflow from the subsequent washer are mixed and settle out in the washer. In this way the alkali concentration is reduced in each stage of washing. The more washers that are installed, the lower the final alkali concentration of the bauxite residue.

Improvements in thickener design using deep thickeners have enabled some plants to achieve better control of solid contents and alkali. In some refineries, the last step of recovering the alkali is a filtration stage (this is the most efficient way to aid alkali recovery and final residue dewatering), in which the residue is washed with condensate and the filter cake is stored in a specific disposal area. In this manner, the free alkali concentration can be reduced to a very low level. Either drum filters or plate and frame filters are used, occasionally sequentially. When a high-pressure filtration is used, the solid residue produced has a very low water content and can be stored as a solid or economically transported to be used in various other applications.

Precipitation and calcination

At first, the overflow of the settlers is filtered in order to remove the finest solid particles from the liquor. The liquor is then cooled down to the precipitation temperature and the precipitation is started by adding aluminium hydroxide as the seed. In some Bayer plants, the hydrate slurry flows through a tank cascade where hydrate is precipitated in each tank. At the end of the cascade, the solid hydrate is removed from the liquor by either filtration or thickeners. The separated hydrate is then washed with condensate and can afterwards be calcined. The solid-free liquor, after passing, in some cases, through an evaporation plant, is fed to the digestion area where it runs through the circuit again.

In the calcination stage, the hydrate is heated to temperatures of around 1000 °C. Under these conditions, the aluminium hydroxide is converted to alumina. This process can be carried out in circulating fluidised beds, and stationary or rotary calciners. Circulating fluidised bed calciners are used to make smelter-grade alumina (SGA). Rotary calciners are less energy-efficient than fluidised bed calciners and are generally operated at higher temperatures (1200–1300 °C) to produce an alumina with a higher α -aluminium² oxide content, which is required to produce speciality alumina. A smelter-grade alumina will typically have an α -aluminium oxide content of about 5 %, in comparison to a value of > 95 % for a rotary calcined speciality alumina. Either gas or oil can be used for calcination.

A typical process flow diagram for the Bayer process is shown in Figure 4.2, brackets indicate non-obligatory process steps.

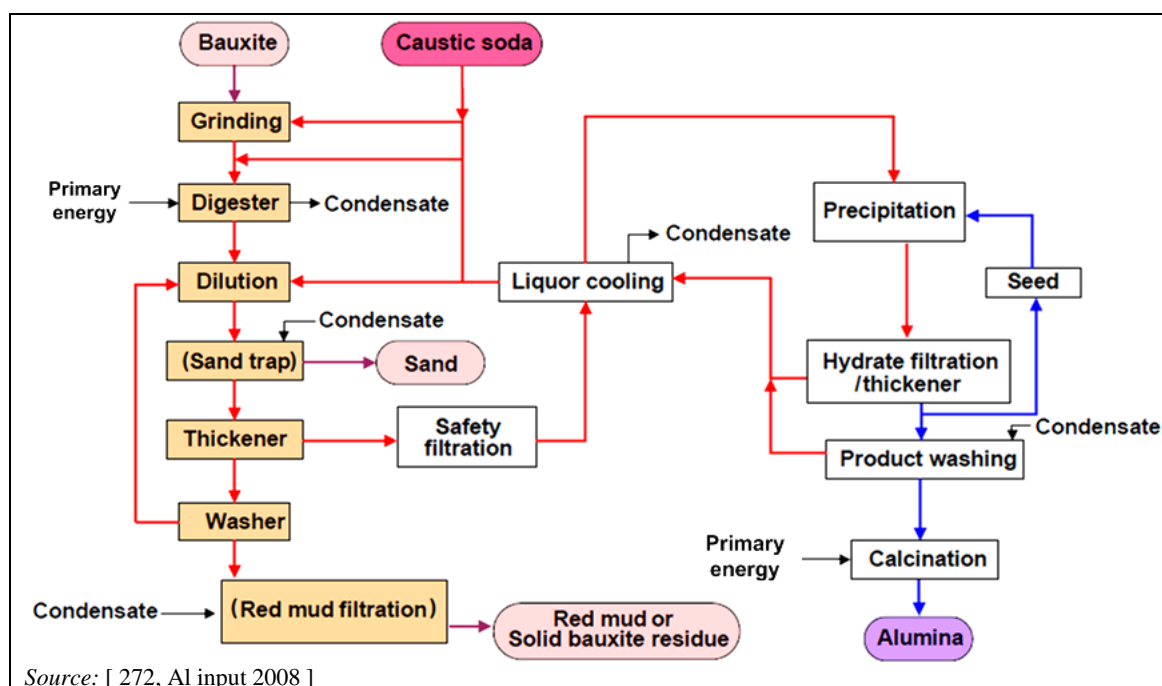

Source: [272, Al input 2008]

Figure 4.2: The Bayer process

Impurities such as oxalate and carbonate from the process are usually removed in side-streams by various techniques. Both salts originate from the digestion stage and come from the organic and carbonate content of the bauxite; in addition, carbonates arise from reaction with carbon dioxide during the process. The salt is generated as a residue or a by-product. If alumina production is based on bauxite that contains high levels of vanadium, the salt can be further used to obtain vanadium pentoxide for the steel industry. This process may have a waste water problem, as the salt also contains arsenic that is transported into the leach liquor and then to the waste water.

4.1.2 Anodes for aluminium production

Carbon anodes produced for primary aluminium smelting are commonly produced on the same site as the smelter itself. In some cases though, they can be produced in stand-alone anode production plants. The production of anodes is similar to the production of carbon and/or graphite electrodes and shapes, but there are significant differences in the percentage of coal tar pitch, the baking temperature and gradient, and other process parameters. Also, anode plants include the recycling of anode butts. A brief comparison is shown in Table 4.1.

² Alpha phase is the most stable crystallographic form of aluminium oxide.

Table 4.1: Comparison of baking processes

Parameter	Anode production	Carbon electrode first baking stage
Baking temperature (°C)	800–1200	800–1100
Pitch content (%)	13–18	Up to 40
Heating gradient (°C/h)	10–14	1–2
Specific gas volume (m ³ /h per tonne produced per year)	5000	50–110
<i>Source: [318, Hagen et al. 2007]</i>		

The production of anodes for the primary aluminium industry is reported here. The production of carbon electrodes is reported in Chapter 10.

Processes use coke, pitch and cleaned anode butts to produce pastes, which are then formed into anode blocks. Raw material storage and handling stages use enclosed coke delivery and handling systems and integral dust filters. Coal tar pitch delivery and storage systems use tank back-venting and condensers for tank breathing when using liquid pitch and silos for solid pitch. In some cases, a catalytic thermal oxidiser (CTO) or regenerative thermal oxidiser (RTO) can be used to treat the gases. There are also other secondary raw materials used, which range from fine dusts to large single items. Secondary raw materials that contain water-soluble components, such as small amounts of fluorides from the recycled products, are stored under cover. Some secondary materials need to be pretreated by media and magnetic separation in order to remove ferrous contamination. Søderberg paste and prebaked anodes are formed and the latter are baked ready for use in appropriate facilities.

The basic process for green anode production is described in Figure 4.3.

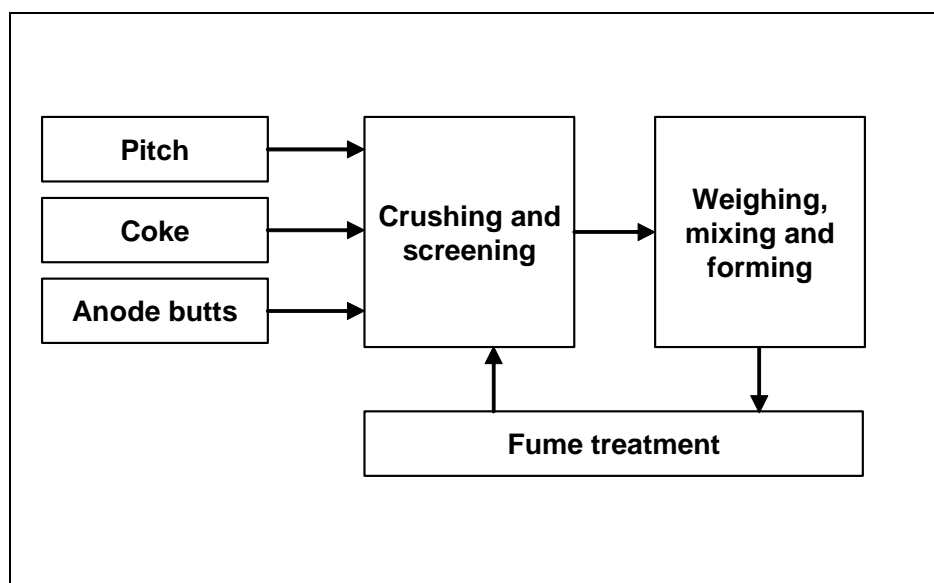

Figure 4.3: Production of green anodes

Production of green paste

Green paste production is the starting point for the production of all carbon anodes. All green pastes are manufactured from a mixture of calcined petroleum coke, cleaned and recycled anode butts, and coal tar pitch which acts as a binder. The petroleum cokes are a residue from the distillation of crude oils and may therefore be contaminated with substances like metals (e.g. nickel) and sulphur compounds.

Coke and solid pitch are normally transferred by sealed conveyors or dense phase pneumatic systems, and are stored in silos. Liquid pitch is transported in a molten state and is transferred

by pumping, and is stored in heated tanks. The tank ventilation gases contain hydrocarbon fume and are usually cleaned in the anode paste plant's pitch vapour treatment system (usually coke dry scrubbers, CTO/RTO, or a combination of these systems). Condensers or oil scrubbers are used [75, Nordheim, E. 1998] and back-venting of the tank gases is also used. Petroleum coke and anode butts are ground, preheated and then mixed with pitch in heated mixers. The ratio of coke to pitch is adjusted according to the application and to allow the paste to be handled and formed into blocks.

In the case of Söderberg paste, the blend is produced to allow it to be added to the anode shell. Dry anode paste (lower pitch content) is preferred, to minimise the amount of hydrocarbons released during use [6, McLellan and Partners Ltd 1993]. Green shapes are formed by pressing the green paste in moulds to create 'briquettes' and are fed at the top of the anode, where the metallic stubs are used for the electrical connection.

Prebaked anodes

These anodes are manufactured from a mixture of petroleum coke and 13–18 % coal tar pitch and residual material from anode butts [75, Nordheim, E. 1998].

Anode production involves crushing, grinding, preheating and mixing of the raw materials. The mixed materials are then formed into green anodes, usually using a vibro-compactor. The green anodes are then baked in ring furnaces comprising a large number of pits which contain the anodes. Refractory brick walls separate the pits. Flue-gases are transferred from pit to pit through refractory bricks' built-in gas channels. Green anodes are stacked in the anode furnace in rows. Layers of packing coke separate the anodes and prevent oxidation. This coke is partially consumed during the heating and cooling cycle at a rate of 12–18 kg per tonne of anode and the remaining coke is reused. At any one time, pits in separate sections of the furnace are being filled, heated, cooled or emptied [91, OSPARCOM 1992].

Hot air is passed through the ducts using movable gas-fired burners, and the anodes are baked at 1100 °C in the absence of air. The ducts are kept under negative pressure to contain the fumes. At the end of the heating cycle the ducts are then connected to blowers to cool the section. Hot air passing from the furnace section being cooled is then recycled through the burners or through other furnace sections to preheat that part of the system.

The layout of baking furnaces is illustrated in Figure 10.6.

Two types of furnace are used for anode baking: open and closed ring furnaces. Open furnaces use a horizontal duct, and closed furnaces use a vertical flue. Open furnaces account for more than 60 % of capacity and are used in new plants. The horizontal ducts of the open furnace are separate and parallel, which allows the heating cycle to be optimised for each duct and so reduces fuel consumption [91, OSPARCOM 1992]. The use of multiple chambers in the furnace allows heat from one section to be used in other sections.

During the baking process, the coal tar pitch is converted into coke, making the material electrically conductive. There is approximately a 5–10 % loss in weight during baking [75, Nordheim, E. 1998] and the baking process takes approximately 14 to 21 days.

In the most common case, anode production taking place at the site of a primary smelter, alumina is used in a dedicated fume treatment centre to clean the fumes by the adsorption of PAH, fluorides from the anode butts, and some VOCs. These techniques are described in Section 4.3.2.3.

In a few rare cases, furnace fumes are combined with the gases from the potline to be scrubbed by alumina in a common gas and fume treatment centre.

Regenerative afterburners (or regenerative thermal oxidisers) are the preferred option for stand-alone anode production plants to treat gases from the baking furnaces. The techniques are described in Section 4.3.2.3.

Flow diagrams of the three possibilities described above are shown in Figure 4.4.

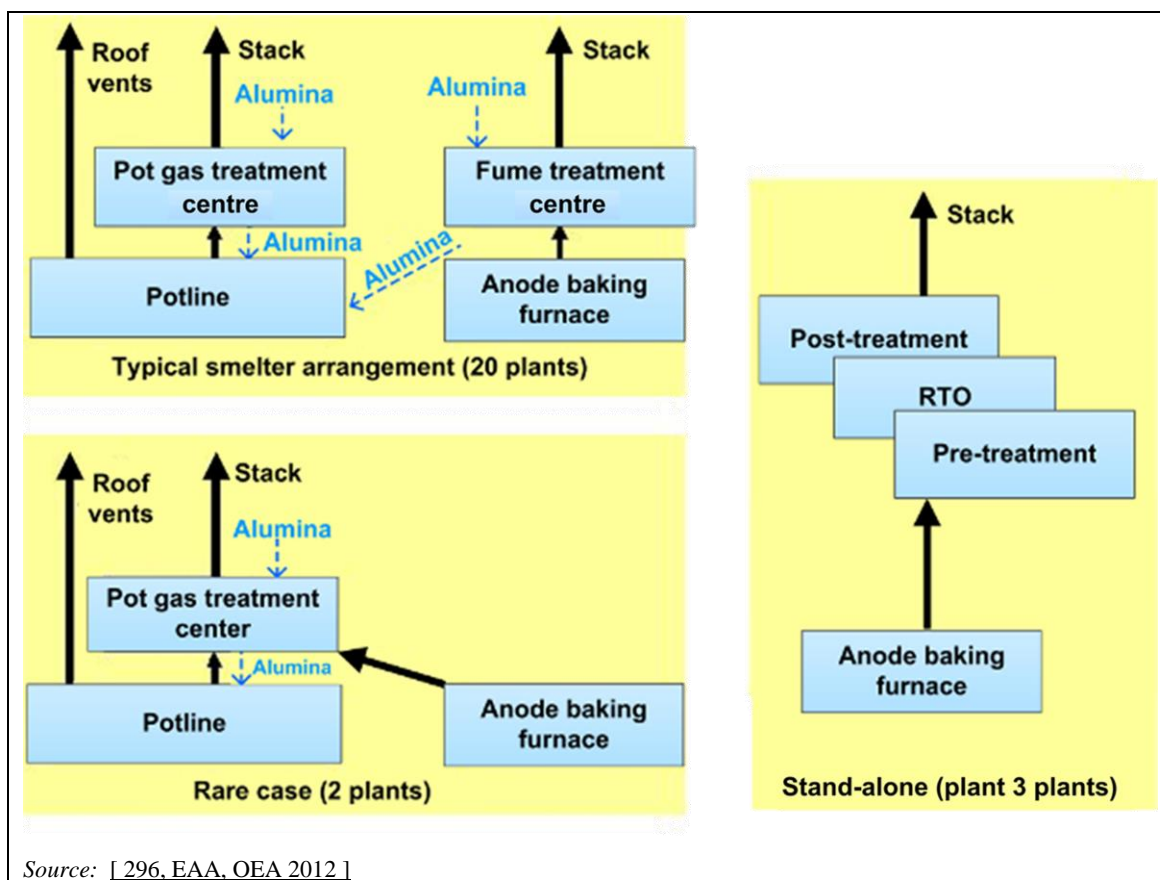

Figure 4.4: Anode baking furnace configurations and approximated number of plants

Once cooled down, the anodes are unloaded from the furnaces and stored. When needed they are taken to the rodding plant, where they are connected to aluminium rods through steel studs. This process allows the rodded anodes (anode assemblies) to be hung onto the anode beams of the electrolytic cells. The anodes are consumed during electrolysis and have to be replaced after about 80 % of the anode is consumed. The remaining part of the anode is called the 'anode butt'. [6, McLellan and Partners Ltd 1993], [28, OSPARCOM 1997]. The butts (20 % of the original anode weight) are reused for anode production after residual electrolyte has been removed. The rods are reconditioned for further use although a small proportion are scrapped if corroded.

The residual electrolyte from the cleaning of the butts is cooled down, then crushed in dedicated bath recycling units and finally recycled to the electrolytic cells.

4.1.3 Primary aluminium

Primary aluminium is produced from aluminium oxide (alumina), [6, McLellan and Partners Ltd 1993], [97, Lijftogt, J.A. et al 1998], [312, VDI 2008] in a two-stage process starting from bauxite.

- Stage one: the production of alumina from bauxite.
- Stage two: the production of primary aluminium from alumina, usually at a different site to the site carrying out stage one production, mainly for logistical reasons and the availability of electricity.

Some aluminas, known as speciality aluminas, do not go through the second stage process if they are mostly intended for metal production.

Aluminium is produced by the electrolytic reduction of aluminium oxide (alumina) dissolved in a molten bath of mainly sodium aluminium fluoride (cryolite) at a temperature of approximately 960 °C. The electrolytic cells (also known as 'pots') each comprise a carbon cathode, insulated by refractory bricks inside a rectangular steel shell, and carbon anodes suspended from an electrically conductive anode beam [312, VDI 2008]. In the pot room, the cells are connected in series to form an electrical reduction line (cell line or potline). A direct current is passed from the carbon anodes through the bath and a layer of metal to the cathode and then, by a set of current conductors known as 'busbars', to the next cell [6, McLellan and Partners Ltd 1993], [97, Lijftogt, J.A. et al 1998].

Alumina is added to the cells to maintain an alumina content of 2–6 % in the molten bath. Additions are computer-controlled in modern plants. Fluoride compounds are added to lower the bath melting point, enabling the cells to be operated at a lower temperature. Aluminium fluoride (AlF_3), the most common additive, also neutralises the sodium oxide present as an impurity in the alumina feed. Aluminium fluoride can be added separately from alumina, and additions can be controlled based on an algorithm of the cell flow pattern [233, COM 2008]. Most cells are now operated with the AlF_3 content of the bath significantly in excess of the stoichiometric cryolite composition. However, fluoride emissions increase as the excess AlF_3 in the bath is increased [6, McLellan and Partners Ltd 1993], [97, Lijftogt, J.A. et al 1998]. When the alumina content of the electrolyte falls below 1–2 %, the so-called anode effect occurs. During an anode effect, instead of decomposing alumina, the cryolite bath is decomposed into metal and fluoride ions that react with the anode carbon and form gaseous PFC emissions.

Liquid aluminium is deposited on the cathode at the bottom of the cell. Molten aluminium is periodically withdrawn from the cells by vacuum siphons into crucibles. During electrolysis, oxygen from the alumina combines with the carbon anode, to form carbon dioxide and carbon monoxide. The carbon anodes are therefore continuously consumed during the process.

Cell systems vary according to the type of anode and the method used to feed alumina, as illustrated in Figure 4.5 [6, McLellan and Partners Ltd 1993], [16, HMIP (UK) 1994] [97, Lijftogt, J.A. et al 1998]. There are two main types of electrolytic cells, Søderberg and prebaked. In a Søderberg cell, there is only one continuous anode, regenerated through the addition of carbon materials at the top while it is consumed at the bottom; in a prebaked cell, a number of anodes need to be changed when they are approximately 80 % consumed.

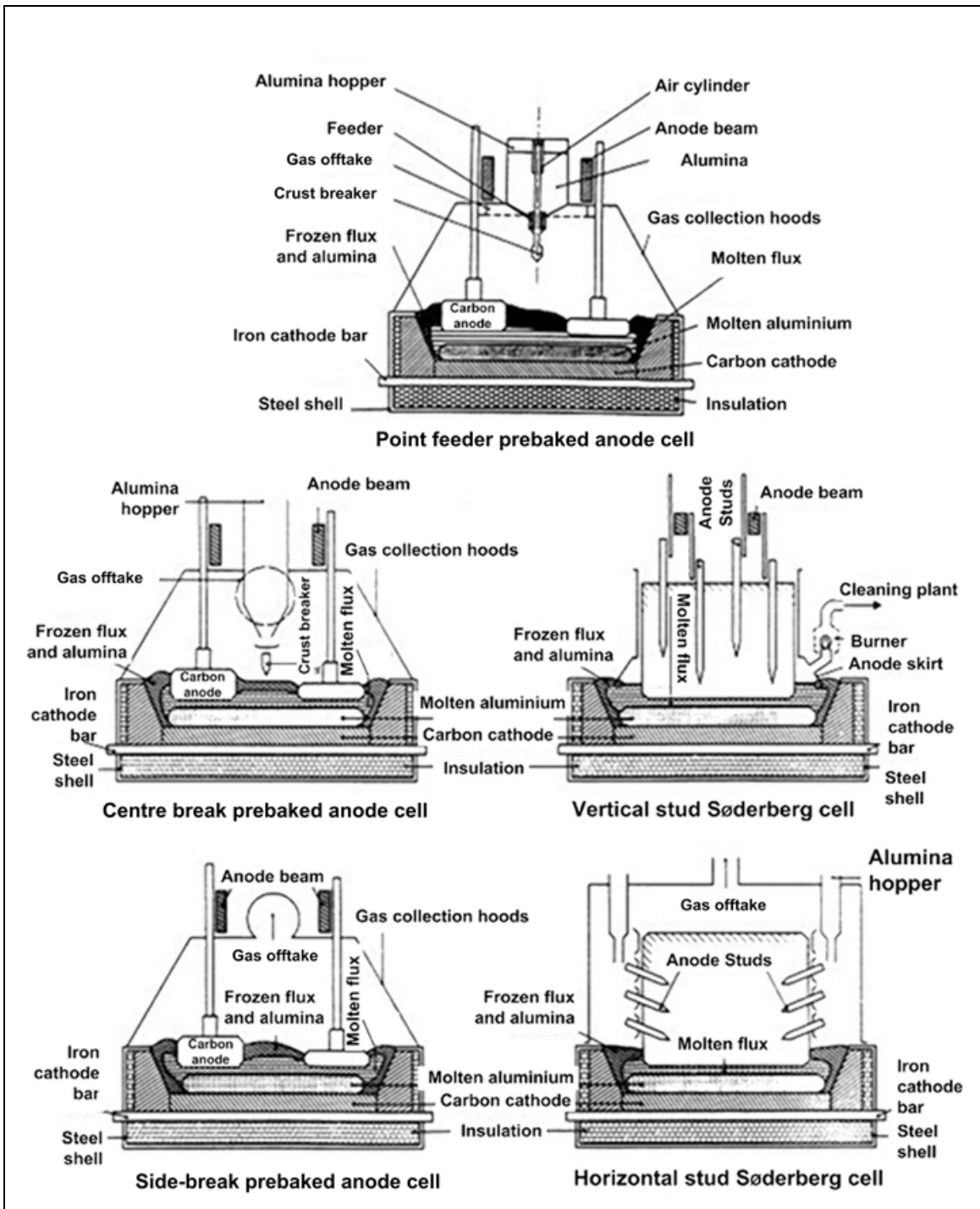

Figure 4.5: Primary aluminium electrolytic cells

a) Søderberg cells

Søderberg technology uses a continuous anode which is made *in situ* from a paste of calcined petroleum coke and coal tar pitch, and is baked by the heat arising from the molten bath and the electric current through the anode. The current is fed into the Søderberg anode through studs that have to be withdrawn and resited higher in the anode as the anode is consumed. As this happens, more paste descends through the anode shell, thus providing a process that does not require the anodes to be changed. Alumina is added periodically to Søderberg cells through holes made by breaking the crust of alumina and frozen electrolyte which covers the molten bath. Automatic point feeding systems are used in upgraded plants, eliminating the need for regular breaking of the crust. A gas skirt is attached to the lower part of the anode casing for gas

collection. Fumes are collected and combusted in burners to reduce the emission of tars and PAH. Pot room ventilation gases may also be collected and treated.

Modernised Söderberg technology consists of equipping the cells with point feeders, improved burners and dry paste. Point feeding the alumina avoids the need for the regular crust-breaking that was necessary in the former technology and subsequently reduces the fluoride and dust emissions associated with these operations. The use of dry paste with a lower pitch content, together with a reduction in the temperature at the anode top, achieved by an increase of the anode height, reduces PAH emissions from the anode top. PAH emissions can be absorbed by the dry paste in the higher anode casing or, when necessary (i.e. with high current density and high anode temperature), collected by anode covers [365, Karuppanan et al. 2002].

b) Prebaked cells

Prebake technology uses multiple anodes, which are manufactured from a mixture of calcined petroleum coke, clean and recycled anode butts and coal tar pitch. Anodes are formed into blocks and baked in a separate anode plant. The anode production plant is often integrated into the primary aluminium plant.

The anodes are suspended in the cells by hanger rods attached to anode beams, which also serve as the electrical conductor. The anodes are gradually lowered as they are consumed and are replaced before the rods are attacked by the molten bath. The remnants of the anodes, which are known as anode butts, are cleaned of bath material and recycled through the anode plant.

Prebaked cells normally have 12 to 40 individual anodes, which are changed at regular intervals. In a large pot room, anode changing is a frequent occurrence and involves the removal of the cell cover shields, known as 'hoods'. This can result in an increase in diffuse emissions if several hoods are removed at the same time. However, there is usually little leakage from the cell being maintained (depending on the rating of the extraction system), and the overall extraction rate from other cells is not reduced. In some plants, an automatic system to increase the rate of air extraction is used for periods when hoods are open.

Prebaked cells can be one of three types depending on how alumina is added.

- **Side-worked prebaked anode cells (SWPB)**, where alumina is fed into the cells after the crust is broken around the circumference between the pot-shell and the anodic equipment. Gas collection hoods covering the entire length of the cells have to be opened during this operation. In some cases, gas collection funnels in the centre channel or between anodes, known as 'mini-hoods', are used instead.
- **Centre-worked prebaked anode cells (CWPB)**, where alumina is fed in after the crust is broken along the centre line
- **Point feed prebaked anode cells (PFPB)**, where alumina is fed in after the crust is broken at selected points on the centre line of the cell.

Both CWPB and PFPB can be carried out without opening the gas collection hoods. PFPB are the most commonly used and allow better control of the process. Indeed, there are no longer any CWPB or SWPB plants in operation in Europe (2013).

An overview of aluminium smelting technologies is given in Table 4.2.

Table 4.2: Aluminium smelting categories

Cell technology	Cell type	Anode configuration	Alumina feed configuration	Acronym	Breakdown in Europe
Prebaked cell	Centre-worked	Vertical	Bar broken centre feed	CWPB (*)	None
		Vertical	Point centre feed	PFPB	90 %
	Side-worked	Vertical	Manual side feed	SWPB (*)	None
Söderberg cell	Vertical stud	Vertical	Manual side feed	SWVSS (*)	None
			Point feed	PFVSS	10 %
	Horizontal stud	Horizontal	Manual side feed	HSS (*)	None
			Bar broken feed		
		Point feed			
(*) No longer in operation in Europe. Source: [366, International Aluminium Institute 2013]					

The gas collection system extracts the process gases to an abatement system that uses dry alumina scrubbers to remove and reclaim HF and fluorides. The scrubber also removes residual tars in the case of a Söderberg installation, but does not remove sulphur dioxide. The fluorinated alumina leaving the scrubbers is separated from the gas flow through filters and is usually fed directly back to the cells. As hooding and gas treatment efficiencies are high in modern plants, pot room ventilation gases are most commonly released through roof vents. The collection and treatment in a wet scrubber of pot room ventilation gases may be done if the pot room concentration of pollutants is high [312, VDI 2008].

The cathode is not consumed in the process but it does deteriorate over time. Carbon blocks absorb electrolyte and after four to eight years have to be replaced due to erosion, swelling and cracking, which can result in the penetration of molten electrolyte and aluminium to the cathode conductor bar and steel shell. Small amounts of cyanides are formed through a reaction between nitrogen and carbon. The cathode residue is known as spent pot lining and several disposal and recycling routes are used for this material [41, Ausmelt Ltd. 1996], [97, Lijftogt, J.A. et al 1998] and these are described in Section 4.2.3.4.

Molten aluminium is periodically withdrawn from the cells by vacuum siphon into crucibles. The crucibles with the siphoned aluminium from the reduction cells are transported to the casting plant and the aluminium is emptied into heated holding furnaces.

4.1.3.1 Melting and molten metal treatment

Liquid metal from electrolysis is kept in induction or reverberatory holding furnaces. Reverberatory holding furnaces may be equipped with regenerative burners in order to preheat combustion air and so save energy. Alloying additions are made in these furnaces by the addition of the required metal (Si, Mg, Pb, Sn, Zn, Cu, Zr, Sr) or master alloy of the metal with aluminium (Ti, Cr, Fe, Mn, Ni). Other additions are also made to refine the grain of the metal; titanium or titanium boride are the most common. Homogenisation can be achieved by moving the melt with the help of stirrers or stirring machines. Electromagnetic or mechanical liquid metal pumps may also be used to achieve melt circulation and improve homogenisation of the alloyed metal in reverberatory furnaces.

The temperature for casting is controlled in the holding furnaces.

The metal is treated to remove metallic impurities such as sodium, magnesium and calcium, and non-metallic particles and hydrogen. This treatment is performed in two stages: in the first

stage, fluxing salts consisting of aluminium fluoride, magnesium chloride or potassium chloride are added to the furnace to remove metallic impurities and, in the second stage, gas is injected into the molten metal usually in an in-line reactor. The treatment gas used varies depending on the impurities; argon or nitrogen is used to remove hydrogen while mixtures of chlorine and argon or nitrogen are used to remove metallic impurities of the alkali and alkaline earth group. The metal is then filtered before casting.

Primary aluminium sites melt commercial metal and scrap. The scrap melted in these sites includes internal company scrap from extrusion and rolling without substances such as paint or plastic (including customer returns without paint or plastic and scrap from sites belonging to the same company), and scrap bought on the market that does not contain substances such as paint, plastic or oil. This scrap can be melted in two ways: either in the furnace before adding liquid metal from electrolysis or by adding it to a furnace that already contains liquid metal.

Skimmings/dross are formed by the reaction products of the purging treatment and the oxidation of molten aluminium on the surface of the melt. This dross is skimmed off. Sealed containers or dross presses, nitrogen or argon blanketing or compaction can be used to minimise further oxidation of the skimmings/dross [103, COM 1998]. Throughout this chapter, the terms skimmings and dross are used interchangeably. Both are either processed locally to recover aluminium or recycled by the secondary aluminium industry. The residue left after recovering the aluminium from the dross or skimmings from primary casthouses is normally landfilled.

4.1.3.2 Casting

Slabs, T-bars or billets are cast in vertical direct-chill casting machines that use water-cooled metal moulds and a holding table at the bottom of the moulds. The table is lowered as the ingot is formed. Billets and slabs with smaller cross sections can also be produced by horizontal direct-chill casting. Other casting methods include the use of metal moulds (static or continuously moving) and the continuous casting of thin sheets as well as wire rod, [6, McLellan and Partners Ltd 1993]. Additional small quantities of skimmings/dross are also produced at this stage and are removed from the surface of the molten metal.

4.1.4 Secondary aluminium

Secondary aluminium is produced from the scrap melting. Two main features of secondary aluminium production are the diversity of raw materials encountered and correspondingly the variety of furnaces used [113, ALFED 1998]. Scrap is graded using a number of criteria such as source, impurities and metal yield under the EU standard EN 13920. Other categorisations also exist, such as Council Regulation (EU) No 333/2011, and national or industry specifications, which have their own criteria for grading. The type of raw material and its pretreatment are used to decide the most appropriate type of furnace, flux and abatement systems to be used for a particular type of scrap, based on its size, oxide content and degree of contamination, among other factors [142, Boin, U. et al. 1998], [312, VDI 2008].

4.1.4.1 Production processes

The metals are first sorted into cast alloys and wrought alloys. The majority of wrought alloy scrap is remelted in chamber or hearth furnaces. The cast alloys are mostly remelted in (sometimes tiltable) rotary drum furnaces. The choice of suitable treatment processes, furnace type and other necessary process steps (holding, alloying, melt treatment) depends primarily on the type and composition of the raw materials employed and on the product quality required. Direct comparisons between the performances of different smelters, for instance, are not helpful, as the processes are optimised for their specific application. However, industrial experience has yielded typical fields of application that permit the practical selection of smelters

for the specific application. Typical process steps include pretreatment, charging, melting, skimming, holding, treating the molten metal, and casting. As a result, the process parameters of relevance to the plant's emissions (e.g. waste gas temperature, raw gas contamination) are subject to strong fluctuations. The comparability of data is also hampered by different measuring locations.

Salt slags arise when salt mixtures are used to cover the molten metal to prevent oxidation, increase yield and increase thermal efficiency. These slags are generally produced in rotary furnaces and have an adverse environmental impact if they are deposited on land. The quantity of salt slag produced varies considerably and is dependent on the type of material, the furnace and the degree of contamination of the aluminium, etc. There are options available for salt-free melting in some furnaces using many types of feed materials and there are options for recycling all of the components of salt slag] [312, VDI 2008].

The choice of the process technique used will vary from plant to plant. The number of factors that influence the choice of process means that there is the potential for many viable strategies which can address similar circumstances. The generic secondary aluminium production process is shown in Figure 4.6.

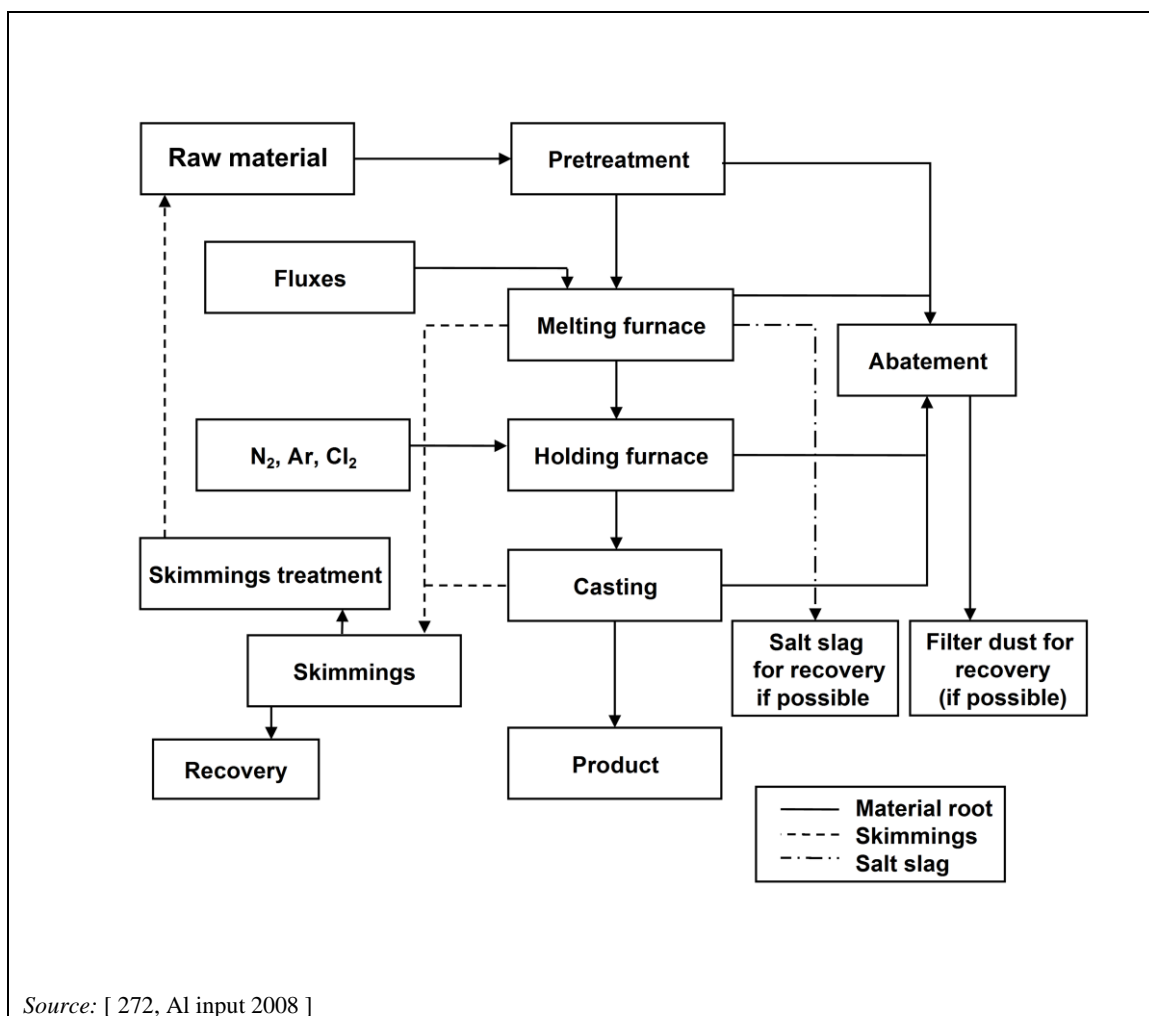

Figure 4.6: Generic secondary aluminium production process

4.1.4.1.1 Pretreatment

Typical sources of aluminium scrap are process scrap, used beverage cans (UBCs), foils, extrusions, commercial scraps, turnings, and old rolled or cast metal. In addition, aluminium is also recovered from skimmings/dross and salt slags. Various contaminants may be present and

this is taken into account in the choice of pretreatment or in the design of the furnace [75, Nordheim, E. 1998]. Scrap is generally sorted first into alloy types for producing the desired alloy with the minimum amount of reprocessing [113, ALFED 1998] [118, Laheye, R. et al. 1998].

Scraps such as UBCs and turnings are major sources of material feedstock, but may be contaminated. As a consequence, they sometimes need to be decoated or de-oiled prior to melting, to improve their melting rate (and thermal efficiency) and to reduce the potential for emissions [118, Laheye, R. et al. 1998], [119, McLellan 1998]. The melting of cleaned material can save energy and reduce the generation of skimmings/dross.

4.1.4.1.2 Melting process

The ranges of typical furnace, process and emission parameters (raw gas) of various aluminium melting plants are shown in Table 4.28 [312, VDI 2008].

Rotary or reverberatory furnaces (also known as closed well, chamber or hearth furnaces) are used for melting a wide range of secondary raw materials. Rotary furnaces can incorporate a tilting mechanism. The tilting mechanism in some cases allows increases in efficiency for melting raw materials that contain low amounts of aluminium including skimmings/dross, and the amount of flux needed for these materials can also be reduced, [142, Boin, U. et al. 1998], [256, Winter 2007]. Induction furnaces and shaft furnaces (the Meltower) are used to melt cleaner aluminium grades. Reverberatory furnaces often include a side well. A pumping system (mechanical or electromagnetic) is sometimes used to convey molten metal through the side well and a charging well to assist the melting of small particles.

Electromagnetic pumps have no moving parts and rely on an external coil to induce the electromagnetic force; stirring is induced in the charging well and in the furnace. Other pumps, which have heat-resistant internal parts and metal 'spinners' are also used [142, Boin, U. et al. 1998].

The use of a side well reverberatory or chamber furnace with a charging well and pumping system can increase the number of grades of scrap, including foil and small turnings, that can be melted in these furnaces. It can also reduce the loss of metal by oxidation without using large quantities of salt or another cover [118, Laheye, R. et al. 1998] [119, McLellan 1998], [120, McLellan 1998].

Reverberatory furnaces (closed well, chamber or hearth furnaces) may also use a sloping hearth in the metal feed area, where items containing large pieces of iron can be placed. Aluminium is melted off the iron substrate, which remains in the hearth. Contamination of the melt by iron is therefore minimised [75, Nordheim, E. 1998], [113, ALFED 1998].

A range of different fluxes, which are normally mixtures of salts, is used within the secondary aluminium industry to assist in the processing of the metal in a number of ways. An example is the use of fused salt (a mixture of sodium and potassium chlorides and some fluorides) to reduce oxidation, absorb impurities and increase thermal efficiency. Furnace gases contain chlorides and hydrogen chloride produced from the salt. Refractory fluxes and fluorinated fluxes are also used. Salt slag is tapped separately from the metal. There are variations in the quantity of salt flux cover used and this depends on the furnace used and the oxide content of the raw material. Pretreatment of the feed material can reduce the salt usage. It has also been reported that up to 1.1 kg of salt per kg of non-metallic constituents is used for a static rotary furnace, and < 0.5 kg per kg for a tilting rotary furnace [142, Boin, U. et al. 1998], [312, VDI 2008].

4.1.4.1.3 Molten metal treatment and casting process

Metal may be tapped from the melting furnace, where alloy additions are made either directly to a casting system or via a transfer system into a holding furnace (where other alloying additions can be made). The metal is then refined either in the holding furnace or in an in-line reactor, to remove gases and other metals. Magnesium and other impurities can be present in secondary aluminium and may also need to be reduced. To remove magnesium, molten aluminium is treated with chlorine gas mixtures; sodium aluminium fluoride and potassium aluminium fluoride are also used [113, ALFED 1998]. The latter material is a by-product of the production of some master alloys.

Aluminium is easily oxidised and this is a significant factor in the production processes. The melting of aluminium produces an oxide layer known as skimmings/dross. This is skimmed from the metal surface before casting.

Large ingots, billets and slabs are cast in the same way as described for primary aluminium casting in Section 4.1.3.2. Moulds are used to cast a range of smaller ingots (e.g. for supplying the casting industry), which may be produced in a large variety of alloys depending on the final application. Casting alloys may also be tapped into preheated crucibles, and may be used to transport molten aluminium by road in special thermally insulated containers to end-users.

4.1.5 Salt slag

In secondary aluminium production, rotary or tilting rotary furnaces [256, Winter 2007] are used to melt various grades of scraps and also skimmings/dross. Salt flux is usually used to facilitate this process, as it reduces oxidation and promotes the removal of some impurities (e.g. Mg, Ca, Li). The used salt flux tapped from the furnace is called salt slag. At the time of writing (2014), one million tonnes of salt slag are generated and treated in the EU-28 every year.

Proprietary salt flux is a mixture of NaCl, KCl and a minor amount of calcium fluoride (CaF₂). Some other fluoride may also be added, up to 5 %. The salt slag contains large amounts of aluminium oxides and various impurities that the flux has separated from the molten metal. A total of 4–10 % of the total weight of salt slag is metallic aluminium (see Table 4.3).

Table 4.3: Typical composition of the salt slag

Contents	Typical value (%)	Range (%)
Al, metallic	6	4–10
Water-soluble salts	37	20–55
Metal oxides, unrecovered metal and insoluble salts	55	35–75

Several installations exist where salt slag can be recovered using a washing and crystallisation process, which separates the components in salt slag based on their own different physical characteristics. There is sufficient capacity to recover salt slag from the secondary aluminium industry operating in the EU-28. The process produces recycled aluminium granules and salt. The metal oxide fraction (mainly oxides of aluminium, calcium and magnesium) can be further processed and washed to produce fine aluminium oxide, which can be sold to the cement industry [359, Tsakiridis 2012].

4.1.5.1 Salt slag recovery

Salt slag can be completely recovered to produce marketable products without producing any residues except for some activated carbon (if used at all). Two types of recovery processes exist: the full recycling process and the partial recycling process. In the full recycling process, all the components in salt slag are completely recovered and there is no generation of waste water. There are three partial recycling processes in operation.

- One is part of a fertiliser production plant that only recovers KCl and aluminium granules, while other components (sodium chloride and oxides) are used for recultivation of potash tailings piles. The process principally uses the same main steps as the full recycling process (mechanical pretreatment, leaching with waste gas treatment, solid-liquid separation, and crystallisation). In this case, only the KCl content (10–20 % in typical salt slag) is recycled as salt product. After further processing in an internal salt-refining step of the potash plant, it is sold to the fertiliser industry. The water-soluble NaCl content (20–40 % in typical salt slag) remains in the leaching [360, Germany 2013]. Waste water can be generated by gas cleaning.
- In another partial recycling process, besides the recovery of salt, all process steps are similar to full recycling [233, COM 2008]. The process water and waste water from the gas-cleaning treatment filter is directed to an old mine system that ends in an outlet to the sea. In this mine system, the remaining particles are sedimented to the ground. The calculated retention time for the process water going to the mine before entering the sea outlet is two years.
- In the third one, the aluminium and the other metallic products are recovered through electromagnetic and mechanical processing and the residues are disposed of [361, Spain 2013].

The full recycling process is a combination of different physico-chemical process steps for the recovery of aluminium salt slag. In each process step, the three main salt slag components used to separate the material fractions are:

- metallic aluminium (4–10 % in typical salt slag), which is insoluble in water; during crushing, the ductile nature of aluminium means that small particles are pressed into flakes with a larger surface area which can be removed by sieving;
- oxidic components (35–75 % dry solids in typical salt slags), which are insoluble in water and are brittle; crushing tends to break them into finer particles;
- alkaline chlorides (20–55 % in typical salt slag), which are highly soluble in water and are also brittle.

It is also technically possible to recover dust produced during the pretreatment processes of the aluminium slags and scrap, as well as the dust from the filtration of the furnaces, and this is already being carried out in some plants. This shows that all the solid wastes generated by the secondary aluminium industry can be recycled. Washing water is normally returned to the dissolvers to make up for the water evaporated in the process. The typical contents of the insoluble, non-metallic portion of salt slag are shown in Table 4.4.

Table 4.4: Typical contents of the insoluble non-metallic portion of salt slag

Component	wt-% ⁽¹⁾	Component	wt-% ⁽¹⁾
Al ₂ O ₃	60–75	TiO ₂	0.5–1.5
MgO	3–14	MnO	< 0.3
SiO ₂	3–12	Na ₂ O	< 1.0
CaO	1.5–5	K ₂ O	< 1.2
Fe ₂ O ₃	1.5–3.0	Cl ⁻	< 0.8
Bound water	7–16		
⁽¹⁾ Refers to dry substances. Source: [272, Al input 2008]			

4.2 Current emission and consumption levels

4.2.1 Alumina

The material and energy inputs to the process are significant. Approximately two tonnes of bauxite are required to produce one tonne of alumina, which in turn produces about 0.53 tonnes of aluminium. The carbon anodes are consumed and approximately 0.4–0.45 tonnes of carbon are used per tonne of aluminium produced. The energy costs are also high and can account for approximately 30 % of the production costs. Input ranges for alumina production are shown in Table 4.5.

Table 4.5: Input ranges for alumina production

Parameter	Typical range (kg/t of alumina)
Bauxite	2065–2275
NaOH (50 %)	30–70
CaO	30–80
Water	1000–5000
Energy (GJ/t)	7.6–11.7
<i>Source: [272, Al input 2008]</i>	

The production of alumina requires energy for digestion and calcination. The energy used is influenced mainly by the origin and chemical composition of the bauxite, the type of digesters used and the type of calciners used. The quantities of NaOH and CaO used are also linked to the composition of the bauxite.

The reduction of energy demand is mainly related to using tube digesters, which are able to operate at higher temperatures using a fused salt heat transfer medium and which enable plants to operate with an energy consumption of less than 10 GJ per tonne. However, tube digesters are virtually impossible for existing plants for both cost and space reasons.

4.2.1.1 Emissions to air from alumina production

The calcining of bauxite generates dust, SO₂, CO₂ and NO_x emissions. The abatement technique applied is a bag filter or ESP.

4.2.1.2 Red mud

One major output of the Bayer process is 'red mud', which is the remaining solid material after the extraction of the bauxite and which does not dissolve in the liquor. The specific amount and composition of the red mud depends strongly on the bauxite quality. The quantity produced varies between 600 kg per tonne of Al₂O₃ and 1500 kg per tonne of Al₂O₃ and, therefore, this represents a major disposal requirement. Current practice is to deposit red mud on or near the site in specially designed, sealed ponds. Excess water from the ponds is normally returned to the process.

Some refineries use high-pressure filtration as a last step for red mud treatment. The output from this operation is a solid bauxite residue, which can be easily and safely transported over long distances and which can be used in various applications, such as in the cement industry for the production of clinker, in the ceramic industry as an alternative raw material, or in road construction. [247, France 2008]. The production of saleable products from this process is reported in Section 4.4.

At one site, the red mud is resuspended to 20–25 % solids using fresh seawater and free water from the tailings pond and is then pumped to the tailings pond. The neutralisation of the mud is performed by the flue-gas desulphurisation in the wet scrubbing operation and also takes place due to the magnesium chloride content of the fresh seawater which is added to the system [295, Gaver C. Jr 2013]

Despite repeated washes, the solution entrained within the red mud still contains small amounts of caustic (sodium hydroxide), which causes the elevated pH, and alumina. Most of the caustic converts to sodium carbonate and sodium bicarbonate on the tailings stack.

4.2.1.3 Emissions to water

The production of alumina from bauxite is carried out in a closed system to eliminate emissions to water. Water that is contained in the red mud or that is used to transport the red mud to the disposal site is highly alkaline and is pumped back to the plant and reused. [75, Nordheim, E. 1998].

4.2.2 Anodes for aluminium production

The production of carbon anodes for aluminium production is primarily a source of dust and emissions to air. When abatement techniques are applied to reduce emissions, cross-media effects may occur. Sections 4.2.2.2 to 4.2.2.4 below describe the most relevant environmental issues for the production of carbon anodes for primary aluminium production.

4.2.2.1 Mass stream overview and input/output data

The energy used in anode production is 2000–2400 MJ per tonne of anode, which is accounted for by the fuel used. Packing coke is consumed at a rate of ~ 12–18 kg per tonne of anode. [116, VDI 1998]

4.2.2.2 Emissions to air from anode production

There are potential emissions to air of hydrocarbons and PAH, sulphur dioxide, dust, and fluorides (only if anode butts are used in the anode production). The formation of SO₂ is influenced by the fuel and raw materials used, whereas the formation of NO_x is determined by the combustion temperature.

Emissions can escape the process either as stack emissions or as diffuse emissions, depending on the age of the plant and the technology used. Stack emissions are normally monitored continuously or periodically and reported by on-site staff or off-site consultants to the competent authorities. Provisions are made for fume treatment plants to be bypassed in the event of scrubber failure or during maintenance periods.

When a new anode plant is associated with a primary aluminium smelter, the process gases from the plant can be combined with the electrolytic cell gases for scrubbing processes using alumina. In an existing plant, the gases are treated separately in a dry scrubber using alumina. A bag filter is used and the alumina collected is used in the electrolytic cells. Dust from handling and mechanical processes such as grinding, mixing and forming is collected in fabric filters [75, Nordheim, E. 1998], [88, Nordheim, E. 1998], [272, Al input 2008]

When pitch vapours are present in the gas, dry coke scrubbers, CTOs or RTOs can be used.

The basic anode baking process and associated fume treatment for aluminium smelters producing primary aluminium by electrolysis are shown in Figure 4.7.

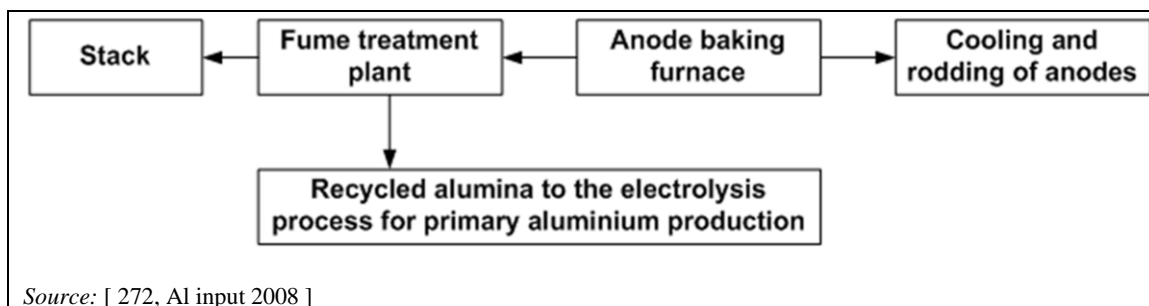

Figure 4.7: Anode baking process and fume treatment

Table 4.6 shows the untreated mass emissions from anode production when it is associated with a primary aluminium smelter.

Table 4.6: Raw gas from anode production in a plant associated with a primary aluminium smelter

Component	Raw gas content (kg/t of aluminium ⁽¹⁾)	Remarks
Fluorides (gaseous)	0.05–0.6	Emissions of solid fluoride are usually negligible
PAH	0.15–0.5	Estimated value based on a weight loss of about 5 % during baking
Hydrocarbons	25–40	
Dust	5–10	Estimated value

⁽¹⁾ For a process associated with primary aluminium production, with raw gas masses of various pollutants, and where captured emissions are treated in the same alumina scrubber/fabric filter that is used for the electrolysis gases.
Source: [272, Al input 2008]

Emissions for the various abatement systems employed are shown in Table 4.7 and Table 4.8.

Table 4.7: Emission concentration ranges for anode production processes

Source	Abatement type	Pollutant	Concentration range (mg/Nm ³)
Material storage and handling of coke	Cyclone	Dust	20–60
	Fabric filter	Dust	1–20
Material storage and handling of pitch	Pitch fume dry scrubber or CTO or RTO (if dust is not present) or Cooling and condenser	Hydrocarbons	< 25
Grinding, mixing and forming	Fabric filter	Dust	< 5
Baking	Open furnaces: Dry scrubbing with alumina and dust removal in a fabric filter	Dust	< 10
		HF	< 0.5
		Total F	< 0.8
		PAH (OSPAR 11)	0.2–0.5
	Closed furnaces: ESP and scrubber Regenerative thermal oxidiser (RTO) with HF adsorption	BaP	< 0.5 µg/Nm ³
		Dust	< 5
		Hydrocarbons	< 2 (total) ⁽¹⁾
		PAH	0.05–2.5 ⁽²⁾
		HF	< 5
		SO ₂	< 250
NO _x	< 150		
⁽¹⁾ Condensable and volatile hydrocarbons. Can also be reported as TVOC, measured by FID with a limit of 50 mg/m ³ . ⁽²⁾ PAH sampling is carried out in accordance with BS ISO 11338 and the subsequent analysis reports 16 PAH. <i>Source:</i> [272, Al input 2008], [345, UBA (D) 2009]			

Table 4.8: Emission specific load ranges from the production of prebaked anodes

Component	Typical range
Fluoride (kg/t)	0.01–0.1
Dust (kg/t)	0.01–1.0
BaP (g/t)	0.0015–3.0
SO ₂ (kg/t)	0.1–6.0
NO _x (kg/t)	0.1–0.4
<i>Source:</i> [272, Al input 2008]	

4.2.2.2.1 VOCs, hydrocarbons and PAH

Paste for anodes is produced from petroleum coke, cleaned anode butts and coal tar pitch. Emissions of hydrocarbons as tars can occur during delivery, transfer, mixing and baking. About 40 % of the coal tar pitch is volatilised during baking and more than 95 % of the volatile hydrocarbons are burnt off at the high temperature in the furnace. Baking therefore results in the residual emission of hydrocarbons and PAH due to their presence in the coal tar pitch. PAH are potentially hazardous to the environment, as well as inside industrial plants. Emissions are therefore controlled by the various types of abatement equipment described. The preferred reporting convention for PAH is the EPA 16, as this is compatible with the PRTR reporting requirements. However, within the European aluminium industry, there is an increasing consensus for using BaP as a tracer for all other PAH, as this is compatible with the European legislation on ambient air quality.

4.2.2.2.2 Dust

During production, dust emissions occur during all process stages (storage, transfer, crushing, mixing and baking). The emissions are mainly caused by dust generated during crushing and from the carbonisation gases. The mechanical handling and treatment stages are usually enclosed and vented [116, VDI 1998]. The source of dust and its characteristics influence the abatement method used to remove it; carbon dust can be very fine and abrasive.

4.2.2.2.3 Combustion gases

Gases produced from the combustion of gas or fuel oil will be emitted from the process. These include potential emissions of carbon oxides and the oxides of sulphur and nitrogen. Optimisation of the combustion conditions and the use of low-NO_x burners are commonly practised, and the choice of fuel depends on the site conditions.

4.2.2.2.4 Sulphur dioxide

The raw materials from which the anodes are made contain sulphur, and the fuel used for heating can also contain sulphur. This results in a small emission of sulphur dioxide during baking [6, McLellan and Partners Ltd 1993]. The emissions of SO₂ are in the range of 0.5 kg (gas) to 2 kg (fuel oil) per tonne of aluminium depending on the fuel used. This is far less than the emissions of sulphur dioxide produced during electrolysis as the anode is consumed.

4.2.2.2.5 Fluorides (anode production if anode butts are used)

Fluorides are emitted when anode butts from the aluminium electrolytic process are used in the blend for anode production. The anode butts are slightly contaminated with fluorides from the electrolyte. Emissions of particulate fluoride from anode baking plants are negligible. The HF emissions from the anode baking (if scrubbed) equal about 1 % of the emissions generated by aluminium electrolysis [97, Lijftogt, J.A. et al 1998].

4.2.2.2.6 PCDD/F

The latest information (up to 2009) for test results on emission sources and abatement units in this sector indicate that PCDD/F are not relevant for conventional carbon manufacturing processes. This will need to be examined if chlorine compounds or additives are used.

4.2.2.3 Emissions to water

The production of carbon anodes is an inherently dry process, although small quantities of water may be added to increase the homogeneous nature of the mix. The discharge of process waste water is usually limited to cooling water, although most processes use a sealed cooling system. Rainwater run-off from surfaces and roofs may contain carbon dust and associated material. The open storage of raw materials and deposited solid emissions are a source of potential contamination. Typical values for processes associated with primary aluminium production for this contamination are < 0.03 kg/tonne for suspended solids and < 0.02 kg/tonne for dissolved fluoride [97, Lijftogt, J.A. et al 1998]. Best practice is to use vacuum systems for material transfer and closed silos for storage, so that contamination of run-off water is reduced.

Indirect water systems can also be used to cool the flue-gases, to make them suitable for abatement with regular techniques (i.e. fabric filters, electrostatic precipitators). [97, Lijftogt, J.A. et al 1998].

4.2.2.4 Process residues

Refractory bricks from the baking furnaces can be reused in other applications after cleaning or can be disposed of as waste. The typical furnace lining life for prebaked anodes is about 100 cycles and this represents approximately 10 kg of bricks per tonne of anode produced.

Other residues include the material removed during the forming process together with tar or pitch fractions. Depending on the material, they are usually suitable for recycling within the process as raw materials or in other processes as a fuel or carburetant.

4.2.3 Primary aluminium

4.2.3.1 Mass stream overview and input/output data

Inputs and outputs from primary aluminium production are shown in Figure 4.8.

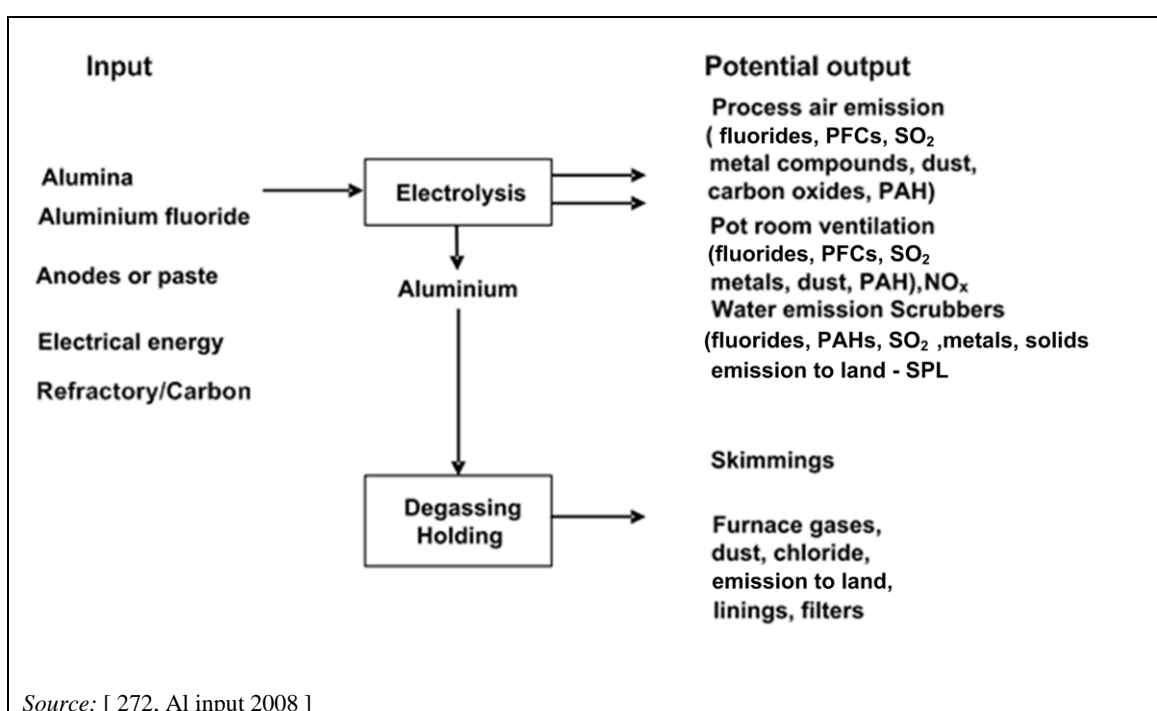

Figure 4.8: Input and output from primary aluminium production

The aluminium electrolysis stage has a high energy use, ranging from 53 GJ per tonne for the best operated PFPB (including anode production) to 61 GJ per tonne for some traditional Söderberg cells. The energy costs are also high and can account for up to 50 % of production costs. Energy requirements are also influenced by cell geometry, busbar configuration and other factors influencing the magnetic upheaval of the liquid metal pad. Input ranges for electrolysis, energy consumption and raw materials used are shown in Table 4.9.

Table 4.9: Input ranges for electrolysis

Parameter	Prebake	Söderberg
Alumina (kg/t Al)	1910–1960	
Anodes net (kg/t Al)	410–450	NA
Anode paste (kg/t Al) ⁽¹⁾	NA	470–530
Al F ₃ (kg/t Al)	13–30	18–25
Cathode life (years)	5–8	4–6
Amperage (kA)	90–360	
Power for alumina production (GJ/t Al)	< 10	< 10
Specific energy consumption for electrolysis (kWh/kg Al)	13.2–15.0	14.5–17.0 ⁽²⁾
Total electrical power (kWh/kg Al) ⁽³⁾	13.6–15.7	15.1–17.5
⁽¹⁾ Expressed as total Söderberg paste. In the case of Söderberg cells, the figures represent the gross carbon consumption as the baking losses happen during the electrolysis. ⁽²⁾ In the Söderberg process, these figures account for all energy consumption, while in the Prebake process there is additional consumption in the baking furnace. ⁽³⁾ Including rectifier loss, pollution control and auxiliary consumption. NB: Energy data are produced based on the conventions used by Industry. NA = Not applicable. Source: [272, Al input 2008].		

The production of aluminium from recycled metal uses only 5 % of the energy of primary production [28, OSPARCOM 1997]. The consumption data for the casthouse are shown in Table 4.10.

Table 4.10: Casthouse consumption data

Parameter	Range
Skimmings/dross produced (kg/t Al)	10–50
Fluxes (kg/t Al)	0–1.5
Gases (kg/t Al)	0–0.04
Swarf, etc. (kg/t Al)	0–3
Water (kg/t Al)	200–10 000
Homogenisation energy (MJ/t Al)	500–1200
Casthouse energy (MJ/t Al)	300–2500 ⁽¹⁾
⁽¹⁾ Excluding remelting of cold metal. Source: [272, Al input 2008].	

It must be noted that the airflow going through the roof vents can be much higher (typically 5–15 times higher) than the gas flow being sucked from the pots and directed to the gas treatment centres.

4.2.3.2 Emissions to air

Emissions from the production of aluminium by electrolysis are mainly emissions to air. There are three distinct sources of emissions to air from this process:

- process gases from electrolytic cells;
- pot room ventilation;

- degassing and casting.

The potential emissions from the electrolysis stage are:

- carbon dioxide (CO₂) and carbon monoxide (CO) (accounted for as CO₂ in the further provided emission figures), linked to anode consumption;
- polyfluorocarbons (PFCs) in connection with anode effects;
- dust, mainly linked to alumina and fluorinated product handling, from around the pots or the handling systems;
- fluorides, both gaseous and as particulates, at the surface of the bath;
- sulphur dioxide (SO₂) and other sulphur compounds, resulting mainly from anode consumption, and due to the sulphur contained in coke and pitch;
- tars and polycyclic aromatic hydrocarbons (PAH) in the case of Söderberg electrodes;
- metal compounds;
- oxides of nitrogen (NO_x).

The emissions from the electrolytic cells and via the pot room ventilation are related to each other by the efficiency with which the flue-gases from the cells are captured [28, OSPARCOM 1997], [97, Lijftogt, J.A. et al 1998], [226, Nordic Report 2008], [357, VDI 1998]. The specific gas emission rate from the electrolytic cells due to the cell extraction system is reported to be 80 000–120 000 Nm³ per tonne of aluminium [348, Solios 2010].

The potential emissions from the degassing and casting stages are:

- dust;
- organics, chlorides and fluorides, associated with the use of fluxing agents;
- SO₂, depending on the fuel used;
- NO_x, depending on the type of burner.

4.2.3.2.1 Capture of the gases

The capture of the gases is affected by the technology and design of the pots used. Most of the gases released from the pots occur during crust-breaking and anode changes. Therefore, the way the crust is broken and the alumina is fed into the pot makes a significant difference to the amount of gases emitted from the pot.

Plants operating point feeding systems break the pots through specific 'points' where the crust-breaker and feeders are located. This type of plant allows a much higher capture efficiency than conventional Söderberg pots or side-worked prebaked pots, where alumina is not fed continuously and is fed into the cells after the crust is broken around the circumference and where collection hoods over the length of the cells have to be opened.

Today, all European plants, using either Prebake or Söderberg technology, apply point feeding systems.

a) Prebaked cells

The cells are totally enclosed and have a fume extraction system. A typical hooding efficiency range for point feed prebaked cells (PFPB) is 95–98.5 %, and up to > 99 % when a boosted suction system (BSS) is used, depending on the design of the extraction system, the effectiveness of the cell covers and the arrangement of the extraction and filter systems. [357, VDI 1998]

b) Söderberg cells

Several improvements have been made to the conventional Söderberg electrode system, with the objective being to reduce anode effects and emissions from the pots to a level comparable with the total emission from prebaked pots, including anode baking. The main features are:

- automatic and closed alumina point feeding and control of electrolysis;
- improved coverage of the bath crust;
- the use of dry paste with a lower pitch content;
- improved burner for incineration of PAH and other hydrocarbons in the pot exhaust gas;
- for pots with a high current density, complete hood coverage of the anode top, which is connected to a separate gas exhaust and dry alumina scrubber;
- for pots with a lower current density, increased anode height to create a solid barrier at the top of the anode that serves as a filter for PAH emissions.

These improvements result in a significant increase in the capture of gases [28, OSPARCOM 1997], [226, Nordic Report 2008]. The range encountered in improved Söderberg plants equates to a capture efficiency of up to 95 % based on the HF concentration, depending on the degree of modification. It also depends on the extent of evaporation from the bath of HF which cannot be captured (usually lower in Söderberg cells due to the bath chemistry) [75, Nordheim, E. (EEA) 1998], [233, COM 2008]. The HF concentration in the pot room atmosphere can be monitored continuously using an open path continuous monitoring system.

The pot room emissions from Söderberg cells are therefore significant and these processes can include wet scrubbing systems, such as wet scrubbers with seawater to remove fluoride and PAH from pot room ventilation air. PFPB are inherently more efficient at capturing process gases but rely on good design, maintenance and operating procedures.

4.2.3.2.2 Fluorides

Airborne gaseous and solid fluorides are emitted from the pots during electrolysis; 50–80 % of the fluoride is gaseous HF, with the remainder being solid fluorides (mainly aluminium fluoride and cryolite). HF is formed by the reaction of aluminium fluoride and cryolite with hydrogen introduced to the pot as fixed water in aluminium oxide, as residual hydrogen in anodes, and as moisture in the air. As modern pots are often operated with a high stoichiometric excess of AlF_3 (10–13 %), fluoride generation has increased over the years and fume capture has become more important [97, Lijftogt, J.A. et al 1998].

The total fluoride emissions from the pots vary between 20 kg and 50 kg per tonne of aluminium. With a capture efficiency of > 98 % and a cleaning efficiency of 99.8–99.9 % in dry scrubbing installations, stack emissions can be 0.06–0.3 kg of total fluoride per tonne of aluminium. Alumina is used as the scrubbing medium. The alumina is normally collected, with the process dust, in a fabric filter, and is then used directly in the electrolytic cells. The fluorides collected in the alumina form aluminium fluoride and sodium fluoride (after reaction with any sodium oxide present in the alumina) and contribute to the amount of cryolite in the cell bath. Most plants that operate alumina scrubbers produce excess cryolite from the reaction of fluorides with the sodium content of the alumina and this is sold as excess bath. This is not produced all of the time, as its formation depends on the sodium content in the alumina, which can change over time or when suppliers are changed [348, Solios 2010].

Uncaptured emissions are discharged to the pot room ambient air and emitted through the ventilation system. When no roof ventilation wet scrubber or boosted suction system is applied, total emissions (stack and roof) of gaseous fluorides can be 0.4–0.8 kg per tonne of aluminium, giving a total fluoride emission (including particulate fluorides, stack and roof) in the range of 0.46–1.1 kg per tonne of aluminium [28, OSPARCOM 1997]. These emissions relate to plants where suction rates to the pots are constant, and where there is no provision for increasing them during hood-opening phases for anode change or metal tapping. Temporary increased suction

systems have been developed and are commonly known as boosted suction systems (BSS). BSS can reduce roof vent emissions to levels around 0.25 kg F/t Al plus 0.05 kg F/t Al (stack), thus, the total being 0.30 kg F/t Al.

Several aluminium smelters operating in Norway and Sweden use wet scrubbers (using seawater or caustic soda) in addition to the dry scrubber to remove sulphur dioxide (SO₂) from the cell exhaust gases (and in one case also from the roof ventilation gas). [28, OSPARCOM 1997]. [97, Lijftogt, J.A. et al 1998]. Cross-media effects from the use of wet scrubbers have to be considered.

Fluorides and chlorides are also emitted during the degassing and refining stages. The quantity and components of the emissions depend on the degassing and refining agents used.

4.2.3.2.3 PFCs (polyfluorocarbons)

The PFCs tetrafluoromethane (CF₄) and hexafluoroethane (C₂F₆) are formed during the anode effects. They are emitted in the ratio CF₄:C₂F₆ of approximately 10:1. They cannot be removed from the gas stream with existing technology once they are formed [28, OSPARCOM 1997].

The amount of PFCs generated is directly linked to the frequency and the duration of anode effects and to the overvoltage reached during them. The gases form an electrically isolating layer below the anode. This isolating film increases the cell voltage from 4–5 volts to 8–50 volts, thus significantly impacting the process efficiency. The control of cell voltage and alumina additions is a major factor in controlling anode effects [6, McLellan and Partners Ltd 1993].

The PFC emission from modern plants can be minimised by using semi-continuous point feeding of alumina, and by improved process control. These plants can be operated with an anode effect frequency of < 0.1–0.5 per pot per day and an anode effect duration of 0.5–2 minutes, resulting in PFC emissions ranging from 0.01 kg to 0.1 kg per tonne of aluminium [75, Nordheim, E. 1998] [97, Lijftogt, J.A. et al 1998]. PFC emissions can also be calculated with overvoltage methods. PFC emissions ranging from 0.01 kg to 0.1 kg per tonne of aluminium would correspond approximately to overvoltages of up to 1 mV. Many older plants use anode effects as a control for bath alumina content, and consequently PFC emissions can be much higher. The use of modern control systems and automatic point feeding of alumina in both prebaked and Söderberg cells minimises the number and duration of anode effects, [28, OSPARCOM 1997], [75, Nordheim, E. 1998]. In some cases, an automated anode effect killing system can also be used in conjunction with the control system, for example the use of anode height variation or compressed air.

In the late 1990s, considerable efforts were made by the European aluminium industry to lower PFC emissions. Advanced process control measures were implemented in order to closely control cell voltages and the alumina content in the cell, and therefore to avoid anode effects and limit the duration of any that do occur.

PFC emissions are regulated to a benchmark performance by EU ETS Phase III.

4.2.3.2.4 Tar and PAH

The emissions of tar and PAH during electrolysis in prebake plants are negligible due to the fact that the anodes are baked in a separate operation. Also, only very small amounts of tar and PAH may be emitted from a limited number of prebake plants using carbon paste for anode pin connection and for protection collars. Measurements at the start-up of new cells and from plants using collar paste indicate that emissions are negligible [97, Lijftogt, J.A. et al 1998].

Installations that include an anode production plant will have a source of tars and PAH from this part of the process. There are only two examples of the process gases from an anode plant sharing the same alumina scrubber and fabric filter as the electrolytic process. The results from these plants show no difference in performance of the abatement plant when anode process gases are included. It may be concluded therefore that the alumina scrubber is efficient at removing tar and PAH from an anode plant or from Söderberg cells. Spent alumina from the scrubbers is used as feed to the cells (but not for covering the bath).

In older plants, ESPs are also used to remove tar. Wet scrubbers for the ventilation gases will also remove some PAH, particularly the dust fraction, although SO₂ reduction (and sometimes fluoride) is normally the driver for installing this technology.

At Söderberg plants, tar and PAH are emitted during the electrolysis (anode consumption) and during the anode self-baking process. Emissions occur by evaporation of the paste and depend on the anode design, the paste quality and the operating practices. Emissions are abated in two different paths:

- emissions from the electrolysis are captured, burnt and eventually abated in dry scrubbers;
- emissions from the baking process are reduced by the use of dry paste combined with either an upper anode case or an anode top hood.

Reporting PAH emissions properly is a concern, as the trapping efficiency and the analytical errors on the lighter molecular weight fractions can be high. Many different standards and lists are used worldwide. Within the European aluminium industry, there is an increasing consensus for using BaP as a tracer for all other PAH.

4.2.3.2.5 Sulphur dioxide and sulphur compounds

The anodes used have a sulphur content ranging from 1 % to over 3.5 %. The sulphur is emitted as carbonyl sulphide (COS), which reacts with oxygen, resulting in the emission of sulphur dioxide and carbon monoxide. Due to the differences in the sulphur content of the anodes, the emissions of sulphur dioxide via the process gas from the cells can range from about 10 kg to 25 kg per tonne of aluminium, on a yearly basis, based on an anode consumption of 0.43 tonnes per tonne of aluminium for a prebake plant and of 0.48–0.50 tonnes per tonne of aluminium for a Söderberg plant. For COS, it has been reported that ~ 10–20 % of sulphur in the anode is formed into carbonyl sulphide, equivalent to 2 kg per tonne of aluminium for anodes that contain 2.5 % sulphur [348, Solios 2010]. In concentration terms, emissions via the process air from the cells have a typical concentration range from 50 mg/Nm³ to 400 mg/Nm³ [28, OSPARCOM 1997], [97, Ljiftogt, J.A. et al 1998]. These values depend on the specific flow rate, the anode consumption and the percentage of sulphur in the anodes. The values in concentration terms for Söderberg cells are higher, as the flows are significantly lower compared with those of prebake plants. A mass balance based on the sulphur content of the anodes and the alumina used has been reported as a method used in several countries to estimate emissions of SO₂.

In Norway and Sweden, where the process gas is wet scrubbed, SO₂ emissions are decreased to levels of 1–2.5 kg per tonne of aluminium. The concentration range in the emissions to air will typically be 5–40 mg/Nm³. Cross-media effects must be considered on a case-by-case basis if wet scrubbers are used.

The alumina used can also have an impact on SO₂ emissions. For instance, alumina that has been calcined using heavy fuel oil might have a sulphur content of up to 300 ppm and consequently 10–15 % higher SO₂ emissions [367, Authier-Martin et al. 2001].

The emissions of SO₂ via the pot room ventilation will range from 0.2 kg to 0.6 kg per tonne (concentration: 0.1–3 mg/Nm³), depending on the hooding efficiency.

It has been reported that sulphur in the anodes may have a beneficial effect in suppressing the adverse effects of sodium contained in the anode butts for recycling [75, Nordheim, E. 1998] [88, Nordheim, E. 1998]

European cokes, while being of consistent quality and good density, have the disadvantage that anodes made exclusively from these cokes have a shorter life and may cause smelter operational problems through excessive reaction with carbon dioxide, a phenomenon called dusting. In a modern computer-controlled smelter where stable operation and maximum power and cost efficiencies are the norm, this is unacceptable.

Low-sulphur cokes from Latin America and China show the same phenomenon and are also low in density. The CO₂ reactivity is suppressed by the presence of sulphur in increased quantities, so it is considered desirable and beneficial to blend European calcined petroleum coke with higher sulphur calcined coke from the US. This is a recognised and commonplace practice in European smelters, and limits the lower level of sulphur content of anodes used in Europe. Meanwhile, some smelters are testing calcined pitch coke in combination with calcined petroleum cokes which increase density and lower the sulphur content. The high sulphur value reduces dusting so, for some, this coke is considered preferable to all others. However, because of the higher sulphur content, US West Coast coke has not made major inroads into European markets.

4.2.3.2.6 Dust

Alumina and bath solid-related materials (cryolite, chiolite, crushed bath, anode cover mix, etc.) are the principal dusts emitted during electrolysis. Alumina that is used to remove fluorides from the exhaust gases is called secondary or fluorinated alumina and is also emitted if the dust collection system is not efficient. This secondary alumina will contain some HF adsorbed on the surface.

Total dust generation varies and depends on the type of process applied and the type of alumina, but ranges from 0.6 kg to 10 kg per tonne of aluminium. Typical dust concentrations for pot room ventilation are 0.5 mg/Nm³ to 5 mg/Nm³ whereas the dust concentration in the process air ranges from 150 mg/Nm³ to 500 mg/Nm³ before abatement and from 1 mg/Nm³ to 20 mg/Nm³ after abatement [97, Lijftogt, J.A. et al 1998].

Casting is another source of dust (and metals) and casthouse fumes are sometimes collected and treated in a bag filter. Gases emitted from the casthouse in primary smelters have been calculated and are shown in Table 4.11 [28, OSPARCOM 1997]. The calculation was based on the concentration of the components in the cell gases and the capture efficiency of the hood and extraction system. This calculation is relevant for establishing the significance of uncaptured emissions. To reduce the uncaptured emissions, an efficient fume capture system is used. Most smelters monitor this efficiency regularly.

Table 4.11: Primary aluminium casthouse emissions to air

Parameter	Emission (kg/t of aluminium)
Dust	0.01–0.1 ⁽¹⁾ ⁽²⁾
NO _x	< 0.1–0.4
SO ₂	0–1.8 ⁽²⁾
⁽¹⁾ Depending on filter system. ⁽²⁾ Depending on fuel used. Source: [272, Al input 2008]	

Some studies have been carried out on the presence of PCDD/F in fumes from the casting process as the use of chlorine for degassing and the presence of carbon from combustion gases may lead to their formation. All measurements from primary smelter casthouses show levels significantly below 1 g/yr. Regular measurements at a French smelter show typical values around 0.05 g/yr.

4.2.3.2.7 Metals

Metals are known to occur in trace concentrations in raw materials (alumina, aluminium fluoride, coke and pitch) and can therefore be emitted during electrolysis. Tellurium is extracted from alumina produced at one installation and is therefore a potential contaminant. Other volatile metals are also present and can be emitted from the pot room and the casthouse. A limited amount of information is available about the environmental impact, but trace metals are not considered to be a significant release. [97, Lijftogt, J.A. et al 1998], [367, Authier-Martin et al. 2001].

4.2.3.2.8 Oxides of nitrogen

Oxides of nitrogen (NO_x) are produced during electrolysis due to the presence of nitrogen in the anode, which can be oxidised to NO_x . The nitrogen content in the anodes generally ranges from 0.2 % to 0.4 %. When the nitrogen is completely converted into NO_x , the emission may be 0.5 kg to 2 kg NO_2 per tonne of aluminium (which would imply concentrations of 5 mg/Nm^3 to 20 mg/Nm^3 in the stack for flows of 100 000 Nm^3/h , and concentrations of up to 25 mg/Nm^3 for flows of 80 000 Nm^3/h). The actual amount of NO_x released is still subject to discussion. Control measurements at two prebake plants in Norway showed emission levels of 0.1 kg to 0.2 kg NO_2 per tonne of aluminium [97, Lijftogt, J.A. et al 1998]. The combustion gases from the burners used in holding and melting furnaces in the casthouse also contain oxides of nitrogen.

4.2.3.2.9 Carbon monoxide

Carbon monoxide (CO) is produced during electrolysis by the back reaction of aluminium metal dissolved in the electrolyte with the CO_2 produced at the anode ($2\text{Al} + 3\text{CO}_2 \rightarrow \text{Al}_2\text{O}_3 + 3\text{CO}$), which lowers the cell efficiency. In a modern smelter, the generation of CO before any reoxidation to CO_2 is in the order of 100 kg to 150 kg per tonne of aluminium. The production of CO also increases during an anode effect [6, McLellan and Partners Ltd 1993], [97, Lijftogt, J.A. et al 1998].

4.2.3.2.10 Carbon dioxide

Carbon dioxide (CO_2) is formed during electrolysis by the reaction of the carbon anode with the oxygen formed by electrolysis and by a secondary reaction with air. An efficient prebake plant consumes about 0.43 tonnes of carbon anodes per tonne of aluminium, corresponding to 1.4 to 1.7 tonnes of CO_2 per tonne of aluminium. These emissions are, however, far lower than the emissions of CO_2 from combustion of fossil fuels when used for the generation of the electrical power required for electrolysis [75, Nordheim, E. 1998]. Carbon dioxide is also emitted from burners used in the holding and melting furnaces.

4.2.3.2.11 Summary of main air pollutants

A summary of the relevance of the main air pollutants and their emission sources, as discussed above and based on literature findings, is given in Table 4.12

Table 4.12: Significance of potential emissions from primary aluminium production

Component	Flue-gases from electrolytic cells	Pot room ventilation	Degassing and holding
Fluorides (gaseous and total F)	•	•••	• (chlorides)
PFCs	•••	•	NR
Tars and PAH ⁽¹⁾	•	••	NR
SO ₂ (without scrubbers) ⁽²⁾ and COS	•• ⁽¹⁾	NR	•
Carbon dioxide	••	NR	NR
Dust	•	•	NR

⁽¹⁾ Tars and PAH are relevant to Söderberg processes and Prebake processes that have an integrated electrode production process. They can also be relevant for the small number of plants using paste for anode pin connection and for protection collars.
⁽²⁾ Wet scrubbers are generally used after dry scrubbing in Scandinavia to remove SO₂ and are usually associated with the use of seawater as the scrubbing medium.
 NB: ••• More significant – • Less significant.
 NR = Not relevant.

Total emissions to air from primary aluminium smelters are shown in

Table 4.13 and Table 4.14. Ranges represent the variations in terms of technology and plant age and size.

Table 4.13: Total emissions (roof + stack) to air from primary aluminium smelters with direct emissions of roof vents to the atmosphere and without wet scrubbing

Parameter	Prebake	Modified Söderberg
Total fluoride (kg/t Al)	0.46–1.1	0.5–1.5
Dust (kg/t Al)	0.6–1.7	0.9–4.0
SO ₂ (kg/t Al)	10–25	10–25
BaP (g/t Al)	Not reported	5–15

Source: [296, EAA, OEA 2012]

Table 4.14: Total emissions (roof + stack) to air from primary aluminium smelters with BSS for pot gas (prebake plants) or roof vent wet scrubbing (modified Söderberg)

Parameter	Prebake	Modified Söderberg
Total fluoride (kg/t Al)	0.25–0.45	0.30–0.60
Dust (kg/t Al)	0.2–0.6	0.8–1.4
SO ₂ (kg/t Al)	10–25	
BaP (g/t Al)	Not reported	5–15

Source: [296, EAA, OEA 2012]

When a wet scrubber is applied to pot gas, the performance shown in Table 4.15 can be achieved.

Table 4.15: SO₂ emissions to air from primary aluminium smelters with wet scrubbing applied to pot gas

Parameter	Prebake	Modified Söderberg
SO ₂ (kg/t Al)	1–2.5	0.8–2.5

Source: [296, EAA, OEA 2012]

The relevance of the uncontrolled emissions from the pot room ventilation is based on 98 % fume capture from the cells. Regular PFPB can achieve this efficiency, but when a lower efficiency is achieved, for example in SWPB or Söderberg cells, the relevance of the pot room ventilation increases [75, Nordheim, E. 1998], [97, Lijftogt, J.A. et al 1998].

4.2.3.3 Emissions to water

The production of primary aluminium is inherently a dry process. The discharge of waste water is usually limited to cooling water, rainwater run-off from surfaces and roofs, and seawater from scrubbing pot room ventilation gases. The rainwater run-off can be contaminated by the open storage of raw materials and deposited solids. Typical values for this contamination are < 0.03 kg/tonne of aluminium for suspended solids and < 0.02 kg/tonne of aluminium for dissolved fluoride. In addition, considerable amounts of waste water can be discharged when wet systems are used for air pollution control [97, Lijftogt, J.A. et al 1998].

Anode production can account for the production of some waste water, consisting of cooling water used to cool the green anodes and green Söderberg paste or the flue-gases. Also, the cooling process may be performed using indirect water systems, resulting in a discharge of cooling water, although, in modern smelters, this water is recycled, resulting in almost zero discharge. Indirect water systems can also be used to cool the flue-gases, to make them suitable for abatement with regular techniques (fabric filters, electrostatic precipitators) [97, Lijftogt, J.A. et al 1998].

The electrolysis stage is a dry process and no waste water is produced directly. Rainwater contamination is prevented by the techniques outlined in Section 0.

In modern smelters with dry alumina scrubbers, water discharge is usually as low as 1 m³ per tonne of aluminium. In plants where water is used once through as a cooling agent, mainly in order to reduce the energy cost of evaporation cooling towers, water discharge may be as high as 100 m³ per tonne of aluminium.

Emissions to water from the primary aluminium electrolysis plants using ventilation air wet scrubbers or SO₂ wet scrubbers are shown in Table 4.16.

Table 4.16: Process emissions to water from the primary aluminium electrolysis plants using ventilation air wet scrubbers or SO₂ wet scrubbers

Parameter	Söderberg
Fluorides (kg/t Al)	0.5–1.5
Suspended solids (kg/t Al)	0.5–2.0
PAH (Borneff 6) (g/t Al)	6–15
<i>Source: [272, Al input 2008]</i>	

PAH emitted to water might be reported as the six compounds in the Borneff list [28, OSPARCOM 1997], [125, Euroalliances (B) 1998].

4.2.3.4 Process residues

The production of metals is related to the generation of several by-products, residues and wastes, which are also listed in the European Waste Catalogue. The most important process-specific residues are described in Sections 4.2.3.4.1 and 4.2.3.4.2 below.

The main sources of waste from electrolysis are spent pot lining (SPL) materials.

4.2.3.4.1 Spent pot lining

With a cathode lifetime of five to eight years, which is common for modern plants, the quantity of spent pot lining (SPL) generated is 20–50 kg per tonne of aluminium produced. The SPL normally consists of two distinct fractions plus steel cathode bars. The two wastes are the carbon part (first cut) and the refractory material (second cut). The carbon part is the actual cathode from the electrolytic cell, and the remainder is varying types of insulating material [272, Al input 2008].

The two fractions are often separated when dismantling the cathode. The spent cathode also contains some bath material, steel bars used to conduct electricity to the carbon cathode, and often flakes of aluminium metal from metal penetration into the cathode. These parts are either reused directly at the plant or, in the case of steel bars, sent outside the plant for recycling. The carbon part is relatively homogeneous, while the refractory part can be composed of a number of different types of refractory materials or other types of insulation.

Table 4.17 gives an analysis of typical SPL.

Table 4.17: Composition of spent pot lining

Compound	Carbon lining (1 st cut)	Insulation (2 nd cut)
	Range (wt-%)	
Al ₂ O ₃	0–10	10–50
C	40–75	0–20
Na	8–17	6–14
F	10–20	4–10
CaO	1–6	1–8
SiO ₂	0–6	10–50
Metallic Al	0–5	0
CN (total)	0.01–0.5	0–0.1
CN (free)	0–0.2	0–0.05
<i>Source: [131, Nordheim 1998]</i>		

The constituents of concern linked to this material are soluble fluoride and soluble cyanide. In addition, any wetting of this material will produce an alkaline leachate and liberate minor quantities of NH₃ and flammable gases. PAH are not considered to be a problem since the carbon lining has already been carbonised at temperatures above 1250 °C and any ramming paste has been heated to above 900 °C in the electrolytic cell. The constituents mentioned are mainly linked to the carbon part of the SPL and the refractory parts in immediate contact with this. As can be seen from Table 4.17, the content of these constituents is lower in the refractory part or other types of insulation.

SPL can be reused, treated, partially treated or disposed of [131, Nordheim 1998]

Reuse

Available recovery routes for most European smelters are:

- reuse in cement manufacturing;
- reuse as a secondary raw material (rock wool, salt slag recovery, etc.);
- reuse as a fuel;
- reuse as a carburiser (steel industry).

Treatment processes

- Rio Tinto Alcan low caustic leaching and liming (LCLL);

- Ausmelt/ISASMELT furnace;
- Elkem ferro-alloy process [226, Nordic Report 2008]
- An emerging technique developed by BEFESA, described in Section 4.4.

Disposal

Pretreat followed by disposal in a disposal site that is compliant with EC Directive 1999/31/EC.

4.2.3.4.2 Other materials

Skimmings/dross from the holding and treatment processes represent 15–30 kg per tonne of aluminium produced. This material contains 30–80 % aluminium. Cooling under an inert gas blanket prevents oxidation. Skimmings/dross are used as a raw material in the secondary aluminium industry. Spent filters from metal treatment are usually disposed of. Solid wastes produced by gas-cleaning installations (dust and sludge) can be [75, Nordheim, E. 1998].

In rare cases, anode butts from some plants are also disposed of if they fail to meet quality standards. If there is no anode plant on site, anode butts can be used in the steel industry as a coke substitute, therefore lowering primary coke demand.

Spent anode shot blasting and cleaning residues, containing mainly carbon and cell bath, are also dealt with in most of the smelters, as well as dust from floor sweeping and basement cleaning materials, which consist mainly of a mix of alumina and bath particulates. These materials are often recycled internally or disposed of when they do not meet the minimum quality standards.

Furnace linings from metal ladles and anode baking furnace bricks may be recovered or disposed of. Refractory bricks from the baking furnaces can be reused in other applications after cleaning or can be disposed of as waste. Typical furnace lining life for prebaked anodes is about 100 cycles and this represents approximately 10 kg of bricks per tonne of anode produced.

Good waste management practice and the use of recovery methods make it possible to reduce the amount of waste sent for disposal. Options and quantities are shown in Table 4.18 and Table 4.19.

Table 4.18: Options to reduce waste in a primary aluminium smelter

Source	Use/treatment options
Aluminium	Recovery
Filter dust	Reuse in process
Bricks	From anode furnaces, reuse
Steel	Recovery
Carbon dust (anode plant)	Reuse or landfill, depending on the ash content
<i>Source: [272, Al input 2008]</i>	

Table 4.19: Specific waste quantities from primary aluminium production

Source ⁽¹⁾	kg/t of aluminium
Al skimmings/dross	15–30
Other hazardous waste	7–15
Non-hazardous waste	12–14
⁽¹⁾ Provided no external scrap is melted.	
<i>Source: [272, Al input 2008]</i>	

Steel from the anode plant is normally remelted in an induction furnace and recast for use in the process. The melting of steel that is contaminated with fluorides is a further potential source of these emissions and appropriate collection and abatement is required.

4.2.4 Secondary aluminium

The type and quality of scrap have a major influence on the significance of the emissions. There are potential emissions to air of dust, metal compounds, Cl_2 , HCl , NO_x , SO_2 and HF and products of poor combustion such as PCDD/F and other organic compounds from the melting and treatment furnaces. The formation of PCDD/F in the combustion zone and in the cooling part of the off-gas treatment system (de novo synthesis) may be possible.

Figure 4.9 gives an overview of the typical input and output of a secondary aluminium plant.

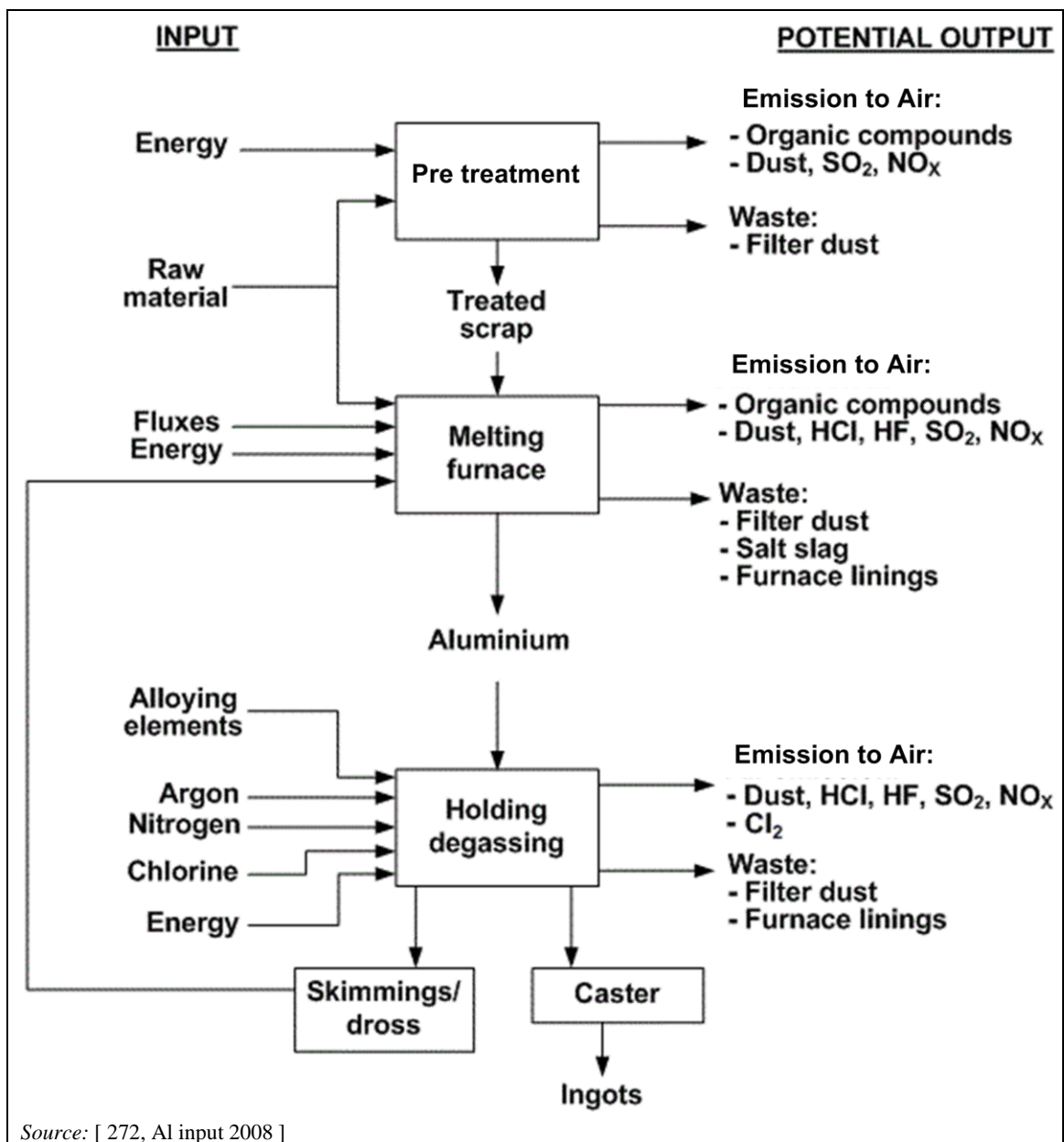

Figure 4.9: Input and output from secondary aluminium production

The emissions can escape the process either as stack emissions or as diffuse emissions, depending on the age of the plant and the technology used. Stack emissions can be monitored continuously, such as dust, or periodically, such as PCDD/F, and reported by on-site staff or off-site consultants to the competent authorities.

Ammonia and other gases can be emitted from the reaction with humidity in the air, due to improper storage or treatment and from the transport of skimmings/dross [32, Mantle et al. 1998]. Dust will also arise from the handling and treatment of the skimmings/dross. There are potential emissions to water of suspended solids, metals and oils in the event of improper product and material storage.

4.2.4.1 Emissions to air

The potential emissions to air are shown in Table 4.20 and are:

- dust, PM₁₀ and PM₅;
- metal compounds;
- organic compounds (TOCs and PCDD/F) and CO;
- oxides of nitrogen (NO_x);
- sulphur dioxide (SO₂);
- chlorine, hydrogen chloride and hydrogen fluoride (Cl₂, HCl and HF).

A significant proportion of the emissions of these substances is produced from contamination of the feed material and from the fuel used. Some dust is produced by fine dusty scrap and by salt fumes REFERENCE BOOKMARK 8151[75, Nordheim, E. 1998]

Table 4.20: Significance of potential emissions to air

Component	Pretreatment	Melting	Molten metal treatment and degassing
HCl, HF and Cl ₂	••	••	•••
Metals and compounds	••	••	••
Oxides of nitrogen	•	••	• (combustion gases)
SO ₂	• (with suitable fuel)	• (with suitable fuel)	• (combustion gases)
Organic compounds (CO, TOCs, PCDD/F)	•••	•••	NR
Dust	•••	•••	••
NB: •• More significant – • Less significant. NR = Not relevant.			

4.2.4.1.1 Collection and prevention of emissions

In aluminium remelting/recycling plants, diffuse emissions mainly arise during the storage, handling and loading/unloading of dust-emitting materials (e.g. slag), and as a result of the insufficient capture of furnace off-gases, particularly when the furnace is open (e.g. for charging, melt treatment, slag tapping, skimming and casting). Diffuse emissions occurring in the process during charging, melt treatment, slag tapping, skimming and casting are subsequently emitted from the buildings, e.g. via open doors or ventilation openings in the roof (roof lights), if no extraction devices of sufficient capacity are available. [234, UBA (D) 2007].

Fume extraction is an important element of secondary aluminium production, as dust and smoke can be formed from contaminants in the feed, as well as during the combustion and melting stages [32, Mantle et al. 1998]. The presence of several possible emission points in a furnace is also significant, and the collection of the emissions from such points should be addressed. In

addition, various systems may be employed to reduce diffuse emissions during the charging phase of the process. For example, docking cars that seal against the charging door can be used to prevent emissions during charging.

Another important factor is the combustion of organic coatings in the pretreatment or melting furnace. Extraction and abatement systems can be designed to treat these emissions. Diffuse emissions can be significant though unless the fume collection systems are well designed.

4.2.4.1.2 Dust and metals

Dust is generated mainly by the composition of the input material (skimmings/dross and fine dusty scrap) and by salt fume. Incomplete combustion of fuel may contribute to dust emissions too. Dust is also generated when handling, e.g. storing, loading and charging the input materials, such as scrap, fluxes and skimmings/dross. Dust will also arise from the pretreatment of the skimmings/dross, e.g. cold milling. On-site mechanical treatment of salt slag such as crushing generates dust as well.

Dust and metals occur together and can be produced from the combustion gases or from the scrap or fluxes used. Some metals, which are present as contaminants of raw materials such as Cu, Mg, Zn and Hg, will be fumed off during melting and will form dusts.

The production of smoke is due to the presence of organic carbon and the presence of chloride and may lead to the formation of PCDD/F which will then also be associated with the particles [312, VDI 2008].

Treatment materials such as lime, sodium bicarbonate and carbon are injected into the raw gas stream to reduce emissions of acid gases and PCDD/F and they are removed by filters together with dust. Most installations use (high-efficiency) bag filters to remove dust; emissions range from below 0.6 mg/Nm³ to 5 mg/Nm³. A spark arrester or cooling chamber often precedes them to provide filter protection. The emissions of metals depend on the raw materials used and the dust levels achieved.

In Table 4.21, an overview of dust emissions from secondary aluminium production is reported.

Table 4.21: Dust emissions from secondary aluminium production

Source	Emission control	Dust (mg/Nm ³)
		Min.–max.
Material (scrap, dross) mechanical treatment (crushing, milling), loading, transporting ⁽¹⁾	Bag filter	< 1–5
Swarf dryer	Bag filter	< 1–5
Different types of furnaces	Bag filter	< 1–5
⁽¹⁾ Loading refers to loading and unloading of trucks with salt slag and dross. Transporting refers to the conveyor transfer points. [296, EAA, OEA 2012]		

4.2.4.1.3 Organic compounds (TOC, PCDD/F) and CO

Poor combustion of fuel or the organic content of the feed material can result in the emission of organic compounds. The provision of effective burner and furnace controls is used to optimise combustion. Peak combustion rates from organic compounds need to be taken into account if they are fed to the furnace. It is reported that precleaning of scrap removes much of the organic

material and improves the melting rate [119, McLellan 1998]. The use of chlorine and chlorides (salt flux) provides a source of chlorine and hence the potential for the formation of PCDD/F in the combustion zone and in the cooling part of the off-gas treatment system (de novo synthesis).

The use of modern regenerative burners can prevent or minimise de novo synthesis. Efficient dust filtration removes organic compounds and the PCDD/F that are associated with dust; carbon may be added to increase the cleaning efficiency. Afterburning of the off-gases may also be carried out to destroy organic compounds produced in the furnace or in pretreatment stages.

In Table 4.22 an overview of PCDD/F and TVOC emissions from secondary aluminium production is reported.

Table 4.22: PCDD/F and TVOC emissions from secondary aluminium production

Source	Emission control	PCDD/F (ng I-TEQ/Nm ³)	Source	Emission control	TVOC ⁽¹⁾ (mg/Nm ³)
		Min.–max.			Min.–max.
Different types of furnaces	Activated carbon injection and bag filter	< 0.1–0.44	Swarf dryer	Afterburner	< 1–32
Different types of furnaces	Afterburner/activated carbon injection with bag filter	< 0.01–0.22	Different types of furnaces	Afterburner	0.5–18

(¹) Peak value from continuous measurement.
 Source: [296, EAA, OEA 2012].

4.2.4.1.4 Sulphur dioxide and oxides of nitrogen

Both of these compounds are produced as a result of the sulphur and nitrogen contents of the raw materials, fuels and combustion systems used in the furnaces. For example, salt fluxes can contain sulphate. Low-NO_x burners and low-sulphur fuels can be used to minimise emissions. The use of oxy-fuel burners can reduce the formation of thermal NO_x, but there is a possibility that oxygen enrichment might have the opposite effect due to the higher operating temperatures. Similarly, preheating the combustion air will also increase concentrations of NO_x, which is measured as NO₂. Higher concentrations are associated with lower gas volumes and overall quantities. Preheating combustion air in regenerative or recuperative burners may also increase emissions of NO_x. A correct correlation between NO_x emissions and the effect of the oxy-fuel or oxygen enrichment can only be calculated by comparing the amount of pollutant emitted per tonne of aluminium produced each cycle.

SO₂ emissions in all cases depend on the type of fuel used, which itself depends on the availability of the fuel in the region where the plant operates. The yearly average SO₂ emission does not exceed 100 mg/Nm³.

In Table 4.23, an overview of NO_x (measured as NO₂) emissions from secondary aluminium production is reported.

Table 4.23: NO_x (measured as NO₂) emissions from secondary aluminium production

Source	NO _x (mg/Nm ³)
	Min.–max.
Swarf dryer, normal burner	10–150
Different types of furnaces, oxy-fuel burner	1–300
Different types of furnaces, normal burner	< 1–200
Different types of furnaces, regenerative burner	72–340
<i>Source:</i> [296, EAA, OEA 2012].	

4.2.4.1.5 HF, HCl and chlorine

Chlorine may be used to treat molten aluminium before casting to remove hydrogen, magnesium (demagging) and other impurities. One possible use of rotary furnaces is to remove magnesium without using any further chlorine. This is useful as an excess of chlorine could end up being emitted as chlorine or aluminium chloride. The latter can hydrolyse with humidity in the air to produce HCl. Most sites use dry or semi-dry scrubbing to remove these compounds and only a few use wet scrubbers. Their formation can be minimised by good control and by using mixtures of chlorine and inert gases instead of pure chlorine. The use of salt cover in a melting furnace can also result in the emission of very fine fumes that contain metal chlorides. The use of fluorides for demagging or as a flux can result in the release of HF and fluorides in small quantities.

In Table 4.24, an overview of HCl, Cl₂ and HF emissions from secondary aluminium production is reported.

Table 4.24: HCl, Cl₂ and HF emissions from secondary aluminium production

Source	Emission control	HCl (mg/Nm ³)	Cl ₂ (mg/Nm ³)	HF (mg/Nm ³)
		Min.–max.	Min.–max.	Min.–max.
Different types of furnaces	Lime injection and/or NaHCO ₃	< 1–16.3 ⁽¹⁾	< 0.1–2.1	< 0.1–2.5
Hearth/induction furnaces	Lime injection	0.1–7	0.1–0.23	< 1
⁽¹⁾ Measured during chlorination. <i>Source:</i> [296, EAA, OEA 2012].				

4.2.4.2 Emissions to water

The production of aluminium from secondary raw materials is essentially a dry process. Any discharge of waste water is usually limited to cooling water, which is often recirculated, and rainwater run-off from surfaces and roofs. A closed water circuit returns the used water to the process; only water used to cool the metal is evaporated to the atmosphere and is regarded as lost and must be replaced. Sometimes fresh water is added to maintain the cooling water below a certain temperature for safety reasons. The cooling water basin of a closed loop system will collect some contaminants due to abrasion in the equipment and as precipitation products originating from water conditioning. These contaminants collect in the basin and have to be discharged from time to time. As they are not toxic or otherwise harmful to the environment they are usually passed on to public waste water treatment plants. Similarly, considerable

amounts of water are used when wet systems are used for air pollution control. However, the waste water is often purified and recirculated within the system.

The rainwater run-off can be contaminated by the open storage of raw materials such as oily scrap and deposited solids. Typical values for this contamination are < 0.03 kg/tonne of aluminium for suspended solids. In addition, considerable amounts of waste water can be discharged when wet systems are used for air pollution control. Waste water from swarf washing is also recirculated inside the plant.

The main sources of the waste water in secondary aluminium production are:

- surface water;
- water from swarf washing (usually completely reused);
- waste water from gas treatment;
- cooling water from casting ($0.15\text{--}0.3$ m³/t Al).

4.2.4.3 Process residues

Typical residues from secondary aluminium production are shown in

Table 4.25.

Table 4.25: Typical residues from secondary aluminium production

Residue	Origin	Volume	Treatment	Driving force
Salt slag	Melting in rotary furnaces	Up to 500 kg/t Al	Recovery via dissolution and crystallisation techniques. Production of reusable substances: Al metal granulate, mixed salt, non-metallic oxidic products	Salt is not used in all furnaces. Ban on landfill
Filter dust	Exhaust gas cleaning	Up to 35 kg/t Al 0.1 to 10 kg/t Al ⁽¹⁾	Disposal with pretreatment or to underground site, partly reconditioned with salt slag or used in the steel industry	Ban on surface disposal in some countries, thermal treatment possible (neutralisation with NaHCO ₃ or Na ₂ CO ₃ → use with salt slag)
Furnace lining	Melting furnace	Up to 4 kg/t Al	Potential for reconditioning with skimmings/dross, otherwise leaching and landfill	Aim to prevent landfill. Recycle to produce moulds
Skimmings or dross	Cleaning of smelter and foundries	Up to 80 kg/t Al ⁽²⁾	Smelting in rotary furnace. Recovery, pellets used in rotary drum furnace, dross dust used in the recovery of salt slag	Ban on landfill
Grease/oil	Swarf washing/centrifugation		Collection and separation	Oil recycling

⁽¹⁾ Non-metallic products (oxide compounds from Al scrap).
⁽²⁾ Using a closed well furnace provided no external scrap is melted.
Source: [142, Boin, U. et al. 1998], [234, UBA (D) 2007], [256, Winter 2007].

Skimmings/dross

Skimmings/dross from the holding and treatment processes occur in amounts of 15–30 kg per tonne of aluminium produced, and contain a significant amount of aluminium, around 20–80 %.

Skimmings/dross are used as a raw material in parts of the secondary aluminium industry. Sometimes hot skimmings/dross are directly charged to the furnaces for recovery of aluminium metal. Mostly, they are cooled and pretreated as soon as they are removed from the furnace, to reduce emissions and prevent further oxidation of the metal present and to separate aluminium from aluminium oxide. Methods include inert gas cooling, hot pressing to remove molten aluminium, and cooling in purpose-built coolers [312, VDI 2008].

During storage, skimmings/dross can react with moisture (from the air) to produce ammonia and other gases.

Cold skimmings/dross are further treated by a number of processes to recover aluminium. Rotary or tilting rotary furnaces [256, Winter 2007], are used to recover aluminium from skimmings/dross and the metallic fraction produced from it. Salt flux is usually used to facilitate this process, as it reduces oxidation and promotes the removal of some impurities (e.g. Mg, Ca, Li). Salt slag is generated and treated in salt slag recovery processes. Another further treatment is the use of separation techniques such as milling and processing, e.g. air classification, to separate oxide from the metal. Using the separation techniques, the metal can be remelted in relevant furnaces and the fine fraction can be further processed, e.g. recycled in the steel industry or in the salt slag recovery process. It has been reported that the final generation of salt slag and waste is reduced and the use of energy is lower due to a lower burden of inert material in the furnace. Skimmings/dross recovery processes are shown in Figure 4.10.

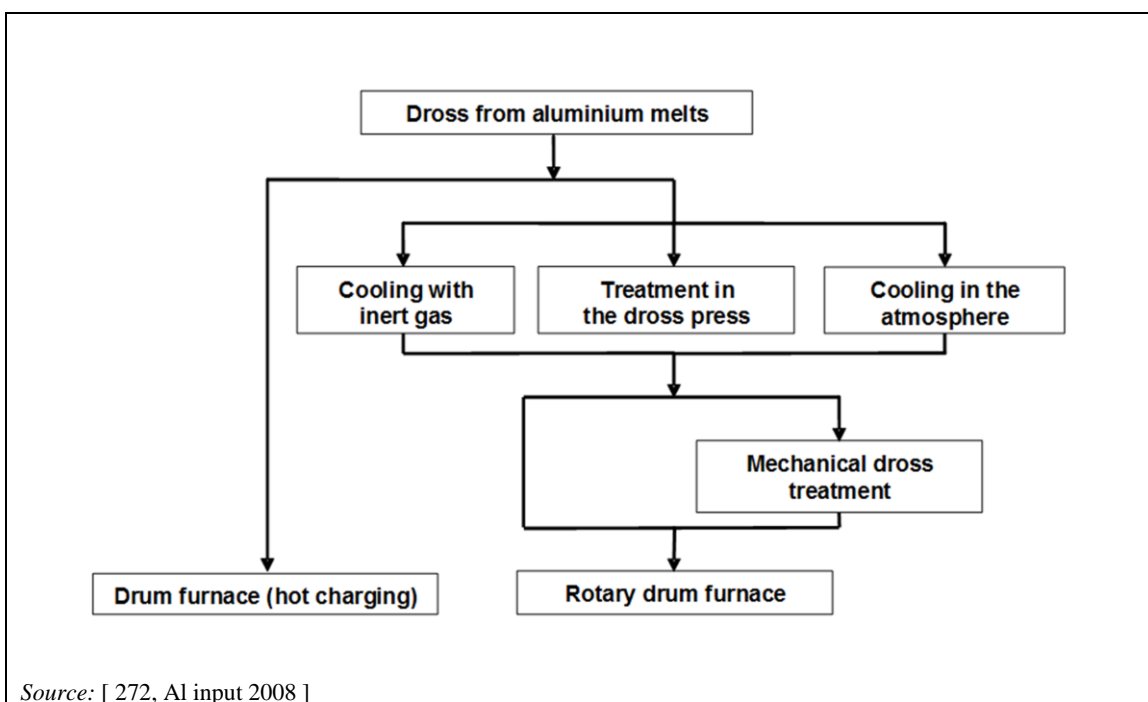

Figure 4.10: Skimmings/dross recovery processes

Figures relating to the emissions from the treatment of skimmings/dross are shown in Table 4.26.

Table 4.26: Emissions from skimmings/dross treatment

Emissions	Range
Dust (mg/Nm ³)	1–5
Dust (kg/t) ⁽¹⁾	300–700
Energy consumption (MJ/t)	300–800
⁽¹⁾ The quantity of dust depends on the metallic content of the original skimmings/dross. Source: [272, Al input 2008]	

Spent filter and filter dust

Spent filters from metal treatment are usually disposed of. In some cases, when sodium bicarbonate is used for gas cleaning, solid residues can be recovered with the salt cover [2, McLellan et al. 1993], [32, Mantle et al. 1998], [142, Boin, U. et al. 1998], [312, VDI 2008]

Alternatively, filter dust can be treated thermally to destroy PCDD/F. The typical composition of filter dust from secondary aluminium production is shown in Table 4.27.

Table 4.27: Typical composition of filter dust from secondary aluminium production

Contents	Typical value (%)	Range (%)
CaO	25	0–50
Al ₂ O ₃	15	6–25
NaCl, KCl	35	20–50
Carbon	6	1–6
Metals ⁽¹⁾	-	0.01–10
Al metal	3	2–7
PCDD/F as I-TEQ	5 µg/kg	3–10 µg/kg
⁽¹⁾ Zn, Pb, Cu, Mn, V, Cr, Ni, Sn, (and in traces: Co, As, Tl, Be, Sb). Source: [142, Boin, U. et al. 1998]		

Furnace linings

Furnace linings and dust can be recovered in salt slag treatment processes or disposed of.

Salt slag

When used salt flux is tapped from the furnace (at this stage called salt slag) it contains large amounts of aluminium oxide, which the flux has separated from the raw materials. Of the total weight of the salt slag, 4–10 % is metallic aluminium. The sodium and potassium chlorides can be recovered for further use, using separation and crystallisation processes. In most salt slag recycling plants the oxide portion is sold, after a washing stage, to the cement or mineral wool industry.

Both filter dust and salt slag are recycled, which means that all the solid wastes generated by the secondary aluminium industry can be recovered, avoiding the need for landfill.

4.2.4.4 Energy consumption

Many factors influence the energy demand for processing scrap to secondary aluminium products. The furnace design and efficiency affect energy consumption, as they do in all similar industry processes. For secondary aluminium production, there are a few specific factors, as discussed below.

The quality of scrap to a large extent determines the choice of furnace as well as the energy consumption. In principle, contaminated scrap requires the addition of salt, which needs to be melted together with the scrap, thus resulting in higher specific energy consumption than for less contaminated scrap. The melting of salt demands roughly the same amount of energy as for melting the metal, i.e. every 100 kg salt used increases the energy consumption by 10 % per tonne of product.

Some contaminated scrap such as swarf will need to be pretreated before melting. On average, the washing and drying of swarf consume a similar amount of energy as the melting and molten metal treatment process. Some briquetting, especially of fine swarf, may also help to reduce the loss of metal when it is subsequently being melted.

Secondary casting alloys can be produced in the form of ingots and liquids (transported in crucibles). The additional energy required to heat the liquid to a higher temperature and to heat the crucible is in the range of 20–30 %. A benefit of this liquid metal delivery, apart from meeting foundry demands for just-in-time services, is that no remelting is needed at the foundry, thus the overall energy consumption of the final casting products is reduced.

Secondary wrought alloys may be produced in the form of slabs and billets. In many cases, a homogenisation process needs to be carried out at the secondary plant before the production is finalised. The energy consumption for this process is in the range of 1–1.6 GJ per tonne of aluminium depending on the alloys required by the customers.

In summary, the specific energy consumption of secondary aluminium products ranges from 2 GJ/tonne to 9 GJ/tonne. Although the recycling of the lower quality scraps usually requires more energy, secondary aluminium production consumes only 5 % of the energy needed for the production of primary aluminium.

4.2.4.5 Mass stream overview and input/output data

The range of the typical plant, process and emission parameters (raw gas) of aluminium smelting plants is shown in Table 4.28.

Table 4.28: Range of the typical plant, process and emission parameters (raw gas) of secondary aluminium production plants

Parameter ⁽¹⁾	Unit	Rotary drum furnace	Tilting rotary furnace	Closed well or Hearth furnace		Shaft furnace	Crucible furnace	Channel induction furnace	
				Single chamber	Multiple-chamber, hearth furnace with melting bridge				
Preferred application		Production of secondary aluminium	Production of secondary aluminium	Production of secondary aluminium, foundries		Production of secondary aluminium	Moulding shops	Moulding shops	Production of secondary aluminium
Purpose		Melting	Melting	Melting	Holding, casting	Melting	Melting, holding	Melting, holding	Melting, holding
Preferred feedstock		New scrap (thin-walled, in small pieces), old scrap, dross	Old scrap, dross	Ingots, new/old scrap	Molten metal	Thin-walled new/old scrap (painted/coated)	Ingots, new scrap (recycled material)	Ingots, new scrap	Ingots, new/old scrap
Preferred melt treatment		Salt cover	Reduced salt cover compared to rotary drum	No salt cover, chlorination		No salt cover	No salt cover	No salt cover	No salt cover, chlorination
Capacity	t	Up to 150	Up to 30	Up to 180		Up to 180	0.5–4 (possibly up to 15)	0.1–0.6 ^(b) , 0.5–6 ^(c) , 0.1–1.2 ^(a)	Approximately 50
Melting efficiency	t feedstock/h	Up to 20	Up to 7	Up to 30	NA	3–28	Up to 2.5 (typically 1.5)	0.075–0.26 ^(b) , 0.25–3 ^(c) , 0.1–0.43 ^(a)	Approximately 7 (melting efficiency)
Preferred fuels		Natural gas, LPG, light fuel oil, medium/heavy fuel oil	Natural gas, LPG, extra-light fuel oil	Natural gas, LPG, extra-light fuel oil		Natural gas, LPG, extra-light fuel oil	Natural gas, LPG, extra-light fuel oil	Natural gas, LPG, extra-light fuel oil or electrically heated	Electrically heated
Energy use ⁽⁵⁾	GJ/t metal	2–4.7	2–2.5	2.5–4.4	No details	2.4–4.3	2.1–3.3 (depending on the mode of operation)	5.1–7.4 (M), ^(a) , 1.7–3.5 (H), ^(a) , 2.7/1.9–2.1 (M), ^(b) / ^(c) , 0.4/0.9–1.2 (H), ^(b) / ^(c)	Approximately 3.6 (M/H)
Waste gas rate ⁽⁵⁾	m ³ /t metal	9000–18 000	9000–13 000	5000–13 000	No details	10 000–15 000	2000–4000	2000–4000 (M), ^(a)	Max. 14 500
Dust generation		+++	+++	++	+	++	NR	NR	+
Nitrogen oxides ⁽³⁾		+ (assuming optimised combustion conditions) or ++ (for fuel-/oxygen-heated furnaces)						NR	NR
Sulphur dioxides ⁽³⁾		NR							

Parameter ⁽¹⁾	Unit	Rotary drum furnace	Tilting rotary furnace	Closed well or Hearth furnace		Shaft furnace	Crucible furnace	Channel induction furnace	
				Single chamber	Multiple-chamber, hearth furnace with melting bridge				
Chlorine ⁽⁴⁾				++ (chlorination)					
Hydrogen chloride ⁽⁴⁾		+++	++	+, ++ (chlorination)	+, ++ (chlorination)	++	NR	++ (chlorination)	++ (chlorination)
Hydrogen fluoride		+++	++	+	+	+	NR	++	+
Total organic carbon ⁽²⁾		++	++	+	+	+	NR	NR	NR
PCDD/F ⁽²⁾		+++	++	++	NR	+	NR	NR.	NR

⁽¹⁾ Relevance of process emissions: +++ high, ++ moderate, + low, NR not relevant (e.g. because of very low melting rate).

⁽²⁾ Primarily dependent on type and composition of feedstock.

⁽³⁾ Primarily dependent on firing (choice of fuel, flame control).

⁽⁴⁾ Primarily dependent on type and extent of melt treatment, *inter alia* dependent on variables such as metal yield, air preheating, plant capacity utilisation.

⁽⁵⁾ Overall plant (sum of energy needs for treatment, smelting and holding, inclusive of auxiliary energy).

(M) For melting furnace.

(H) For holding furnace.

^(a) Fuel-heated crucible furnaces.

^(b) Resistance-heated crucible furnaces.

^(c) Inductively heated crucible furnaces.

NB: NR = Not relevant, NA = Not applicable.

Source: [312, VDI 2008], [296, EAA, OEA 2012]

4.2.5 Salt slag

Aluminium salt slags (also referred to as aluminium salt cake or black dross) are hazardous wastes and are usually [361, Spain 2013] not suitable for landfill. As they create harmful gases when wet, they should be stored under cover and on concrete floors to avoid leaking into the drainage.

An example input and output mass flow of a salt slag recovery process is shown in Figure 4.11, and Table 4.29 presents the typical composition of outputs from various salt slag recovery processes.

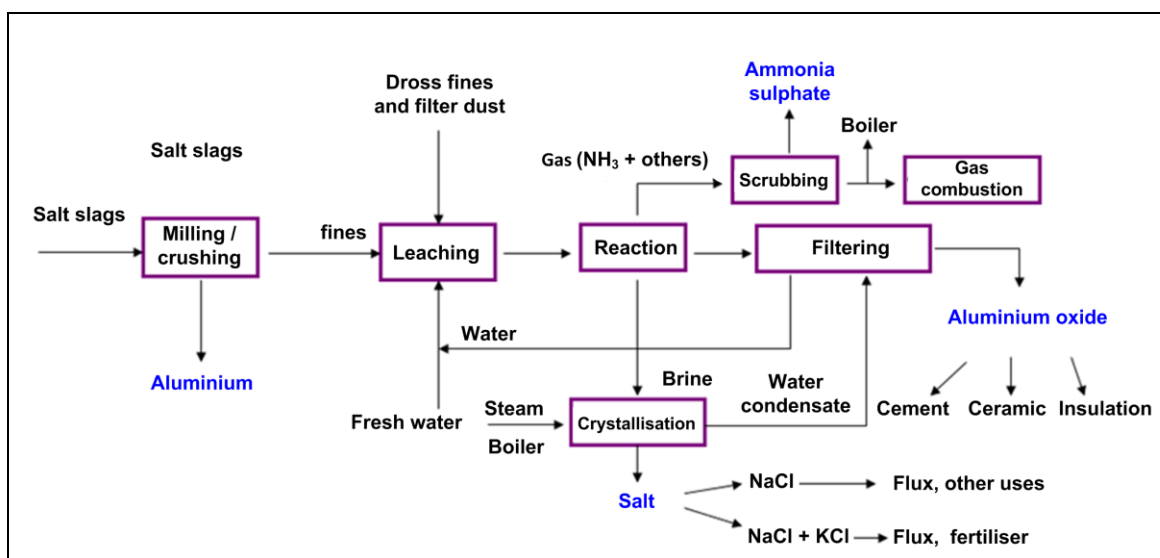

Figure 4.11: Mass flow of a salt slag full recycling process

Table 4.29: Typical outputs from salt slag recovery

Process	Intermediate product or residue	Quantity (t/t of salt slag)	Use or disposal option
Full recycling	Aluminium granulate	0.04–0.1	Sale or internal use in secondary Al melter
	Salt (NaCl/KCl)	0.2–0.55	Sale or internal use in secondary Al melter
	Aluminium oxides	0.46–0.68 ⁽¹⁾	Sale to brick, ceramics, clay, cement and mineral wool industries
	Ammonium sulphate	0.08	Sale to fertiliser industry
Partial recycling	Aluminium granulate	0.08	Sale to secondary Al melter
	Salt (95 % KCl)	0.09	Sale to fertiliser industry
	Leaching residue (including 20 % moisture, aluminium oxides, NaCl)	0.97	Cover layer for tailing piles; disposal in a deposit in or on land or in permanent storage
	Ammonium sulphate	0.03	Sale to fertiliser industry
	Phosphate solution (waste gas treatment)	0.07 m ³ /t salt slag	Sale to fertiliser industry

⁽¹⁾ Wet product.
Source: [234, UBA (D) 2007], [296, EAA, OEA 2012]

4.2.5.1 Dust and other emissions to air

Gases arise from all the wet stages of the process, mainly hydrogen and methane, but also minor amounts of ammonia, phosphane and hydrogen sulphide. All these process emissions are collected and cleaned, and the ammonia is separated to produce ammonium sulphate (solution or salt) for sale. It is also possible to use some of these gases as a fuel, to generate heat for other parts of the process [113, ALFED 1998]. In some plants, all grinding stages are carried out under dry conditions, so there is no gas emission in this stage except dust recovered in a bag filter. Also, diffuse emissions of dust from the crushing of salt slag can be highly significant, and grinding installations should be sealed in order to avoid dust leaking out. In others, the final stage is carried out using water, in which case an activated carbon filter is used to reduce potential emissions of phosphane and hydrogen sulphide [267, BEFESA 2008].

Dust is generated in different plant sections, especially during all the dry crushing and grinding stages. Diffuse emissions of dust from the crushing of salt slag can be substantial. Grinding installations should be sealed in order to avoid dust leaking out. All off-gases are treated in a bag filter and the separated dust is sent directly to the dissolvers.

In Table 4.30 typical collected air and dust emissions from salt slag recycling plants (excluding boiler exhaust, if fitted) are shown.

Table 4.30: Collected air and dust emissions from salt slag recycling plants

Source	Emission control	Dust	Ammonia	Phosphane	Hydrogen sulphide
		(mg/Nm ³)	(mg/Nm ³)	(mg/Nm ³)	(mg/Nm ³)
		Min.–max.	Min.–max.	Min.–max.	Min.–max.
Dry milling, crushing, grinding, loading	Bag filter	< 1–5	-	-	
Wet milling	Activated carbon filter	-	-	< 0.1	< 0.1
Hot leaching	Afterburner with or without bag filter	1–9	1–9	< 1	< 1–1.7
Ammonia treatment, storage	Wet (H ₂ SO ₄) scrubber	5–7	1–9	< 1	< 1

Source: [296, EAA, OEA 2012]

4.2.5.2 Water and solid waste

In the case of full recycling, the process is waste-water-free. Washing water and condensates of the intermediate process stages are normally returned to the dissolvers to replace the water evaporated in the process and lost in the form of wet oxides as process outputs. Waste water is generated in the partial recycling process.

In the full recycling process, the only solid waste occurring is activated carbon when it is used in the wet milling process.

In some partial recycling processes, the leaching residues are used to cover a tailings pile or are deposited on land [361, Spain 2013]. Salt is leached from the tailings.

4.2.5.3 Energy use

The energy consumption, including both fuel and electricity, for the full recycling process ranges from 1900 MJ to 3845 MJ per tonne of salt slag processed.

One partial recycling process has an average total energy consumption of 81 MJ per tonne of salt slag treated. Partial recycling uses relatively small amounts of energy, as the process recovers just one substance instead of all three products in the salt slag.

When only aluminium and other metallic products are recovered, the energetic cost can be estimated as 0.120 g of CO₂ per kg of salt slag treated.

4.3 Techniques to consider in the determination of BAT

The sections of this document entitled 'Techniques to consider in the determination of BAT' set out techniques generally considered to have the potential for achieving a high level of environmental protection in the industries within the scope of the document. The background to the way the techniques are described is given in Section 2.12 and Table 2.10.

This section presents a number of techniques for the prevention or reduction of emissions and residues as well as techniques for reducing the overall energy consumption. They are all commercially available. Examples are given in order to demonstrate techniques which illustrate a good environmental performance. The techniques that are given as examples are based on information provided by the industry, European Member States and the evaluation of the European IPPC Bureau. The general techniques described in Chapter 2 on common processes apply to a great extent to the processes in this sector and influence the manner in which the main and associated processes are controlled and operated.

4.3.1 Alumina

4.3.1.1 Techniques to reduce dust emissions from the storage, handling, and transport of bauxite and alumina

General techniques applied to reduce diffuse emissions from the storage, handling and transport of raw materials for alumina production are considered in Chapter 2 (see Section 2.12.4.1) and in the Emissions from Storage BREF [290, COM 2006]

Description

The techniques to consider are:

- ESP (see Section 2.12.5.1.1);
- bag filter (see Section 2.12.5.1.4).

Technical description

The dust generated by some milling and separation, and packaging and transport operations may be collected and abated. Bag filters (see Section 2.12.5.1.4) are normally used for operations occurring at ambient temperature. Bag filters can achieve better dust removal efficiencies than ESPs at this stage.

Achieved environmental benefits

- Reduction of emissions to air.
- Recovery of materials.

Cross-media effects

Increase in energy use.

Environmental performance and operational data

Dust emissions from 10 mg/Nm³ to 70 mg/Nm³ have been reported.

Technical considerations relevant to applicability

Bag filter use is limited by the temperature and humidity of the gas.

Economics

No information provided.

Driving force for implementation

- Reduction of dust emissions.

- Recovery of material for reuse.

Example plants

Plants in EL, FR, ES, DE, RO and IE.

Reference literature

[290, COM 2006]

4.3.1.2 Techniques to reduce emissions from drying furnaces, boilers and calcination furnaces for alumina production

Though rarely done, drying of the bauxite, if needed, is performed at the mine site and is therefore outside the scope of this document. Boilers above 50 MW_{th} are covered in the Large Combustion Plant BREF and will not be addressed here. Only techniques to reduce emissions from calcination furnaces are considered.

Description

The techniques to consider are:

- ESP (see Section 2.12.5.1.1) or bag filter (see Section 2.12.5.1.4);
- selection of low-sulphur fuels or natural gas where available;
- low-NO_x burners.

Technical description

Whatever calcination technology is used, fine alumina dust is normally collected by an ESP, though some kilns can now use bag filters depending on the exhaust gas temperatures.

SO₂ emissions are directly related to the sulphur content of the fuel used. Natural gas usually results in quite low SO₂ emissions due to its low sulphur content. However, it must be taken into consideration that the sulphur content in natural gas, although low, may vary significantly depending on where it is extracted and distributed.

NO_x is also formed during the combustion process. NO_x is highly dependent on the type of fuel used, the design of the burner, the combustion chamber and temperature. Higher levels of NO_x have been observed in the production of speciality aluminas that require higher operating temperatures.

Achieved environmental benefits

Reduction of emissions to air.

Cross-media effects

- Increase in energy consumption.
- Waste generation.

Environmental performance and operational data

Emission values from alumina calcining plants are shown in Table 4.31.

Table 4.31: Emissions from alumina calcining plants

Plant	Abatement technique	Value	Flow	Method to obtain data and monitoring frequency	Dust		NO _x	
			Nm ³ /h		mg/Nm ³	kg/t	mg/Nm ³	kg/t
E (fuel used is bunker fuel)	ESP	Min.	151 384	Periodic monitoring	10.00	0.01	123.00	0.14
		Max.	245 288		145.00	0.19	236.00	0.20
		Avg.	219 133		68.00	0.10	157.00	0.18
B	ESP	Min.	NR	NR	7.00	0.0006	186.55	0.03
		Max.	300 000		76.00	0.01	1519.05	0.30
		Avg.	NR		23.00	0.002	536.25	0.09
D	Bag filter	Min.	106 900 (calculated)	Continuous monitoring (monthly average)	19.09	0.07	23.661	0.10
		Max.			29.97		44.85	
		Avg.			23.23		35.75	
D	Bag filter	Min.	92 608 (calculated)	Continuous monitoring (yearly average)	10.53	0.05	0	0.33
		Max.			29.97		272.6	
		Avg.			22.89		118.83	

NB: NR = Not reported.
Source: [378, Industrial NGOs 2012]

Another plant (Plant A) also reported dust data from continuous measurement of its three calciners. Data from Plant A are not shown because they include data related to the start-up and shutdown of the calciners (i.e. including other than normal operating conditions).

Regarding dust, the type of fuel used, as well as the product manufactured, may significantly impact the abatement performance.

Upper range values for NO_x are observed in calcination processes involving the production of speciality aluminas, where higher calcination levels are required.

Technical considerations relevant to applicability

Use of clean fuels and high-performance burners together with ESP technologies are common techniques in calciners. However, configurations depend on the design, which is also affected by the product being manufactured (SGA, speciality aluminas, etc.).

The use of bag filters is limited by the exhaust gas temperature and humidity.

Economics

No information provided.

Driving force for implementation

Reduction of environmental impact.

Example plants

Plants in ES, FR, DE, EL, IE and RO.

Reference literature

[386, EAA 2012]

4.3.1.3 Techniques to prevent and minimise bauxite residue from alumina production

The waste generation associated with the extraction of alumina from bauxite is a key environmental issue; the techniques used to prevent and minimise bauxite residues from alumina production must therefore be considered. The following techniques are consistent with and complementary to those on bauxite residue generation and handling in the Management of Tailings and Waste-rock in Mining Activities BREF.

Description

The techniques to consider are:

- compacting;
- reducing/neutralising the alkalinity remaining in the bauxite residue.

Technical description

It is generally accepted that the best approach with bauxite residues is to either reduce the pH and/or the moisture content as much as possible. Alumina refineries should aim to minimise the alkalinity of the residue disposed of and maximise the solids content. This involves careful design and construction of the dam/dyke walls, and disposal of the material in a way that aids remediation/rehabilitation/revegetation/reuse so that the sites used for bauxite residue storage can ultimately be returned to natural or useful areas.

Bauxite residue can be filtered (at high or low pressure), to form a semi-dry cake; if necessary, water or steam can be used to reduce the alkalinity before transportation, storage or use.

When dried, bauxite residue can lead to a dust emission problem. In the medium/long term, the plan is to cap/restore the sites and encourage vegetative growth on the surface. In the shorter term, dust suppression is alleviated by water sprays.

Some notable successes have been obtained in using bauxite residue in road construction, cement manufacture, capping materials, and refractory replacement; however, only a very small proportion of the bauxite residues produced is currently used.

It is also possible to use the alkalinity of bauxite residue to absorb CO₂, and this is possible where the bauxite production takes place on the same site as or close to a primary aluminium smelter or close to another significant source of CO₂, for example in ammonia production as practised in Australia.

Further details are reported in the BREF on the Management of Tailings and Waste-rock in Mining Activities [332, COM 2009].

Achieved environmental benefits

Minimisation of bauxite residue storage.

Cross-media effects

No information provided.

Environmental performance and operational data

Plate and frame filters have been adopted by plants in Greece and France, and bauxite residues with a solids content of > 70 % can be achieved with these techniques.

Considerable water reduction can also be obtained by 'farming' the muds and, after suitable treatment and periods, solids contents above 50 % are possible.

Technical considerations relevant to applicability

Factors such as the age and technology of the plant, land availability, proximity to the sea, presence of local features such as old mines, climate, logistics, nature of the residue, and regulations all play a part in what can be achieved.

Some of the solutions described in this document are applicable in very limited cases as the specific characteristics of each plant and the area where it is located are different. For example, some plants have limitations on the maximum solids content, as transportation of the bauxite residue to the disposal area must be done with pumping systems.

Use of alkalinity remaining in the bauxite residue

The use of bauxite residues to absorb CO₂ is still under development and its application from a technical and economic point of view is still under study.

Economics

As an example, at one site in France requiring a total of over 400 000 t/yr of bauxite residue dewatering, a first investment allowing the processing of 130 000 t/yr through a press filter cost over EUR 8 million. In order to reach full capacity in the near future, the investment needed will be more than triple this figure.

Driving force for implementation

Reduction of environmental impact.

Example plants

Plants in Spain and Ireland use rotary vacuum mud filters. A plant in France will stop disposal at sea by 2016 and then use filter presses.

Reference literature

[247, France 2008], [332, COM 2009], [387, EAA 2013].

4.3.1.4 Techniques to reduce energy consumption for the production of alumina from bauxite**Description**

The techniques to consider are:

- plate heat exchangers;
- circulating fluidised bed calciners;
- digestion design;
- selection of the bauxite.

Technical description*Plate heat exchangers*

The amount of heat recovered from the liquor flowing to the precipitation area is increased by using plate heat exchangers rather than a flash cooling plant.

Circulating fluidised bed calciners

Circulating fluidised bed calciners have a much higher energy efficiency than rotary kilns, since the heat recovery from the alumina and the flue-gas is greater.

In order to improve energy use, the design of rotary kilns can be adapted by modification of the burner design or position in the kiln and hot waste gases can be used to preheat the feed hydrate. The specific energy consumption of a fluidised bed calciner at Alunorte has been reduced to 2790 kJ/kg of alumina.

Digestion design

By using a single stream, the slurry is heated up in one circuit without using live steam and therefore heating up to the digestion temperature is achieved without dilution of the slurry, as occurs in the double-stream digestion design. A tube digester is one example of an available single-stream digestion design technique.

Selection of the bauxite

The bauxite ore quality has an influence on the energy consumption. Bauxite with a higher moisture content carries more water into the process which needs to be evaporated. In addition, bauxites with high monohydrate contents (boehmite and/or diasporite) require higher pressure and temperature in the digestion process, leading to a higher energy consumption. Bauxite classification is mainly related to the percentage content of available alumina and the kind of alumina present in the bauxite (gibbsite, boehmite, diasporite).

Gibbsite is the easiest to recover from bauxite and can be done at a relatively low temperature (150 °C). In order to recover the alumina when the boehmite content is higher than 4 %, the refinery has to increase the temperature to 250 °C to dissolve the boehmite in the caustic solution (high-temperature or -pressure refinery). Diasporite requires an even higher digestion temperature. Some bauxite ores containing both boehmite and gibbsite can be treated with a double-stream digestion design that does not require full digestion at a high temperature to dissolve the small amount of boehmite contained.

Bauxite with a higher alumina content minimises the energy involved in transportation and handling and less bauxite residue is produced.

A high silica content in the bauxite leads to a higher loss of caustic soda due to the reaction of the silica, resulting in the production of sodium aluminium silicate (sodalite) and the loss of sodium and aluminium, causing dilution of the liquor. This reduces energy efficiency.

Achieved environmental benefits

- Reduction in energy use in digestion.
- Reduction of main emissions to all media.

Cross-media effects

No information provided.

Environmental performance and operational data

By optimising the process, the specific energy consumption can be reduced to below 7.0 GJ/t of Al₂O₃ when using tube digesters.

For other plants with traditional digestion, technology-specific energy consumption can be reduced to below 10 GJ/t of Al₂O₃.

Technical considerations relevant to applicability

Plate heat exchangers

This technology may be appropriate when the energy from the cooling fluid can be reused in the process if the condensate balance and the liquor conditions allow it.

Circulating fluidised bed calciners

Not applicable to speciality/non-smelter-grade aluminas, as the higher calcination levels required can only be achieved in a rotary kiln. Recent research [[388, Finland 2013](#)] points out that circulating fluidised bed calciners could generate particle breakage levels only slightly above the benchmark for particle breakage in rotary kilns.

The design of rotary kilns can be adapted by modification of the burner design or position in the kiln and by the use of hot waste gases to preheat the feed hydrate.

Digestion design

Plants with a double-stream digestion design using steam injection cannot be converted to a single-stream digestion design without the total redesign and rebuilding of the plant; in many cases, there will be insufficient land available.

Selection of the bauxite

Some plants are designed for a specific quality of bauxite, which limits the use of alternative sources. This is the case for plants that are designed for high-temperature and -pressure operation and that are inherently less energy-efficient (e.g. plants using high boehmite and total available alumina content).

Economics*Circulating fluidised bed calciners*

A reduction in fuel consumption of 30–35 % is estimated to be achieved by switching from conventional rotary kilns to fluidised bed calciners. This figure is estimated to be half that if the optimum burner design, burner positioning and hydrate preheating systems are adopted for rotary kilns.

Digestion design

Tube digestion is virtually impossible to consider for existing plants for both cost and space reasons. It should also be noted that the installation of tube digesters in some plants has caused a scale problem which obviates a large proportion of the savings. According to the information provided by the TWG, only two plants use it worldwide (one of which is in Germany).

Driving force for implementation

- Reduction of energy costs.
- Reduction of environmental impact.

Example plants

- Fluidised bed calciners: Plants in Spain and Ireland.
- Rotary kilns: Plants in France and Greece.
- Static calciners: Plants in Greece and Romania.
- Tube digesters: A plant in Germany.
- Speciality alumina plants: Plants in France and Hungary.

Reference literature

[386, EAA 2012], [389, EAA 2012]

4.3.2 Anodes for aluminium production**4.3.2.1 Techniques to reduce emissions from the storage, handling and transport of primary and secondary raw materials**

General techniques applied to reduce diffuse emissions from the storage, handling and transport of primary raw materials for anode production are considered in Chapter 2 (see Section 2.12.4.1) and in the Emissions from Storage BREF [290, COM 2006]. Techniques related to the storage and handling of coke and pitch are considered sector-specific.

Description

The techniques to consider are:

- bag filter (see Section 2.12.5.1.4) or cyclone followed by an ESP (see Section 2.12.5.1.1);
- dry scrubber (see Section 2.12.5.2.3), RTO or CTO (see Section 2.12.5.2.1).

Technical description

Bag filter (see Section 2.12.5.1.4) or cyclone followed by an ESP (see Section 2.12.5.1.1)

Dedusting systems are applied during coke storage and handling, crushing, grinding and separation operations. Bag filters are the most commonly applied technique and achieve better dust removal efficiencies than ESPs.

Dry scrubber (see Section 2.12.5.2.3), RTO or CTO (see Section 2.12.5.2.1)

These techniques are applied in a few cases to abate emissions from hot pitch storage. Back-venting of displaced gases is also applied. In the case of dry scrubbers, the scrubbing agent is usually the coke powder.

Achieved environmental benefits

- Reduction of dust emissions.
- Recovery of raw materials.
- Reduction of VOC emissions.

Cross-media effects

- Increase in energy use.
- Increase in noise level.

Environmental performance and operational data

Table 4.32 provided by EAA shows the performance value ranges for the selected techniques.

Table 4.32: Dust emissions range from the handling, storage and transport of raw materials

Source	Abatement type	Pollutant	Concentration range at stacks (mg/Nm ³)
Material handling and storage. Coke and recycled carbon material	Cyclone + ESP	Dust	20–60
	Bag (fabric) filter	Dust	5–20
<i>Source: [378, Industrial NGOs 2012]</i>			

Technical considerations relevant to applicability

Bag filters are generally applicable.

Economics

No information provided.

Driving force for implementation

Reduction of the environmental impact of the plant.

Example plants

- Bag filter or ESP: all European plants apply either bag filters or ESPs.
- Coke dry scrubber: A plant in Spain.
- RTO or CTO: Plants in Norway and Spain.

Reference literature

[296, EAA, OEA 2012]

4.3.2.2 Techniques to reduce dust and PAH emissions from the grinding, mixing and forming stages

Description

The techniques to consider are:

- bag filter (see Section 2.12.5.1.4);
- condensers;
- dry scrubber (see Section 2.12.5.2.3) followed by a bag filter;
- RTO or CTO (see Section 2.12.5.2.1).

Technical description

Only in some cases do abatement techniques applied at this stage of the process also receive gases from the storage area, as normally grinding, mixing and forming operations take place in separate parts of the plant to storage, handling and transportation.

Dry scrubber (see Section 2.12.5.2.3) and bag filter (see Section 2.12.5.1.4)

Dust emitted by coke and recycled products during grinding and preheating can be collected and filtered by bag filters. PAH emitted from the pitch during mixing and forming can be condensed and/or adsorbed on fine coke particles and then filtered by bag filters. Condensation can be achieved by external and/or internal cooling with air and/or water systems, in a conditioning tower. The loaded dust is then recycled into the mixing process, when possible, based on the quality required for paste production.

When solid pitch is still used, fumes from the remelting will be processed in the same way as pitch fumes from the mixing stages.

RTO or CTO (see Section 2.12.5.2.1)

Dust and PAH emitted during mixing and forming can be incinerated in a RTO or a CTO, while some of the heat generated can be used in the process and may contribute to maintain the temperature of the storage and mixing stages.

Achieved environmental benefits

Dry scrubber and bag filter

- Reduction of dust and PAH emissions.
- Reuse of collected dust.

RTO or CTO

- Reduction of dust and PAH emissions.

Environmental performance and operational data

Bag filter and RTO

Table 4.33: Emissions from coke dust removal

Plant	Abatement technique	Value	Flow	Method to obtain data and monitoring frequency	Dust	
			Nm ³ /h		mg/Nm ³	kg/t of anode
1	RTO	Min.	55 559	Periodic monitoring (reference year 2010)	0.06	8.8E-05
		Max.	72 577		0.25	3.82E-04
		Avg.	67 359		0.16	3.23E-04
1	RTO	Min.	55 559	Periodic monitoring (reference years 2008–2010)	0.01	1.7E-05
		Max.	72 577		0.44	5.88E-04
		Avg.	67 359		0.15	3.05E-04 NR
2	Bag filter	Min.	3 000	Periodic monitoring (reference year 2010)	0.80	NR
		Max.	35 000		10	
		Avg.	18 000		3	
3	Bag filter	Avg.	13 212	Periodic monitoring (once a year; reference years 2007–2010)	5.65	0.01
4	Bag filter	Min.	3 924	Periodic monitoring (12 times per year; reference year 2011)	0.30	NR
		Max.	35 532		15.07	
		Avg.	25 200		3.05	
5	Bag filter	Min.	NR	Periodic monitoring	2	NR
		Avg.			16.70	
6	Bag filter	Min.	24 840	Periodic measurement	6.60	NR
		Max.	27 000		20.50	
		Avg.	25 830		10.70	
7	Bag filter	Min.	2 892	Periodic monitoring (10 times per year; reference year 2010)	0.15	5.8E-05
		Max.	4 665		NR	0.037
		Avg.	3 726		20.04	0.008
		Min.	17 997		1.13	0.003
		Max.	22 943		3.35	0.008
		Avg.	21 398		2.11	0.005
		Min.	3 373		0.98	4.15E-04
		Max.	4 799		17.75	0.008
Avg.	4 024	5.61	0.002			

NB: NR = Not reported.

Source: [378, Industrial NGOs 2012]

Dry scrubber and bag filter

European plants commonly operate paste plant scrubbers with a flow capacity between 25 000 Nm³/h and 100 000 Nm³/h, of which approximately 10 000 Nm³/h may be from the hot pitch mixing stages.

Table 4.34: Emissions from pitch scrubbing processes

Plant	Abatement technique	Value	Flow	Method to obtain data and monitoring frequency	Dust	
			Nm ³ /h		mg/Nm ³	kg/t of anode
2	Dry coke scrubber + bag filter	Min.	5 000	Periodic monitoring	0.20	NR
		Max.	35 000		17.00 *	
		Avg.	18 000		3.00	
4	Dry coke scrubber + bag filter	Min.	10 476	Periodic monitoring (reference year 2011)	1.33	NR
		Max.	14 040		10.93	
		Avg.	12 064		4.23	
5	Dry coke scrubber + bag filter	Min.	NR	Periodic monitoring	0.30	NR
		Max.			4.80	
		Avg.			2.00	
6	Dry coke scrubber + bag filter	Min.	6 120	Periodic monitoring (4 times per year)	0.20	NR
		Max.	7 200		1.90	
		Avg.	6 480		0.80	
7	RTO	Min.	9 348	Periodic monitoring (12 times per year; reference year 2010)	0	0
		Max.	12 900		4.11	0.005
		Avg.	11 770		0.98	0.001
8	Dry coke scrubber + bag filter	Min.	20 985	Periodic monitoring (12 times per year; reference year 2010)	4.10	0.006
		Max.	27 421		NR	NR
		Avg.	23 891		11.93	0.015
DE 1	Dry coke scrubber + bag filter	Max.	NR	Continuous monitoring (reference year 2008; 17 293 half-hourly values)	79.69 % of values below 4 mg/Nm ³	
					98.18 % of values below 6 mg/Nm ³ *	

* ELV is 5 mg/Nm³.
 NB: NR = Not reported.,
 Source: [385, Germany 2012], [378, Industrial NGOs 2012]

Also, Plant FR 1 reported an incident when a dust measurement of 9.64 mg/Nm³ was recorded in 2011. After internal investigation, it was concluded that the incident occurred due to a problem in the feeding system.

Only Plants 8, DE 1 and FR 1 reported data on BaP at this stage of the process. The average value, based on periodic measurements, for Plant 8 is 21.67 µg/Nm³ (0.0277 g/t of anode) and the reported values (spot samples) for Plant DE 1 are 0.7–1.4 µg/Nm³; and for Plant FR 1, 1.9 µg/Nm³ (the reported ELV for this plant is 0.5 µg/Nm³).

RTO or CTO

Although Plant 7 reported using a RTO to handle the scrubbing of hot pitch, no data for PAH/BaP were reported.

Cross-media effects

Dry scrubber and bag filter

- Increase in energy use (cooling).

RTO or CTO

- Increase in energy use (RTO/ CTO operation). However, if the RTO is dedicated only to concentrated pitch fumes, it operates mostly in an autothermal mode and its energy consumption is reduced. As more collection points are added to the flow feeding the RTO, more energy is required to operate it.

Technical considerations relevant to applicability

Bag filter

A bag filter as is only applied a stand-alone technique to remove inert coke dust from operations such as coke storage and grinding.

Dry scrubber and bag filter

These techniques are applicable to all areas where pitch fumes and/or dust are emitted in a paste plant.

RTO or CTO

These techniques are applicable to the paste mixing, cooling and forming stages, where higher concentrations of pitch are found.

Economics

Dry scrubber and bag filter

Investment costs for a dry scrubbing unit with a 50 000 m³/h flow capacity are approximately EUR 1.4 million (excluding the collection network, but including the installation cost).

RTO or CTO

Investment costs for a small CTO unit in 2002 were approximately USD 300 000. A similar unit installed in 2006 cost around EUR 600 000.

Yearly operating costs were approximately USD 6 000 (mainly cleaning and catalytic media).

Electrical energy is used for a start-up period of approximately eight hours (50 kWh), but after that period burn-off gases from the CTO are used to keep the system in operation. In addition, electrical energy is used for a fan, to evacuate 1000 m³/hour of gases.

Investment costs for a Norwegian RTO unit, with a flow capacity of 10 000 m³/h were EUR 1.9 million. Yearly maintenance costs are EUR 20 000.

The investment cost for a RTO unit with a flow capacity of 50 000 m³/h would be approximately EUR 4 million. The combination of a RTO for the higher pitch content gas and a dry scrubber unit for the lower concentration for the same total flow rate would cost approximately EUR 3 million (excluding the collection network in both cases, but including the installation cost).

Driving force for implementation

- Reduction of emissions to air.
- Recovery of dust and pitch.

Example plants

- Dry scrubber and bag filter: most European plants.
- RTO or CTO: Plants in Norway and Spain.

Reference literature

[272, AI input 2008],

4.3.2.3 Techniques to reduce emissions from baking in anode production

Description

The techniques to consider are:

- dry scrubber (see Section 2.12.5.2.3) using alumina as the adsorbent agent followed by a bag filter (see Section 2.12.5.1.4);
- wet scrubber (see Sections 2.12.5.1.6 and 2.12.5.2.2);
- RTO (see Section 2.12.5.2.1) with pre- and post-treatment;
- use of raw materials containing a low amount of sulphur.

Technical description

Once collected from the main circular collector of each furnace, fumes from the one or more anode baking furnaces are sent via a network of ducts to a fume treatment centre. The techniques applied depend on the type of plant (combined anode and aluminium production plant or stand-alone anode production plant).

Dry scrubber (see Section 2.12.5.2.3) followed by a bag filter (see Section 2.12.5.1.4)

Dry scrubbing is based on the recovery of fluorides and PAH by adsorption, using alumina as the scrubbing agent. Usually, the gases are cooled in a first stage, using a water cooling tower, in order to reach gas temperatures compatible with a proper fluoride and PAH adsorption. The fresh alumina is then introduced to a reactor stage together with the fumes. Most of the adsorption onto the alumina takes place in this reactor stage. The fumes and alumina mixture then enters a dust removal system, where the charged alumina is separated from the combustion gas. Most commonly, bag filters are used for dust removal. An additional adsorption is achieved in these bag filters due to the filter cake built up on the filters. The charged alumina is used as alumina feed for the electrolysis.

Wet scrubber (see Sections 2.12.5.1.6 and 2.12.5.2.2)

Fluorides, PAH and dust are dissolved and/or separated from the gas stream. Water runs in a closed loop and regular purges are conducted to maintain the required operational conditions.

RTO (see Section 2.12.5.2.1) with pre- and post-treatment

A RTO is the preferred option for anode plants that do not have direct access to alumina (i.e. stand-alone plants) and is also present in other configurations for historical reasons. The process depends on an alternating cycle of gases through a series of support zones where heating, cooling and cleaning cycles take place.

Since such stand-alone anode plants accept recycled anode butts in their feed, provision has to be made for fluoride recovery in a post-treatment phase.

The entire process is a four-step system.

1. Removal of coarse tar components and dust: the exhaust gas from the baking furnace is led through a packed bed of ceramic elements. The heavy tar components condense on the bed, which is cleaned periodically using the hot gases from the RTO. The off-gases from the cleaning phase pass to the RTO and not the pretreatment stage.
2. RTO: ceramic beds are used to preheat the exhaust gas. By switching the direction of the airflow regularly, these ceramic beds are preheated with the gas from the combustion room.
3. Combustion chamber: the off-gases are led to the combustion chamber, where fine tar components and PAH are destroyed at a temperature of approximately 800 °C.
4. Fluoride absorption: the exhaust gases are taken through a bed of crushed lime or limestone to capture fluorides. In one plant in Norway, fluoride capture is done by seawater scrubbing, while in one plant in Germany an alumina dry scrubber is used, followed by a bag filter.

Use of raw materials containing a low amount of sulphur

SO₂ emissions from the baking furnace are highly influenced by the sulphur content of the anodes produced and the fuel used.

Achieved environmental benefits

Dry scrubber followed by a bag filter

- Reduction of dust, PAH and fluoride emissions.
- Full recovery and recycling of all the products that are used as pot feed.
- Use of alumina as the cleaning agent, thus mitigating the need for other reagents or heating fuel.

Wet scrubber

- Reduction of dust and fluoride emissions.

RTO with pre- and post-treatment

- Reduction of dust, PAH and fluoride emissions.

Use of raw materials containing a low amount of sulphur

- Reduction of SO₂ emissions.

Environmental performance and operational data

Most anode baking furnaces have a specific fume emission volume of 3500–7500 m³ per tonne of anode, depending on the technology of the furnace. Modern open furnaces usually have a flow capacity of around 5500 m³ per tonne of anode.

The emission figures may increase with time, as the furnace ages, because of refractory work and collector leaks.

Table 4.35 to Table 4.40 show emissions from baking furnaces integrated with primary aluminium smelters, while Table 4.41 and Table 4.42 show emissions from a stand-alone anode production plant.

Dry scrubber followed by a bag filter

Table 4.35: Emissions from anode baking after abatement with an alumina scrubber and bag filter in Plant E

Abatement technique	Value	Flow (Nm ³ /h)	Method to obtain data and monitoring frequency	Dust (mg/Nm ³)	Fluorides (mg/Nm ³)	SO ₂ (mg/Nm ³)
Dry alumina scrubber + bag filter	Min.	61 200	Periodic monitoring (reference year 2011)	1.30	0.41	99.48
	Max.	79 200		3.85	0.76	151.28 *
	Avg.	71 460		2.21	0.59	124.35
* The sulphur content in the anodes was not reported. Source: [378, Industrial NGOs 2012]						

Table 4.36: Emissions from anode baking after abatement with an alumina scrubber and bag filter in a plant in Germany

Abatement technique	Value	Method to obtain data and monitoring frequency	Dust	BaP	Formaldehyde	Benzene	HF	SO ₂
			mg/Nm ³	µg/Nm ³	mg/Nm ³	mg/Nm ³	mg/Nm ³	mg/Nm ³
Dry alumina scrubber + bag filter	Min.	Continuous monitoring for dust (17 300 half-hourly values in 2008) and periodic monitoring for the other parameters	NR	NR	0.4	0.6	NR	22.9
	Max.		79.09 % of values below 4 mg/Nm ³	< 1.0	2.9	2.4	< 0.2	35.2 *
			90.03 % of values below 6 mg/Nm ³					
		94.65 % of values below 10 mg/Nm ³						

* Fuel containing low sulphur percentages, no sulphur added to the blend.
 NB: NR = not reported.
 Source: [385, Germany 2012]

Table 4.37: Emissions from anode baking after abatement with an alumina scrubber and bag filter in a plant in France

Plant	Abatement technique	Value	Method to obtain data and monitoring frequency	Dust		HF	Fluorides
				mg/Nm ³	kg/t of anode	mg/Nm ³	mg/Nm ³
FR 1	Dry alumina scrubber + bag filter	Min.	Periodic monitoring (twice a year; reference year 2012)	1.36	0.02	0.02	0.03
		Max.		2.56	0.04	0.04	0.07
		Avg.		1.96	0.03	0.03	0.05
FR 1		Min.	Periodic monitoring (3 times per year; reference year 2011) *	1.30	0.02	0.03	0.02
		Max.		4.67	0.06	0.06	0.11
		Avg.		3.10	00.4	0.03	0.06

* This plant reported an incident when measuring a value of 15.4 mg/Nm³. After internal investigation, it was concluded that this value was due to the abnormal deterioration of one of the filters.
Source: [390, France 2012]

Wet scrubber in combination with other techniques

Wet scrubbers are also used with different configurations: together with dry injection cleaning (Plant A) and with an ESP and dry scrubber (Plant F).

Table 4.38: Emissions from anode baking after abatement with a wet scrubber combined with dry injection cleaning in a combined anode and aluminium production plant

Plant	Abatement technique	Value	Flow	Dust		BaP		Fluorides		SO ₂ ⁽¹⁾	
			Nm ³ /h	mg/Nm ³	kg/t of anode	µg/Nm ³	kg/t of anode	mg/Nm ³	g/t of anode	mg/Nm ³	kg/t of anode
A	Wet scrubber combined with dry injection cleaning	Min.	191 130	0.85	1.47E-04	0.001		0.002	3E-08	0.46	8.1E-05
		Max.	254 785	5.06	8.52E-04	0.207		0.08	1.4E-05	2.57	4.91E-04
		Avg.	12 976	1.01	4.70E-04	0.058		0.01	2E-06	1.41	2.67E-04

(¹) Anode sulphur content is 1.4 %.
 Values of 2010.
 Source: [378, Industrial NGOs 2012]

Table 4.39: Emissions from anode baking after abatement with a wet scrubber combined with an ESP and dry scrubber in a combined anode and aluminium production plant

Plant	Abatement technique	Value	Flow	Method to obtain data and monitoring frequency	Dust		BaP		Fluorides		SO ₂	
			Nm ³ /h		mg/Nm ³	kg/t of anode	µg/Nm ³	kg/t of anode	mg/Nm ³	g/t of anode	mg/Nm ³	kg/t of anode
F	Wet scrubber with ESP and dry scrubber	Min.	40 000	Periodic monitoring (9 times per year)	0.80	0.004	0.53	0.002	0.002	2E-05	7.32	0.03
		Max.	44 800		7.16	0.032	87.02	0.026	0.37	0.001	18.14	0.08
		Avg.	42 873		2.79	0.012	13.01	0.011	0.06	4E-04	11.81	0.05

Source: [378, Industrial NGOs 2012]

Data have also been reported from a plant in Norway using a wet scrubber with seawater and a wet ESP in addition to the RTO (Table 4.40).

Table 4.40: Emissions from anode baking after abatement with RTO in combination with a wet scrubber with seawater and ESP

Plant	Abatement technique	Value	Flow	Method to obtain data and monitoring frequency	Dust		BaP		Fluorides		SO ₂	
			Nm ³ /h		mg/Nm ³	kg/t of anode	µg/Nm ³	kg/t of anode	mg/Nm ³	g/t of anode	mg/Nm ³	kg/t of anode
G	RTO in combination with wet scrubber using seawater and ESP	Min.	33 633	Periodic monitoring (21 times per year; reference year 2010)	0.18	0.001	1.00	0.002	0.002	3E-06	1.30	0.003
		Max.	118 184		4.71	0.03	47.00	0.365	0.006	5.3E-5	27.06	0.17
		Avg.	55 582		1.25	0.004	11.00	0.056	0.004	1.3E-05	9.28	0.04

Source: [378, Industrial NGOs 2012]

RTO with pre- and post-treatment

The example given in Table 4.41 and Table 4.42 is for a RTO connected to a baking furnace in the Netherlands (80 000 Nm³/h).

Table 4.41: Emissions from anode baking after abatement with a RTO in a stand-alone anode production plant (part 1)

Plant	Abatement technique	Dust	Fluorides	SO ₂	NO _x	Value	Method to obtain data and monitoring frequency
		mg/Nm ³	mg/Nm ³	mg/Nm ³	mg/Nm ³		
C	RTO	3.5	1.6	250 ⁽¹⁾	61	Avg	Continuous monitoring (half-hourly averages)

⁽¹⁾ Emission levels of 174 mg/Nm³ were reached in previous years, due to lower baking temperatures and the use of raw materials with a low sulphur content.
Source: [391, The Netherlands 2012]

Additional information from this plant, corresponding to the period from January to August 2013, show strong variations in the daily emissions of SO₂ (values ranging from around 100 mg/Nm³ to more than 500 mg/Nm³) and HF (values ranging from less than 0.5 mg/Nm³ to more than 5 mg/Nm³). The reported sulphur content in the anodes was 1.5 % as a yearly average in 2011, 2012 and 2013.

Table 4.42: Emissions from anode baking after abatement with a RTO in a stand-alone anode production plant (part 2)

Plant	Abatement technique	Value	Method to obtain data and monitoring frequency	PAH (EPA)	PAH (EPA)	PAH (OSPAR/NeR)	PAH (OSPAR/NeR)	C _x H _y
				µg/Nm ³	µg/Nm ³	µg/Nm ³	µg/Nm ³	mg/Nm ³
C	RTO	Min.	Periodic monitoring	28	160	2.8	2.6	2.8
		Max.		430	160	13.8	2.6	2.8
		Avg.		180	160	7.8	2.6	2.8

Source: [391, The Netherlands 2012]

Cross-media effects

Dry scrubber followed by a bag filter

- Increase in energy use (dry scrubbing requires an energy consumption of 30–50 kWh/t of anode, fans included).

Wet scrubber

- Increase in energy and water use, when open loops are used.
- Waste generation.
- If seawater scrubbing is used during the post-treatment, the seawater becomes contaminated with fluoride, sulphate salts and PAH/BaP.

RTO with pre- and post-treatment

- Increase in energy use (to maintain temperatures in the combustion zone). The overall site energy consumption is increased by 10 %.
- Increase in CO₂ and NO_x emissions.
- If seawater scrubbing is used during the post-treatment, the seawater becomes contaminated with fluoride and sulphate salts.

Technical considerations relevant to applicability

Dry scrubber followed by a bag filter

These techniques are applicable to most processes where alumina can be used as the scrubbing agent. Since alumina is available in aluminium production plants, these techniques are the most commonly used in combined anode and aluminium production plants.

Wet scrubber

This technique is applicable to new plants. When considering the use of this technique in existing plants, it is necessary to take into account the increase in emissions to water of fluorides, sulphates and tar. Its applicability may be restricted if the waste water treatment plant cannot treat the pollutants present in the scrubber's effluent and the resulting water cannot be recycled to the process or discharged. The applicability may be also limited for very high waste gas flow rates due to the significant amounts of waste and waste water, and in arid areas by the large volume of water necessary.

RTO with pre- and post-treatment

This technique is best applied in stand-alone plants that do not have access to alumina. When installed in existing plants with access to alumina, a RTO is complemented with further dust filtration techniques.

Use of raw materials containing a low amount of sulphur

Generally applicable.

Economics

Dry scrubber followed by a bag filter

On a European basis, the overall investment cost for a turnkey fume treatment centre consisting of a dry scrubber and bag filter, including civil works, would be approximately EUR 10 million for 133 000 t/yr of baked anode.

RTO with pre- and post-treatment

At one site in the Netherlands, the installation in 2003 of a single RTO unit for a single furnace cost EUR 12 million (excluding utilities, infrastructure, etc.). The overall maintenance cost is EUR 300 000 per year, plus gas: EUR 42 000 per year, and electricity: EUR 5 000 per year. Waste disposal (lime residue) costs EUR 22 000 per year. The recent installation of two more units for a total of EUR 47 million (excluding utilities, infrastructure, etc.) will more than triple the operating costs.

Thus, for a similar performance, energy consumption and investments are much higher than the combination of alumina scrubbers and bag filters. Therefore, this technique is not the preferred one for installations with access to alumina, and is best applied in stand-alone anode plants.

Driving force for implementation

Dry scrubber followed by a bag filter

Reduction of dust, PAH and fluoride emissions.

Wet scrubber

Reduction of dust, PAH and fluoride emissions.

RTO with pre- and post-treatment

Reduction of dust, PAH and fluoride emissions.

Example plants

- Dry scrubber followed by a bag filter: Plants in UK, FR, IT, NL, NO, RO and others.
- Dry scrubber followed by a bag filter and wet scrubber: A plant in Norway.
- Wet scrubber: A plant in Spain.
- RTO with pre- and post-treatment: Plants in NL, NO and DE.

Reference literature

[233, COM 2008], [242, Infomil 2008], [286, OSPAR 1998], [312, VDI 2008], [318, Hagen et al. 2007], [348, Solios 2010], [375, Mannweiler et al. 2006]

4.3.3 Primary aluminium

4.3.3.1 Techniques to reduce emissions from the storage, handling and transport of the raw materials used for primary aluminium production

General techniques applied to reduce diffuse emissions from the storage, handling and transport of the raw materials used for primary aluminium production are considered in Chapter 2 (see Section 2.12.4.1) and in the Emissions from Storage BREF [290, COM 2006].

Description

The techniques to consider are:

- bag filter (see Section 2.12.5.1.4);
- ESP (see Section 2.12.5.1.1).

Technical description

Due to the potentially dusty nature of alumina and fluxes, dust may be collected and abated at specific conveyor transfer points and at grinding and separation operations. Bag filters (see Section 2.12.5.1.4) are the most commonly applied technique and achieve better dust removal efficiencies than ESPs (see Section 2.12.5.1.1).

Achieved environmental benefits

- Reduction of emissions to air.
- Recovery of materials.

Cross-media effects

Increase in energy use.

Environmental performance and operational data

No information provided.

Technical considerations relevant to applicability

Generally applicable.

Economics

No information provided.

Driving force for implementation

- Reduction of dust emissions.
- Recovery of material for reuse.

Example plants

All European plants apply either bag filters or ESPs.

Reference literature

[290, COM 2006].

4.3.3.2 Techniques to reduce the emissions of perfluorocarbons from primary aluminium production

Description

The techniques to consider are point feed prebaked cells (PFPB) and point feed vertical stud Söderberg cells (PFVSS), in conjunction with the following features:

- automatic multiple point feeding of alumina;
- computer control of the electrolytic process based on active cell databases and monitoring of cell operating parameters;
- automatic anode effect suppression.

Technical description

PFPB and PFVSS are described in Section 4.1.2.

Achieved environmental benefits

- Reduction of the anode effect rate and minimisation of the effect duration.
- Reduction of total CO₂ and PFC emissions.
- Reduction of energy use.
- Optimisation of process parameters such as pot stability, leading to a better overall process efficiency.
- Additional reduction in the dust and fluoride emissions to the pot room, as hoods are opened less frequently.

Cross-media effects

No information provided.

Environmental performance and operational data

Expected emissions are reported in Section 4.2. A benchmark for CO_{2eq} emissions in primary aluminium production already exists under the ETS scheme, including for PFC emissions.

Technical considerations relevant to applicability

The automatic anode effect suppression is not applicable to Söderberg cells, since Söderberg anode design (one only piece) does not allow the bath flow associated with this operation. In the prebaked cell, a way to suppress the anode effect automatically is to reduce the height of the anode plane. When this happens, there is more anode inside the bath and the bath flows at an

elevated position in the cell. In the Søderberg pots, due to their design, the bath cannot flow, so they are not able to cope with such elevation of the molten bath/fluids of the pot which therefore makes this technique unviable.

Economics

No information provided.

Driving force for implementation

- Energy savings and process performance improvement.
- Reduction of CO_{2eq} and, to a lesser extent, dust and fluoride emissions.

Example plants

All European smelters.

Reference literature

[233, COM 2008], [286, OSPAR 1998], [312, VDI 2008]

4.3.3.3 Techniques to prevent or collect diffuse emissions from both the cells and the pot room in primary aluminium production using Søderberg technology

Description

The techniques to consider are:

- use of paste with a lower pitch content (dry paste), ranging from 25 % to 28 %;
- upgraded manifold design to allow closed point feeding operations and improved gas collection efficiency, followed by a dry scrubber treatment for the electrolytic gases using alumina as the adsorbent agent;
- alumina point feeding;
- increased anode height to lower the anode top temperature;
- anode top hooding followed by dry scrubber treatment;
- improved burner for incineration of PAH and other hydrocarbons.

Technical description

There are features in the design of the new Søderberg technology that are common to all the plants (e.g. the use of paste with a lower pitch content, dry alumina scrubber for electrolytic gases, improved burner and point feeding of alumina), and others that are specifically based on the former design of the cells (e.g. anode top hooding followed by dry scrubber treatment when high current density anodes are used, or increased anode height when low current density anodes are operated).

All plants operating Søderberg cells in Europe have been retrofitted with new Søderberg technology. The development of new Søderberg installations is not expected and the existing plants still in operation should incorporate an adequate combination of the systems listed above.

The alumina scrubbers are used to treat pot gases (see Section 4.3.3.5). When anode top hooding is used, the related gases are treated through additional separate scrubbers.

Achieved environmental benefits

- Reduction in total emissions (fluorides, dust and PAH).
- Reduction in energy use.
- Full recovery of fluorinated products, which are then returned to the pots.
- Use of the raw material (alumina) as the cleaning agent, thus mitigating the need for reagents.
- Improvement of working conditions for potline operators.

Cross-media effects

No information provided.

Environmental performance and operational data

Emissions from Söderberg cells are reported in Sections 4.3.3.5 and 4.3.3.8.

Technical considerations relevant to applicability

For pots with a high current density, complete hood coverage of the anode top, which is connected to a separate gas exhaust and dry scrubber using alumina, has proven to be the best solution.

An increased anode height, which allows the creation of a solid barrier at the top of the anode that serves as a filter for PAH emissions, is generally applicable. This solution provides equivalent results to anode hooding.

Economics

Economic data vary significantly from one plant to another depending on the former design and other engineering constraints. The latest projects in Europe had costs ranging from USD 250/t to USD 600/t. Investment costs may be affected by other factors such as complementary equipment and utilities which may involve additional costs.

Driving force for implementation

- Reduction of environmental impact.
- Reduction of energy costs.

Example plants

- Point feeding of alumina, dry paste, anode height increase, alumina scrubber followed by bag filter and burner: A plant in Spain (low current density anodes).
- Point feeding of alumina, dry paste, anode height increase, alumina scrubber followed by bag filter for anode top hooding, wet scrubber with seawater and burner: A plant in Norway (high current density anodes).

Reference literature

[296, EAA, OEA 2012].

4.3.3.4 Techniques to prevent or collect diffuse emissions from electrolytic cells in primary aluminium production using prebaked anodes

Description

The techniques to consider are PFPB (described in Section 4.1.3) in conjunction with the following features.

- Automatic multiple point feeding of alumina.
- Complete hood coverage of the cell and the use of robust cell hoods and adequate extraction rates taking into account fluoride evolution from the bath and carbon anode consumption. Where installed, the boosted suction system can be connected to a separate gas exhaust and a filter system.
- Minimisation of the time for changing anodes and other actions that require the removal of cell hoods.
- Storage of removed anodes in a compartment near the cell where air is extracted and led to the gas treatment centre.
- Efficient process control system to stop process upsets leading to an increased cell evolution and emissions.
- Use of a programmed system for cell operations and maintenance.

- The use of established efficient cleaning methods in the rodding plant to recover fluorides and carbon; the collection of gas and dust from the cleaning process.

Technical description

PFPB are described within Section 4.1.3.

Achieved environmental benefits

- Reduction of total emissions.
- Improvement of working conditions for potline operators.

Environmental performance and operational data

On a yearly average basis, hooding efficiencies of between 95 % and 98.5 % can be achieved by constant suction systems or above 99 % when boosted suction systems are required by local conditions, as described in Section 4.2.

The quantity of air and gas being sucked from the pots and directed to the gas treatment centre (GTC) versus what actually goes to the roof vents by natural convection can be summarised through various examples, though roof vent flows are measured with a lower accuracy than stack flows. Some example figures are given in Table 4.43.

Table 4.43: Off-gas collected for treatment and ventilation airflow in several European primary aluminium plants

Example plant in:	Collected gas for treatment (Nm ³ /t Al)	Airflow through roof vents ⁽¹⁾ (Nm ³ /t Al)
France	80 000	1 140 000
Germany	80 000–120 000	700 000–1 400 000
Netherlands	110 000	880 000–1 520 000
Iceland	75 000–100 000	500 000–1 500 000
Spain (prebake)	90 000–120 000	250 000–400 000 ⁽²⁾
Slovenia	84 000–110 000	900 000–1 200 000
Spain (Søderberg) ⁽³⁾	20 000–30 000	No data available

⁽¹⁾ Airflow through roof vents is highly affected by meteorological conditions.
⁽²⁾ Forced roof ventilation: the use of forced roof ventilation usually shows lower specific flows which are adjusted to meet the ventilation needs and to optimise the energy used.
⁽³⁾ Søderberg plants usually have lower flows in the gas collected for treatment in order to ensure the optimum operation of the burners.
Source: EAA, 2012

When boosted suction systems (BSS) are required, the base suction flow rate (collected gas for treatment) is multiplied by up to 1.5 to 3 during operation on the specific cell being dealt with (anode change, tapping or others).

Cross-media effects

- Increase in energy use (for suction of the gas). This is accounted for in the total energy demand of the gas treatment centre, reported in Section 4.3.3.5 below.
- Noise around fans is relevant and must be mitigated so as not to cause nuisance.

Technical considerations relevant to applicability

These techniques are applicable to most processes, depending on the installation.

A BSS is only applicable to new plants, as it is best considered during the initial design of the plant, and the decision to install a BSS will be taken in compliance with local requirements, or depending on particular climate or topography sensitivities.

A BSS is not an option for potlines fitted with single hoods on each side, as it has no effect while these are fully open.

The storage of removed anodes in a compartment with air extraction near the cells is only applicable for new plants, due to space limitations in existing plants.

Economics

The cost of systems to collect gas from pots are included in the total abatement cost presented in Section 4.3.3.5.

Driving force for implementation

Reduction of the environmental impact.

Example plants

- Constant suction system: most European plants.
- BSS: Plants in NO, IS and SK.

Reference literature

[233, COM 2008], [312, VDI 2008]

4.3.3.5 Techniques to reduce dust and fluorides from cell gases

Description

The techniques to consider are:

- dry scrubber (see Section 2.12.5.2.3) using alumina as an adsorbent agent followed by a bag filter (see Section 2.12.5.1.4);
- additionally, a wet scrubber (see Section 2.12.5.2.2) can also be used.

Technical description

Collected gases from the electrolytic cells are sent via a network of ducts to one or more gas treatment centres (GTCs), which are composed of a dry scrubber and a bag filter. Dry scrubbing is based on the recovery of fluorides by adsorption onto alumina used as the scrubbing agent. The fresh alumina is introduced to a reactor stage together with the process gas from the electrolysis. Most of the adsorption of the gaseous fluorides on the alumina takes place in this reactor stage. The gas and alumina mixture then enters a dust removal system where the alumina enriched with fluoride is separated from the process gas. Most commonly, bag filters are used for dust removal. An additional adsorption is achieved in these bag filters due to the filter cake that is built up on them. The alumina removed from the process gas is used as alumina feed for the electrolysis (so-called secondary or fluorinated alumina).

Achieved environmental benefits

- Reduction of total fluorides and dust emissions.
- Reduction of PAH when Söderberg cells are connected to GTCs.
- Full recovery of fluorinated products which are returned to the pots.
- Lower consumption of aluminium fluorides.
- Use of the raw material (alumina) as the cleaning agent, thus mitigating the need for reagents.

Environmental performance and operational data

Plant-specific emissions were reported both for emissions leaving the GTC (stack emissions) and for total emissions (stack emissions and roof emissions). Stack emissions are shown in Table 4.44 to Table 4.53, while total emissions are shown in Table 4.54 and Table 4.55.

Stack emissions (mass loads) of dust, HF and total fluorides from European primary aluminium plants using prebaked cells and alumina scrubbers followed by bag filters can be found in Table 4.44.

Table 4.44: Dust, HF and total fluoride stack emissions (mass loads) from PFPB plants using alumina scrubbers and bag filters

Abatement technique	Plant	Value	Flow (Nm ³ /h)	Flow (Nm ³ /t Al)	Dust (kg/t Al)	HF (kg/t Al)	Total fluorides (kg/t Al)	Monitoring frequency	Average	
Alumina scrubber + bag filter	1	Minimum	1 992 965	NR	0.273	0.024	0.063	Continuous	Monthly	
		Average	2 058 291	94 595	0.377	0.045	0.094			
		Maximum	2 114 101	NR	0.451	0.073	0.127			
	1	Minimum	2 014 707	NR	0.377	0.04	0.094	Continuous	Yearly	
		Average	2 062 179	94 595	0.490	0.06	0.127			
		Maximum	2 157 600	NR	0.535	0.09	0.155			
	2	Minimum	849 672	NR	0.0196	NR	0.01	Periodic (once a month, 24-hour sampling)	Over the sampling period	
		Average	939 096	79 364	0.0658		0.036			
		Maximum	1 008 000	NR	0.1496		0.112			
	2	Minimum	876 335	NR	NR	0.048	NR	0.029	Periodic (once a month, 24-hour sampling)	Average of the samples obtained during one year
		Average	920 347			0.057		0.034		
		Maximum	939 096			0.066		0.038		
	3	Minimum	NR	NR	NR	0.050	NR	0.020	Periodic (approx. once a month)	Over the sampling period
		Average			88 151	0.120		0.037		
		Maximum			NR	0.200		0.048		
	5 ⁽¹⁾	Minimum	NR	NR	NR	0.027	0.009	0.01	Periodic (four times a year)	Average of the samples obtained during one year
		Average	2 825 000	80 000	NR	0.035	0.028	0.032		
		Maximum	NR	NR	NR	0.051	0.05	0.09		
	6	Minimum	NR	NR	NR	0.470	0.030	0.070	Periodic (four times a year)	Average of the samples obtained during one year
		Average	3 000 000	110 000	NR	0.670	0.050	0.090		
		Maximum	NR	NR	NR	0.900	0.170	0.180		
	7	Minimum	828 000	NR	NR	0.280	0.013	0.030	Periodic (once a month)	Average of the samples obtained during one year
		Average	1 228 300	86 000	NR	0.320	0.020	0.050		
		Maximum	1 656 000	NR	NR	0.330	0.030	0.080		
	8	Minimum	NR	NR	NR	0.080	0.010	0.020	Periodic (twice a month)	Average of the samples obtained during one year
		Average	1 114 800	82 229	NR	0.150	0.038	0.030		
		Maximum	1 260 000	NR	NR	0.330	0.060	0.060		
9	Minimum	878 471	NR	NR	0.050	0.040	NR	Continuous	Yearly	
	Average	1 413 529			0.090	0.060				
	Maximum	1 604 478			0.170	0.070				

(¹) Plant using a BSS.
 NB: NR = Not reported.
 Source: [378, Industrial NGOs 2012]

A more detailed illustration of dust stack emissions (concentrations) from a PFPB plant using an alumina scrubber and bag filter can be seen in Table 4.45, Table 4.46 and Table 4.47. Measurements are carried out once a month.

Table 4.45: Dust stack emissions (concentrations) from a PFPB plant during 2013

Abatement technique	Plant	Value (dust) in mg/Nm ³	January	February	March	April	May	June	July
Alumina scrubber + bag filter	FR 1	Average over the sampling period (one measurement per month, 24-hour sampling)	1.73	0.89	1.42	2.44	1.37	1.27	1.53

Source: [390, France 2012]

Table 4.46: Dust stack emissions (concentrations) from a PFPB plant during 2012

Abatement technique	Plant	Value (dust) in mg/Nm ³	January	February	March	April	May	June	July	August	September	October	November	December	Yearly average
Alumina scrubber + bag filter	FR 1	Average over the sampling period (one measurement per month, 24-hour sampling)	1.90	0.04	1.10	0.69	1.35	2.90	1.55	0.71	1.92	0.88	0.99	1.46	1.29

Source: [390, France 2012]

Table 4.47: Dust stack emissions (concentrations) from a PFPB plant during 2011

Abatement technique	Plant	Value (dust) in mg/Nm ³	January	February	March	April	May	June	July	August	September	October	November	December	Yearly average
Alumina scrubber + bag filter	FR 1	Average over the sampling period (one measurement per month, 24-hour sampling)	1.02	0.47	0.28	0.53	0.68	0.70	0.77	0.95	0.71	0.67	0.81	3.00	0.88

Source: [390, France 2012]

Also, Plant UK 1 provided more detailed information about its emissions. Measurements are done quarterly, and data are shown in Table 4.48.

Table 4.48: Dust stack emissions (mass loads) from Plant UK 1 during 2012

Abatement technique	Plant	Value		Dust (kg/t Al)	HF (kg/t Al)	Ft (kg/t Al)
Alumina scrubber + bag filter	UK 1	Average over the sampling period (quarterly measurement)	First quarter	0.282	0.107	0.211
			Second quarter	0.379	0.153	0.169
			Third quarter	0.439	0.023	0.04
			Fourth quarter	0.169	0.021	0.024
<i>Source:</i> [392, UK 2013]						

The suction rate in the cells reported for Plant UK 1 ranges from 80 000 Nm³/t Al to 90 000 Nm³/t Al.

In the case of German PFPB plants, using alumina scrubbers and bag filters, the information provided on dust and HF stack emissions is included in Table 4.49 and Table 4.50.

Table 4.49: Dust stack emissions (concentrations) from German PFPB plants using alumina scrubbers and bag filters

Abatement technique	Plant	Dust (mg/Nm ³)	Monitoring frequency	Average
Alumina scrubber + bag filter	DE 1 (reference year 2008)	98.64 % of values below 6	Continuous	Half-hourly (17 313 values)
		99.92 % of values below 9		
	DE 2 (reference year 2008)	0.52 % of values below 1	Continuous	Half-hourly (17 529 values)
		98.8 % of values below 3		
		99.95 % of values below 5		
	<i>Source:</i> [385, Germany 2012]			

Table 4.50: HF stack emissions (concentrations) from German PFPB plants using alumina scrubbers and bag filters

Abatement technique	Plant	HF (mg/Nm ³)	Monitoring frequency	Average
Alumina scrubber + bag filter	DE 1 (reference year 2008)	32.86 % of values below 0.6	Continuous	Half-hourly (17 281 values)
		94.04 % of values below 1.05		
		98.45 % of values below 1.2		
	DE 2 (reference year 2008)	5.16 % of values below 0.5	Continuous	Half-hourly (17 494 values)
		88.44 % of values below 1		
		98.76 % of values below 1.1		
<i>Source:</i> [390, France 2012]				

There are PFPB plants that, in addition to the abatement techniques usually applied (alumina scrubber and bag filter), also use a wet scrubber. Stack emissions from these plants can be found in Table 4.51.

Table 4.51: Dust, HF and total fluoride stack emissions (mass loads) from PFPB plants using alumina scrubbers, bag filters and wet scrubbers

Abatement technique	Plant	Value	Flow (Nm ³ /h)	Dust (kg/t Al)	HF (kg/t Al)	Total fluorides (kg/t Al)	Monitoring frequency	Average
Alumina scrubber + bag filter + wet scrubber	A	Minimum	212 151	0.00001	0.0002	0.001	Periodic (once a month)	Average over the sampling period
		Average	277 391	0.0347	0.0118	0.013		
		Maximum	305 933	0.1555	0.0502	0.052		
	A	Minimum	260 362	0.003	0.0001	0.0005	Periodic (once a month)	Average of the samples obtained during one year
		Average	272 228	0.047	0.046	0.026		
		Maximum	278 931	0.286	0.073	0.109		
	B	Minimum	123 287	NR	NR	NR	Periodic (twice a month)	Average of the samples obtained during one year
		Average	158 473	0.098	0.055	0.060		
		Maximum	202 761	NR	NR	NR		
	C	Minimum	241 963	0.022	0.006	0.006	Periodic (twice a month)	Average of the samples obtained during one year
		Average	284 575	0.048	0.015	0.016		
		Maximum	326 893	0.106	0.052	0.052		
NB: NR = Not reported.								
Source: [378, Industrial NGOs 2012]								

Regarding primary aluminium plants using Söderberg cells, there are three plants in Europe: two of which use an alumina scrubber and bag filter, and the third additionally using a wet scrubber.

Stack emissions (mass loads) of dust, HF and total fluorides from European primary aluminium plants using Söderberg cells and alumina scrubbers followed by bag filters can be found in Table 4.52.

Table 4.52: Dust, HF and total fluoride stack emissions (mass loads) from Søderberg plants using alumina scrubbers and bag filters

Abatement technique	Plant	Value	Flow (Nm ³ /t Al)	Dust (kg/t Al)	HF (kg/t Al)	Total fluorides (kg/t Al)
Alumina scrubber + bag filter	D	Minimum	20 000	0.090	NR	0.003
		Average	NR	0.360	NR	0.021
		Maximum	30 000	1.070	NR	0.330
	E	Minimum	20 000	0.013	0.04	0.007
		Average	NR	0.063	0.06	0.060
		Maximum	30 000	0.190	0.09	0.194
NB: NR = Not reported. Source: [378, Industrial NGOs 2012]						

Stack emissions (mass loads) of dust, HF and total fluorides from the only European primary aluminium plant using Søderberg cells and a wet scrubber, in addition to the alumina scrubber and bag filter typically used, can be found in Table 4.53.

Table 4.53: Dust, HF and total fluoride stack emissions (mass loads) from the Søderberg plant using an alumina scrubber, bag filter and wet scrubber

Abatement	Plant	Value	Flow (Nm ³ /h)	Dust (kg/t Al)	HF (kg/t Al)	Monitoring frequency	Average
Alumina scrubber + bag filter + wet scrubber	F	Minimum	100 000	0.003	0.0003	Periodic (once a month)	Over the sampling period
		Average	118 000	0.005	0.001		
		Maximum	129 000	0.007	0.002		
Source: [378, Industrial NGOs 2012]							

Total emissions (stack and roof) of dust and fluorides from plants using an alumina scrubber and bag filter are shown in Table 4.54. Average values shown are yearly averages. Certain roof configurations (e.g. wide open roof vents) do not allow accurate measurement of emissions to air. In these cases, environmental performance is controlled through stack emissions and ambient air quality.

Table 4.54: Total dust and fluorides emissions (stack and roof) from primary aluminium plants using an alumina scrubber and bag filter in the stack

Abatement technique	Plant	Value	Reference year (and measurement frequency)	Dust (kg/t Al)	Total fluorides (kg/t Al)
Alumina scrubber + bag filter (stack) without abatement on the roof	A	Minimum	2006–2010	0.62	0.50
		Average		0.78	0.59
		Maximum		0.87	0.68
	E	Minimum	2011	0.72	0.43
		Average		0.82	0.52
		Maximum		1.07	0.61
	F ⁽¹⁾	Minimum	2010	0.14	NR
		Average		0.39	0.31
		Maximum		0.54	0.73
	G	Minimum	2010	0.91	0.36
		Average		1.14	0.41
		Maximum		1.41	0.43
	H	Minimum	2008–2010	0.59	0.40
		Average		1.12	0.45
		Maximum		1.54	0.52
	I	Average	2010	1.16	0.74
	L	Average	2010	1.66	0.74
	FR 1	Minimum	2012 (once a month)	0.62	0.41
		Average		0.97	0.58
		Maximum		1.16	1.00
	FR 1	Minimum	2011 (once a month)	0.77	0.42
Average		0.96		0.51	
Maximum		1.13		0.55	
UK 1	Minimum	2011 (4 times a year)	0.56	0.42	
	Average		0.98	0.53	
	Maximum		1.48	0.67	
⁽¹⁾ Plant using a BSS. NB: (codification of plants does not necessarily coincide with the one previously used) NR = Not reported. Source: [378, Industrial NGOs 2012]; [390, France 2012]; [392, UK 2013].					

Total emissions (stack and roof) of dust and fluorides from plants using a wet scrubber in addition to the alumina scrubber and bag filter are shown in Table 4.55. Average values shown are yearly averages.

Table 4.55: Total dust and fluorides emissions (stack and roof) from primary aluminium plants using a wet scrubber in addition to the alumina scrubber and bag filter

Abatement technique	Plant	Value	Reference year	Dust (kg/t)	Total fluorides (kg/t)
Alumina scrubber + bag filter + wet scrubber (stack)	1	Minimum	2008–2010	0.10	0.22
		Average		0.18	0.25
		Maximum		0.48	0.35
	2	Average	2010	0.62	0.30
	3	Minimum	2009	0.12	NR
		Average		0.36	0.22
Maximum		0.70		0.44	
NB: (codification of plants does not necessarily coincide with the one previously used) NR = Not reported. Source: [378, Industrial NGOs 2012]					

Data were also provided for roof emissions from German PFPB plants (see Table 4.56).

Table 4.56: Dust and HF roof emissions from German PFPB plants using alumina scrubbers and bag filters

	Dust (mg/Nm ³)	HF (mg/Nm ³)	Monitoring frequency	Average
Roof emissions	0.1–1.5	0.1–0.6	Continuous	Daily
Source: [385, Germany 2012]				

Cross-media effects

Increase in energy use. Dry scrubbing requires a significant energy consumption of about 300–400 kWh per tonne of aluminium.

Technical considerations relevant to applicability

Dry scrubber using alumina as an adsorbent agent followed by a bag filter
Generally applicable.

Wet scrubber

The applicability of the wet scrubber may be limited in the following cases:

- very high off-gas flow rates, due to the cross-media effects (significant amounts of waste and waste water);
- in arid areas by the large volume of water necessary and the need for waste water treatment and the related cross-media effects.

Economics

The cost estimate for a possible new gas treatment centre under consideration in France in 2012 was EUR 120 million (two units costing EUR 60 million each) for a modern PFPB smelter rated at 260 000 tonnes of aluminium per year (including the ductwork mentioned in Section 4.3.3.4 above). The cost for retrofitting an existing plant would be higher.

If a BSS is included, an extra EUR 12 million would be needed to add a second network and set of valves, filters and fans in a new installation; and twice that amount or more for a retrofitting configuration.

Driving force for implementation

- Reduction of environmental impact.
- Minimisation of reagent costs.

Example plants

Plants in UK, ES, DE, NO, FR, NL, EL, IS, etc.

Reference literature

[233, COM 2008], [286, OSPAR 1998], [312, VDI 2008], [368, Haberl A. et al. 2002]

4.3.3.6 Techniques to reduce dust and fluorides from cell gases and anode production process gases

There is only one plant in Europe and two others worldwide combining pot gas and anode baking furnace gas in a common GTC. The techniques to consider are the same as in Section 4.3.3.5 (i.e. dry scrubber using alumina as an adsorbent agent, followed by a bag filter). Therefore, the environmental performance in terms of fluorides and dust is also the same. Regarding PAH, the environmental performance is the same as reported in Section 4.3.2.3 for a dry scrubber followed by a bag filter.

4.3.3.7 Techniques to prevent SO₂ emissions from cell gases

[312, VDI 2008]

Description

The technique to consider is the use of low-sulphur anodes.

Technical description

Controlling the SO₂ emissions of an aluminium smelter can be achieved by selecting raw materials with a lower sulphur content. Normally, more than 85 % of the sulphur entering a prebake smelter comes from the coke used for anode manufacturing. Controlling that inlet is the most common technique to limit any SO₂ emissions that are not trapped by the dry scrubber and the bag filter.

With regards to the process, a minimum presence of sulphur in the baked anodes is a compulsory condition to meet the density and strength requirements of the electrolytic process, and it inhibits the effect of sodium from recycled butts in the reactivity of the anode. A plant in Germany reported using anodes with an average sulphur content of 0.81 % in the first half of 2008 and 0.97 % in the second half of 2008 (i.e. a yearly average value of 0.89 %, based on 616 measurements). The same plant reported using anodes with an average sulphur content of 0.89 % in the first half of 2009 and 1.05 % in the second half of 2009 (i.e. a yearly average value of 0.97 %, based on 679 measurements). There are no technical restrictions to using cokes with a sulphur content well above 3 %.

The use of low-sulphur anodes (below 1.5 % sulphur as a yearly average) is the technique to consider for anode or anode paste manufacturing, where possible, from a production and economic point of view, and taking air quality into account. According to market conditions and availabilities, some plants will even use lower sulphur cokes than that.

Achieved environmental benefits

Reduction in total SO₂ emissions.

Cross-media effects

No information provided.

Environmental performance and operational data

Plant-specific emissions were reported both for emissions leaving the GTC (stack emissions) and for total emissions (stack emissions and roof emissions). Stack emissions are shown in Table 4.57 and Table 4.58, while total emissions are shown in Table 4.59.

According to the data reported, SO₂ stack emissions are in the range of 4.6–14.2 kg SO₂/t Al for PFPB plants (the higher end corresponding to a plant using anodes with a 1.67 % sulphur content) and 0.83–9.64 kg SO₂/t Al for Söderberg plants (the higher end corresponding to a plant using anodes with a 1.2 % sulphur content).

The SO₂ mass concentration for a mean anode sulphur content of 1.5 % ranges from 100 mg/Nm³ to 175 mg/Nm³.

Table 4.57: SO₂ stack emissions from PFPB plants using low-sulphur anodes (but not using a wet scrubber)

Abatement technique	Plant	Value	Flow (Nm ³ /h)	Flow (Nm ³ /t Al)	SO ₂ (kg/t)	S content in anodes (%)	Monitoring frequency	Average	
Low-sulphur anodes	1	Minimum	1 992 965	NR	12.41	1.40	Continuous	Monthly	
		Average	2 058 291	94 595	12.92	1.45			
		Maximum	2 114 101	NR	13.97	1.53			
	1	Minimum	2 014 707	NR	12.92	1.45	Continuous	Yearly	
		Average	2 062 179	94 595	13.10	1.48			
		Maximum	2 157 600	NR	13.30	1.50			
	2	Minimum	849 672	NR	10.93	1.08	Periodic (once a month)	Over the sampling period	
		Average	939 096	79 364	12.03	1.11			
		Maximum	1 008 000	NR	13.64	1.16			
	2	Minimum	876 335	NR	NR	11.55	1.08	Periodic (once a month)	Average of the samples obtained during one year
		Average	920 347			12.02	1.11		
		Maximum	939 096			12.47	1.16		
	3	Minimum	NR	NR	NR	NR	Periodic (approx. once a month)	Over the sampling period	
		Average			88 151	14.20			1.67
		Maximum			NR	NR			NR
	6	Minimum	NR	NR	10.27	1.40	Periodic (4 times a year)	Average of the samples obtained during one year	
		Average	3 000 000	110 000	12.33	1.60			
		Maximum	NR	NR	13.63	1.80			
	7	Minimum	828 000	NR	4.64	1.72	Periodic (once a month)	Average of the samples obtained during one year	
		Average	1 228 300	86 000	7.91	2.08			
		Maximum	1 656 000	NR	12.03	2.67			
8	Minimum	NR	NR	6.20	NR	Periodic (twice a month)	Average of the samples obtained during one year		
	Average	1 114 800	82 229	9.58					
	Maximum	1 260 000	NR	12.75					
9	Minimum	878 471	NR	10.72	NR	Continuous	Yearly		
	Average	1 413 529		11.70					
	Maximum	1 604 478		13.16					

NB: NR = Not reported.
Source: [378. Industrial NGOs 2012]

Table 4.58: SO₂ stack emissions from Søderberg plants using low-sulphur anodes (but not using a wet scrubber)

Abatement technique	Plant	Value	Flow (Nm ³ /t Al)	SO ₂ (kg/t)	S content in anodes (%)
Low-sulphur anodes	D	Minimum	20 000	0.83	NR
		Average	NR	3.30	1.20
		Maximum	30 000	7.56	NR
	E	Minimum	20 000	3.36	NR
		Average	NR	6.43	1.20
		Maximum	30 000	9.64	NR
NB: NR = not reported. Source: [378, Industrial NGOs 2012]					

Total emissions (stack and roof) of SO₂ from plants using an alumina scrubber and bag filter and low-sulphur anodes are shown in Table 4.59. Average values shown are yearly averages.

Table 4.59: SO₂ total emissions (stack and roof) from primary aluminium plants using low-sulphur anodes (but not using a wet scrubber)

Technique	Plant	Value	Reference year	SO ₂ (kg/t)	S (%)
Low-sulphur anodes	A	Minimum	2006–2010	13.15	1.45
		Average		13.35	1.48
		Maximum		13.56	1.50
	E	Minimum	2011	6.44	NR
		Average		9.93	
		Maximum		13.22	
	F ⁽¹⁾	Minimum	2010	10.27	1.40
		Average		12.33	1.60
		Maximum		13.63	1.80
	G	Minimum	2010	9.68	1.40
		Average		10.12	1.60
		Maximum		10.60	1.80
	H	Minimum	2008–2010	10.67	NR
		Average		11.78	
		Maximum		13.19	
	I	Average	2010	10.29	1.30
	L	Average	2010	8.92	1.30
	FR 1 ⁽²⁾	Minimum	2012 (mass balance)	9.25	1.02
Average		10.77		1.06	
Maximum		12.17		1.10	
FR 1 ⁽²⁾	Minimum	2011 (mass balance)	10.03	1.07	
	Average		11.70	1.09	
	Maximum		13.64	1.12	
⁽¹⁾ Plant with a BSS installed. ⁽²⁾ Sulphur content increased from a yearly average of 1 % in 2010 to an average value of 1.3 % during the first semester of 2013. NB: (codification of plants does not necessarily coincide with the one previously used) NR = Not reported. Source: [378, Industrial NGOs 2012], France 2013.					

If anodes with a yearly average sulphur content of up to 2 % were to be used, and assuming a net anode consumption of 0.43 t/t Al a yearly average of total SO₂ emissions of around 19 kg/t Al could be expected (including the contribution from the sulphur content in the alumina, calculated assuming a consumption of 1945 kg of alumina per tonne of aluminium produced, and a sulphur content in the alumina of 0.04 %).

Technical considerations relevant to applicability

Excessively low levels of sulphur in the anodes may lead to higher SO₂ emissions, as a consequence of higher anode reactivity, which would lead to higher net anode consumption.

Economics

Coke selection is a constant compromise between cost (lower sulphur content cokes are generally more expensive than high sulphur content cokes) and distance between supplier and user.

Short- to medium-term predictions forecast a rarefication of low-sulphur cokes as well.

Driving force for implementation

Reduction of environmental impact.

Example plants

Plants in UK, FR, IS, NL, ES, IT, DE, etc.

Reference literature

[296, EAA, OEA 2012]

4.3.3.8 Techniques to reduce SO₂ from cell gases from electrolysis and pot room ventilation

Description

The technique to consider is the use of a wet scrubber (see Section 2.12.5.2.2).

Technical description

Supplementary wet scrubbing (see Section 2.12.5.2.2) is mainly applied for SO₂ removal but will also reduce what is left of the fluorides after dry scrubbing, and, to a lesser extent, dust. Wet scrubbing can be applied to electrolytic cell gases after they have been treated by dry scrubbing and just before their release from the stack. Only one plant currently applies wet scrubbers, in this case for the pot room ventilation air. The high hooding efficiency values of point feeding system make pot room ventilation air treatment unnecessary, unless specific local conditions require it.

Achieved environmental benefits

Reduction of SO₂ and, to a lesser extent, dust and fluorides emissions.

Environmental performance and operational data

Removal efficiencies for SO₂ of 80–90 % have been identified for wet scrubbers. At the stacks after treatment of pot process gas, SO₂ emissions can be reduced to concentrations of 5–40 mg/Nm³ and loads of 0.5–2.5 kg SO₂/t Al. In addition, the supplementary wet scrubbing results in a reduced emission of fluorides and dust. Emission levels at the stack for total fluorides (gaseous and particulate) of 0.02–0.2 kg/t Al have been identified when wet scrubbing is applied for supplementary abatement. In these situations, stack dust emissions are reduced to 0.1–0.3 kg/t Al.

SO₂ emissions from PFPB plants and from a Söderberg plant, all using wet scrubbers in addition to alumina scrubbers and bag filters, are shown respectively in Table 4.60 and in Table 4.61.

Table 4.60: SO₂ emissions from PFPB plants using a wet scrubber in addition to an alumina scrubber and a bag filter

Abatement technique	Plant	Value	Flow (Nm ³ /h)	SO ₂ (kg/t)	S content in anodes (%)	Monitoring frequency	Average
Alumina scrubber + bag filter + wet scrubber	A	Minimum	260 362	0.02	1.4	NR	NR
		Average	272 228	0.10	1.4		
		Maximum	278 931	0.24	1.4		
	B	Minimum	123 287	NR	NR	Periodic (twice a month)	Over the sampling period
		Average	158 473	2.07			
		Maximum	202 761	NR			
	C	Minimum	241 963	1.12	NR	Periodic (twice a month)	Over the sampling period
		Average	284 575	1.36			
		Maximum	326 893	1.87			
NB: Codification of plants does not necessarily coincide with the one previously used. NR = Not reported. Source: [378, Industrial NGOs 2012]							

Table 4.61: SO₂ emissions (stack and roof) from a Søderberg plant using a wet scrubber in addition to an alumina scrubber and a bag filter

Abatement technique	Plant	Value	Flow (Nm ³ /h)	SO ₂ (kg/t)	S content in anodes (%)	Monitoring frequency	Average
Alumina scrubber + bag filter + wet scrubber	F	Minimum	260 362	0.09	NR	NR	NR
		Average	272 228	0.12	1.4		
		Maximum	278 931	0.14	NR		
NB: Codification of plants does not necessarily coincide with the one previously used. NR = Not reported. Source: [378, Industrial NGOs 2012]							

Total emissions (stack and roof) of SO₂ from plants using a wet scrubber in addition to the alumina scrubber and bag filter are shown in Table 4.62. Average values shown are yearly averages.

Table 4.62: SO₂ total emissions (stack and roof) from primary aluminium plants using a wet scrubber in addition to alumina scrubbers and bag filters

Abatement technique	Plant	Value	Reference year	SO ₂ (kg/t)
Alumina scrubber + bag filter + wet scrubber (stack)	G	Minimum	2008–2010	0.28
		Average		0.38
		Maximum		0.54
	H	Average	2010	2.23
		I	Minimum	2009
	Average		1.44	
	Maximum		2.01	

NB: Codification of plants does not necessarily coincide with the one previously used.
Source: [378, Industrial NGOs 2012]

Cross-media effects

Increase in energy consumption

Seawater scrubbing requires an additional energy consumption of about 100–150 kWh/t Al, depending on the scrubbing technology and the local conditions. For example, for seawater scrubbing, the distance from the sea and the altitude of the plant are significant drivers for energy consumption.

Discharge of the absorbed and converted pollutants

Discharges can occur as large amounts of waste water, fluid alkaline waste, or as gypsum fine particle slurry. The results of environmental monitoring in the sea and in air should be taken into account to determine the overall reduction in emissions and the applicability of the process, which transfers pollutants from the air to the water and/or to the soil [355, NERC 2010]

The effluent from wet scrubbers using seawater (approximately 80–200 m³/t Al) is slightly acidic and contains sulphite/sulphate, some fluorides, and suspended matter, and is deficient in oxygen. Plants using seawater may therefore have installations for the oxidation of sulphites to sulphates, and for the removal of suspended solids to comply with national legislation for the discharge of this waste water to the sea. Waste water treatment may include flocculation and sedimentation. The waste water treatment results in a sludge that requires disposal. The seawater used in the wet scrubbers may also need to be treated with biocides, which will subsequently be discharged into the sea too.

The scrubbers operated with NaOH require the discharge of a concentrated effluent (about 1 m³/t Al). The pollutants in this effluent can be compared to the pollutants in the discharged seawater, but they occur in higher concentrations. Nevertheless, the effect on the aquatic environment will remain.

Technical considerations relevant to applicability

The applicability of the wet scrubber may be limited in the following cases:

- very high off-gas flow rates, due to the cross-media effects (significant amounts of waste and waste water);
- in arid areas by the large volume of water necessary and the need for waste water treatment and the related cross-media effects.

Economics

Cost estimates have been identified for supplementary wet scrubbing of the pot process gas. The cost estimates are presented for scrubbing systems operated with seawater, as well as NaOH.

- Seawater: the cost was estimated for the possible installation of the technique in a 260 000 t Al/yr French smelter. In this case, two seawater scrubbing units would be

needed, generating an extra cost of EUR 35 million each, i.e. EUR 125–130/t Al, water pumped for 3 km, no oxidation pool.

- NaOH: investment, depending on the plant size, of EUR 12–40 million, i.e. EUR 100–250 per tonne of capacity. Total annual costs: EUR 4–7 million, i.e. EUR 100–200/t Al.
- Double alkali, with land disposal of contaminated slurries: for one plant in France with no access to seawater, a preliminary cost estimate indicated much higher figures: EUR 69–92 million, i.e. EUR 650–850/t Al. Total annual costs: EUR 6.5–9.5 million, i.e. EUR 60–90/t Al.

The Netherlands have made a comparison between the cost-effectiveness of the SO_x abatement techniques of two smelters [241, Infomil 2008] that confirms the orders of magnitudes presented for seawater and NaOH above. Altogether, cost data have been compiled for a variety of processes and abatement systems. The cost data are very site-specific and depend on a number of factors but the ranges given may enable some comparisons to be made.

Driving force for implementation

Reduction of SO₂ emissions to air in locations where controlling the sulphur content in coke is not sufficient to meet air quality standards.

Example plants

Plants in Norway (six wet scrubbers with seawater at coastal sites and one NaOH scrubber at an inland site) and Sweden, and some preliminary cost estimates for two French plants (though no real plant has installed these units yet).

Reference literature

[97, Lijftogt, J.A. et al 1998], [303, ENVIRONNEMENT CANADA 2008], [316, Wedde et al. 2004], [347, Alcoa 2010], [348, Solios 2010], [368, Haberl A. et al. 2002]

4.3.3.9 Techniques to reduce emissions from melting and molten metal treatment and casting in primary aluminium smelters

Description

The techniques to consider are:

- the use of liquid metal from electrolysis and uncontaminated material (i.e. material free of paint, plastic, oil, etc.);
- bag filter.

Technical description

Casthouses integrated with the primary aluminium smelter are only allowed to melt commercial metal and scrap. The scrap melted in these sites includes internal company scrap from extrusion and rolling without substances such as paint, plastic or oil (including customer returns without paint or plastic, and scrap from sites belonging to the same company), and scrap bought on the market that does not contain substances such as paint, plastic or oil.

In an integrated smelter, dust emissions from the casthouse represent around 5 % of total dust emissions. In order to reduce these emissions, some plants are using bag filters.

Achieved environmental benefits

Reduction of dust emissions.

Environmental performance and operational data

Reported emissions of dust from casthouses integrated into primary smelters and using bag filters show yearly average values below 2.5 mg/Nm³, and maximum averages over the sampling period of 7.9 mg/Nm³.

In cases of this type of casthouse not applying bag filters, reported yearly averages of dust range between 7.38 mg/Nm³ and 40 mg/Nm³, with at least three plants reporting yearly averages around 20 mg/Nm³ or below.

Information provided shows that, even if no abatement technique is applied, monitoring of dust is carried out at this stage of the process.

Cross-media effects

Increase in energy use.

Technical considerations relevant to applicability

Generally applicable.

Economics

Since casthouses in integrated primary smelters represent a minor source of the total dust emissions from the smelter, it should be assessed, on a case-by-case basis, whether resources allocated to reduce dust emissions would be more efficiently allocated at this stage of the process or at others.

Driving force for implementation

Reduction of dust emissions.

Example plants

Three primary smelters reported using bag filters in the casthouse.

Reference literature

[296, EAA, OEA 2012], [378, Industrial NGOs 2012]

4.3.3.10 Techniques to reuse the spent pot lining (SPL)**Description**

The technique to consider is the use of the carbon content as a raw material for other applications.

Technical description

Several successful applications use the SPL carbon content in thermal processes such as:

- cement firing;
- steel and ferro-alloy production, as a carburant;
- rock wool production, as a coke substitute.

Achieved environmental benefits

- Reduction of fossil fuel consumption.
- Reduction of raw material when the SPL is used for the AlF₃ content.
- Destruction of the CN content.
- Reduction of waste deposit on land.

Environmental performance and operational data

No information provided.

Cross-media effect

No information provided.

Technical considerations relevant to applicability

Generally applicable.

Economics

No net income, but avoidance of treatment or disposal charges.

Driving force for implementation

Reduction of waste sent for disposal and recovery of carbon content.

Example plants

Plants in FR, NO and ES.

Reference literature

[103, COM 1998], [233, COM 2008], [376, Regain 2011].

4.3.4 Secondary aluminium

4.3.4.1 Techniques to reduce emissions from the storage, handling and transport of the raw materials used for secondary aluminium production

General techniques applied to reduce diffuse emissions from the storage, handling and transport of raw materials for secondary aluminium production are considered in Chapter 2 (see Section 2.12.4.1) and in the Emissions from Storage BREF [290, COM 2006].

Description

The technique to consider for the abatement of dust-channelled emissions is a bag filter (see Section 2.12.5.1.4).

Technical description

There are varieties of secondary raw materials and they range from fine dusts (fluxes, salt, skimmings or dross) to large single items. Due to the potentially dusty nature of fluxes, salt and skimmings/dross, dust may be collected and abated at specific conveyor transfer points and at grinding and separation operations using a bag filter.

Achieved environmental benefits

- Reduction of emissions to air.
- Recovery of raw materials.

Environmental performance and operational data

Table 4.63 shows the data provided for emissions from the transport and loading of materials for secondary aluminium production.

Table 4.63: Dust emissions from the transport and loading of materials for secondary aluminium production

Plant	Technique	Pollutant	Values (mg/Nm ³)			Periodic measurement
			Min.	Avg.	Max.	
65	Bag filter	Dust	0.5	0.75	1	Twice a year
67	Bag filter	Dust	2.3	3.25	4.2	

Source: [378, Industrial NGOs 2012]

Cross-media effects

Increase in energy use.

Technical considerations relevant to applicability

Generally applicable.

Economics

No information provided.

Driving force for implementation

- Recovery of material for reuse.
- Environmental regulation requirements.

Example plants

Plant 65 and Plant 67.

Reference literature

[296, EAA, OEA 2012],

4.3.4.2 Techniques to separate non-metallic components and metals other than aluminium and to reduce their size before the melting stage

Description

The techniques to consider are a combination of the following:

- magnetic separation (ferrous metal components);
- eddy current separation;
- relative density separation (e.g. sink floatation).

Technical description

These techniques are used in order to increase the variety of scraps that can be used and to increase the quality of raw material. After treatment, the scraps may be used in rotary or stationary furnaces.

These techniques are used on scraps that have generally been crushed previously.

Magnetic separation

After crushing, generally in a hammer mill, the scraps are moved by belt conveyors and iron is removed by magnetic devices.

Eddy current separation

After the magnetic separation to remove non-metallic constituents from crushed scraps, eddy current separation is applied. An electromagnetic field separates aluminium and other non-ferrous metals (copper, zinc, magnesium, etc.) from non-metallic constituents like rubber, plastic and wood based on the different magnetic properties of the constituents.

Relative density separation

This technique also achieves separation of aluminium from other non-ferrous metals, and so it is possible to obtain high-grade quality scraps. The crushed scraps go through vessels containing different density fluids (normally from 1–3 kg/l). Material, after density separation, is drained and dries during storage, before going to the furnace; otherwise a drying stage is needed.

Achieved environmental benefits

- Recovery of other metals (iron, copper, lead).
- Better selection of feed raw materials for the melting process.
- Reduction of pollutants emitted, salt fluxes used and dross produced.

Environmental performance and operational data

The main environmental effect of these techniques is the reduction of impurities (especially non-metallic constituents) from feed scraps.

Table 4.64 shows the dust emissions from the milling stage.

Table 4.64: Dust emissions from the milling stage in secondary aluminium production

Plant	Technique	Pollutant	Values (mg/Nm ³)			Periodic measurement
			Min.	Avg.	Max.	
66	Bag filter	Dust	0.6	0.95	1.3	Twice a year
75	Bag filter	Dust	NR	3.8	NR	Once a year

NR = Not reported.
Source: [378, Industrial NGOs 2012]

Cross-media effects

- Increase in energy use.
- Generation of waste (non-metallic constituents).

Technical considerations relevant to applicability

These techniques are generally applicable when it is necessary to increase the quality of scraps and to prepare feed that fits the furnace and its off-gas treatment plant features.

Economics

No information provided.

Driving force for implementation

- Improvement in the quality of aluminium scraps.
- Environmental legislation requirements.

Example plants

Four Italian plants.

Reference literature

[296, EAA, OEA 2012]

4.3.4.3 Techniques to remove oil and organic compounds from swarf before the melting stage

Description

The techniques to consider are:

- centrifugation;
- drying using a rotary dryer.

Technical descriptions

Machined swarf is mostly contaminated with cutting oil or other chemicals used during the machining of the metal.

Centrifugation

Highly contaminated swarf can be centrifuged to remove most of the oil.

Drying using a rotary drum dryer

Drying using a rotary dryer can completely remove oil and other organic chemicals. The swarf drying process using a rotary drum dryer is based on indirect or direct heating technology. The dryer is heated indirectly to avoid local superheating which would result in an increased oxidation of the swarf. Swarf is charged via conveyor belt and bucket elevator into the drum.

The temperature for the swarf dryer is often controlled at 300–400 °C in order for pyrolysis to take place while minimising metal oxidation. The pyrolysis gases from the dryer are combusted in an afterburner to achieve complete combustion. New dryers are designed with an afterburning system with new technologies that enable the energy generated from the pyrolysis gas to be

returned to the dryer (closed loop). Given the high organic content of the pyrolysis gases, an afterburner or afterburning system can effectively convert the organic compounds to CO₂ in most cases without any additional energy input.

At the other end of the dryer, the material is cooled with fresh air, and any iron is separated via magnetic separation before storage.

Achieved environmental benefits

- Removal of oil and organic compounds from swarf before the melting stage.
- Reduction of emissions from smelting (especially organic compounds).
- Reduction of salt fluxes used and dross produced.

Environmental performance and operational data

Dust in waste gas is removed by a bag filter and emissions from 1 mg/Nm³ to 10 mg/Nm³ are reported, based on periodic measurements.

Organic compounds, such as TVOC, are reduced by an afterburner and emissions from 1 mg/Nm³ to 6 mg/Nm³ are reported, based on periodic measurements. Continuous measurement shows the highest emission value up to 18 mg/Nm³.

PCDD/F emissions from 0.002 ng/Nm³ to 0.15 ng/Nm³ are reported.

Table 4.65 gives more data about the emissions from the swarf dryer.

Table 4.65: Emissions from swarf dryers

Plant	Technique	Pollutant (Unit)	Values			Monitoring frequency
			Min.	Avg.	Max.	
20	Swarf dryer - afterburner - lime injection - bag filter	Dust (mg/Nm ³)	0.1	0.2	0.2	Periodic
		PCDD/F (ng I-TEQ/Nm ³)	NA	0.043	NA	Periodic
		NO ₂ (mg/Nm ³)	10	20	22	Periodic
		TVOC (mg/Nm ³)	0.7	0.9	1.1	Periodic
		CO (mg/Nm ³)	3	3	4	Periodic
		HCl (mg/Nm ³)	0.7	1.3	2.7	Periodic
22	Swarf dryer - afterburner - lime injection - bag filter	Dust (mg/Nm ³)	0.3	0.5	0.6	Periodic
		NO ₂ (mg/Nm ³)	43	44	45	Periodic
		TVOC (mg/Nm ³)	< 1	< 1	< 1	Periodic
24	Swarf dryer - afterburner - water quenching - lime injection - bag filter	Dust (mg/Nm ³)	1.1	1.4	2	NR
		PCDD/F (ng I-TEQ/Nm ³)	NA	0.009	NA	Periodic
		NO ₂ (mg/Nm ³)	28	30	31	NR

		TVOC (mg/Nm ³)	< 1	1	1	Continuous
		CO (mg/Nm ³)	24	26	30	Periodic
25	Swarf dryer - afterburner - water quenching - lime injection - bag filter	Dust (mg/Nm ³)	< 0.3	0.3	0.4	NR
		PCDD/F (ng I-TEQ/Nm ³)	NA	0.006	NA	Periodic
		NO ₂ (mg/Nm ³)	30	31	31	NR
		TVOC (mg/Nm ³)	< 1	< 1	< 1	Continuous
		CO (mg/Nm ³)	13	14	20	Periodic
26	Swarf dryer - afterburner - water quench - lime injection - bag filter	Dust (mg/Nm ³)	< 0.5	0.6	0.8	NR
		PCDD/F (ng I-TEQ/Nm ³)	NA	0.021	NA	Periodic
		NO ₂ (mg/Nm ³)	31	33	40	NR
		TVOC (mg/Nm ³)	< 1	< 1	< 1	Continuous
		CO (mg/Nm ³)	7	7	10	Periodic
29	Swarf dryer - afterburner - lime injection - bag filter	Dust (mg/Nm ³)	NR	< 0.3	NR	NR
		PCDD/F (ng I-TEQ/Nm ³)	NA	0.002	NA	Periodic
		NO ₂ (mg/Nm ³)	NR	0.01	NR	NR
		TVOC (mg/Nm ³)	< 1	4	18.3	Continuous
		CO (mg/Nm ³)	NR	106	NR	Periodic
		HCl (mg/Nm ³)	< 0.03	< 0.26	0.5	Periodic
39	Swarf dryer - afterburner	NO ₂ (mg/Nm ³)	51	80	101	Periodic
		TVOC (mg/Nm ³)	0.3	8	32	Continuous
		CO (mg/Nm ³)	3	46	96	Periodic
68	Swarf dryer - bag filter - NaHCO ₃ and activated carbon injection	Dust (mg/Nm ³)	1.2	2.2	3.2	Periodic
		PCDD/F (ng I-TEQ/Nm ³)	0.25	NR	0.44	Periodic
		NO ₂ (mg/Nm ³)	80	100	120	Periodic
		VOCs (mg/Nm ³)	NR	3.5	NR	Periodic

		HCl (mg/Nm ³)	3.2	5	6.8	Periodic
		HF (mg/Nm ³)	NR	1.5	NR	Periodic
70	Swarf dryer - bag filter - NaHCO ₃ injection	Dust (mg/Nm ³)	0.2	2.0	3.9	Periodic
		PCDD/F (ng I-TEQ/Nm ³)	0.03	0.06	0.09	Periodic
		NO ₂ (mg/Nm ³)	62	74	87	Periodic
		VOCs (mg/Nm ³)	2	4	6	Periodic
		CO (mg/Nm ³)	27	61	96	Periodic
		HCl (mg/Nm ³)	0.8	1.5	2.3	Periodic
		HF (mg/Nm ³)	0.1	0.25	0.4	Periodic
74	Swarf dryer - afterburner - bag filter	Dust (mg/Nm ³)	0.9	5.1	9.3	Periodic
		PCDD/F (ng I-TEQ/Nm ³)	0.05	0.15	0.25	Periodic
		NO ₂ (mg/Nm ³)	60	105	150	Periodic
		SO ₂ (mg/Nm ³)	NR	15	NR	Periodic
		VOCs (mg/Nm ³)	16	28	40	Periodic
		CO (mg/Nm ³)	70	82	95	Periodic
		HCl (mg/Nm ³)	7	8	9	Periodic
		HF (mg/Nm ³)	1	1.4	1.8	Periodic
AT	Swarf dryer - afterburner - bag filter	Dust (mg/Nm ³)	1.3	NR	2.8	Periodic
		NO _x (mg/Nm ³)	69	NR	101	Periodic
		VOCs (mg/Nm ³)	0.3	NR	29	Periodic
		CO (mg/Nm ³)	3	NR	97	Periodic
NB: NA = Not available; NR = Not reported. Source: [378, Industrial NGOs 2012], [393, Austria 2012]						

Cross-media effects

- Increase in energy use.
- Emission of CO₂ and NO_x.

Technical considerations relevant to applicability

Generally applicable, unless the furnace and abatement system are specifically designed to accommodate the organic content.

Economics

No information provided.

Driving force for implementation

- Improvements in the quality and metal yield of aluminium scraps.
- Reduction of salt fluxes.
- Reduction of the VOCs emitted from the smelter.

Example plants

Plants in AT, DE and IT.

Reference literature

[296, EAA, OEA 2012]

4.3.4.4 Selection of the appropriate secondary melting furnaces

Description

The techniques to consider are:

- reverberatory furnaces (hearth or closed well);
- rotary drum furnaces;
- induction furnaces;
- shaft furnaces.

Technical description

Different types of scrap present particular challenges to the melting process. When block material is melted, compared to pieces with higher specific areas, it requires less protection against oxidation. Thus, the development and the selection of melting furnaces depend to a large extent on the type of the input scrap material used, and its size, oxide content and degree of contamination.

Furnaces can be separated into two groups, i.e. fuel-heated and electrically heated. Fuel-heated furnaces are more widely applied in the secondary aluminium production process.

Table 4.66 gives an overview of the advantages and disadvantages of secondary smelting and melting furnaces and the raw materials that can be recovered in them.

Reverberatory furnaces (hearth or closed well)

The reverberatory furnace is the 'classic' furnace and several variations have been developed for individual applications. The principle design of this type of furnace comprises a closed refractory-lined rectangular box. One or more burners provide the energy while the flue-gases escape through an opening in the roof or in the furnace wall. The furnace can be stationary or tiltable. The standard reverberatory furnace is highly suitable for melting large pieces of metal such as sows, ingots, compacted bales, etc. and when no salt is required.

When the furnace is equipped with an exterior side well, scraps can be charged directly into liquid metal thus limiting the contact of scrap with flue-gas and ambient air. In this case, smaller scraps can also be processed. However, the heat loss through the side well is considerable and the melting rate is low.

Scraps that are highly contaminated with organic material but less contaminated with other metals may be best melted in a reverberatory furnace. No salt is needed, as the organic contents are afterburnt in the furnace.

Rotary drum furnaces

The design principle of these furnaces (which can be fixed axis or tilting furnaces) comprises a refractory-lined steel vessel that rotates around the central axis. Scrap is charged through the front opening. The burner can be arranged at the front side or at the rear side. Traditionally the rotary drum has a fixed axis, which means that the centre line of the rotation remains in the horizontal position. A large variety and size of scraps can be processed in rotary furnaces. Although the small scraps have a large specific surface, the surface exposed to the furnace atmosphere is quite small. A salt flux is added to protect the material from oxidation. The tilting rotary furnace requires less salt than the fixed axis furnace. Depending on the quality of the scraps, and using a tilting rotary furnace, the salt factor (kg of salt per kg of non-metallic product) could be reduced to less than 0.5.

For slag discharge in the fixed axis furnace, a large taphole is located at the circumference of the drum. The slag is collected in slag bins underneath the furnace. The tapping of liquid metal and slag discharge can be time-consuming.

For tilting furnaces, a very large charging opening is achieved by tilting the furnace back. For melting, the furnace rotates in the back-tilted position. To discharge metal, the furnace is positioned horizontally, or slightly forward-tilted, so that liquid metal can flow out into a launder system. After the metal is tapped, slag is removed by tilting the furnace further and, with the drum slowly rotating, discharged into containers below the furnace's opening. In this way, the difficulties of fixed axis furnaces in tapping and discharging can be overcome.

Induction furnaces

Induction furnaces use electricity to melt the scrap. Induction heating uses the contactless power transmission between a coil and electrically conductive charge, i.e. aluminium scrap. Because there are no flue-gases, the oxidation loss is low and there is no contamination by the flue-gas. However, induction furnaces process turnings or clean scrap and often the capacity is fairly small for a modern secondary aluminium plant.

Shaft furnace

The design of this furnace applied to the aluminium sector is similar to that reported in Annex 13.1. In the aluminium sector, this furnace is used to melt ingots and foundry returns.

Table 4.66: Advantages and disadvantages of secondary melting furnaces

Furnace type	Variations	Principal application	Advantages	Disadvantages	Gas collection	Comments
Reverberatory or closed well	Standard	Melting larger volumes of clean scraps and feedstock contaminated with organic materials	<ul style="list-style-type: none"> • Large metal capacity (100 t) • Few restrictions on feedstock sizes • No salt use 	<ul style="list-style-type: none"> • Lower thermal efficiency • Restricted feedstock types 	Semi-sealed	<ul style="list-style-type: none"> • High yields due to quality of feedstock • Molten metal pumps possibly used
	Side well	As above, but enables efficient recovery of some finer feedstocks	<ul style="list-style-type: none"> • Large metal capacity • Wider range of feedstock possible • Normally no salt use 	Lower thermal efficiency	Semi-sealed	<ul style="list-style-type: none"> • High yields possible depending on quality of feedstock • Molten metal pumps possibly used
	Sloping hearth	Separation of aluminium from higher melting point metal contamination (i.e. iron/steel)	<ul style="list-style-type: none"> • Very efficient at removing high melting point contaminants 	Lower thermal efficiency	Semi-sealed	<ul style="list-style-type: none"> • Sometimes incorporated into other furnace types • Yield dependent on level of contamination
Rotary	Fixed axis	Recycling a wide range of feedstocks	<ul style="list-style-type: none"> • No feedstock restrictions • Good thermal efficiency • Efficient demagging • No skimmings/dross produced • Large charge volumes possible (> 65 t) 	<ul style="list-style-type: none"> • Relatively high usage of salt cover • Feedstock size may be restricted 	Semi-sealed	<ul style="list-style-type: none"> • Resultant salt slags must be reprocessed
	Tilting	Same as fixed axis	<ul style="list-style-type: none"> • Same as fixed axis, but lower usage of salt cover and lower capacity 	Feedstock size may be restricted	Semi-sealed	<ul style="list-style-type: none"> • Resultant salt slags must be reprocessed • Tends to be used for lower scrap grades and dross

Induction	Coreless	Melting of cleaner scraps or primary feedstock	<ul style="list-style-type: none"> • High yields obtained • No combustion gases • No salt cover required • Flexible usage (batch and continuous processing possible) 	<ul style="list-style-type: none"> • Relatively small load (< 10 t) • Restricted feedstock type • Feedstock size may be restricted 	Open, hooded	
	Channel	Same as coreless	<ul style="list-style-type: none"> • High yields obtained • No combustion gases • No salt cover required 	Same as coreless, but suitable for larger capacity (~ 20–25 t)	Semi-sealed	
Shaft		Melting clean ingots and process scraps in foundries	<ul style="list-style-type: none"> • Better thermal efficiency 	<ul style="list-style-type: none"> • Restricted feedstock types • Feedstock size may be restricted 	Semi-sealed	Used in Meltower process

Environmental performance and operational data

The reuse of filter dust from secondary aluminium production is demonstrated in Spain, Austria and Italy. In this case, dust and fume from a rotary furnace are treated with sodium bicarbonate and activated carbon as the scrubbing medium to remove chlorides produced by the salt cover, and sodium chloride is formed. The dust is then collected in a fabric filter and can be included with the salt charged to the furnace.

Input material, i.e. scrap, often contains a certain amount of organic contaminants, which are the source of organic carbon emissions (expressed as total volatile organic carbon, TVOC). Depending on the furnace design, additional air or oxygen can be injected into the melting furnace in order to reduce TVOC (Germany).

Metal pumps or electromagnetic stirring should be used to increase efficiency, as well as applying sealed charging systems and targeted fume collection to prevent dust emissions and to preheat the charge, depending on the furnace type. It is necessary to select the feed material to suit the furnace type and abatement systems used, and to transfer unsuitable raw materials to other operators using equipment designed for this purpose. (See Table 4.28).

Cross-media effects

See the disadvantages column in the table above.

Technical considerations relevant to applicability

These techniques are applicable to all secondary aluminium plants depending on the type of raw material used.

Economics

No information provided.

Driving force for implementation

- Increase in energy efficiency.
- Increase in recovery yield.
- Environmental regulation requirements.

Example plants

Plants in DE, BE, UK, AT, ES and IT.

Reference literature

[256, Winter 2007], [272, Al input 2008], [269, Broom 2005], [312, VDI 2008], [394, Schmitz 2006]

4.3.4.5 Techniques to reduce diffuse emissions to air from melting furnaces in secondary aluminium production

Description

The techniques to consider are:

- hood and sealed furnace door;
- sealed charging carriage;
- targeted fume collection.

Technical description

Furnace operations, especially charging and discharging, can result in the leaking of gases into the ambient air. Such gases are dusty and often also contain partially combusted organic contaminants from the input scrap and possibly incomplete combustion elements from the fuel. For input material with substantial organic contaminants, e.g. coating, oil and paint, the furnace is provided with excess air or oxygen to burn off the pyrolysed organic compounds. This both utilises the organic contaminants for heat generation and at the same time reduces the amount of organic carbon emissions in the flue-gas. If needed, an afterburner could be used to fully convert the organic carbon into CO₂.

Hood and sealed furnace door

A furnace door is designed to cope with the heat inside and the cool ambient air outside. It must be easy to operate and properly sealed to maintain the positive pressure inside the furnace. The hood is designed to prevent any leakage of fumes into the environment when the furnace door is open (for example during the charging) and to collect diffuse emissions.

Reverberatory furnace: One of the modern designs of the furnace door comprises a sturdy frame made of individual sections of heat-resistant castings. The frame is embedded in the refractory material to a high degree so that the area for heat transfer is very small. The door frame also carries the sealing system. For sealing, a heat-resistant asbestos-free mineral wool rope is used. The rope holders are made of individual sections and allow adjustment of the sealing as necessary. For closing, hydraulic cylinders press the entire door against the door frame ensuring a tight sealing.

Some furnaces are designed to generate the sealing force by moving the door roller along a guide profile. For proper application of this sealing force, the guide profiles are designed as swivel arms, which allow the complete door structure to be moved away from the door frame for lifting, thus clearing the sealing rope completely or allowing the powerful pressing of it against the door frame.

In the case of a reverberatory furnace, the best position for the flue-gas discharge is above the furnace door, where the exhaust hood or flue duct should be placed. The preheating ramp is located here. As the flue-gas passes this area, a good heat transfer is assured. The flue duct may also be located elsewhere and still enable a good heat distribution in the furnace. This is because the high-velocity burners create substantial turbulence in the furnace, with a resultant heat transfer irrespective of the main flow direction.

Fixed axis rotary furnace: Apart from the furnace door and taphole, the entire fixed axis furnace is closed and insulated to prevent energy loss and to prevent diffuse emissions. Therefore, the

furnace door design is one of the most important features. The door is designed to be sealed and easy to operate. To collect diffuse emissions, an exhaust hood is placed on the top end of the furnace door.

In the case of a conventional stationary rotary furnace, the charging door may be completely housed inside a steel chamber. However, such a set-up is more difficult to operate and requires a substantial amount of air in order to be efficient, which in turn requires a large filtering installation.

One design in the case of rotary furnaces is that the door covers the lower half of the drum opening and is sealed against the drum by a dynamic system with an airlock. The air is provided through the swivel arm of the door. The exhaust hood is fitted in the upper half of the furnace opening. It is sealed against the rotating drum using the same system as for the door. With proper sizing of the hood, any flue-gases escaping from the drum when the door is opened are taken up efficiently into the waste gas system.

Alternatively, a fume collection enclosure is used to cover both the charging and tapping zones of a rotary furnace to allow the use of a single extraction point, see Figure 4.12.

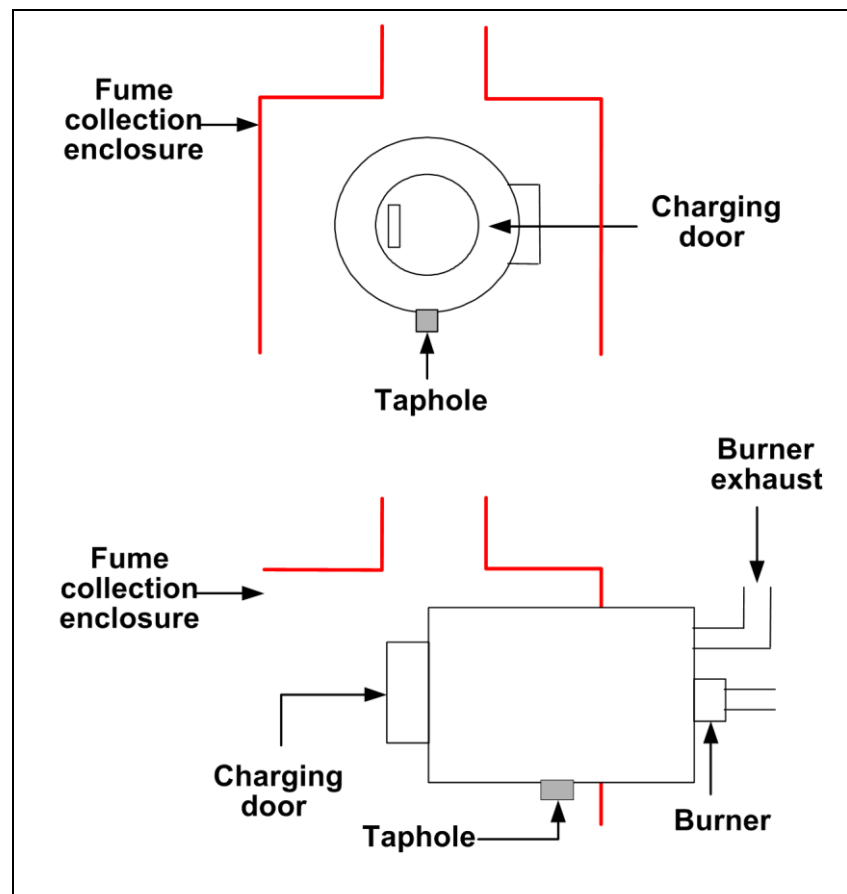

Figure 4.12: An illustration of an integral fume collection system

Sealed charging carriage

A charging car or skip is used to transfer scrap into a furnace. The system is sized so that the skip seals against the open furnace door during the discharge of scrap and so maintains furnace sealing during this period. The system can also incorporate a chamber to allow preheating of scrap before charging.

Targeted fume collection

A fume collection system can be designed so that the collection fan can be directed to sources of fumes that change over the charging, melting and tapping cycles. The targeting of fume collection can be achieved by using automatically controlled dampers that are linked to the furnace controls, e.g. door opening, burner state or furnace inclination. Damper operations can therefore be initiated by charging, melting and tapping operations and the fume collection effort can be targeted accordingly. The burner rate is also automatically controlled during charging to ensure the minimum gas flow when the door is open.

Achieved environmental benefits

Hood and sealed furnace door

- Prevention of diffuse emissions.
- Reduction of energy consumption.

Sealed charging carriage

- Prevention of diffuse emissions during the charging of scrap.

Targeted fume collection

- Prevention of diffuse emissions.
- Reduction of energy consumption.

Cross-media effects

No information provided.

Environmental performance and operational data

No information provided.

Technical considerations relevant to applicability

Generally applicable. The sealed charging carriage can only be applied to non-rotating furnaces.

Economics

No information provided.

Driving force for implementation

- Reduction of diffuse emissions.
- Recovery of energy.

Example plants

Plants in BE, AT, ES, DE and IT.

Reference literature

[118, Laheye, R. et al. 1998], [231, COM 2007], [296, EAA, OEA 2012], [394, Schmitz 2006]

4.3.4.6 Technique to reduce dust emissions to air from the melting process

Description

The technique to consider is the use of a bag filter.

Technical description

Most secondary aluminium plants use a bag filter to reduce the dust and metals emission. In the bag filter, the off-gas is passed through a tightly woven or felted fabric, causing dust to be collected on the fabric bag by sieving or other mechanisms. The dust cake that forms on the bag can significantly increase the collection efficiency, and, when an absorbent agent is used to

abate other pollutants (e.g. acid), this reaction also takes place on the surface of the bags (see Section 2.12.5.1.4).

Achieved environmental benefits

Reduction of dust and metals emissions.

Environmental performance and operational data

Figure 4.13 below shows the maximum, average and minimum dust emissions according to the data provided [378, Industrial NGOs 2012].

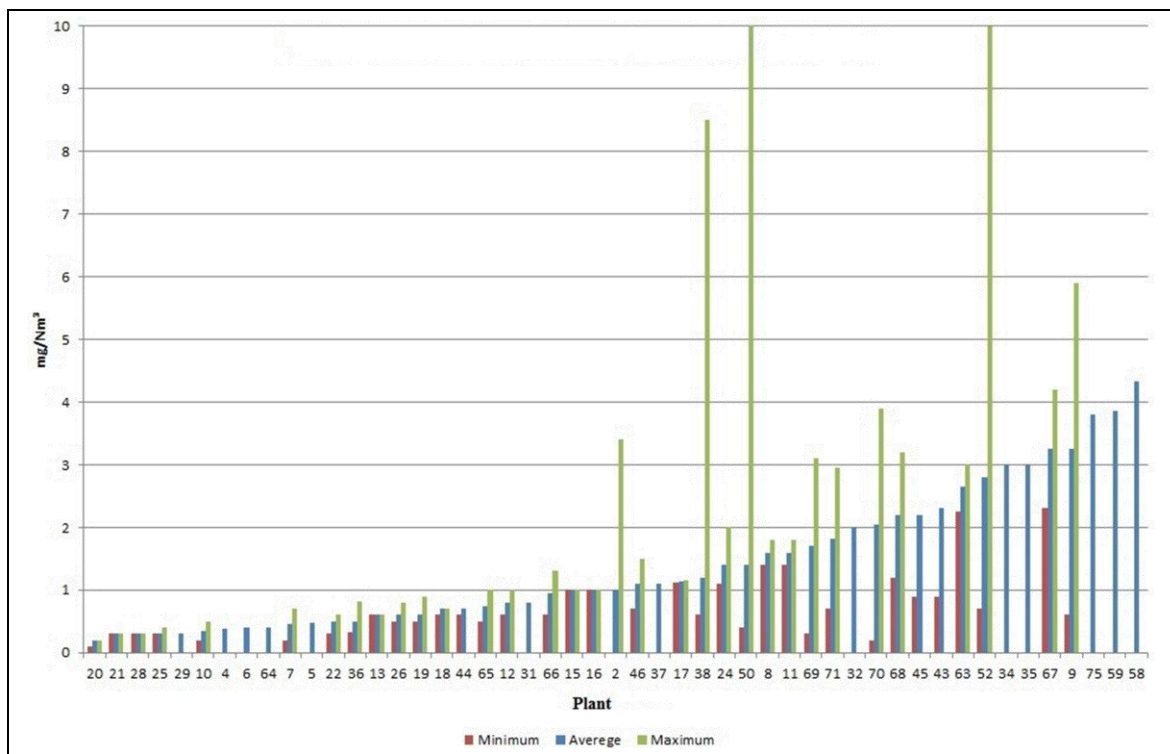

Figure 4.13: Dust emissions from the melting process in secondary aluminium production plants

Of the plants, 55 % reported continuously monitoring dust emissions. The percentage of dust emissions measured continuously increases to 65 % if only the plants in the range between 2 g/h and 100 g/h of dust emitted as a yearly average or the average of the measurements taken in a year are considered.

Table 4.67: Emissions from the melting process of an Austrian plant

Technique	Pollutant	Unit	Values			Monitoring frequency
			Max.	Avg.	Min.	
Rotary drum furnace - bag filter	Dust	mg/Nm ³	1.6	NR	1.4	Periodic
	NO ₂	mg/Nm ³	157	NR	10	Periodic
	PCDD/F	ng/Nm ³	NR	< 0.1	NR	Periodic
	HCl	mg/Nm ³	24.6	NR	3.5	Periodic
	HF	mg/Nm ³	4.7	NR	0.2	Periodic
	Hg	mg/Nm ³	0.002	NR	0.001	Periodic
	Pb, Zn, Cr, Cu, Mn, V, Sn	mg/Nm ³	0.047	NR	0.045	Periodic
Tilting rotary furnace - afterburner - lime injection - bag filter	Dust	mg/Nm ³	1.1	NR	0.7	Periodic
	VOC	mg/Nm ³	398	NR	0.3	Continuous
	HCl	mg/Nm ³	1.8	NR	1.6	Periodic
	HF	mg/Nm ³	0.8	NR	0.06	Periodic
	Hg	mg/Nm ³	0.0007	NR	0.0005	Periodic
	Pb, Co, Ni, Se, Te	mg/Nm ³	0.005	NR	0.003	Periodic
	PCDD/F	ng/Nm ³	NR	< 0.1	NR	Periodic

NR = Not reported.
Source: [393, Austria 2012]

Cross-media effects

- Increase in energy use.
- Waste could be generated if the collected dust cannot be recycled.

Technical consideration relevant to the applicability

General applicable.

Economics

No information provided.

Driving force for implementation

- Environmental legislation requirements.
- Recovery of raw material.

Example plant

All plants in the EU-28.

Reference literature

No reference literature provided.

4.3.4.7 Techniques to reduce the emissions to air of organic carbon from the melting furnace

Description

The techniques to consider are:

- afterburner;
- internal burner system.

Technical description

Depending on the type of scrap, especially its organic contaminants, flue-gas from furnaces may contain various organic compounds, expressed as total volatile organic carbon (TVOC). Afterburners or internal burner systems aim to maintain a suitable temperature and can further combust organic compounds in the flue-gas and convert them into CO₂, H₂O and HCl.

Afterburner

The afterburner system consists of a refractory chamber with one or more burners. The chamber design must consider the residence time of the gases and this parameter strictly depends on the composition of organic compounds, in particular the chlorine content.

Internal burner system

In the internal burner system, the exhaust gas stream is directed through the burner flame and organic carbon is also converted with free oxygen to CO₂. It is usually applied in a two-chamber furnace. In the first chamber (charging chamber), the pyrolysis of the organic materials takes place, then the fume goes into the second chamber (heating chamber) where the organic compounds are burnt with oxygen.

Achieved environmental benefits

- Reduction of organic compounds, including VOCs, CO and PCDD/F.
- Reduction in energy use when the internal burner system is applied.

Environmental performance and operational data

The average of periodic measurements (or periodic data reporting) in one year ranges from < 1 mg/Nm³ to 26 mg/Nm³.

The TVOC emissions, measured continuously, in a secondary aluminium plant are reported in the Table 4.68 below.

Table 4.68: TVOC emissions, measured continuously, in a secondary aluminium plant

Pollutant	Emissions values				Average
	Minimum	Average	95th percentile	Maximum	
TVOC (mg/Nm ³)	0.1	16.34	45.85	98	Half-hourly
	2.4	17.28	29.8	42.5	Daily

Figure 4.14 below shows the emissions of TVOC according to the data provided [378, Industrial NGOs 2012].

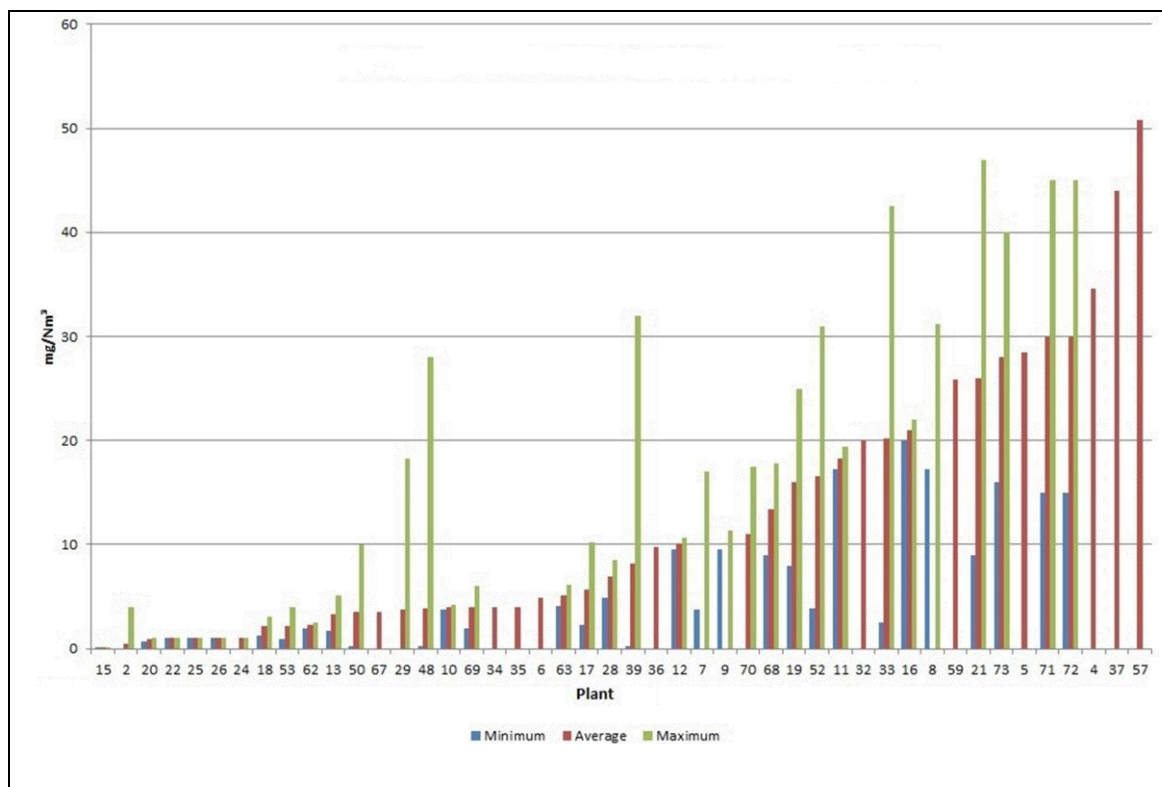

Figure 4.14: TVOC emissions in secondary aluminium production plants

Only 28 % of the secondary aluminium plants measure TVOC emissions continuously.

Cross-media effects

Afterburner

- Increase in energy use.
- Increase in NO_x and CO₂ emissions.

Internal burner system

No cross-media effects were reported.

Technical considerations relevant to applicability

Generally applicable.

Economics

No information provided.

Driving force for implementation

- Environmental regulation requirements.
- Reduction in energy use when the internal burner system is applied.

Example plants

Plants in AT, DE and IT.

Reference literature

No reference literature provided.

4.3.4.8 Techniques to reduce the emissions to air of acid gases and organic carbon, including PCDD/F

Description

The techniques to consider are:

- lime or sodium bicarbonate injection;
- activated carbon injection.

Technical description

A dust filter cannot remove gaseous components from the waste gas stream itself, but it can be used for a surface reaction if absorbent agents are mixed in with the flue-gas. Absorbents are injected in order to neutralise the acid components and chlorine by chemical reaction and to absorb organic compounds such as PCDD/F. Activated carbon and calcium carbonate (CaCO_3) or NaHCO_3 are the commonly used absorbents in secondary aluminium plants. The activated carbon is used to remove and absorb PCDD/F and metals, if present. The reactions with different acid compounds are:

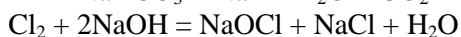
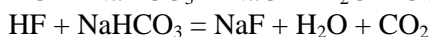
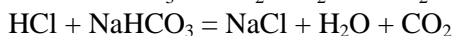
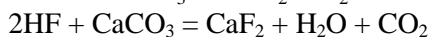
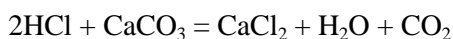

The quantity of absorbents used depends on the type of scrap processed and the thorough mixing of the absorbents with the waste gas. On average, 0.5–1 g/m^3 of acid absorbents and 0.1–0.2 g/m^3 of activated carbon are used.

One example of other mixtures is the mixture of calcium hydroxide (Ca(OH)_2), calcium carbonate (CaCO_3) and a group of mineral reagents.

The absorbents are usually injected into a reactor vessel by a screw conveyor, with the feed rate controlled via a speed-controlled rotary lock or by a pneumatic feed system. After passing the reactor, the waste gas goes on to the filter.

In some plants, when the quantity of organic contaminants is relatively high in the input material, i.e. scrap, an afterburner is used before the aforementioned agents are injected into the waste gases, to allow the effective reduction of the PCDD/F emission.

Achieved environmental benefits

Reduction of organic compounds, such as PCDD/F, and acid gases (HCl, HF) emissions.

Environmental performance and operational data

Emission levels achieved with injection of lime/ NaHCO_3 /activated carbon or other mixtures of absorbent are as follows:

PCDD/F:

Average based on 6-hour sampling measurement:

Range: < 0.01–0.44 ng I-TEQ/Nm³;

Data distribution: < 0.1 ng I-TEQ/Nm³: 86.5 %; 0.1–0.2 ng I-TEQ/Nm³: 5.4 %;

0.2–0.44 ng I-TEQ/Nm³: 8.1 %.

HCl:

When rotary furnaces are used, the HCl emissions come from the salt in combination with some moisture. Here, the HCl emissions are usually lower than 10 mg/Nm³. They are reduced using lime or sodium bicarbonate injection.

When impellers or porous rocks are used for chlorination, the HCl values are usually < 5 mg/Nm³. Ceramic lances create much higher HCl emissions and should be phased out.

Average based on periodic measurements, usually half- or one-hour measurements carried out once or twice a year:

Range: < 1–8 mg/Nm³;

Max. value: 16.3 mg/Nm³.

HF:

Average based on periodic measurements, usually half- or one-hour measurements carried out once or twice a year:

Range: < 0.1–2.3 mg/Nm³;

Max. value: 2.5 mg/Nm³.

Figure 4.15, Figure 4.16, Figure 4.17, Figure 4.18 below show the emissions of HCl, Cl₂, HF and PCDD/F according to the data provided [378, Industrial NGOs 2012]

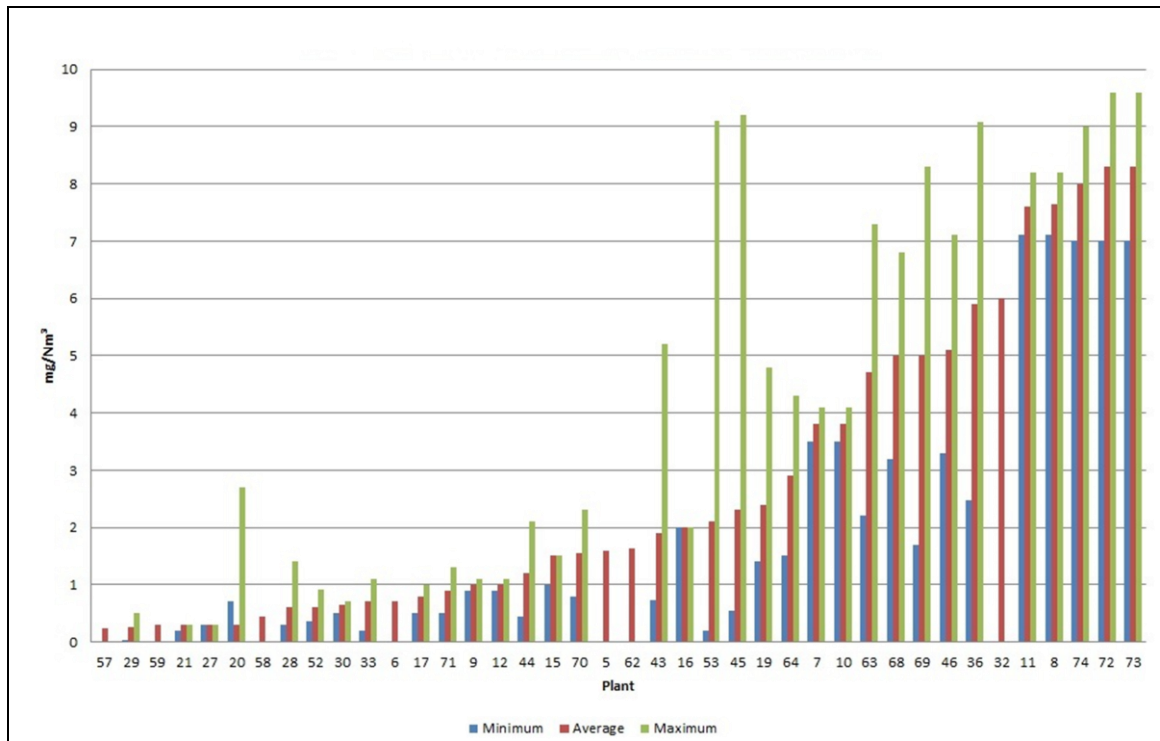

Figure 4.15: HCl emissions in secondary aluminium production plants

One plant reported continuously monitoring HCl emissions.

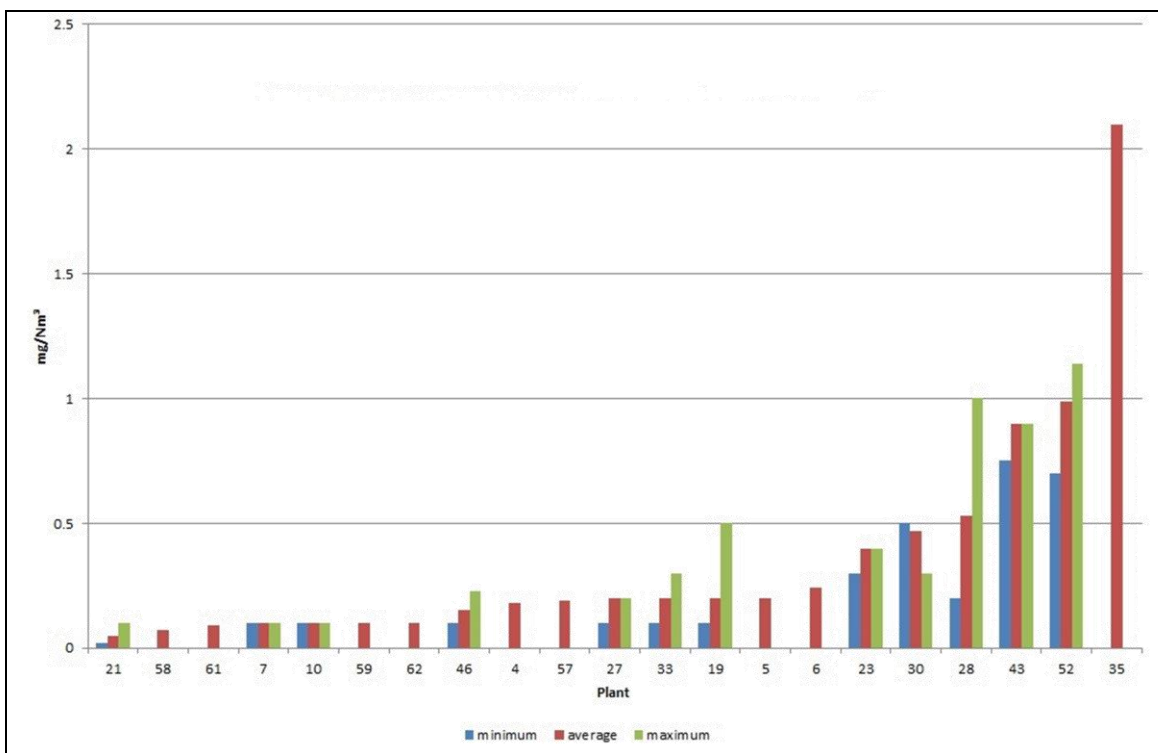

Figure 4.16: Cl_2 emissions in secondary aluminium production plants

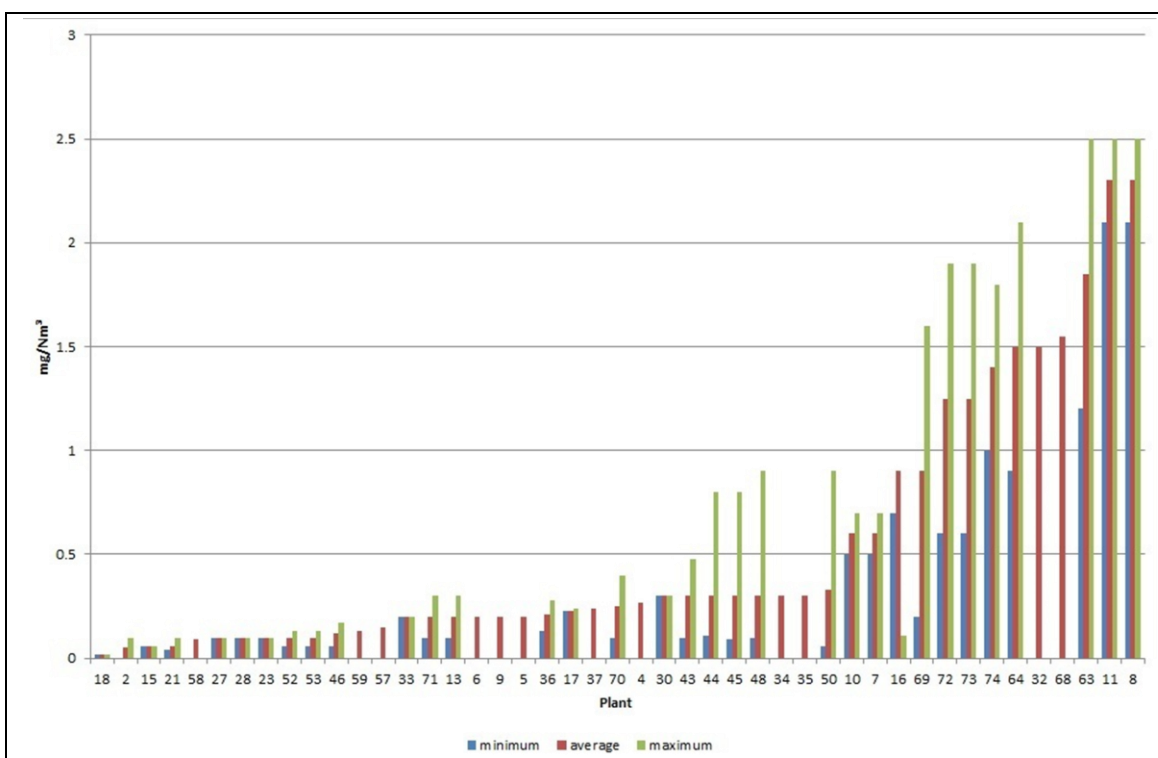

Figure 4.17: HF emissions in secondary aluminium production plants

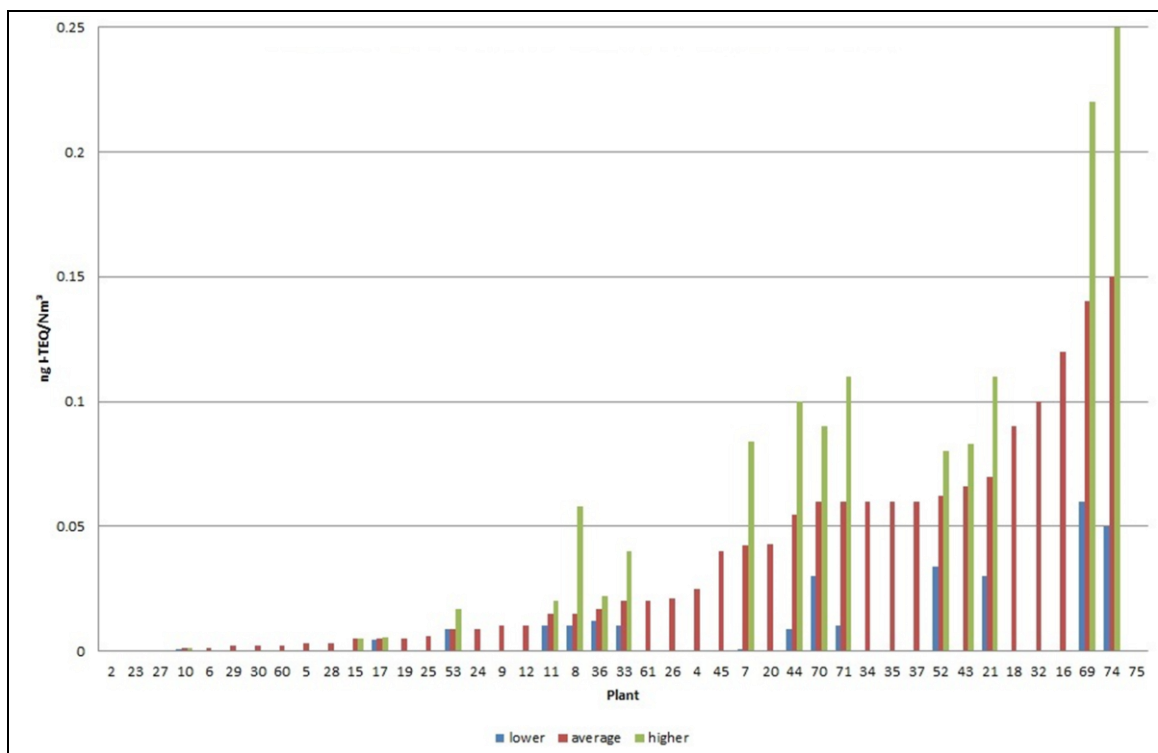

Figure 4.18: PCDD/F emissions in secondary aluminium production plants

Cross-media effects

Use of additives, and waste may be produced if the collected dust cannot be reused.

Technical considerations relevant to applicability

Generally applicable.

Economics

No information provided.

Driving force for implementation

Environmental regulation requirements.

Example plants

Plants in AT, DE, ES, IT and UK.

Reference literature

[298, Mensink 2005], [394, Schmitz 2006]

4.3.4.9 Techniques to prevent and reduce emissions to air from molten metal treatment in secondary aluminium production

Description

The techniques to consider are:

- control of the refining process and use of a mixture of chlorine with inert gas;
- dry scrubber using lime or sodium bicarbonate as the absorbent agent;
- supply the liquid metal for direct moulding.

Technical description

Molten metal is refined to remove gases and other metals. In the refining, a mixture of chlorine or other treatment agents with inert gas is used, and chlorine, HCl and HF are emitted.

Control of the refining process and use of a mixture of chlorine with inert gas

If an excess of chlorine is used, it could be emitted as aluminium chloride and this could hydrolyse in contact with air to produce HCl. To prevent or reduce this, good control of the process is necessary, as well as the use of a mixture of chlorine with an inert gas instead of pure chlorine.

Dry scrubber using lime or sodium bicarbonate as the absorbent agent

The injection in the flue-gas before the bag filter of lime or sodium bicarbonate is used to reduce acid emissions.

Supply the liquid metal for direct moulding

The metal is supplied in liquid form directly to the customer in order to economise on the energy needed to remelt the aluminium alloy.

Achieved environmental benefits

Control of the refining process and use of a mixture of chlorine with inert gas

Prevention of acid emissions.

Dry scrubber using lime or sodium bicarbonate as the absorbent agent (see Plant 19)

Reduction of acid emissions.

Supply the liquid metal for direct moulding

- Reduction of emissions to air.
- Raw material savings.

Environmental performance and operational data

In the table below, emission values for HCl, Cl₂ and HF are shown.

Table 4.69: HCl, Cl₂ and HF emissions from molten metal treatment in secondary aluminium production

Plant	Techniques	Pollutant	Values (mg/Nm ³)			Monitoring frequency
			Min.	Avg.	Max.	
19	Lime injection	Dust	0.5	0.6	0.9	3 times a year
		HCl	1.4	2.4	4.8	
		Cl ₂	0.1	0.2	0.5	
28	Lime injection	Dust	< 0.3	< 0.3	< 0.3	3 times a year
		HCl	< 0.3	0.6	1.4	
		Cl ₂	< 0.2	0.53	1	
		HF	< 0.1	< 0.1	< 0.1	
German	Lime injection	HCl	0.12	NR	0.56	4 times a year
		Cl ₂	0.17		0.3	
		HF	0.19		0.2	3 times a year

NB: NR = Not reported.
 Source: [378, Industrial NGOs 2012], [385, Germany 2012]

The production of semis products implies the remelting of the aluminium ingots in a furnace, with the associated energy consumption, metal loss and pollutant emissions. The energy saved by supplying liquid metal for direct moulding is around 1 MWh/t of secondary aluminium

produced. The reduction of diffuse and channelled emissions for the gas remelting furnace is around 80 g/t Al for dust and for CO₂ emissions it is up to 300 kg CO₂/t Al.

Cross-media effect

Control of the refining process and use of a mixture of chlorine with inert gas

No information provided.

Dry scrubber using lime or sodium bicarbonate as the absorbent agent (see Plant 19)

Use of additives, and waste may be produced if the collected dust cannot be returned to the process.

Supply the liquid metal for direct moulding

No information provided.

Technical consideration relevant to applicability

Control of the refining process and use of a mixture of chlorine with inert gas

Generally applicable.

Dry scrubber using lime or sodium bicarbonate as the absorbent agent

Generally applicable.

Supply the liquid metal for direct moulding

The customer's moulding site must be no more than four to five hours from the liquid-producing site.

Economics

The economic benefit of supplying the liquid metal for direct moulding is around EUR 80/t Al.

Driving force for implementation

Environmental regulation requirements.

Example plant

Plant 19, Plant 28, France and Germany.

Reference literature

[296, EAA, OEA 2012], [395, France 2013]

4.3.4.10 Techniques to prevent and reduce emissions from remelting

Description

The techniques to consider are:

- use of uncontaminated aluminium material;
- optimisation of combustion conditions for the reduction of dust;
- bag filter.

Technical description

The dust content in the flue-gas fluctuates across a broad range and is essentially affected by the type and scale of impurities in the metal-containing feedstock and the associated process steps (charging, melt treatment, skimming). If clean scraps or ingot materials are used and the melting performance is poor, the specific dust fractions are practically negligible and do not call for any secondary measures [357, VDI 1998]

Achieved environmental benefits

Reduction of emissions to air.

Environmental performance and operational data

Recent studies on aluminium smelting plants show that if block materials and clean recirculated scraps are used in the hearth furnaces, low dust emission values can be achieved, even without secondary measures. Brief emission peaks occur, essentially during the chlorination and skimming processes (see Section 4.3.4.9) and during metal combustion (direct oxidation of the metal in a narrowly delimited part of the furnace). These studies conclude that the avoidance of metal combustion and the dedusting of a partial waste gas flow represent an ecologically and economically sensible variant with respect to the process's overall balance sheet [357, VDI 1998].

Emissions from Site 1 are presented in the following table. Site 1 has four remelting plants and one holding furnace. The furnaces use natural gas as a fuel and only uncontaminated scraps are melted. No end-of-pipe techniques are used to reduce the dust emissions.

Table 4.70: Dust emissions from Site 1

Plant		Flow rate (maximum) (Nm ³ /h)	Dust		
			Value (mg/Nm ³) ⁽¹⁾		Year
1	Remelting + casting	14 000	Maximum	9	2008
		NR	Minimum	< 0.2	2011
2	Remelting + casting	7650	Maximum	17	2008
		NR	Minimum	1	2009
3	Remelting + casting	12 000	Maximum	14	2008
		NR	Minimum	1.5	2009
4	Remelting	NR	Maximum	2.2	2011
		NR	Minimum	1.1	2010
5	Holder	NR	Maximum	15	2011
		NR	Minimum	1.4	2010

⁽¹⁾ Emissions are monitored every 6 months (sampling period of 3 hours).
NR = Not reported.
Source: [378, Industrial NGOs 2012]

Emissions from Site 2 are presented in Table 4.71. The furnaces use natural gas as a fuel and only uncontaminated scraps are melted. No end-of-pipe techniques are used to reduce the dust emissions.

Table 4.71: Dust emissions from Site 2

Plant		Flow rate (maximum) (Nm ³ /h)	Year	Dust (maximum)		Average
				mg/Nm ³	kg/t	
1	3 melting furnaces + 3 holding furnaces	102 000	2009	12.7	0.0076	Maximum value: Average of 3 samples of 20 minutes each
2	3 melting furnaces + 3 holding furnaces	61 300	2009	12.7	0.0038	Maximum value: Average of 3 samples of 20 minutes each
		NA	2012	6.53	NA	Full cycle monitoring
3	Melting furnace + holding furnace	40 000	2007	14.7	0.0047	Maximum value: Average of 3 samples of 20 minutes each
		–	2012	20.08	NA	Full cycle monitoring

NB: NA = Not available.
Source: [378, Industrial NGOs 2012]

Emissions from Site 3 and Site 4 are presented in the next table. Both sites use natural gas as a fuel and uncontaminated scraps are melted. In order to reduce dust emissions, Site 3 uses a bag filter.

Table 4.72: Dust emissions from Site 3 and Site 4

Site	Flow rate (maximum) (Nm ³ /h)	Year	Dust (maximum)		Average
			mg/Nm ³	kg/t	
3	NA	2012	1.4	NA	Full cycle monitoring
4	Melting furnaces + holding furnaces	2009	12	0.035	Sampling period of 1 hour
	NA	2009	4	0.013	Sampling period of 1 hour
	NA	2009	NA	0.007	Sampling period of 1 hour

NB: NA = Not available.
 Source: [378, Industrial NGOs 2012]

Cross-media effect

Use of a bag filter results in an increase in energy use.

Technical considerations relevant to applicability

Generally applicable.

Economics

No information provided.

Driving force for implementation

Environmental legislation requirements.

Example plants

Sites 1, 2, 3 and 4.

Reference literature

[357, VDI 1998]

4.3.4.11 Techniques to prevent and reduce emissions to air from skimmings/dross

Description

The techniques to consider are:

- cooling of skimmings/dross in sealed containers under inert gas;
- cooling of skimmings/dross in sealed containers;
- compaction of skimmings/dross with an air extraction and dust abatement system;
- prevention of wetting of the skimmings/dross.

Technical description

Skimmings/dross are formed by the reaction products of the purging treatment and the oxidation of molten aluminium on the surface of the melt. They are skimmed off from the metal surface before the casting. Skimmings/dross are treated to recover the aluminium content as soon as they are produced, to reduce the emission and to reduce the metal lost through oxidation. Sealed containers or dross presses, nitrogen or argon blanketing or compaction can be used to minimise the emission and the further oxidation of the skimmings/dross [103, COM 1998]

Skimmings/dross are either processed locally to recover aluminium or recycled by the secondary aluminium industry (see Section 4.2.4.3).

Achieved environmental benefits

- Reduction of emissions to air.
- Reduction of raw material losses due to oxidation.

Environmental performance and operational data

No data reported.

Cross-media effects

No information provided.

Technical considerations relevant to applicability

Generally applicable.

Economics

No information provided

Driving force for implementation

- Environmental regulation requirements.
- To increase recovery of raw material.

Example plants

No information provided.

Reference literature

[103, COM 1998]

4.3.4.12 Techniques to prevent or reduce the production of salt slag

4.3.4.12.1 Use of metal pumping or a stirring system to improve efficiency and reduce salt usage

Description

This technique uses a reverberatory furnace (also called a chamber or well furnace) with a side well, a charge well and a metal-pumping system. Mechanical or electromagnetic stirring transfers heat from the main hearth to the charge well; the absence of a flame reduces the oxidation of metal, and so this process is not dependent on the use of salt.

Technical description

The stirring of the contents using electromagnetic systems situated below the furnace is also used to improve efficiency; in these cases, the total contents of the furnace are stirred. The use of a side well allows fine aluminium particles to 'dissolve' in the circulating molten metal, and reduces losses due to oxidation (see Figure 4.19).

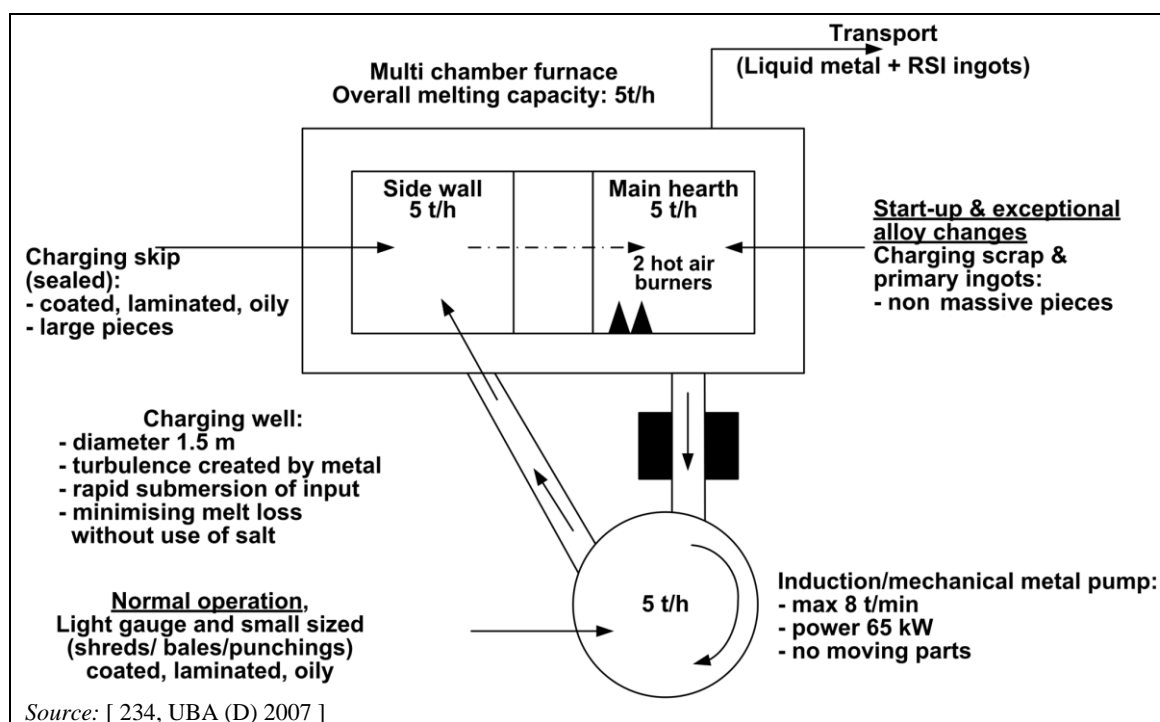

Figure 4.19: An example of a metal-pumping system

The use of a charge preheating chamber is highly effective in combination with stirring systems. Hydrocarbons are emitted during charge preheating as the contents are pyrolysed from the scrap. The gases produced are directed to the furnace burner system, which destroys the hydrocarbons and utilises the energy content for melting.

Achieved environmental benefits

- Potential elimination of salt cover and a greater range of raw materials than simple reverberatory furnaces.
- Improved capture of furnace gases.
- A reduction in the amount of waste produced that requires treatment, and the associated reduction in energy usage and emissions from the furnace.

Environmental performance and operational data

The operational data are included in the description. There is an improvement in metal yield and a reduction in energy costs.

Cross-media effects

No information provided.

Technical considerations relevant to applicability

This technique is applicable to new and upgraded reverberatory furnaces that can be adapted to use stirring.

Economics

Costs in 1997 for a 30-tonne furnace and electromagnetic pumping system were EUR 2.73 million. The estimated cost savings (energy, improved yield, flux savings and treatment savings) were EUR 1.26 million per year with a payback time of 2.2 years.

The cost of the pumping system and charge well was ~ EUR 456 000.

Driving force for implementation

- Reduction of salt slag use.

- Improved yield of metal.
- Improved quality of metal.

Example plants

Plants in UK, BE, DE, AT, ES and IT.

Reference literature

[119, McLellan 1998], [120, McLellan 1998], [232, COM 2008], [256, Winter 2007].

4.3.4.12.2 Technique to improve efficiency and minimise the use of salt cover**Description**

The technique to consider is the use of a tilting rotary furnace, to achieve both adequate cover of the melt with less use of salt and mixing to remove impurities.

Technical description

The tilting rotary furnace requires less salt than the rotary drum. The salt factor, i.e. kg of salt per kg of non-metallic product, for a rotary drum furnace is 1.8, whereas the salt factor for a tilting rotary furnace is from 0.1 to 0.5 (depending on the characteristics of the raw materials). The small amount of salt is possible due to the mode of operation; in the rotary drum furnace the salt slag has to be removed from the furnace from the slag hole while in the tilting rotary furnace the salt slag is removed by tilting the furnace. Also, while the furnace is in operation, the furnace is tilted in such a way as to have a lower surface that needs to be covered.

Achieved environmental benefits

- Reduction in the amount of salt slag produced.
- Reduction of the amount of waste produced that requires treatment, and consequently the associated reduction in energy and emissions from treatment processes [256, Winter 2007].

Environmental performance and operational data

- Reduction of the salt usage factor to < 0.5 kg salt per kg of non-metallic raw material.
- Improvement in the recovery of aluminium.
- Extension of the range of raw materials that can be used.

Technical considerations relevant to applicability

The technique is applicable to new furnaces only, as it cannot be retrofitted to existing/old furnaces. There are size restrictions, i.e. very small particles will be oxidised and large items will not fit in the furnace, and therefore the technique is not applicable for all feedstocks.

Cross-media effects

No information provided.

Economics

Cost savings from no longer needing to purchase and treat salt allow the technique to be economically beneficial.

Driving force for implementation

- Reduction of salt slag production.
- Improved yield of metal.

Example plants

Plants in AT, DE, ES, FR, IT and UK.

Reference literature

[142, Boin, U. et al. 1998], [256, Winter 2007]

4.3.5 Salt slag

4.3.5.1 Full recycling of salt slag

Description

The full recycling of salt slag is a combination of different physico-chemical steps that exploit different material characteristics of the three main salt slag components (aluminium, aluminium oxide and salt).

Technical description

In the full recycling processes, the salt slag is completely recovered to marketable products without producing any residues and it is also possible to avoid the production of waste water.

The three main salt slag components, in typical salt slag, are:

- metallic aluminium (4–10 wt-%), which is almost insoluble in water; during crushing it shows distinct ductile material behaviour;
- oxidic components (35–75 wt-%), which are insoluble in water and are brittle; they form a fine dust when crushed;
- alkaline chlorides (20–55 wt-%), which are very soluble in water; they are brittle and can be crushed.

The large blocks of salt slag are crushed and ground down step by step to a manageable size and then sieved to recover metallic aluminium granules (typically up to 10 %). The finely crushed material is then dissolved in water. The alkaline chlorides enter the solution and form salt brine. The coarse aluminium granulates are separated from the insoluble fraction consisting of metallic oxides (predominately alumina) and fine metallic aluminium powder in a dry and wet sieving system. The brine is filtered, removing the insoluble oxides, and the solution is then sent for evaporation and crystallisation, during which the original sodium and potassium chlorides are recovered. These chlorides are reused as fluxes in the aluminium smelting process.

During the recovery process, hydrogen, ammonia, hydrogen sulphide, phosphane and methane, as well as dust, develop in different plant sections. They are collected and treated either thermally to recover energy or in a wet system to convert ammonia to ammonia sulphate, which can be recovered for sale [267, BEFESA 2008]

A typical flowsheet of the full salt slag recycling process is shown in Figure 4.20.

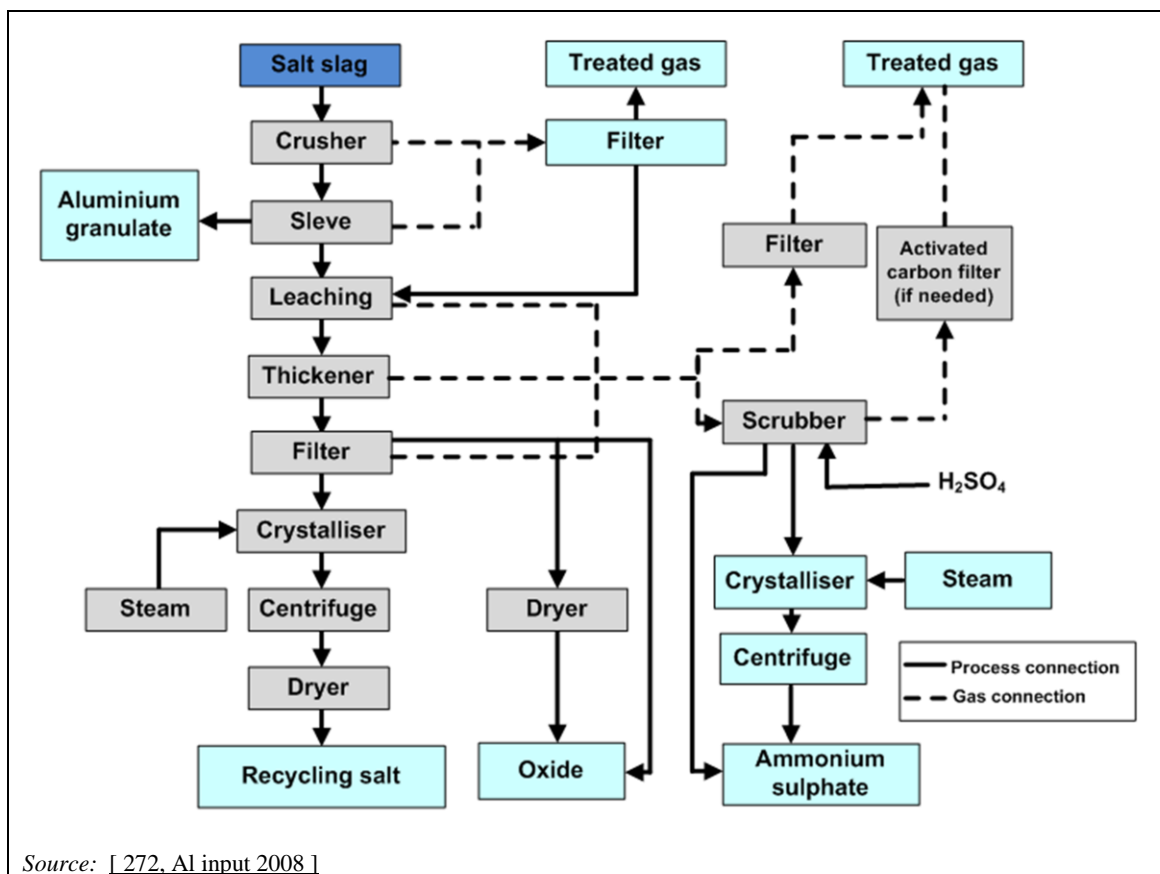

Figure 4.20: An example of the full salt slag recycling process

The residual metal oxides comprise aluminium, magnesium and calcium oxides (up to 75 % Al_2O_3), as well as silicon oxides and also sulphates, nitrates and chlorides. By reducing these anions to manageable values in further process steps (washing and drying), a fine aluminium oxide is produced that can be sold to the brick, ceramics, clay, cement and mineral wool industries to substitute natural material. Additional washing or calcining processes can be used for the production of special quality products. The brine solution from the washing can be returned to the dissolution stage. Thus a complete recovery of the materials present in the salt slag is achieved.

There are some variations in the processes used (e.g. mechanical pretreatment, leaching stage, waste gas treatment, solid-liquid separation). In some plants the grinding system is dry hence there is no gaseous emission, while in others the last grinding stage is carried out using water. All the grinding installation equipment is sealed to prevent diffuse dust emissions.

Achieved environmental benefits

- Prevention of landfill.
- Recovery of salt for reuse and of the aluminium portion for recycling, and the production of alumina for sale and ammonia sulphate for use as fertiliser. The only process waste is activated carbon, if used for the abatement of the emissions to air.
- The full recycling processes are waste-water-free.

Environmental performance and operational data

The percentages of the components that are recovered are:

- 100 % of the aluminium metal;
- 100 % of the soluble salt;
- 100 % of the insoluble aluminium oxides.

Off-gas treatment using activated carbon might have a significant advantage in eliminating phosphane compared to afterburning, but the disposal or treatment of spent carbon should be considered. Crushing operations can be very dusty when not carried out under adequate off-gas extraction.

Achieved emission values are reported in Section 4.3.5.3 for various abatement techniques.

Cross-media effects

- Increase in energy use.
- Increase in emissions to air of ammonia, phosphane, hydrogen sulphide and dust.

Technical considerations relevant to applicability

Generally applicable.

Economics

The treatment costs are similar to disposal costs but avoid 'future liability'.

Driving force for implementation

Recovery of all of the components of the slag, and the prevention of landfill.

Example plants

Plants in DE, ES, FR, IT and UK.

Reference literature

[113, ALFED 1998], [142, Boin, U. et al. 1998], [202, Fundación Entorno, Empresa y Medio Ambiente 1999], [233, COM 2008], [234, UBA (D) 2007], [267, BEFESA 2008], [312, VDI 2008]

4.3.5.2 Partial recycling of salt slag

Description

The process follows the same stages as the full recycling process, but not all of the components of the salt slag are recovered. The aluminium and potassium chloride are recovered. The oxide portion and the granulation brine are used for recultivation of potash tailings piles.

Technical description

The process has three steps, two of which are the same as for the full salt slag recycling process.

1. Dry step: crushing and screening, and separation of the solid aluminium drops contained in the slag. This is necessary as these do not disintegrate during the milling like the brittle salt slag.
2. Wet step: transformation with aqueous dissolution and absorption of the emerging gases. This happens in two steps: alkaline (NH_3 , H_2) and acidic (H_2S , PH_3 , H_2). From the gases, ammonium sulphate and a solution of phosphates and sulphates, used for the recultivation of the tailings pile, will be produced.
3. The potassium chloride is dissolved at about 110 °C with a hot solution saturated in halite (kitchen salt) and under-saturated in sylvite (potassium chloride). The kitchen salt remains undissolved and is filtered off. By vacuum cooling, the potassium chloride crystallises and is processed to give sellable products. The residue is used for the recultivation of potash tailings piles.

The first two steps are similar to other processes used in salt slag treatment. The difference lies in the third step.

Achieved environmental benefits

Recovery of Al and KCl.

Environmental performance and operational data

With this technique, recovery rates are:

- 95 % of the aluminium content;
- 100 % of the KCl;
- 0 % of the oxides content.

Cross-media effects

- Increase in energy use.
- Emissions of dust, ammonia, phosphane and hydrogen sulphide.
- Consumption of stabiliser (blending), which involves an increase of approximately 40 wt-% in the residue generated.

Technical considerations relevant to applicability

The applicability is limited by local conditions such as the availability of a place where potash tailings piles are recultivated.

Economics

Economic data were not available but one plant is operating. It reports a reduction in energy use compared to the full recycling process, but the salt is not recovered for reuse.

There is a cost for the disposal of any non-recycled material.

Driving force for implementation

Recovery of some components of the salt slag.

Example plants

A plant in Germany.

Reference literature

[234, UBA (D) 2007], [272, Al input 2008], [312, VDI 2008]

4.3.5.3 Techniques to reduce emissions to air from salt slag treatment

Emissions to air from the salt slag treatment process are of dust from crushing and dry milling and are usually captured and removed by a bag filter. Wet milling, on the other hand, produces gaseous emissions, mainly consisting of hydrogen, methane and ammonia, and small quantities of phosphane and hydrogen sulphide. These emissions can be removed by an activated carbon filter or a wet scrubber or sometimes they may be combusted in a suitable afterburner system. In particular, small amounts of ammonia, phosphane and hydrogen sulphide can be removed by activated carbon filters. Wet scrubbers can treat higher concentrations of ammonia. Afterburners can destroy all aforementioned gases. Each of these techniques is described separately below.

4.3.5.3.1 Dust filters for crushing and dry milling of salt slag**Description**

The techniques to consider are:

- enclosed equipment or extraction hood connected with the gas extraction system;
- bag filter.

Technical description

Dust is only emitted from salt slag during dry crushing and dry milling. These operations may use pick hammers, jaw crushers, impact crushers, hammer mills, rod mills, ball mills and roller mills for instance. These machines can be completely enclosed or equipped with suction hoods and connected to suitable air exhaustion systems driven by suction fans. Enclosed system and suction hoods can also be applied to conveying equipment like belts and screws, and to the feeding and outlet points, as well as to the interfaces between them.

From the suction points, the airborne dust is led by ducts to bag filters where the dust is separated. The separated dust falls off the filter prior to being collected in troughs or containers, and is then conveyed to silos. From the silos, the dust is sent to any other subsequent process step of the salt slag treatment process.

Having passed the filters, the clean air is freed from most of the dust, except for some minor amounts of very fine grains that might slip through the bags, and is therefore released through the stack to the atmosphere.

Achieved environmental benefits

Enclosed equipment or extraction hood connected with the gas extraction system

- Reduction of diffuse emissions.
- Prevention of odour emissions caused by ammonia.

Bag filter

Reduction of dust emissions.

Environmental performance and operational data

Dry dust collection systems like bag filters as described above can lower the dust load of off-gases from about 1–50 g/Nm³ in the raw gas down to below 5 mg/Nm³ in the clean gas.

In cases of very high levels of dust in process gases (> 50 g/Nm³), bag filters could be combined with a pre-separation stage (cyclone).

Table 4.73 shows the dust emissions from the crushing and dry milling stage.

Table 4.73: Dust emissions from the crushing and dry milling of salt slag

Plant	Technique	Pollutant	Values (mg/Nm ³)			Periodic measurement
			Min.	Avg.	Max.	
Italy	Bag filter	Dust	NR	4.8	NR	Once a year
Germany	Bag Filter	Dust	1	NR	2	NR

NB: NR = Not reported.
 Source: [385, Germany 2012] [396, Italy 2012]

Cross-media effects

Increase in energy use.

Technical considerations relevant to applicability

Generally applicable. A bag filter though is usually not able to remove gaseous impurities like ammonia from raw off-gases. Bag filter structure, particularly the bags, may even react with any ammonia, moisture, etc. that may be contained in the raw gases. Moisture, like airborne humidity for instance, might cause accretions and then block the bags of the filter. Therefore, they are not recommended for use to dedust wet process gases.

Economics

The use of the bag filter requires:

- power consumption: EUR 0.55/t Al;
- operating costs: EUR 0.18/t Al.

Driving force for implementation

Environmental and health regulation requirements.

Example plants

Plants in DE, ES, IT and UK.

Reference literature

[296, EAA, OEA 2012]

4.3.5.3.2 Activated carbon filter

Description

The technique to consider is the use of a wet acid scrubber (see Section 2.12.5.2.2), followed by an activated carbon filter (see Section 2.12.5.2.3) to reduce the emissions to air from the wet milling and dissolution process.

Technical description

During the wet milling and dissolution process, the fine salt slags react with water and produce mainly hydrogen, methane and ammonia, and small quantities of phosphane and hydrogen sulphide. The whole system is ventilated in an excess of air to keep the gas concentration below the ignition limit. The gas is extracted from the outlet of the mill and reaction tanks, cooled down to the correct temperature (about 70 °C) and washed through a wet acid scrubber (see the next section) to remove the ammonia, and then finally filtered in activated carbon filters to remove the hydrogen sulphide and phosphane before releasing it to atmosphere.

Activated carbon

Activated carbon, also called activated charcoal, is a form of carbon that has been processed to make it extremely porous and thus have a very large surface area available for adsorption or chemical reactions.

The off-gas is heated to prevent water condensation within the adsorber. A heat exchanger with saturated vapour keeps the flow temperature up to 70 °C. The system consists of four adsorbers (carbon vessels) that work two by two in parallel. The gas flow is sent to two adsorbers while the other two are in regeneration. The off-gas is monitored to control the gaseous emissions of phosphane and hydrogen sulphide.

Achieved environmental benefits

Reduction of emissions of H₂S (hydrogen sulphide) and PH₃ (phosphane).

Environmental performance and operational data

Environmental emissions

The PH₃ value in the inlet ranges between 25 ppm (19 mg/Nm³) and 75 ppm (55 mg/Nm³), with an average of 50 ppm (37 mg/Nm³). The off-gas concentration is less than 0.1 ppm.

The H₂S value in the inlet is, on average, 20 ppm (15 mg/Nm³). The off-gas concentration is less than 0.1 ppm. The inlet and outlet values are regularly monitored.

Table 4.74 shows the emissions reported by a plant in Germany.

Table 4.74: Emissions from the wet mill after the activated carbon filter

Plant	Technique	Pollutant	Values (mg/Nm ³)		
			Min.	Avg.	Max.
K + S	Activated carbon filter	PH ₃	0.1	NR	0.42
		H ₂ S	0	NR	0
		NH ₃	0	NR	5
NB: NR = Not reported. Source: [360, Germany 2013]					

Residues

The activated carbon is regenerated. When it loses its activity and it is not possible to regenerate it any more, it has to be replaced. The used carbon is then sent to a waste management company.

Cross-media effects

- Increase in energy use.
- Production of waste.

Technical considerations relevant to applicability

This technology is applied for salt slag processing using a wet milling system. A dry milling system does not need activated carbon filters; the exhaust gases are treated in a combustion system (afterburner).

Economics

The cost per tonne of salt slag is between EUR 0.5 and EUR 1.

Driving force for implementation

Environmental regulation requirements.

Example plants

Plants in Germany.

Reference literature

[296, EAA, OEA 2012]

4.3.5.3.3 Wet acid scrubber**Description**

In the process with dry milling, this technique (see Section 2.12.5.2.2) is used to clean off-gases from the salt recovery process (excluding the milling). In the process with wet milling, the wet scrubber is used to clean the off-gas from the wet milling and dissolution process.

Technical description

A wet scrubber uses an acid media (H₂SO₄) to clean gaseous emissions (especially ammonia).

Achieved environmental benefits

- Reduction of the basic emissions to air from the salt recovery process (e.g. ammonia).
- There is no water discharge.
- Sulphate ammonia solution is produced and can be sold (i.e. as fertiliser).

Environmental performance and operational data

The performance of the technique is mostly dependent on the following parameters:

- pH value of the cleaning solution;
- pressure drop.

Typical clean gas emission levels are:

- ammonia: 1–20 mg/Nm³;
- phosphane: 0.2–1 mg/Nm³;
- hydrogen sulphide: 0.2–5 mg/Nm³.

pH control and pressure drop devices are used to control and maintain the technique efficiency.

Critical parameters for correct design and operation are:

- relative water and gas speed;
- water and gas volume;
- acid media and gas pollutant concentration;
- contact surface between air and liquid phases.

Cross-media effects

Increase in energy use.

Technical considerations relevant to applicability

Generally applicable.

Economics

No information provided.

Driving force for implementation

Environmental regulation requirements.

Example plants

Four plants in Italy.

Reference literature

[296, EAA, OEA 2012]

4.3.5.3.4 Afterburner

Description

An afterburner (see Section 2.12.5.2.1) is used to clean off-gases from the hot leaching of salt slag powder.

Technical description

Afterburners employ a burner system (not necessarily used continuously). High-temperature afterburners may be used, in which the gases are typically heated to between 700 °C and 900 °C and held for a minimum of 0.5 seconds.

Achieved environmental benefits

- Prevention of gaseous emissions from the leaching process, e.g. ammonia, phosphane.
- There is no water discharge.
- Potential heat recovery.

Environmental performance and operational data

The performance of the technique is dependent on the operating temperature and residence time in order to ensure effective destruction of the materials present in the feed gas.

The fuel used in an afterburner is natural gas.

Typical clean gas emission levels are:

- ammonia: 1–20 mg/Nm³;
- phosphane: 0.2–1 mg/Nm³;
- hydrogen sulphide: 0.2–5 mg/Nm³.

Table 4.75 shows the emissions reported by plants in Germany and Italy.

Table 4.75: Emissions from the crushing, leaching, filtering and washing of salt slag

Plant	Technique	Pollutant	Values (mg/Nm ³)		
			Min.	Avg.	Max.
K + S	Thermal treatment	PH ₃	0.02	NR	0.02
		H ₂ S	< 0.7	NR	< 1.5
		NH ₃	< 0.2	NR	< 0.2
Italy	Afterburner/scrubber	PH ₃	NR	0.7	NR
		H ₂ S	NR	4.5	NR
		NH ₃	NR	5	NR
NB: NR = Not reported. Source: [360, Germany 2013]					

Before discharging to atmosphere, the gas has to be cooled (heat recovery is possible) and may be dedusted.

Temperature control devices are used for the combustion chamber and to monitor the afterburner output gas temperature. The main temperature control is for ensuring technique efficiency; the second one is for protecting the bag filter (when installed).

Cross-media effects

Potential increase in energy use if the generated heat cannot be used.

Technical considerations relevant to applicability

Generally applicable.

Economics

No information provided.

Driving force for implementation

Environmental regulation requirements.

Example plants

Three plants in Italy.

Reference literature

[296, EAA, OEA 2012]

4.3.6 Waste water

Waste water prevention and reduction systems should be implemented and cooling water should be recirculated. All waste water should be treated to remove solids and oils/tars; absorbed acid gases (e.g. sulphur dioxide, HCl) should be neutralised. The techniques listed in Sections 0 and 4.1 are the techniques to consider. In a number of installations, cooling water and treated waste water including rainwater are reused or recycled within the processes.

4.4 Emerging techniques

Red mud

Processes have been developed to use red mud and exploit its properties [247, France 2008]:

- thickening the mud to obtain a high yield with low production costs or using high-pressure filtration for construction applications such as agronomic support, road embankments, covering of controlled disposal dumps, cavity filling or in the cement industry;
- taking advantage of its colouring properties for potential pigment applications such as thermoplastic products, cement coatings, paints, and special flooring;
- adsorbing and fixing contaminants such as arsenic.

Inert anodes

Development of new carbon-free anodes would make it possible to construct a completely new electrolytic cell without consumable anodes. Oxygen would be produced at the anode instead of carbon dioxide, and emissions of PAH eliminated. The technology for this is still at the pilot plant stage and the anodes have not yet been able to [303, ENVIRONNEMENT CANADA 2008]

Wettable cathodes

The development of new cathode materials or coatings for existing cathode materials, to achieve better energy efficiency for the electrolytic process. This is at the development stage and has been tested in research cells.

Alloy separation

Techniques for the separation of aluminium scrap into different types of alloy have been tested using laser and eddy current technology. The benefits of this will be easier selection of materials for recycling and the ability to produce desired alloys in recycling plants more easily.

Salt-free dross processing

This involves dross processing for recovery of aluminium in rotary furnaces without the use of salt fluxes. The process allows for a slightly lower recovery of aluminium from the dross but the remaining skimmings are salt-free and can be utilised in steel production using electric arc furnaces. The process offers both environmental and economic benefits for both industries. The aluminium industry benefits from the conservation of salt fluxes and the generation of a by-product that can be readily recovered in another industry while the steel industry benefits from better desulphurisation, a decrease in energy consumption, improved metal yield, and replacement of similar, costly raw materials (i.e. Al/Al₂O₃-containing fluxes as deoxidisers and slag-formers).

Recovery of spent pot line

Recovery of spent pot lining in the process currently used for the full recycling of salt slag. The process is the same as the one used for the full recycling of salt slag. It consists of the dry milling of the input material, the reaction, soluble and insoluble separation, washing the insoluble fraction and evaporation of the soluble fraction. The mixture of SPL and salt slags accelerate the cyanides' oxidation during the reaction step. Soluble fluorides are removed and crystallised with the salt coming from the salt slags in the evaporation step. No solid waste or waste water is produced.

Salt-free melting of dross

The use of an electric arc furnace for salt-free melting of dross.

Recycling salt slag with electro-dialysis

Salt recovery using electro-dialysis rather than concentration.

Continuous monitoring of HF

Continuous monitoring of HF in stack emissions to allow abatement failure (in the alumina scrubber/fabric filter) to be detected.

Continuous HF measurements can also be used to control alumina additions to the dry scrubber, resulting in optimum use of the adsorption capacity of the alumina, more homogeneous alumina analysis and better control of emission peaks.

5 PROCESSES TO PRODUCE LEAD AND TIN

5.1 Applied processes and techniques

Lead and tin are produced mainly by pyrometallurgical processes, which implies the use of furnaces. Lead production can be divided into primary and secondary processes, depending on the materials treated. Primary lead smelting focuses on the conversion of lead ores and concentrates, complex secondary materials, and often some lead-acid battery scrap fractions (paste or grids) into crude lead bullion requiring further refining. Secondary lead smelting focuses mainly on recycling lead-acid battery scrap, but other residues and scrap can also be used as feed material.

The techniques used can, in some cases, be the same for secondary or mixed primary and secondary raw materials, [11, Hatch Associates Ltd 1993], [99, Hähre, S. 1998]. In other cases, secondary materials are separated and some portions, such as battery paste, are sent to other processors who deal with such material.

Tin may be recovered from the residues produced during lead production and secondary copper refining, or from the detinning of coated steel cans. Tin can also be produced from ores.

5.1.1 Primary lead

There are two basic pyrometallurgical processes available for the production of lead from lead sulphide or from mixed lead and zinc sulphide concentrates:

- sintering/smelting in a blast furnace or Imperial Smelting Furnace (ISF);
- direct smelting.

The last primary sinter and shaft furnace operating in the EU-28 switched over to the direct smelting process in October 2013.

All smelting processes may also be used for concentrates mixed with secondary raw materials.

The composition of raw materials varies depending on the concentrates and their pretreatment. The feasibility of processing certain concentrates is, among others, defined by the capability of the process to treat and recover the accompanying metals like zinc, cadmium and mercury.

Some ranges for the contents of the main constituents of lead concentrate are given in Table 5.1.

Table 5.1: Composition ranges for the main constituents of lead concentrate

Constituent	Content (%)	Constituent	Content (%)
Pb	35–90	Cu	0–5
Zn	0–15	Ni	0–1
S	0–35	Cd	0–0.2
SiO ₂	0–10	Cr	0–10
CaO	0–20	As	0–5
FeO	0–30	Hg	0–0.01
<i>Source: [11, Hatch Associates Ltd 1993], [99, Hähre, S. 1998]</i>			

5.1.1.1 Sintering/smelting using a blast furnace or Imperial Smelting Furnace

In the EU-28 there is only one site which operates an ISF furnace for the production of zinc and lead from zinc/lead concentrates. This process is described in Section 6.1.1.2.

Blast furnaces and ISFs are still in use in non-EU countries for primary lead production. Also, in some countries a combination of direct smelting and blast furnaces are used (e.g. China).

5.1.1.2 Direct smelting

In direct smelting, the sintering stage is not carried out separately. Several processes are used for the direct smelting of lead concentrates and some secondary material to produce crude lead and slag. The following processes/furnaces involve direct smelting and are used both in the EU-28 and worldwide: Ausmelt/ISASMELT (bath furnace, top submerged lance furnace) sometimes in combination with blast furnaces, Kaldo (TBRC), the QSL (bath furnace) integrated processes and electric furnaces (used for processing primary lead concentrates together with secondary materials). The Kivcet integrated process is also used and is a flash smelting process. The Ausmelt/ISASMELT and QSL furnaces take moist feed, and the Kaldo and Kivcet furnaces use dried feed [254, VDI 2004]. The processes are summarised in Table 5.2 and Table 5.3.

Other furnaces such as the Shuikoushan melting furnace (SKS bottom-blowing furnace) are not used in Europe, but are in operation elsewhere.

In all direct smelting processes, concentrates, alone or together with secondary material, are mixed with other smelting additives and fluxes to produce a fairly constant feed. The general practice is to sample and characterise the concentrates and to store individual concentrates separately, so that an optimum blend can be prepared for smelting. Feed blends can be prepared from dosing bin systems using belt weighers or loss-in-weight systems. Final mixing and homogenisation can take place in mixers, pelletisers or in the conveying and metering systems. If the smelting process requires a dry feed, a hot dryer can be used. Drying can also be used for reducing feed humidity when the moisture content is a limiting factor for the smelting process.

In all furnaces, the lead sulphide concentrates and secondary materials mix is charged directly to a furnace and then melted and oxidised. Sulphur dioxide is formed and is collected, cleaned and converted to sulphuric acid. Carbon (coke or gas) and fluxing agents are added to the molten charge. Lead oxide is reduced to lead and a slag is formed. Some zinc and cadmium are fumed off in the furnace, and their oxides are captured in the abatement plant and recovered [117, Krüger, J. 1999] [117, Krüger, J. 1999]

All processes produce a slag that contains lead, and to limit this the QSL and Kivcet furnaces incorporate an integral reduction zone to reduce the lead content of the slag to an acceptable level. Silica-based slag from the QSL furnace is accepted as construction material. The Kaldo furnace (also known as the top-blown rotary converter) uses an adjacent slag fuming furnace. The Ausmelt/ISASMELT furnace may be operated in a two-stage operation, with one furnace (batch-wise) or with two parallel furnaces (continuous) in order to treat the primary slag for use in similar applications. Otherwise, a single furnace may be operated continuously for the production of raw lead and lead-rich slag for the further treatment and recovery of lead.

Heat recovery and the conversion of sulphur dioxide into sulphuric acid are also part of these processes. Process control is based on the measurement of SO₂ in the off-gas and this leads to a delayed reaction in the sulphuric acid plant process.

Dust collected in the abatement plant is returned to the process and can be washed or leached to reduce halides [117, Krüger, J. 1999].

All of these processes took some time to be commissioned fully and achieve the anticipated throughput and conversion rates. The Kaldor is a two-stage process [11, Hatch Associates Ltd 1993], [34, UNECE 1995], [99, Hähre, S. 1998] and has been well established since 1976. The QSL and the Ausmelt/ISASMELT processes have overcome their initial problems and are now operating effectively [234, UBA (D) 2007]. The Ausmelt process in Germany can be operated with a slag reduction phase but actually produces a metallurgical lead oxide concentrate for sale. The Kivcet process has been operating successfully since 1990. [117, Krüger, J. 1999], [305, Ausmelt 2009].

Table 5.2: Summary of direct smelting processes

Process	Lead content of slag (%)	Comments
QSL	< 3	Efficient operation. Viable process
Kivcet	3–5	Successful operation
Ausmelt/ISASMELT	No slag produced ⁽¹⁾	Efficient operation. Viable process
Kaldo	2–4	Effective operation - mixed Pb/Cu
Electric furnace		Effective processing of a wide range of Cu/Pb-bearing materials

⁽¹⁾ Ausmelt in Nordenham stop the process after the oxidising step and sell the lead oxide concentrate instead of reducing the slag.
Source: [117, Krüger, J. 1999]

Table 5.3: Raw materials used in different direct smelting processes

Furnace	Raw materials	Comments
Kaldo (TBRC) (totally enclosed)	Pb concentrate and secondary material (most grades)	Dry feed, variable sulphur dioxide. Operated in a complex installation with a Cu smelter
QSL	Pb concentrate and secondary material	Moist feed
Kivcet	Cu/Pb concentrate and secondary material	Dry feed
Ausmelt/ISASMELT	Pb concentrate and secondary material	Moist, pelletised feed
Electric	Cu/Pb concentrates and secondary Cu/Pb-bearing materials	Dry feed, fine sludge-type feed materials are pelletised

5.1.2 Primary tin

Primary tin is produced using pyrometallurgical processes, by the reduction of the oxidic ore with carbon or coke. In the EU-28, there is no production of tin directly from ores.

5.1.3 Secondary lead and tin production

In secondary lead and tin production, there is a wide range of material that can be used. This can include lead- and tin-containing drosses, ashes, matte, residues and slag with broad ranges for all constituents. Scrap from lead sheet and flashings can also be used. However, lead-acid batteries represent the major proportion of feedstock for secondary lead production

5.1.3.1 Recovery of lead from lead-acid batteries

Scrap automotive and industrial batteries (automotive, motive power and standby) are the major sources of secondary lead. Directive 2006/66/EC on batteries contains a target for the recycling efficiency of lead-acid batteries of 65 % as of September 2010. The typical composition of lead-acid battery scrap is given in Table 5.4.

Table 5.4: Composition of typical lead-acid battery scrap

Component	wt-%
Lead (alloy) components (grid, poles, etc.)	25–30
Electrode paste (fine particles of lead oxide and lead sulphate)	35–45
Dilute sulphuric acid (10–20 % H ₂ SO ₄)	10–25
Polypropylene	5–8
Other plastics (PE, etc.)	2–5
Others materials (glass, etc.)	< 1
<i>Source: [377, ILA 2013]</i>	

There are two main types of processes for the recovery of lead from automotive batteries [11, Hatch Associates Ltd 1993], [34, UNECE 1995], [99, Hähre, S. 1998].

1. **Blast furnace recycling process:** After collection, used lead-acid batteries are drained of acid which, depending on local circumstances, is sold as an acid solution for aqueous leaching processes or is neutralised. The polypropylene plastic fraction may then be separated from all or part of the batteries. Drained batteries are then mixed with coke, fluxes and any other lead scraps and intermediates to make up the charge (the mix of materials) of the blast furnace. Antimonial lead bullion is produced, along with a silica-based slag and a lead-iron matte that can be recovered in a primary lead smelter [117, Krüger, J. 1999] [254, VDI 2004]. The overall process is shown in Figure 5.1.

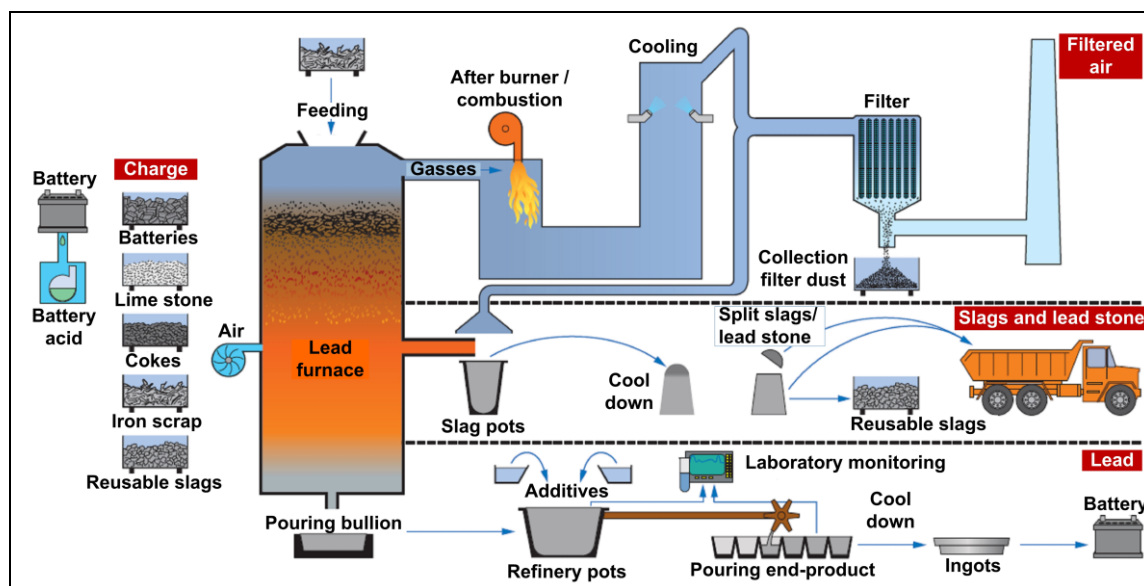

Figure 5.1: Outline of a typical shaft furnace lead-acid battery recovery process

Organic compounds in the furnace off-gases are oxidised in an afterburner and the gases are then cooled and filtered in a fabric filter. The filter dust is dechlorinated and returned to the furnace.

2. **Mechanical battery separation processes followed by smelting:** Examples of mechanical separation processes are the MA and CX (Engitec) processes. These processes are similar in principle but the technical solutions are quite different for the treatment of battery paste and sulphuric acid. In both cases, batteries are drained of acid, broken and separated into various fractions using automated proprietary equipment. Paste desulphurisation prior to smelting can reduce the quantity of slag produced and, depending on the smelting method used, the amount of sulphur dioxide released to the air [254, VDI 2004]. The process is shown in Figure 5.2.

Both the MA and CX processes use hammer-type mills to crush the whole batteries. The crushed material then passes through a series of screens, wet classifiers and filters to obtain separate fractions that contain the metallic components, lead oxide-sulphate paste, polypropylene, non-recyclable plastics and rubber and dilute sulphuric acid [103, COM 1998]. Some processes use a second milling stage before the plastic fraction is finally treated. Polypropylene is recycled as far as possible in a wide range of applications.

Battery acid contains 10–15 % sulphuric acid and some impurities. Potential further uses depend on the local situation, and several options are available to deal with the sulphur contained in the battery materials:

- alkaline leaching using an alkali salt or hydroxide solution to remove sulphates from the secondary materials prior to smelting;
- desulphurisation of the input materials;
- fixation of sulphur in the smelt phase using additives;
- treatment of the SO₂-containing gas stream by lime or sodium bicarbonate injection;
- alkaline or lime/limestone scrubber after dust filtration;
- sulphuric acid production.

These techniques are described in detail in Sections 5.3.2.5 and 5.3.4.3.

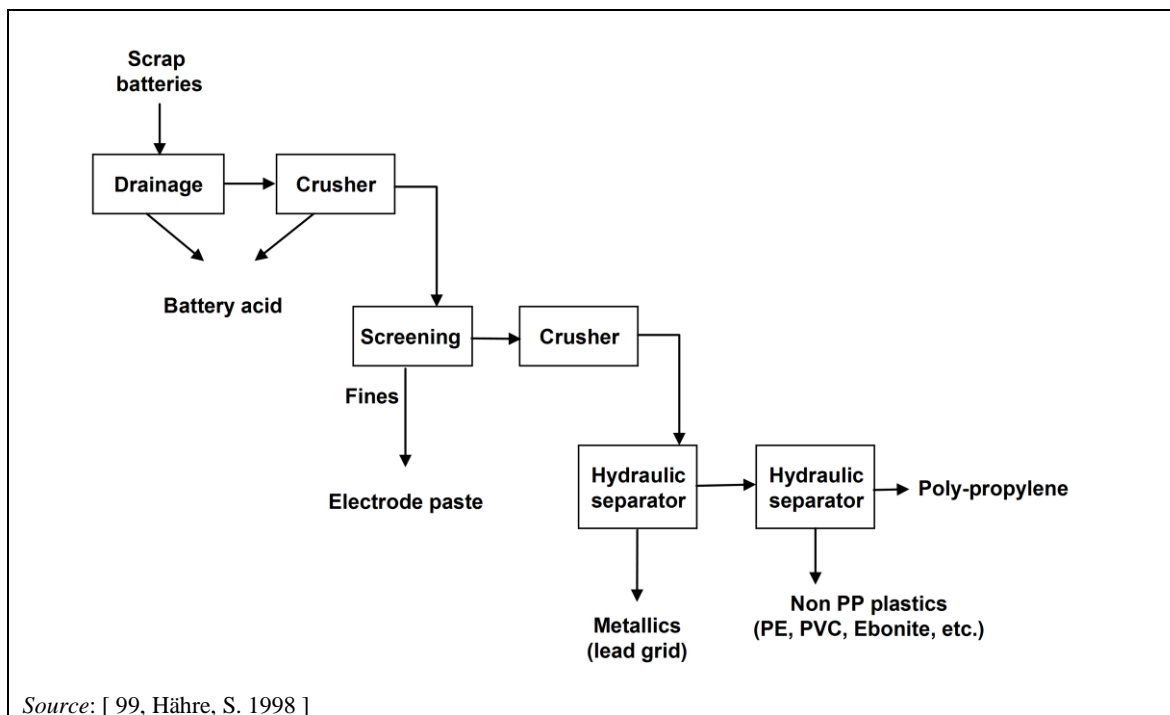

Figure 5.2: Outline of a typical lead-acid battery recovery process

Secondary lead smelting can be carried out in four main types of furnace:

- blast furnaces;
- rotary furnaces;
- reverberatory furnaces;
- electric furnaces.

In the blast furnace process (approximately 15 % of secondary lead production in the EU-28), the charge is filled at the top of the furnace. At the bottom of the furnace, oxygen-enriched air is blown inside to ignite the coke and smelt the materials in the charge. Air injected at the bottom reacts in the furnace, and the reacted gas flows to the top of the furnace through the material which has been charged from the top. Sulphur from the battery paste (lead sulphate) is mainly (> 90 %) captured in an iron matte. The remaining sulphur in the furnace (< 10 % of input) which has not been captured by the iron in the matte leaves the furnace as SO₂ gas. For the off-gas, unreacted hydrocarbons and residual CO are treated in a dedicated afterburner, followed by SO₂ scrubbing with dry lime or alkali water. These techniques are described in detail in Section 5.3.4.3. Where applicable, significant heat recovery can be achieved from the furnace flue-gas.

Rotary (the most common furnace currently employed), tilting rotary and reverberatory (the most common furnace in the US, and also used in the EU-28) furnaces can be either gas- or oil-fired, with oxygen enrichment also used in several installations. In rotary furnaces, smelting is usually carried out in batches, slag and metal are tapped out separately and batches of slag are treated to recover more lead and to produce a stable slag. The bulk of the sulphur in the charge is fixed in the slag. The slag can be a sodium-iron-sulphur compound with small amounts of lead and other metals or a silica slag, which is generally more acceptable for disposal. In tilting rotary furnaces, smelting is also carried out in batches but slag and metal can be successfully tapped together with no detrimental effects and separated after cooling. Sulphur fixing is also achieved very successfully in the slag and can be between 40 % and 80 % more efficient than with rotary furnaces (both using desulphurised paste), see Table 5.26. In reverberatory furnaces, smelting is continuous; sinter and metal are tapped separately. The sinter is smelted (usually in a rotary furnace) to produce a silica slag. The off-gas stream from the reverberatory furnace contains SO₂, which can react with lime to produce gypsum.

The following furnaces are described in Section 5.1.1.2 under primary smelting, but are briefly covered here as they can also be used to process secondary input materials.

In the Ausmelt/ISASMELT furnace, sulphur-containing paste and reducing agent are continuously fed into the furnace, and lead bullion is tapped periodically. When the process vessel contains the maximum volume of slag, a reducing agent and fluxes are added to produce a high-antimony bullion and a slag, [40, Ausmelt Ltd. 1996], [99, Hähre, S. 1998]. The slag may also be reduced in a separate furnace.

In the QSL furnace, some battery components such as battery paste are treated together with other secondary materials (e.g. dross, sludges, leaching residues, flue-dusts) [254, VDI 2004].

Crude bullion produced by either smelting method is refined by the methods described below in Section 5.1.4.

5.1.3.2 Recovery of lead from residues and scrap

Metallic lead scrap may be in a variety of forms. It may be contaminated by plastic material or bitumen and may be alloyed with other elements, notably tin, antimony and silver.

Clean scrap is melted in specially designed kettles, which are indirectly heated by oil or gas. Scrap is charged from a hopper situated above the kettle. Dross and tramp materials are skimmed from the surface of the molten metal and then pass through a screen that separates fine and coarse fractions. The dross is the fine fraction and is recycled as a non-metallic residue. The tramp material is mostly metal with a higher melting point than lead, and is treated elsewhere.

Residues, largely non-metallic in character, but often mixed with metallic lead scrap, are smelted with fluxes in rotary or blast furnaces.

The lead or lead alloy recovered from scrap or process residues is refined using the techniques described in Section 5.1.4.

5.1.3.3 Recovery of lead and tin from residues and from flue-dusts from copper smelting

The following techniques are applied to recover lead and tin in secondary copper smelters.

- Use of a second reduction stage. This is practised at one secondary copper smelter [90, Traulsen, H. 1998] where lead and tin are reduced with steel scrap or tin cans in a TBRC. Lead and tin scrap, slag and residues are added and a lead-tin alloy is produced. The alloy passes to a shaking ladle to remove residual copper, nickel and silicon and the decoppered alloy is then treated in a three-stage vacuum distillation system to separate lead and tin. The tin is refined by crystallisation before the second vacuum distillation stage.
- Use of flue-dust from the secondary copper converter (sometimes also from the blast furnace) as a feed material. Under reducing conditions, zinc is volatilised and recovered as oxide, while lead and tin are produced in the form of an alloy.
- Use of tin-lead alloy furnace technology in a multistage reduction process to produce black copper, tin-lead alloy and iron silicate slag from the KRS or TBRC slag [234, UBA (D) 2007]. As well as the molten converter slag, other intermediates from on-site production or from third parties and secondary materials are used as input materials. Materials or additives can be charged throughout the process. The slag composition is controlled within defined limits to obtain a marketable product. After a final granulation step, the slag can also be sold. The black copper is recirculated into the KRS or TBRC furnace. The process and secondary hood off-gases are routed to filter systems. The collected flue-dust is either marketed or returned to the KRS bath furnace. Refining of the tin-lead alloy includes the following steps:
 - o segregation and dedrossing (removal of copper and nickel);
 - o removal of the rest of the copper, zinc and arsenic by adding sulphur, ammonium chloride and aluminium.
- Use of a rotary rocking furnace to recover lead from the flue-dust from primary copper smelting. The streams of flue-dust from copper smelting furnaces, captured in dry and wet dedusting systems, with sodium carbonate (flux) and (if necessary) coke, are mixed in the required proportion and hermetically enclosed and transported into a container situated above the furnace. Iron scrap is essential for the process, and this is stored in a separate storage container. The furnace is loaded using a special loading device, and the melting process then takes place. Crude lead is poured into moulds, to be further refined. The flue-gas, after dedusting in a bag filter, is transferred to a (semi-dry) desulphurisation plant, where lime milk (a suspension of fine calcium hydroxide particles in water) is sprayed. The desulphurisation product is collected in a final bag filter and disposed of or returned to the copper smelting furnaces as flux. Lead slag obtained from lead smelting of the copper smelter's flue-dust is returned on site to copper production, where it is added to shaft furnaces together with briquetted copper concentrate.
- Use of electric furnaces for complex secondary materials such as those containing copper/lead, i.e. dusts, drosses, slags, slimes, copper alloy scrap, low-grade matte, copper/lead concentrates and other copper/lead-bearing materials. The furnace is operated on a campaign basis. Depending on the feed material, lead bullion, copper/lead matte or copper/lead species are separated from the slag. Reducing agents include iron, coal and coke. Fine and sludge-type feed materials are pelletised to prevent diffuse emissions, and then dried to less than 2–3 wt-% of water with hot air in a conveyor-type dryer or a vacuum dryer. Raw materials are fed onto the top of the bath where they react to produce

metal and slag, which are tapped periodically. Flue-dust is collected and zinc is recovered from it. Crude lead bullion is further refined by pyrometallurgical lead refining.

5.1.3.4 Recovery of tin from steel scrap

Steel scrap can be detinned by either electrolytic or chemical leaching processes using caustic soda and sodium nitrite [8, Hatch Associates Ltd 1993]. In the latter case, ammonia is released (0.048 kg per kg of tin). Tin is dissolved and then recovered by electrolysis, during which the tin is removed from the cathodes by dipping in a molten bath of tin. Ingots or tin powder are produced, and these can be used to produce a range of alloys and coating materials.

Tin is melted in kettles similar to those used for lead, and alloys are produced. Scrap tin is also recovered in the melting processes. The most common alloys are solders and they use lead as the alloying material. Other melting furnaces are used but temperature control is not as easy.

5.1.3.5 Recovery of lead, tin and other metals from secondary raw materials and wastes

Lead and other metals can be recovered from secondary raw materials and wastes, such as leaching residues from zinc smelters, drosses from lead refineries, mattes, slags, sludges and flue-dust. Additional feed can consist of complex primary raw materials (e.g. copper/lead concentrates) and end-of-life materials (e.g. electronic scrap). This leads to a complex flowsheet where not only lead, but also other metals such as copper, nickel, tin, antimony, precious metals, selenium, tellurium and indium can be recovered.

A calculated mix of these materials is fed into an oxidising smelter, such as an ISASMELT one, where copper containing precious metals is separated from the other metals, which are oxidised in the form of a slag.

This slag is then reduced (e.g. in a blast furnace), and an impure lead bullion is produced together with depleted slags. The lead bullion is sent for further refining in a lead refinery, where tin, antimony, arsenic, bismuth and precious metals are concentrated in separate fractions.

Process gases from the oxidising smelter contain higher amounts of SO₂. They are sent to a sulphuric acid plant after thorough dedusting and drying.

5.1.4 Refining of primary and secondary lead and tin

In primary and secondary lead and tin production, the raw metals produced are refined, alloyed and cast to market qualities. Alloying and casting are described in Section 5.1.5. In addition, metals from other sources (lead and lead scrap, tin and tin scrap, alloying metals) are used.

Lead bullion may contain varying amounts of copper, silver, bismuth, antimony, arsenic and tin. Lead recovered from secondary sources may contain similar impurities, but generally antimony dominates. There are two methods of refining crude lead: electrolytic refining and pyrometallurgical refining. Electrolytic refining uses anodes of decoppered lead bullion and starter cathodes of pure lead. This is an expensive process and is not currently used by plants in the EU-28, although it is used in a number of other countries worldwide.

Pyrometallurgical refining consists of a series of kettles, which are indirectly heated by oil or gas [4, Hatch Associates Ltd 1993], [99, Hähre, S. 1998], [304, KGHM 2009]. Remelting is needed as a first step if the metals are not received in a liquid state. Refining kettles are not considered suitable for melting scrap lead contaminated with organic materials. Copper is the first element to be removed and separates as sulphide dross. If the crude metal is deficient in

sulphur, more must be added in the form of sulphur powder or galena/pyrite. The sulphide dross is removed from the metal surface by mechanical skimmers that discharge into containers.

Tellurium, arsenic, antimony and tin are removed by oxidation (in the Harris process). The usual method, often referred to as 'lead softening', involves a reaction with a mixture of sodium nitrate and caustic soda, followed by mechanical skimming to remove the oxide dross. Air or oxygen can also be used as the oxidising agent. Depending on the crude lead composition, i.e. the amount of impurities, the molten salt mixture may be granulated in water and the impurities separated hydrometallurgically [254, VDI 2004].

Tin and lead can also be separated from each other by vacuum distillation at high temperatures. As a result of this, both pure lead and tin can be recovered.

Desilvering is carried out by the Parkes process, which makes use of the preferential solubility of silver in zinc. Zinc is added to the lead at about 470 °C and the mix is then allowed to cool to 325 °C. A silver-lead-zinc alloy separates and forms a crust on the surface. The crust is removed and zinc is separated from the silver by vacuum distillation. The silver bullion is further refined using oxygen to produce crude silver. Excess zinc is removed from the desilvered lead by vacuum distillation and then by treatment with caustic soda.

Bismuth is removed by treatment with a mixture of calcium and magnesium (the Kroll-Bettertone process). A calcium-magnesium-bismuth alloy is formed as dross on the surface of the lead and is removed by skimming. The dross is then oxidised using lead chloride, chlorine gas, or a mixture of caustic soda and sodium nitrate, and the calcium and magnesium oxide is removed by skimming. A bismuth-lead alloy is recovered and undergoes further refining to produce bismuth. An example diagram of lead refining processes is given in Figure 5.3.

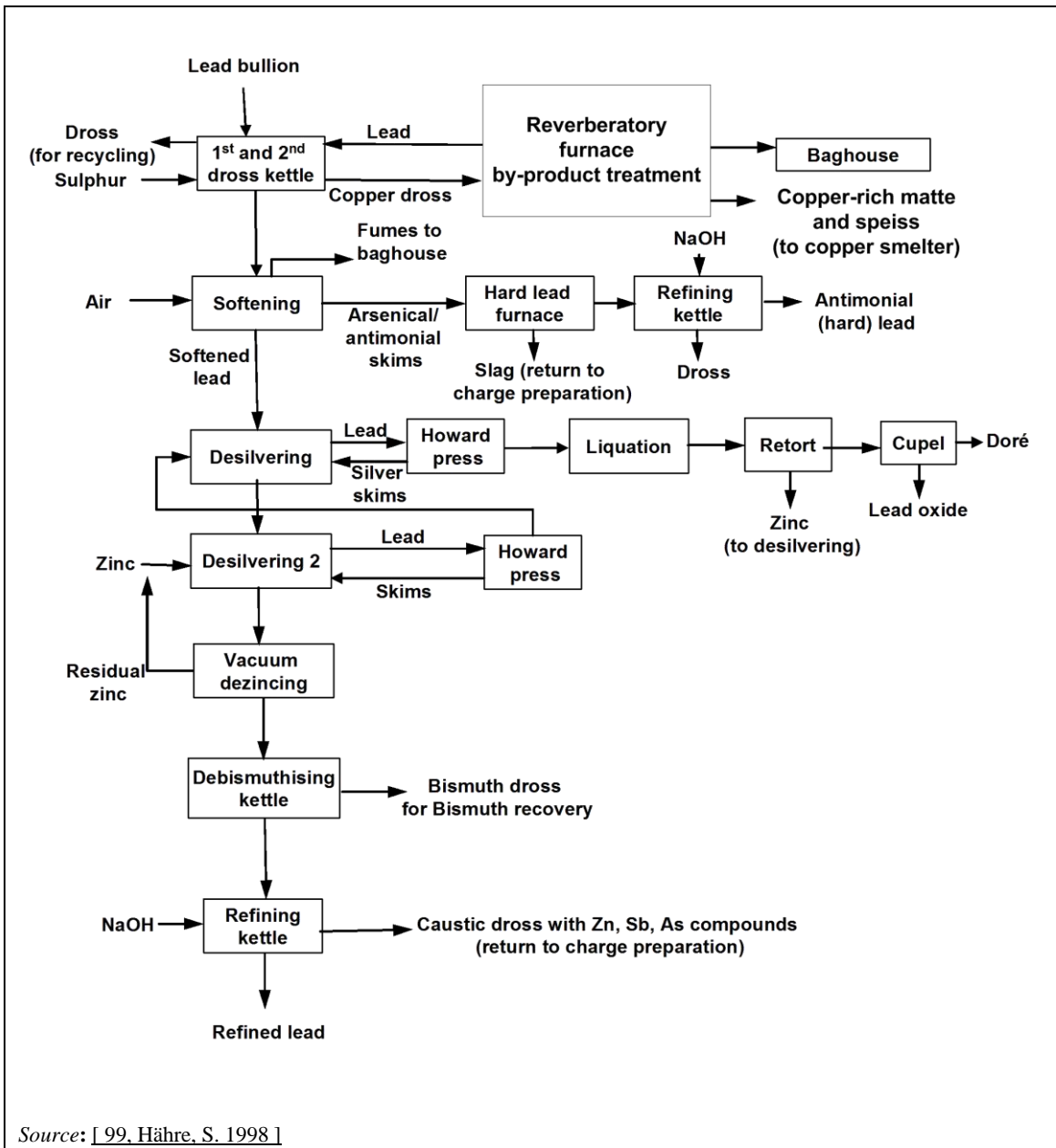

Source: [99, Hähre, S. 1998]

Figure 5.3: Example diagram of lead refining processes

If thallium is present it can be removed using zinc chloride and silica, forming a thallium-rich dross which is skimmed off [304, KGHM 2009].

The pure lead is cast into blocks or ingots as pure lead or lead alloy. Fume, dross, litharge and other residues are usually smelted in a small blast furnace or a rotary furnace to produce lead bullion, which is recycled to the refining circuit.

Tin and tin-lead alloys are refined by both hydrometallurgical and pyrometallurgical routes. The hydrometallurgical method uses electrorefining. This, however, is only applied on a very small scale in the EU (< 1000 t/yr). Pyrometallurgical refining is very similar to lead refining. Iron is removed by liquation, copper is removed by the addition of sulphur, and arsenic or antimony is removed by the addition of aluminium or sodium.

5.1.5 Melting and alloying processes for lead

Melting and alloying are usually carried out in indirectly heated crucible furnaces or kettles, using electricity, oil or gas. Refined lead is melted in a kettle and alloying elements are added. Temperature control of the melt may be important [254, VDI 2004]. Lead and lead alloys are usually cast into permanent cast-iron moulds [4, Hatch Associates Ltd 1993].

Static moulds and conveyor casting machines are used to produce blocks, slabs and ingots. Continuous casting machines are used to produce rods for reduction to wire. Fume extraction is used at the launders and tapping points.

5.2 Current emission and consumption levels

The main environmental issues of the lead and tin industry are air and water pollution and the generation of hazardous wastes. Plants generally have their own waste water treatment facilities, and waste water recycling or reuse is usually practised.

Many wastes are reused, but the main issue is leach residue, which has a high environmental impact [98, Lijftogt, J.A. et al 1998]. Some local aspects, like noise, are also relevant to the industry. Due to the hazardous nature of some solid and liquid waste streams, there is also a significant risk of soil contamination [237, UBA (A) 2004].

Table 5.5 to Table 5.8 give input and output balances for some lead plants in Europe.

Table 5.5: Input and output data for an Ausmelt/ISASMELT furnace

Inputs	(t/yr)	Outputs	(t/yr)
Battery lead paste	100 000	Lead bullion	125 000
Lead concentrates	60 000	Sulphuric acid	50 000
Battery grids	35 000	Lead concentrate	43 500
Other secondary	5000	Silver	30–70
Coal or coke	5000	Furnace lining	300–400
Oxygen	15 000 000 Nm ³ /yr	CO ₂	50 000
Natural gas	140 000 MWh/yr	Waste water (process)	2 m ³ /h
Electrical energy	45 000 MWh/yr	Off-gas	32 000–49 000 m ³ /h
<i>Source: [234, UBA (D) 2007]</i>			

Table 5.6: Input and output data for a QSL plant

Inputs	(t/yr)	Outputs	(t/yr)
Lead concentrates	145 000	Lead bullion	135 000
Secondary materials	100 000	Sulphuric acid	100 000
Fluxes	8000	Slag	75 000
Coal	15 000	Copper/lead matte	4500
Oil	100	Silver	260–300
Oxygen	50 000 000 Nm ³ /yr	Zn/Cd carbonate	250
Natural gas	3 300 000 Nm ³ /yr	CO ₂	61 500
Electrical energy	9 000 000 MWh/yr	Off-gas	20 400 m ³ /h
		Waste water (cooling)	2 m ³ /h
<i>Source: [234, UBA (D) 2007]</i>			

Table 5.7: Input and output data for a battery recovery plant with desulphurisation (preparation and short rotary furnace)

Inputs	(t/yr)	Outputs	(t/yr)
Melting materials			
Battery scrap	42 000	Crude lead	43 000
Lead scrap	5400	Polypropylene chips	1800
Secondary materials	2600	Slag	10 000
Internal returns	10 700	Sodium sulphate	4700
Fluxes			
		Furnace lining	35
NaOH	7000	CO ₂	10 800
Steel borings	2300	Off-gas	22 000 m ³ /h
Soda	2200	Waste water (process)	105 000 m ³ /yr
Leaded glass	1700	Slag	10 000
Energy			
Coke	2400		
Oxygen	3 700 000 Nm ³ /yr		
Natural gas	1 400 000 Nm ³ /yr		
Electrical energy	3 800 000 kWh/yr		
<i>Source: [234, UBA (D) 2007]</i>			

Table 5.8: Input and output data for a battery recovery plant with whole battery smelting (shaft furnace)

Inputs	(t/yr)	Outputs	(t/yr)
Used batteries, dry	50 000–60 000	Lead bullion	49 000–50 000
Other lead scrap, waste	13 250–16 500	Flue-dust	2500–2800
Other inputs (iron)	5500–7000	Excess slag	1500–3000
Slag (return)	12 500–14 000	Return slag	12 500–14 000
Sludge from water treatment	3850–4450	Off-gas	65 000 Nm ³ /h
Flue-dust	500–650	Iron/lead matte	9800–10 200
Coke	4950–5950	Spent acid	4000–8000
Coal	0	CO ₂	
Oxygen	1 000 000 Nm ³ /yr	Off-gas	65 000 m ³ /h
Natural gas	477 500 Nm ³ /yr	Waste water (process)	0 m ³ /yr
Electrical energy	10 390 000 Wh/yr	Furnace lining	110
<i>Source: [234, UBA (D) 2007], [340, ILA 2013]</i>			

5.2.1 Energy

The energy requirements for different lead and tin production processes vary widely, depending on the quality of the feed and the products, the use of latent or waste heat, and the production of by-products. Table 5.9 shows the average energy requirements of the different processes, excluding the energy content in the raw material.

Table 5.9: Energy requirement of various lead processes

Process	Electric (kWh/t Pb)	Coke (kg/t Pb)	Coke (kWh/t Pb) ⁽¹⁾	Gas (Nm ³ /t Pb)	Gas (kWh/t Pb) ⁽²⁾	O ₂ (Nm ³ /t Pb)
QSL ⁽³⁾	70	Coal: 110	900	25	275	370
Ausmelt/ISASM ELT with refinery and other operations ⁽³⁾	360	40	350	102	1120	120
Pb shaft furnace secondary ⁽⁴⁾	100–150	110–130	930–1150	20–30	200–300	20
Rotary furnace with mechanical battery breaking system and sodium or calcium sulphate production ⁽⁴⁾	180–250	60–100	520–900	90–180	1000–2000	150–200
Reverberatory furnace ⁽⁴⁾	80–140	20–30	175–270	55–70	600–800	110–150
⁽¹⁾ Conversion of kt/t into kWh/t by multiplying by a factor of 8.85. ⁽²⁾ Conversion of Nm ³ /t into kWh/t by multiplying by a factor of 11. ⁽³⁾ Primary furnaces. ⁽⁴⁾ Secondary furnaces. Source: [234, UBA (D) 2007], [397, ILA 2012]						

5.2.2 Emissions to air

The emissions to air are either captured as stack emissions or can escape the process as diffuse emissions, depending on the age of the plant and the technology used. Stack emissions are normally monitored continuously or periodically and reported. Diffuse emissions are a cause for concern and should be captured.

The main emissions to air from lead and tin production are:

- sulphur dioxide (SO₂), other sulphur compounds and acid mists;
- oxides of nitrogen (NO_x) and other nitrogen compounds;
- metals and their compounds;
- dust;
- VOCs and PCDD/F.

Other pollutants are considered to be of negligible importance for the industry, because they are not present in the production process or because they are immediately neutralised (e.g. chlorine or HCl) or because they occur in very low concentrations (e.g. CO). Emissions are to a large extent bound to dust (except cadmium, arsenic and mercury which can also be present in the vapour phase) [98, Lijftogt, J.A. et al 1998].

The sources of emissions depend on the process used and are shown in

Table 5.10.

These include:

- roasting (most emissions occur during unscheduled shutdowns);
- other pretreatments (e.g. battery breaking);
- transport and handling of material;
- the sulphuric acid plant;
- smelting (including slag granulation) and refining;
- casting.

Table 5.10: Significance of potential emissions to air from lead production

Component	Roasting, Sintering, smelting	Refining	Battery breaking	Casting, etc.	Sulphuric acid plant
Sulphur oxides	•• ⁽¹⁾	•	•	•	•••
Nitrogen oxides	• ⁽¹⁾	NR	NR	•	•
Dust and metals	••• ⁽¹⁾	•	•••	•••	NR
VOCs and PCDD/F	•(••) ⁽²⁾	NR	NR	• ⁽¹⁾	NR

⁽¹⁾ The direct emissions from the roasting or smelting stages are treated and/or converted in the gas-cleaning steps and sulphuric acid plant; the remaining emissions of sulphur dioxide and nitrogen oxides from the sulphuric acid plant are still relevant. Diffuse or uncaptured emissions are also relevant from these sources. Secondary smelting of battery paste is a source of SO₂.
⁽²⁾ PCDD/F and VOCs may be present if secondary materials are used that contain PCDD/F or are contaminated with organic materials.
 NB: ••• More significant – • Less significant.
 NR = Not relevant.

Besides process emissions, diffuse emissions occur. The major diffuse emission sources are:

- dust from the storage and handling of concentrates;
- leakage from roasters and smelters;
- dust from the exhaust gases of casting furnaces;
- miscellaneous.

Although diffuse emissions are difficult to measure and estimate, there are some methods that have been used successfully to do so (see Section 2.3.5). Table 5.11 gives some emission data for a primary lead process using an Ausmelt/ISASMELT furnace [99, Hähre, S. 1998], and illustrates the potentially high level of diffuse emissions.

Table 5.11: Significance of the diffuse emissions

Ausmelt/ISASMELT plant (2009) (kg/yr)			
Emissions	Controlled	Diffuse	Total
Lead	596	312	908
Cadmium	3.07	0.24*	3.31
Antimony	5.05	1.77*	6.82
Arsenic	0.93	1.55*	2.48
Thallium	1.83	< 0.01*	1.83
Mercury	0.87	< 0.01*	0.87
Sulphur dioxide (t/yr)	343	NR	343
* Estimated values. NB: Lead production in 2009: 114 161 t. NR: Not relevant. Source: [397, ILA 2012]			

5.2.2.1 Sulphur dioxide and other sulphur compounds

The major sources of sulphur dioxide emissions are diffuse emissions from the oxidation stages, direct emissions from the sulphuric acid plant and the emissions of residual sulphur in the furnace charge. Good extraction and sealing of the furnaces prevents diffuse emissions, with the collected gases from the oxidation stages passed to a gas-cleaning plant and then to the sulphuric acid plant or gypsum plant.

After cleaning, the sulphur dioxide in the gas from the sintering, roasting or direct smelting stages is converted to sulphur trioxide (SO₃) (see Section 2.7.1). During start-up and shutdown, there may be occasions when weak gases are emitted without conversion. These events need to be identified for individual installations. However, many companies have made significant improvements to process controls to prevent or reduce these emissions [98, Lijftogt, J.A. et al 1998], [99, Hähre, S. 1998].

Lead sinter and some secondary raw materials contain residual sulphur and sulphates. It has been reported [126, Madelin, B. et al. 1991] that 10 % of the sulphur content of lead concentrate remains in the sintered material that is fed into the furnaces. Similarly, the sulphate content of battery scrap may be significant depending on the way it is pretreated [266, Italy 2008] and whether the paste is included. In most cases, the sulphur is fixed in the slag or in other by-products. The extent of fixation depends on the fluxes used and the other metals associated with the process, for example copper matte may be produced when copper and lead concentrates are treated together. Pb-Fe matte is produced under reducing conditions when iron turnings are added. In other cases, SO₂ may be emitted and may need further treatment.

Emissions from several lead processes are shown in Table 5.12 below.

Table 5.12: Sulphur dioxide production from several lead processes

Process	Total lead production (t/yr)	Sulphur dioxide produced (g/t of lead)
QSL ⁽¹⁾	135 000	700
ISASMELT ⁽¹⁾	120 000	3000
Battery - whole ⁽²⁾	50 000	4000–6000
Battery - desulphurised paste ⁽²⁾	35 000–50 000	1070–3000
Battery - paste excluded ⁽²⁾	35 000	3200
Batteries + extra paste ⁽²⁾	10 000	210 (FGD system)
Lead shaft furnace and sinter plant ⁽¹⁾	110 000	10 000–45 000
Batteries - MA process ⁽²⁾	33 000	6600
⁽¹⁾ Primary furnaces. ⁽²⁾ Secondary furnaces. Source: [234, UBA (D) 2007], [377, ILA 2013]		

Mists from battery breakers can also cause similar emissions. Emissions from smelters using battery-derived material contain SO₂, the concentration depending on whether the paste is smelted or is desulphurised first or is fixed with the slag. Typical figures are 50 mg/Nm³ to 500 mg/Nm³ [99, Hähre, S. 1998].

5.2.2.2 Nitrogen oxides

The smelting stages are potential sources of nitrogen oxides (NO_x). NO_x may be formed from nitrogen components that are present in the concentrates or as thermal NO_x. The sulphuric acid produced can absorb a large part of the NO_x, and this can affect the sulphuric acid quality. Other furnaces that use oxy-fuel burners can also exhibit a reduction in NO_x. The range for all the processes is 20 mg/Nm³ to 300 mg/Nm³.

5.2.2.3 Dust and metals

Dust carry-over from the smelting processes is a potential source of direct and diffuse emissions of dust and metals. The gases are collected and treated in the gas-cleaning processes and for SO₂-rich gases in the sulphuric acid plant. Dust is removed, leached to bring out Cd or Cl₂ if necessary, and returned to the process.

Slag treatment and quenching also give rise to dust. The range of dust emissions from these channelled sources is < 1 mg/Nm³ to 20 mg/Nm³. The slags and dross produced during the recovery of lead from batteries can contain antimony. When these residues become wet, there are potential emissions of stibane, which is a poisonous gas. However, this is not the case for all slags (i.e. if they do not contain hydrogen-generating materials).

Emissions of aerosols take place in the cell room and battery breakers and may contain metals. The range of mist and dust emissions from these sources is 0.1 mg/Nm³ to 4 mg/Nm³.

While controlled emissions have known sources and can be captured and treated, diffuse emissions can evolve almost anywhere on a plant site. The main sources of diffuse emissions

are material storage and handling, dust sticking to vehicles or streets, and open working areas or areas where no abatement has been performed. The mass releases of metals from some European processes are given in Table 5.13

In recent years, some companies have reduced their diffuse emissions efficiently by applying measures such as [234, UBA (D) 2007], increasing the burden of the shaft furnace and improving the off-gas collection;

- renewing the off-gas collection and filter units;
- reducing the furnace downtime by improving the refractory lining (thereby reducing start-up and shutdown times, which can cause higher emissions for a limited time);
- closing the roofs of the process buildings and modernising the filters;
- closing/housing the delivery, material storage and refining areas and installing off-gas collection systems;
- improving material handling procedures (e.g. by wetting bulk materials before and during loading), and reducing transport frequencies (e.g. by using bigger wheel loaders);
- installing obligatory vehicle washing (for plants and external vehicles);
- applying reinforcements to plant areas and driveways and optimising cleaning procedures;
- closing and decontaminating old slag disposal areas.

Table 5.13: Mass release of metals from some European processes

Process	Product	Production (tonnes)	Dust (g/t _{product})	Zn (g/t _{product})	Pb (g/t _{product})	Cd (g/t _{metals})	As (g/t _{metals})
QSL	Lead						
- process	Pb bullion	120 000	1	NA	< 0.1	< 0.01	< 0.0001
- refinery	Pure Pb, Pb alloys	135 000	5.4	NA	< 0.1	< 0.01	< 0.01
- secondary ⁽¹⁾			12	NA	2.3	0.03	0.09
Ausmelt/ISASMELT	Lead						
- process	Pb bullion	113 000	< 1	0.09	2.5	< 0.1	0.01
- refinery	Pure Pb and Pb alloys	120 000	NA	1	4	0.01	0.02
- secondary ⁽¹⁾			NA	0.04	0.3	< 0.01	< 0.01
Battery - whole (shaft)	Lead						
- process		49 000	10–25	0.1	2.5	< 0.1	< 0.15
- refinery		53 000	0.49	NA	0.024	NA	NA
- secondary ⁽¹⁾			< 2 mg/Nm ³	NA	< 0.01 mg/Nm ³	NA	NA
Battery - desulphurised paste	Lead						
- process		43 000	1–3	NA	0.1–1	0.01	0.18
- refinery		52 000	4	NA	0.5	0.02	0.24
- secondary ⁽¹⁾			6	NA	0.3	NA	0.02
Battery - whole (short rotary)	Lead						
- process		10 000	15–35	NA	< 0.5	NA	< 0.3

NB: NA = not available.
⁽¹⁾ Secondary hood dedusting.
Source: [234, UBA (D) 2007]

5.2.2.4 Organic compounds (VOCs, PCDD/F) and CO

Organic carbon compounds and CO can be emitted from the drying stage depending on the raw materials and the fuel used for drying. But, in lead production, the most significant source of organic carbon compounds and CO is the reduction step of the smelting process, especially when plastic/plastic residues are present in the furnace charge. An afterburner is the most common technique used to abate these pollutants [ILA 2012].

In the production of lead, the emissions of total volatile organic carbon (TVOC), expressed as C, depend on the type of furnace and processes employed. Where afterburners are used the TVOC emissions are, on average, below 10 mg/Nm³ and the maximum values are usually below 40 mg/Nm³.

The emissions of CO from the shaft furnace are in the range of 500 mg/Nm³ [ILA 2012].

The formation of PCDD/F in the combustion zone and in the cooling part of the off-gas treatment system (de novo synthesis) may be possible in some processes, particularly if plastic components are included in the secondary materials that are fed into the process [237, UBA (A) 2004].

In the production of lead, the emissions of PCDD/F are, on average, below 0.1 ng I-TEQ/Nm³, and the maximum values are usually below 0.4 ng I-TEQ/Nm³. The values are independent of the feed material due to the use of abatement techniques [234, UBA (D) 2007].

5.2.3 Emissions to water

Metals and their compounds and materials in suspension are the main pollutants emitted to water. The metals concerned are Zn, Cd, Pb, Hg, Se, Cu, Ni, As, Co and Cr [25, OSPARCOM 1996], [98, Lijftogt, J.A. et al 1998], [99, Hähre, S. 1998], [27, M. Barry et al. 1993], [234, UBA (D) 2007]

Other significant substances that are emitted to water are chlorides, fluorides and sulphates.

The possible waste water streams that contain the aforementioned substances are:

- waste water from wet scrubbers;
- waste water from wet electrostatic precipitators;
- waste water from the mercury removal step;
- waste water from battery breaking and classification stages;
- waste water from slag granulation;
- sealing water from pumps;
- water from general operations, including cleaning of equipment, floors, etc.;
- discharge from cooling water circuits;
- rainwater run-off from surfaces (in particular storage areas) and roofs.

Waste water from the smelter stage gas cleaning can be the most significant waste water source.

5.2.3.1 Waste waters from abatement plants

Generally, wet gas cleaning systems operate with liquid recycling. A monitored bleed keeps suspended solids and dissolved salts within certain defined limits. The bleed is either treated separately or in an integrated water treatment plant to remove solids and dissolved species before discharge. The destination of the separated material depends on the origin of the waste water.

Wet electrostatic precipitators will also produce an acidic scrubbing liquid. This is recycled after filtering. Some liquid should be bled from this circuit to remove build-up of contaminants. This bleed liquid is treated and analysed before discharge [98, Lijftogt, J.A. et al 1998].

The mercury removal step takes place prior to the sulphuric acid plant and involves a gas-liquid contact tank or spray tower in which the liquid contains a reagent that combines with mercury and removes it. Mercury chloride (HgCl_2) is frequently used as the reagent and reacts with metallic mercury from the gas to form a solid precipitate of Hg_2Cl_2 (calomel). The relatively clean liquid is discharged as waste water for further treatment. The solid Hg_2Cl_2 is sold for mercury recovery or treated to produce mercury chloride again or stabilised for final disposal.

Table 5.14 provides an indication of the composition of the gas-cleaning liquids before treatment.

Table 5.14: Typical gas-cleaning effluents before treatment

Component	Concentration (dissolved)	Composition of suspended solids
Solids		250–1500 mg/l
Sulphate	13–25 g/l	
Chloride	1.3–1.8 g/l	
Fluoride	0.3–0.5 g/l	
Mercury	0.1–9 mg/l	5–30 % of suspended solids
Selenium	0.1–50 mg/l	10–60 % of suspended solids
Arsenic	5–95 mg/l	< 0.05 % of suspended solids
Zinc	0.1–2.5g/l	2–6 % of suspended solids
Cadmium	1–95 mg/l	
Lead	1–13 mg/l	5–50 % of suspended solids
<i>Source: [99, Hähre, S. 1998]</i>		

5.2.3.2 Waste waters from battery recovery

The battery breaking and washing stages produce an effluent which is acidic and contains lead and other metals in suspension and solution. This effluent is neutralised and the water is recycled in the process. If possible, the acid is used elsewhere. A portion is usually bled from the system to control dissolved salts. Cooling water can also arise from cooling the crushing process [237, UBA (A) 2004].

These processes produce contaminated surface water as well and consequently this water is also treated and reused. It is common practice to discharge a bleed of this sealed water circuit after further treatment and analysis. Road and surface contamination is minimised by the frequent wet cleaning of roads, hardstanding areas and lorries, and by cleaning up spillages.

The quality and quantity of waste water depend on the process used, the composition of the raw materials used in the process and the practices used by the operators. The reuse of process water and rainwater is common.

Cooling water from the granulation of slag or the cooling pond is usually recirculated in a closed circuit system.

Typical waste water analyses of some processes are given in Table 5.15.

Table 5.15: Typical waste water analyses

Process	Effluent	Flow	Main components (mg/l)					COD
	(m ³ /yr)	(m ³ /h)	Pb	Cd	As	Zn	Ni	
QSL ⁽¹⁾	158 000	18	0.06	0.02	0.04	0.15	0.01	20
Ausmelt/ ISASMELT ⁽¹⁾ ⁽²⁾	110 000	13	0.01–0.09	0.001–0.01	0.001–0.1	0.01–0.2		50–200
Mechanical battery separation (CX) + rotary furnace ⁽³⁾	190 000	< 0.2 ⁽¹⁾						
Mechanical battery separation (MA) + rotary furnace ⁽³⁾	124 000		0.02	0.07	< 0.0005	0.27	0.09	
Whole battery ⁽³⁾	150 000	40	0.4	0.01	< 0.001	0.01	< 0.05	96
Shaft furnace ⁽³⁾	17 000		< 0.2	< 0.1		< 0.3		
CX + rotary furnace + Pb refinery ⁽³⁾	105 000	2.1	0.13	0.01	0.01		0.03	
⁽¹⁾ Primary furnaces. ⁽²⁾ The Ausmelt plant has no waste water treatment plant. The treated effluent is from a Zn smelter, Pb smelter and surface water. ⁽³⁾ Secondary furnaces. ⁽⁴⁾ The CX process produces condensate from the crystalliser which has a very low metal content and a conductivity of < 10 microsiemens. Source: [234, UBA (D) 2007]								

A summary of potential waste water sources and treatment techniques is given in Table 5.16.

Table 5.16: Potential waste water sources and treatment techniques

Process unit	Operation/source	Use/treatment options
General	Rainwater from roads, yards, roofs, wet cleaning of roads, cleaning of lorries, etc.	Waste water treatment plant then reuse or recirculation
Battery separation	Process liquor	Used in the desulphurisation process/waste water treatment plant
Paste desulphurisation	Process liquor	Used in the desulphurisation process/waste water treatment plant
Smelting and melting operation	Cooling water from furnace, machinery and equipment	Recirculation
Slag granulation	Wet ESP effluent. Granulation water	Recirculation, waste water treatment plant. Recirculation
Gas-cleaning system	Condensate from gas cooling and wet ESP. Condensate from mercury removal	Removal of suspended dusts and reuse as raw material, waste water treatment plant. After mercury removal, to waste water treatment plant. Recirculation
Sulphuric acid plant	Cooling water equipment. Leakage	Recirculation. Waste water treatment plant
Feed storage	Surface water (rain/wetting)	Waste water treatment plant
Sinter plant	Scrubber (sinter fine cooling)	Waste water treatment plant
All process units	Maintenance	Waste water treatment plant
Waste water treatment plant	Effluent treatment	Reuse for certain applications/discharge

5.2.4 Process residues

The production of metals results in the generation of several by-products, residues and wastes, which are listed in the European List of Wastes (Commission Decision of 3 May 2000 replacing Decision 94/3/EEC).

Solid residues derived from various processes and abatement stages may have one of three possible destinations:

1. recycling in, or upstream of, the process;
2. downstream treatment to recover other metals;
3. final disposal after treatment to ensure safe disposal.

The refining stage of lead generates other metal-rich solids. These are usually rich in a specific metal and are thus recycled to the appropriate production process. Also, slag from the production of tin from cassiterite is the main source of tantalum and niobium.

Solid residues also arise as a result of the treatment of liquid effluents. The main waste stream is gypsum waste (CaSO_4) and metal hydroxides that are produced at the waste water neutralisation plant. These wastes are considered to be a cross-media effect of these treatment techniques, but many are recycled to the pyrometallurgical process to recover the metals.

Dust or sludge from the treatment of gases are used as raw materials for the production of other metals, such as Ge, Ga, In and As, or can be returned to the smelter or into the leach circuit for the recovery of lead and tin.

Mercury and selenium residues arise from the pretreatment of mercury or selenium streams from the gas-cleaning stage. This solid waste stream amounts to approximately 40–120 t/yr in a typical plant. Because of the restrictions on mercury use, mercury recovery from Hg-Se residues, or from calomel from the mercury removal stage, is no longer an option. Both by-

products need to be stabilised for final disposal. In exceptional cases when the Se to Hg ratio is high, recovery of selenium may be an option.

5.2.4.1 Pyrometallurgical slags and residues

Slags from the blast furnace and direct smelting usually contain very low concentrations of leachable metals. They are therefore generally suitable for use in construction [99, Hähre, S. 1998]. The slag output is between 10 wt-% and 70 wt-% of the metal produced, depending on the raw materials used.

Slags from the battery processing plants account for 13–25 % of the weight of lead produced. They may be suitable for construction uses depending on the leachability of the metals they contain. The leachability is influenced by the fluxes used and the operating conditions [99, Hähre, S. 1998]. The use of sodium-based fluxes (Na_2CO_3) to fix sulphur in the slag causes an increase in the quantity of leachable metals. These slags and dross from battery recovery processes can contain antimony. This is normally recovered, but storage in damp conditions can, under certain conditions, cause the emission of stibane.

A number of standard leachability tests are used by Member States and these are specific to the country in question. Processes are under investigation to lower the contents of entrained metals, in order to ensure the future suitability for construction and other applications.

The dross and solids removed during lead and tin melting and refining stages contain metals that are suitable for recovery.

Table 5.17 details some of the solid material output from the refining of lead bullion.

Table 5.17: Solid material from the refining of lead bullion

Refining step	Solid output	Use/treatment options
Drossing/decoppering	Copper dross	Further processing to recover copper and lead
Softening (Harris process/ oxygen softening)	Harris slags Antimony slag	Hydrometallurgical treatment for metal recovery Pyrometallurgical treatment for metal recovery
Desilvering	Zinc-silver crust	Recovery of noble metals
Dezincing	Zinc metal	Reuse for desilvering
Debismuthising	Bismuth crust	Recovery of bismuth
Removal of alkali metals and alkaline earth metals	Mg-Ca oxide dross	Internal recycling as flux
Finishing	Caustic dross	Internal recycling

Source: [13, HMIP (UK) 1994]

Table 5.18 and Table 5.19 show the use or treatment options for the residues produced by several processes.

Table 5.18: Residues from lead processes

Production step	Product or process residue	Quantity (kg/t Pb)	Use or treatment option
Slag fuming plant			
Slag fuming	Slag	700	Water-resistant construction material
	Matte Steam	2.5–25 2500	To Cu smelter Energy conversion
Battery process - short rotary ⁽¹⁾			
Physical treatment of batteries	Na ₂ SO ₄ (CX)	220	Sale
	Battery paste (MA)	700	To primary and secondary smelter
	Polypropylene	100–130	Sale
	Residual plastics	70–80	Disposal or incineration
Smelting	Lead bullion	830	To refinery
	Slag	80–120	Disposal
	Flue-dust	30–50	After treatment back to Pb smelter
Refining	Dross	60–90	To primary smelter
Waste water	Precipitated sludge		Return to smelter
All stages	Slag, flue-dust, etc.	500–550	Internal recirculation
Battery process - blast furnace			
Feed preparation	Spent acid	70–120	External use or neutralisation
Shaft furnace	Fe-Pb matte	80–250	Sale to Pb-Cu smelter or disposal
	Slag	40–60	Road construction or disposal
	Flue-dust	30–80	Return slag External/internal recycling
Refining	Dross	70–120	Sale to metal recovery
All stages	Slag, flue-dust, etc.	500–550	Internal recirculation
⁽¹⁾ Short rotary furnaces may also be used in primary lead production to treat residues from refining. Source: [117, Krüger, J. 1999], [377, ILA 2013], [397, ILA 2012]			

Table 5.19: Residues from direct lead smelting processes

Production step	Product or process residue	Quantity (kg/t Pb)	Use or treatment option
Kivcet			
Smelter	Slag	700	Controlled disposal
	Flue-dust I	110	Return to smelter
	Flue-dust II	100	To zinc leach
	Steam	1300	Energy conversion
H ₂ SO ₄ plant	H ₂ SO ₄	1100	Sale
	Calomel	< 0.10	Sale
	Acid sludge	0.5	Controlled disposal
Water treatment	Sludge		
Kaldo			
TBRC (Kaldo)	Slag	350	To fuming
	Flue-dust	160	Return to smelter
	Steam	700	Energy conversion
H ₂ SO ₄ plant	H ₂ SO ₄	500	Sale
	Calomel		
	Acid sludge		
Water treatment	Sludge		
QSL			
Smelter	Slag	550	Road construction
	Flue-dust	60	Return to smelter
	Copper dross	100	After Cd leach Sale
	Steam	1300	Energy conversion
Refining	Silver	2	Sale
H ₂ SO ₄ plant	H ₂ SO ₄	700	Sale
	Calomel	0.02–0.05	Sale
	Acid sludge	0.5	Return to smelter
Dust leaching	CdZn precipitate	1.9	Controlled disposal
Water treatment	Sludge		Return to smelter or disposal ⁽¹⁾
All stages	Slag, flue-dust, sludges, etc.	130–150	Internal recirculation
Ausmelt/ISASMELT			
Smelter	Dross	125	Return to smelter ⁽²⁾
	ZnO dust	50	To zinc smelter
	Steam	NA	Energy conversion
H ₂ SO ₄ plant	H ₂ SO ₄	400	Sale
	Acid sludge	< 1	Return to smelter
	Hg precipitate	0.2	Calomel production
Dust leaching	CdZn precipitate	1.1	To zinc smelter
	Lead residue	40	Return to smelter
Water treatment	Sludge	< 5	Return to smelter or disposal ⁽¹⁾
All stages	Slag, flue-dust sludges, etc.	~ 420	Internal recirculation
Rotary rocking furnace processing flue-dust from primary copper smelter			
Smelter	Slag	1330	Return to copper smelter
	Speiss	36	Landfilled
	Dust	340	Return to lead smelter
	Product from semi-dry flue-gas neutralisation	115	Returned to copper smelter as flux, partially stored
⁽¹⁾ Depending on the value of the metals contained in the sludge. ⁽²⁾ Special campaigns for slag reduction. Source: [117, Krüger, J. 1999], [234, UBA (D) 2007], [305, Ausmelt 2009], [397, ILA 2012]			

5.2.4.2 Plastics from battery processing

Some battery processing plants also produce polypropylene and polyethylene from the crushed battery cases. The total plastic content accounts for 11–20 wt-% of lead produced [99, Hähre, S. 1998]. There are a number of plastics production plants designed specifically for this material and they produce granular polypropylene for a number of industrial and domestic applications, including automobiles, pipes and drainage, and components in domestic kitchens. Effective washing of the polypropylene fraction and separation of other plastic components such as ebonite or PVC is essential to produce products within specification.

5.3 Techniques to consider in the determination of BAT

The sections of this document entitled 'Techniques to consider in the determination of BAT' set out techniques generally considered to have the potential for achieving a high level of environmental protection in the industries within the scope of the document. The background to the way the techniques are described is given in Section 2.12 and Table 2.10.

This section presents a number of techniques for the prevention or reduction of emissions and residues as well as techniques for reducing the overall energy consumption. They are all commercially available. Examples are given in order to demonstrate techniques which illustrate a good environmental performance. The techniques that are given as examples are based on information provided by the industry, European Member States and the evaluation of the European IPPC Bureau. The general techniques described in Chapter 2 on common processes apply to a great extent to the processes in this sector and influence the manner in which the main and associated processes are controlled and operated.

5.3.1 Raw material reception, handling and storage

The techniques applied to reduce diffuse emissions from the reception, handling and storage of primary and secondary raw materials are considered in Chapter 2 (see Section 2.12.4.1) and in the Emissions from Storage BREF [290, EC 2006].

5.3.2 Material pretreatment

5.3.2.1 Techniques to prevent and reduce emissions from primary and secondary material preparation (excluding batteries)

Description

The techniques to consider are:

- enclosed conveyors or pneumatic transfer systems (see Section 2.12.4);
- enclosed equipment (see Section 2.12.4);
- mixing carried out in an enclosed building (see Section 2.12.4);
- dust suppression systems;
- pelletisation of raw materials (see Section 2.5.1.6);
- bag filter (see Section 2.12.5.1.4).

Technical description

For primary lead production, concentrates are mixed with other smelting materials and fluxes to produce a fairly constant feed. Feed blends can be prepared from dosing bin systems using belt weighers or loss-in-weight systems. Final mixing and homogenisation can take place in mixers, pelletisers or in conveying and metering systems. These processes can lead to dust emissions. Enclosed equipment and conveyors or pneumatic transfer systems are used for dusty material.

In secondary lead and tin production, a great variety of lead- and tin-containing drosses, ashes, matte, residues, electronic scrap and slag with broad ranges of all constituents are used as raw materials. A homogeneous feed to the furnaces can be obtained by mixing many individual fractions with each other. Mixing is done by conventional transport systems (trucks, wheel loaders) and automated overhead cranes. Mixing can also be done using dosing bins equipped with weighing devices. In some cases, the feed mix from these bins is fed to an intensive mixer or into a mixing drum, before charging to the furnace. Mixing can be carried out in an enclosed building. Additionally, the building may be equipped with dust suppression systems (e.g. water nebulisers or conventional spraying systems) and/or exhaust and dedusting systems for the mixing area, or even for the entire building. In existing plants with space restrictions, materials

can be mixed and also pretreated (e.g. cut) outside if the material is kept moist, by using dust suppression systems such as water sprays to prevent diffuse emissions. Fine materials can be pelletised. Pelletising areas are encapsulated and covered. Enclosed conveyors are used. Ventilation systems are applied, with subsequent dedusting in a bag filter.

Crushing, grinding and screening are also used to reduce the size of secondary raw material to make it suitable for further processing. These operations are potentially a source of dust emissions, and consequently require covering. Extraction and abatement systems are used, and the collected dusts are returned to the process. Dust suppression systems can be applied such as water sprays or fog systems.

General techniques applied to prevent and reduce diffuse emissions from primary and secondary material preparation are considered in Chapter 2 (see Sections 2.12.4.1 and 2.12.4.2). Within this subsection, only techniques associated with the performance of the associated dedusting equipment are considered.

Achieved environmental benefits

- Prevention and reduction of dust and metals emissions.
- Reduction in the use of raw materials, i.e. through reuse of the dedusted materials.

Environmental performance and operational data

At the KGHM Polska Miedź S.A. plant in Poland, copper smelter dusts from the off-gas handling systems of the electric furnace and the convertor furnaces are collected and transported in dedicated containers to the lead plant's storage tanks. Unloading is carried out pneumatically. Slurries from the shaft furnaces' Venturi-type off-gas handling system are transported in the form of a suspension through pipelines into the filter press container. Batch materials, such as dusts and cake from the filter press, are mechanically dosed in the required proportion into a warm mixer for mixing and blending. A batch of the blend is transported into containers above the furnaces. All the lead plant's transport devices are airtight to prevent dust emissions. The batch container, placed above the rotary rocking furnace, holds a sufficient portion of the lead material necessary for one production cycle. Iron scrap is stored in a separate storage container, and is fed to the furnaces by a special loading device.

At Aurubis Hamburg in Germany, a new covered storage area for bulk lead-containing secondary materials with integrated crushing, screening and enclosed conveyor belts was constructed in 2011. Fine and sludge-type feed materials are pelletised. The pelletising area is encapsulated and covered. Closed conveyors are used. Exhaust gases are directed to a bag filter.

The Metallo-Chimique plant in Belgium was designed with a covered storage area for dusty materials. Air suction is installed at roof level. The air is filtered by a bag filter (120 000 Nm³/h). Dust emission levels are kept under 0.5 mg/Nm³. This value is based on two 4-hour measurements (spot sampling) carried out in 2011. Since the beginning of 2009, all dusty materials have been stored and handled inside the building.

At Umicore Hoboken, stockpiling areas are frequently sprayed with water in order to keep the raw materials moist. Mixing is done by a front-end loader. Dusty materials are stored inside closed buildings and mixed with wet raw materials and water before they enter the mix.

The Weser-Metall bath smelting furnace in Nordenham in Germany predominantly uses fines as feed materials. These fines are delivered by barges (to their own pier), by railway wagons, and by trucks.

The extraction of feed material from the feed store is achieved by moving it with a pay-loader to a hopper charging a tube conveyor, which is a special belt conveyor rolled by a support system to a completely closed tube. The tube conveyor to the dosing bins and furnace is additionally housed to avoid wind.

The dosing bins are equipped with weighing belt devices for material extraction and feed mix preparation. The feed mix is transported to the furnace feed port by a closed tube conveyor. The dosing bins are dedusted by a bag filter (30 000 Nm³/h); dust emission levels of < 1 mg/Nm³ are reported.

Table 5.20 gives more data about emissions from the material pretreatment.

Table 5.20: Dust emissions from material preparation

Plant	Origin	Technique	Pollutant	Values (mg/Nm ³)			Monitoring frequency
				Min.	Avg.	Max.	
6	Storage hall	Bag filter	Dust	< 0.1	< 0.1	< 0.1	Once every 3 years
			Pb	< 0.1	< 0.1	< 0.1	
16	Storage hall	Bag filter	Dust	0.004	0.015	0.055	12 times per year
			Pb	< 0.01	< 0.01	< 0.01	
			Cd	< 0.01	< 0.01	< 0.01	
			Sb	< 0.01	< 0.01	< 0.01	
Secondary Plant A	Double roll crusher and hammer mill	Venturi scrubber	Dust	0.3	NR	0.8	Discontinuous measurements (2-hour average values)
			Pb	0.03	NR	0.14	
			Cd	< 0.005	NR	< 0.005	
			Sb	< 0.005	NR	< 0.005	
Secondary Plant B	Hydrosizer to separate plastics	Scrubber	Dust	0.5	NR	0.8	Discontinuous measurements (half-hourly average values)
NB: Dust limit of detection 0.3 mg/m ³ . Metals limit of detection 0.005 mg/m ³ . NR = Not reported. Source: [378, Industrial NGOs 2012], [385, Germany 2012]							

Cross-media effects

Enclosed conveyors or pneumatic transfer system

Increase in energy use.

Enclosed equipment

No information provided.

Mixing carried out in an enclosed building

- When dust suppression with water spraying is used, there is a significant increase in energy consumption in the smelting process due to the slight wetting of the material.
- The treatment of large volumes of air and high energy consumption are particularly associated with roof extraction systems.

Dust suppression systems

Increase in energy consumption in the smelting process due to the slight wetting of materials and generation of waste water.

Pelletisation of raw materials

Increase in energy use.

Bag filter

Increase in energy use.

Technical considerations relevant to applicability

Generally applicable, although for existing plants the applicability of a dedicated building to store and to mix dusty materials could be limited by space requirements and the need for an appropriate building design.

Pelletisation of raw material is only applicable when the furnace and the process are designed to deal with pelletised materials.

Building ventilation may be installed but it depends on different aspects such as the size of the particles, the size and use of the storage hall, and the individual emissions situation.

Economics

In 2007–2008, the Metallo-Chimique plant in Belgium invested around EUR 6.5 million in a covered storage area for dusty materials. The storage area measures 8000 m² and 180 000 m³ and has a maximum storage capacity of 20 000 tonnes. The maximum throughput of the hall is 50 000 t/yr. The pneumatic transport system for dry dusty materials uses double-walled pipes; in addition, a leak detection system has been in operation since 2010. The cost is determined primarily by the material throughput (approximately 36 000 t/yr) and the transport distance (120 m). The investment cost of around EUR 400 000 includes the injection system from silo to smelter, and double-walled pipes between the dryer and the silo and also between the silo and the smelter.

At Aurubis Hamburg, construction of a covered storage area (5000 m²) with an integrated crushing, screening and conveying facility connected to a bag filter (70 000 Nm³/h) involved a capital expenditure of EUR 7.5 million.

Driving force for implementation

Environmental regulation requirements.

Example plants

Metallo-Chimique (BE), Weser-Metall (DE), BSB Recycling (DE), Aurubis (DE), Umicore (BE), and KGHM (PL).

Reference literature

[397, ILA 2012]

5.3.2.2 Techniques to prevent and reduce emissions to air from primary and secondary material drying

Hot gas rotary dryers, steam coil dryers or hot air conveyor-type dryers or vacuum dryers can be used if the smelting process requires a dry feed, or a reduction in feed humidity (i.e. the moisture content is a limiting factor for the smelting process, and may need to be reduced). In addition, predrying of feed materials reduces the energy consumption during smelting, because evaporation of water at low temperatures requires less energy than high-temperature processing. Steam coil dryers use waste heat from other parts of the process provided the heat balance allows it.

Description

The techniques to consider are:

- enclosed conveyor or pneumatic transfer systems (see Section 2.12.4);
- enclosed equipment (see Section 2.12.4);
- bag filter (see Section 2.12.5.1.4);

- afterburner (see Section 2.12.5.2.1).

Technical description

General techniques applied to prevent and reduce diffuse emissions from primary and secondary lead and tin production are considered in Chapter 2 (see Section 2.12.4). Within this subsection, only specific information associated with the application and performance of the techniques listed is considered.

Enclosed equipment (see Section 2.12.4)

The dried material is usually very dusty. To prevent the release of this material into the environment, all the processes are enclosed, including the feeder and the gas extraction point, and enclosed conveyor or pneumatic transfer systems are used. The flue-gas emitted from the processes is then collected by the gas emission abatement plant, which is designed according to the pollutants present. The flue-gas system works under negative pressure to ensure that there are no gas emissions to air. Also, when diffuse emissions may arise from dried input materials, conveyor systems are enclosed and fitted with gas extraction systems.

Bag filter

All the data provided show that all plants in the EU-28 use a bag filter to abate the emissions of dust and metals (see Section 2.12.5.1.4).

Afterburner

If during the drying process CO and VOCs are produced, an afterburner is applied to abate these pollutants (see Section 2.12.5.2.1). A regenerative afterburner (RTO) may also be installed to reduce the energy consumption of the abatement system. In this case, a dedusting system is applied before the afterburner, to prevent the blockage of the ceramic bed.

Achieved environmental benefits

Enclosed conveyor or pneumatic transfer systems and enclosed equipment
Prevention of diffuse emissions.

Bag filter

- Reduction of dust and metals emissions.
- Reduction of raw material consumption, through recycling of the abated dust.

Afterburner

Reduction of VOCs and CO emissions.

Environmental performance and operational data

Bag filter

The dried material is usually very dusty and hence extraction and abatement systems are needed to collect dusty gases. Bag filters achieve better dust removal efficiencies than ESPs when used at this stage of the process. Collected dusts are returned to the process.

At Metallo-Chimique Beerse, dusty materials are discharged, stored and mixed in a closed storage hall (see Section 5.3.2.1). The mixed batches are then fed into the gas-fired rotating dryer by an automated overhead crane, via a vibrating feeder. This feeder is encapsulated and equipped with a vent system. The air is dedusted in a fabric filter before being released to the atmosphere. The fumes from the rotating dryer are filtered by a bag filter and treated in the stack by an afterburner to eliminate organic compounds. After drying, the dry product is sieved to produce a coarse fraction and a fine (< 2 mm) fraction. The coarse material is returned to the storage building by a covered rotating belt. The fine material is pneumatically transferred to a storage silo through double-walled pipes. The table below shows the emissions of dust from this plant in 2011 measured via spot sampling.

Table 5.21: Emissions from material drying in Metallo-Chimique Beerse

Furnace type	Production capacity	Heating	Off-gas treatment	Emissions	Monitoring frequency
Rotating dryer	15 t/h (2 t water/hour – water weight content before drying 12 %, after < 1 %)	Natural gas	Primary emission: bag filter + afterburner Secondary emissions: bag filter	Dust: 1–3 mg/Nm ³	Twice a year (4-hour sampling period)

Source: [397, ILA 2012]

In other plants, the feed materials are stored in an enclosed building fitted with an extraction system and are charged to the dryer by an overhead crane. The dried material is transferred by enclosed conveyor and extraction systems. Both the flue-gas from the dryer and the other gases are filtered through a bag filter.

At Aurubis Hamburg, fine and sludge-type feed materials are pelletised to prevent diffuse emissions and are then dried to less than 2–3 wt-% of water, with hot air in a conveyor-type dryer or a vacuum dryer. The flue-gas from the dryer is treated with a bag filter. Continuous dust measurement is undertaken; the observed dust levels in the years 2009–2011 are between 0.5 mg/Nm³ and 10 mg/Nm³ (half-hourly averages). As a wide range of secondary materials (e.g. dusts, drosses, slags, sludges) are processed, the minimum and maximum emission levels are highly influenced by the particle size, nature, composition and physical features, and the moisture content of the input material, abrasion of cleaning equipment and the age and wear of filter elements.

Table 5.22: Emissions from material drying in Aurubis Hamburg

Furnace type	Capacity	Heating	Off-gas treatment	Emissions
Hot air conveyor-type dryer	Up to 10 t/h	Hot air by steam	Bag filter	Continuous dust measurement, dust levels: 0.5–12 mg/Nm ³ (half-hourly average) 1.1–4.6 mg/Nm ³ (daily average)
Vacuum dryer	2 t/h	Natural gas	Bag filter	

Table 5.23 shows the data sent by ILA.

Table 5.23: Emissions from the drying process in primary and secondary lead and tin production

Plant	Technique	Pollutant	Unit	Values obtained under normal operating conditions			Monitoring frequency	Note (*)
				Min.	Avg.	Max.		
12	Bag filter	Zn	mg/Nm ³	0.179	0.234	0.269	Spot sample twice a year	s
		Pb	mg/Nm ³	0.037	0.046	0.052		
		Cu	mg/Nm ³	0.237	0.289	0.373		
		Cr	mg/Nm ³	0.049	0.086	0.195		
		Mn	mg/Nm ³	0.006	0.007	0.008		
		Sn	mg/Nm ³	0.018	0.023	0.026		
		Ni	mg/Nm ³	0.003	0.005	0.006		
		As	mg/Nm ³	< LOD	< LOD	< LOD		
		Cd	mg/Nm ³	0.01	0.013	0.014		
		Hg	mg/Nm ³	0.002	0.023	0.036		
	CO	mg/Nm ³	181	188	193			
		NO _x	mg/Nm ³	29	34	37		
		TVOC	mg/Nm ³	16	23.9	31.9		
PCDD/F		I-TEQ ng/Nm ³	0.18	0.18	0.18			
13	Bag filter	Dust	mg/Nm ³	1.8	2.3	2.7	Twice a year (4-hour averages)	s
		Sb	mg/Nm ³	0.0024	0.0027	0.0030		
		As	mg/Nm ³	0.0016	0.0017	0.0018		
		Cu	mg/Nm ³	0.5815	0.6270	0.6725		
		Cd	mg/Nm ³	0.0118	0.0195	0.0272		
		Pb	mg/Nm ³	0.0911	0.1008	0.1105		
		Ni	mg/Nm ³	0.0095	0.0103	0.011		
		Sn	mg/Nm ³	0.047	0.054	0.060		
16	Bag filter	Dust	mg/Nm ³	0.11	0.52	1.77	12 times a year	p & s
		Pb	mg/Nm ³	0.01	0.26	1.19		
		Cd	mg/Nm ³	< 0.01	< 0.01	< 0.01		
		Sb	mg/Nm ³	< 0.01	< 0.01	< 0.01		

(*) p is for primary lead plant.
s is for secondary lead and tin plant.
LOD = Limit of detection.
Source: [378, Industrial NGOs 2012]

Cross-media effects*Enclosed conveyor or pneumatic transfer systems*

None reported.

Enclosed equipment

No information provided.

Bag filter

- Increase in energy use.
- Waste may be produced if the collected dust cannot be returned to the process.

Afterburner

- Increase in NO_x emissions.
- Fuel is needed if the energy produced by the flue-gas oxidation is not sufficient to reach the required temperature.

Technical considerations relevant to applicability

Enclosed conveyor or pneumatic transfer systems

Generally applicable.

Enclosed equipment

Generally applicable.

Bag filter

Generally applicable.

Afterburner

This technique is applied for the reduction of CO and VOC emissions if there is a risk that at the process operating temperature the dried material may emit these pollutants.

Economics

Bag filter

An example of the costs associated with the installation of a bag filter and afterburner is given for the Metallo-Chimique plant in Beerse. In 2007–2008, for the treatment of the flue-gas from the dryer, the plant replaced the existing bag filter with a new one (19 500 Nm³/h). This involved an investment of EUR 665 000 (bag filter including afterburner in the chimney and the chimney itself). For secondary emissions, another bag filter (20 500 Nm³/h) was installed in 1994–1995 at a cost of EUR 400 000.

Driving force for implementation

Environmental regulation requirements.

Example plants

Metallo-Chimique (BE), Elmet (ES), Aurubis (DE), and Weser-Metall (DE).

Reference literature

[397, ILA 2012]

5.3.2.3 Techniques to prevent and reduce emissions from dismantling, sintering, briquetting and pelletising

Separation, dismantling, sintering, briquetting and pelletising help achieve control of the input to the smelting process and improve metal recovery processes. These operations are done to achieve smaller grain sizes with a higher specific surface or to agglomerate material as sinter, briquettes or pellets. Sintering is used to prepare concentrates for some of the smelting processes. Updraught and downdraught sintering machines can be used for this. Recent developments such as a steel belt sintering process may also be applied.

Description

Techniques to consider are:

- enclosed equipment with gas extraction (see Section 2.12.4);
- bag filter (see Section 2.12.5.1.4).

Technical description

General techniques applied to prevent and reduce diffuse emissions from primary and secondary lead and tin production are considered in Chapter 2 (see Section 2.12.4).

Briquetting and pelletising are applied to fine materials. To prevent diffuse emissions, pelletising areas are encapsulated and covered. Enclosed conveyors are used. Ventilation systems are applied with subsequent dedusting in a bag filter.

Milling, crushing and grinding techniques are used with a good dust extraction system and a bag filter.

The collection of fume and gases during sintering is important and the updraught sintering process can be applied inherently more easily for fume capture.

Achieved environmental benefits

Enclosed equipment with gas extraction

Prevention of dust emissions.

Bag filter

- Reduction of dust emissions
- Reduction in use of raw materials.

Environmental performance and operational data

At the Aurubis plant in Hamburg, fine and sludge-type feed materials are pelletised. Flue-dust is stored in closed silos before pelletising. The pelletising area is encapsulated and covered. Closed conveyors are used. Exhaust gases are directed to a bag filter.

Cross-media effects

Enclosed equipment with gas extraction and bag filter

Increase in energy use.

Technical considerations relevant to applicability

Enclosed equipment with gas extraction

Generally applicable.

Bag filter

Generally applicable.

Economics

No information provided.

Driving force for implementation

Environmental regulation requirements.

Example plants

Aurubis (DE).

Reference literature

[397, ILA 2012]

5.3.2.4 Techniques to prevent and reduce emissions from battery preparation

Description

The techniques to consider are:

- enclosed equipment and gas extraction system (see Section 2.12.4);
- bag filter (see Section 2.12.5.1.4);
- wet scrubber (see Sections 2.12.5.1.6 and 2.12.5.2.2);
- acid-resistant floor surface and system for the collection of acid;
- acid recovery or reuse;
- acid mist treatment in the waste water treatment plant.

Technical description

Enclosed equipment and gas extraction system (see Section 2.12.4)

Dust and acid mist emissions from battery crushing, screening and wet classifying are collected and passed to an abatement system such as a bag filter or wet scrubber.

Bag filter (see Section 2.12.5.1.4)

Mist filters need to be installed when a flue-gas with acid mist is sent to a bag filter.

Wet scrubber (see Sections 2.12.5.1.6 and 2.12.5.2.2)

A wet scrubber is used for the abatement of dust and acid mist. The scrubbing water is sent to the waste water treatment plant to treat the collected drained and diluted acid from the batteries. Metals are removed by neutralisation and precipitation with Na_2CO_3 and by addition of flocculants. The residue is sent to the smelter.

Acid-resistant floor surface and system for the collection of acid

The acid content of the batteries can contaminate land and water. For this reason, the floor surface of the battery preparation plant should be protected by an acid-resistant layer which is connected either to waste acid tanks or to an effluent treatment plant. All the equipment used should be acid-resistant.

Acid recovery or reuse

See Section 5.3.7.2.

Acid mist treatment in the waste water treatment plant

No information provided.

Achieved environmental benefits

Enclosed equipment and gas extraction system

Prevention of gas emissions and acid leakage.

Bag filter

Reduction of dust emissions.

Wet scrubber

Reduction of dust and acid mist emissions.

Acid-resistant floor surface and system for the collection of acid

Prevention of soil and water contamination.

Acid recovery or reuse

- Reuse of secondary material.
- Prevention of emissions to water.

Acid mist treatment in the waste water treatment plant

Reduction of acid emissions and reduction of emissions to water.

Environmental performance and operational data

At one German plant, the spent batteries are pre-crushed in a double roll crusher. Afterwards, the crushed material passes through a magnetic separation stage and is finally fed into a hammer mill for further crushing. Off-gases from the double roll crusher and hammer mill are extracted and dedusted in a Venturi scrubber. The separated sulphuric acid is further processed to produce gypsum. Dust emissions of between 0.32 mg/Nm^3 and 0.8 mg/Nm^3 (spot sample), and lead emissions of between 0.031 mg/Nm^3 and 0.14 mg/Nm^3 (spot sample) are reported [385, Germany 2012].

At Plant 7, several steps are taken to separate lead paste, lead metal, sulphuric acid, and polypropylene and other plastics. Flue-gases from hydrosizers are treated in a scrubber. Dust emissions of between 0.5 mg/Nm³ and 0.9 mg/Nm³ are reported [385, Germany 2012].

Table 5.24 and Table 5.25 show the emissions to air and water from four plants that apply some of the techniques described above.

Table 5.24: Emissions to air from battery preparation

Plant	Technique	Pollutant	Uncertainty (%)	Values (mg/Nm ³)			Monitoring frequency
				Min.	Avg.	Max.	
5	Wet scrubber	Dust	40	0.18	0.59	0.9	4 times in 2011 (4-hour averages)
		Lead and compounds	40	0.097	0.591	0.903	
		Cadmium and compounds	40	0.001	0.001	0.002	
		Cu, Pb, Zn, Ni and compounds	40	0.099	0.205	0.343	
		Sb, Sn, Te and compounds	40	0.003	0.005	0.007	
		Cd, As, Hg, Tl, Se and compounds	40	0.004	0.018	0.054	
6	Bag filter	Dust ⁽¹⁾	NR	< 0.5	< 0.5	< 0.5	Every 3 years
		Pb ⁽¹⁾	NR	< 0.1	< 0.1	< 0.1	
		As+Cd ⁽¹⁾	NR	< 0.05	< 0.05	< 0.05	
7	Scrubber	Dust	NR	< 0.5	0.5	0.9	Continuous measurement (Daily averages)
		Pb	NR	< 0.5	< 0.5	< 0.5	4 times a year
19	Emissions from battery breaking	Dust	NR	0.2	0.5	1	Once a year
⁽¹⁾ Measurements performed in 2011. NR = Not reported. Source: [378, Industrial NGOs 2012], [393, Austria 2012]							

Table 5.25: Emissions to water from battery preparation in Plant 5

Origin	Waste water treatment	Pollutant	Uncertainty (%)	Values (kg/d)			Monitoring frequency
				Min.	Avg.	Max.	
Process water; surface run-off water; process area for lead recovery from secondary sources	pH adjustment	Pb	16	0.06	0.57	1.45	24-hour periodic composite sample
	Ferric chloride addition	Cd	12	0.003	0.115	0.552	
	-	Sb	20	0.002	0.212	1.096	
	Flocculation and settlement	As	25	0.001	0.018	0.092	
	-	Cu	10	0.001	0.017	0.046	
	Anionic/cationic flocculation	Hg	25	0.001	0.002	0.009	
	-	Ni	10	0.001	0.130	0.428	
	Mechanical filtration	NH ₄ ⁺	25	0.21	2.478	6.17	

Source: [378, Industrial NGOs 2012]

Cross-media effects

Enclosed equipment and gas extraction system

No information provided.

Bag filter

- Increase in energy use.
- Waste may be produced if the dust cannot be returned to the process or be reused as raw material.

Wet scrubber

- Increase in energy use.
- Waste water is produced that needs additional treatment to prevent the discharge of acid and metals to water.

Acid-resistant floor surface and system for the collection of acid

No information provided.

Acid recovery or reuse

Increase in energy use.

Acid mist treatment in the waste water treatment plant.

- Increase in energy use.
- Use of chemicals.

Technical considerations relevant to applicability

Enclosed equipment and gas extraction system

Generally applicable.

Bag filter

Generally applicable.

Wet scrubber

Generally applicable. Waste water is produced that needs additional treatment to prevent the discharge of acid and metals to water.

Acid-resistant floor surface and system for the collection of acid

Generally applicable.

Acid recovery or reuse

See Section 5.3.7.2.

Acid mist treatment in the waste water treatment plant.

Applicable only for plants with an adequate waste water treatment plant.

Economics

Increased investment costs due to the need for additional specific infrastructure and equipment.

Driving force for implementation

Environmental regulation requirements.

Example plants

Harz-Metall (DE), BSB Recycling (DE), Muldenhütten Recycling und Umwelttechnik (DE), and BMG Metall und Recycling GmbH (AT).

Reference literature

[397, ILA 2012]

5.3.2.5 Technique to reduce sulphur gas emissions from the smelting process

Description

Alkaline leaching uses an alkali salt solution to remove sulphates from secondary materials prior to smelting.

Technical description

Secondary materials containing sulphur can cause the emission of this pollutant during smelting. An example of this is lead-acid battery paste. This can contain a range of lead compounds, some of which contain sulphur, such as PbSO₄. To prevent or reduce SO₂ emissions during the smelting process, sulphur present as sulphates can be removed by alkaline leaching of the material, prior to the smelting operation.

The desulphurisation of lead-acid battery paste by reaction with an alkali solution (sodium carbonate or sodium hydroxide) is described in the simplified chemical reactions below:

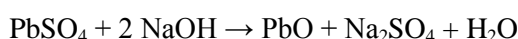
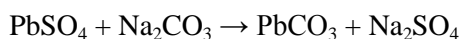

The reactions occur quickly and the conversion efficiency is very high. The desulphurised material is then fed into the furnace. The process flow diagram is shown in Figure 5.4.

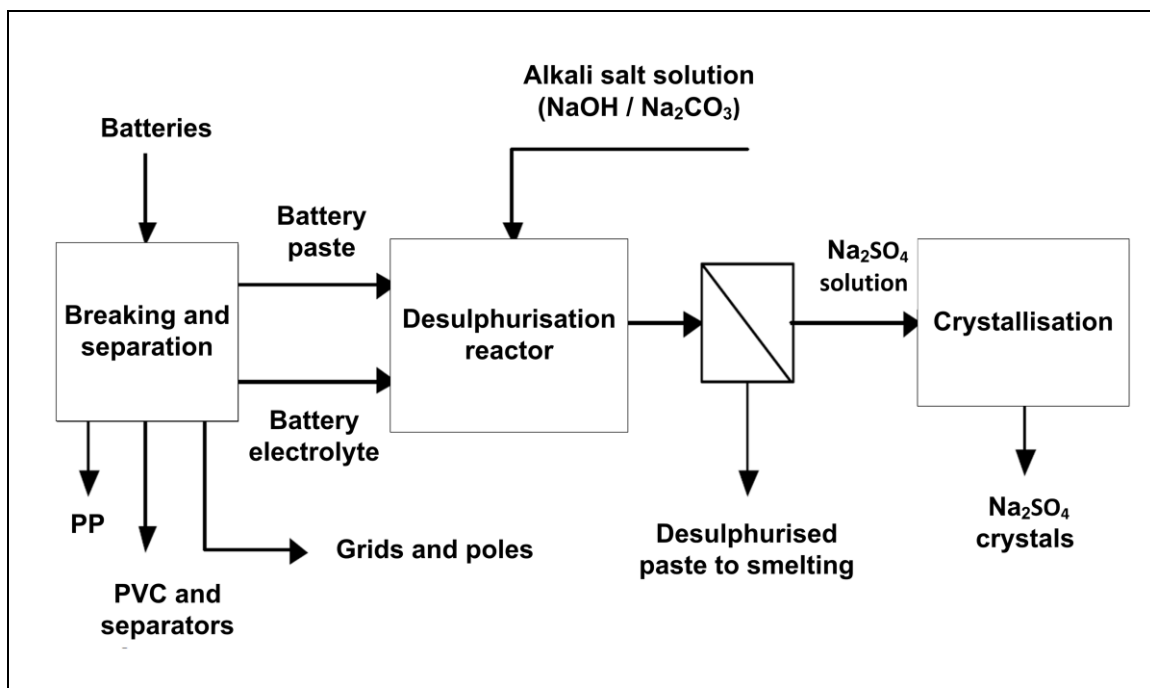

Figure 5.4: Flow diagram of desulphurisation of battery paste by alkaline leaching

Battery electrolyte (acid) may also be separated for reuse, rather than passing it to the desulphurisation reactor to form sodium sulphate.

The sodium sulphate solution produced by the process can be treated in two ways, depending on local environmental conditions, economics and product specification requirements:

- recovery of sodium sulphate by crystallisation;
- disposal of the sodium sulphate solution after removal of other impurities (e.g. metals).

When sodium sulphate is recovered from the solution by crystallisation, the water entering the process is recycled and no liquid effluents are generated. However, this is only possible where there is a market for the recovered sodium sulphate. This is not always the case and depends on local market conditions and the quality specifications required for the product. If commercialisation is not possible, disposal is necessary.

The area where this activity takes place in the plant is usually provided with an impermeable and acid- (or sulphate-)resistant layer, to resist any occasional leakage of corrosive liquids or salts. Spills and cleaning water pass to the waste water treatment plant, if not recycled.

Achieved environmental benefits

- Reduction of SO_2 emissions during the smelting.
- Reduction in the consumption of smelting additives, and reduction of slag and lead loss in the slag.
- Reduction in energy consumption for the smelting, due to less material being melted.

Environmental performance and operational data

Alkaline leaching is a hydrometallurgical process carried out without heating, at approximately 50°C , which results in an exothermic reaction. A wet desulphurised filter cake is produced. As such, no dust is emitted from this operation. If a dry feed for the furnace is required, an additional drying step needs to be introduced between the leaching step and the smelting step. As far as the consumption of reactant is concerned and considering, for example, a lead-acid battery paste with a standard composition, 220 kg of Na_2CO_3 per tonne of lead produced from

batteries (also considering the acid neutralisation) is required to produce about 280 kg of Na₂SO₄ per tonne of lead. Under these conditions, the sulphur removal is high.

Table 5.26 shows the SO₂ emissions from a plant that applied this technique.

Table 5.26: Emissions from rotary furnaces fed with desulphurised raw materials

Origin	Technique	Pollutant	Unit	Values			Monitoring frequency
				Min.	Avg.	Max.	
Rotary furnace	Alkaline leaching	SO ₂	mg/Nm ³	< 10	109	375	Continuous/ Charge
Rotary furnace	Alkaline leaching	SO ₂	mg/Nm ³	< 10	134	NR	Continuous/ Charge
Rotary furnace	Alkaline leaching	SO ₂	mg/Nm ³	150	350	480	Continuous/ Daily average
Tilting rotary furnace	Alkaline leaching	SO ₂	mg/Nm ³	< 20	66	148	Continuous/ Extractive
NB: NR = Not representative. Source: [378, Industrial NGOs 2012]							

Cross-media effects

- Use of chemicals (Na₂CO₃, NaOH).
- Production of waste if the sulphate cannot be converted into a commercial product.
- Increase in energy consumption due to the required additional process step.

Technical considerations relevant to applicability

The technique is only applicable for materials containing sulphur in the form of sulphates, and requires additional and dedicated equipment to be installed.

Crystallisation has the advantage of producing Na₂SO₄ as well as allowing the recycling of water, thus leading to a significant improvement in the water balance. However, this is only possible where there is a market for the recovered sodium sulphate. This is not always the case and depends on local market conditions and the quality specifications required for the product. If commercialisation is not possible, disposal is necessary.

Economics

Possible positive cost reductions for smelting will be offset against the higher costs associated with the required additional process steps for desulphurisation prior to the furnace charge.

Driving force for implementation

- Environmental regulation requirements.
- Reduction of the cost of a gas treatment system.
- Reduction in the use of smelting additives; less slag production and lower loss of lead in the slag.
- Reduction in fuel consumption for the furnace process as less material is required for melting.
- Higher furnace productivity (+ 20–30 % in the case of lead battery paste).

Example plants

BMG Metall und Recycling (AT) and Muldenhütten Recycling und Umwelttechnik (DE).

Reference literature

[237, UBA (A) 2004], [266, Italy 2008], [397, ILA 2012]

5.3.3 Lead production using primary and secondary materials (primary smelters)

5.3.3.1 Techniques to prevent and reduce emissions to air from primary smelter process gases

Description

The techniques to consider are:

- enclosed/encapsulated equipment (see Section 2.12.4);
- hot ESP (see Section 2.12.5.1.1);
- wet ESP (see Section 2.12.5.1.2);
- bag filter (see Section 2.12.5.1.4);
- mercury removal (see Section 2.12.5.5);
- sulphuric acid plant (see Sections 2.12.5.4.1 and 2.12.5.4.2);
- wet scrubber (see Sections 2.12.5.1.6 and 2.12.5.2.2).

Technical description

Enclosed/encapsulated equipment (see Section 2.12.4)

To prevent emissions to the environment, enclosures are used, such as:

- encapsulated charging systems (double bell, door sealing, closed conveyors and feeders);
- sealed or enclosed furnaces;
- operation under negative pressure and a sufficient gas extraction rate to prevent the pressurisation of the furnace.

Before sending the flue-gases emitted from the primary smelter to the sulphuric acid plant, they are cleaned carefully to remove dust and gaseous contamination. This protects the catalyst and produces a good quality sulphuric acid.

The typical order of this process is as follows:

- Firstly, use of a dust retention system with a hot gas ESP followed by a wet ESP. Dust from the hot gas ESP is returned to the process, after leaching out chloride or cadmium, if necessary.
- Secondly, after the wet ESP, the gas passes through a mercury removal system. Mercury recovery systems are employed using one of the techniques discussed in Section 2.12.5.5. The content of mercury in the off-gases has to be very low to ensure a good quality sulphuric acid is produced. Residues from the wet ESP and mercury removal are landfilled, if not used for other processes.
- Thirdly, after the mercury recovery, the gas is sent to the sulphuric acid plant. Sulphuric acid plants are described in Sections 2.12.5.4.1 and 2.12.5.4.2.
- A wet scrubber is used to reduce the emissions of dust, if used before the sulphuric acid plant, or SO₂, as a tail gas scrubber, after the sulphuric acid plant.

Gases with a high SO₂ content are fairly low volume compared to the other streams.

The separated dust/residues are recycled internally or externally for metal recovery; sometimes after a pretreatment for the removal of chlorides, cadmium and/or other undesired contents.

When electric furnaces are used, the off-gas is afterburnt, cooled, filtered in a bag filter and treated in a mercury removal plant, before entering a sulphuric acid plant without additional washing and cooling.

Achieved environmental benefits

Enclosed/encapsulated equipment

Prevention of diffuse emissions.

Hot ESP

- Reduction of dust and metals emissions.
- Recovery of raw materials.

Wet ESP

Reduction of dust and mercury emissions.

Bag filter

- Reduction of dust and metals emissions.
- Recovery of raw materials.

Mercury removal system

Abatement of mercury.

Sulphuric acid plant

- Reduction of SO₂ emissions.
- Recovery of sulphur.

Wet scrubber

Reduction of dust and SO₂ emissions.

Environmental performance and operational data

Mercury (total) concentration prior to filtration can range from 10 µg/m³ to 9900 µg/m³, and after filtration from 3 µg/m³ to 50 µg/m³, representing 70 % to 99.7 % removal, subject to the mercury removal technologies employed.

At Aurubis Hamburg, an enclosed electric smelting furnace (13.5 MW and 8.4 metres in diameter) is used to process primary lead concentrates. The electric furnace process' off-gas is cooled with recirculated cold gas and by an air-to-gas cooler. Cooled gases are transferred to a bag filter, and then to a mercury removal step, and finally to the acid plant.

The Ausmelt furnace of Weser-Metall in Nordenham consists of a vertical standing cylinder (10 metres in height, 4 metres in diameter) with a top submerged lance for supplying natural gas and oxygen-enriched air as process gas. Sulphur-containing primary and secondary materials are melted down to generate lead bullion, lead oxide concentrate, and SO₂, and dust-containing off-gas (6–10 % SO₂). The off-gas is cooled down in a waste heat boiler and passes through a hot ESP with an exit temperature of about 240 °C. It is then quenched in a Venturi scrubber to 80 °C, passes through a first row of wet ESPs, a packed bed washing tower and finally a second row of wet ESPs to remove the residual dust contained. The clean cool gas then passes a mercury removal step (packed bed countercurrent washing tower) before it enters the five-stage contact plant for converting SO₂ to sulphuric acid. The average daily emissions of SO₂ (measured continuously) are from 160 mg/Nm³ to 750 mg/Nm³, with an average of 470 mg/Nm³.

Table 5.27 shows the emissions of Plant 8, which uses a combination of the techniques described above.

Table 5.27: Emissions from the furnace in Plant 8

Technique	Pollutant	Unit	Yearly average	Monitoring frequency
Double contact/double absorption with BAYQIK®	SO ₂	mg/Nm ³	490	Continuous measurement (half-hourly averages)
<i>Source: [378, Industrial NGOs 2012]</i>				

The top submerged lance (TSL) Ausmelt furnace at KCM's new (2013) lead plant in Bulgaria (Plovdiv) is operated batch-wise in three repetitive stages, namely:

- smelting (approximately 7 hours);
- reduction (approximately 1.5 hours);
- standby burner/lance hold (approximately 1 hour).

The furnace is designed to meet the availability requirements of 7008 hours per year or 738 batches per year (each batch includes all three operational stages: smelting, reduction, standby/lance hold).

The furnace processes primary (lead concentrates) and secondary materials (battery paste and recycled materials mainly from pyrometallurgical lead refining) to produce 74 500 tonnes per year of lead bullion.

The flue-gases emitted from the smelter are collected using a sealed (TSL) Ausmelt furnace and, before sending them to a wet sulphuric acid plant, these gases are cleaned carefully to remove dust and gaseous contamination using the following equipment:

- a quench tower, to cool down the gas to the adiabatic saturation temperature and remove a first portion of the dust;
- wet scrubber with adjustable pressure drop, which achieves the required dust removal efficiency under all process conditions;
- clarifier/thickener to limit the solids content in the circulating liquid and send a thickened slurry to the dewatering system (filter press);
- slurry tank, to collect the underflow from the clarifier/thickener;
- another cooling tower, which cools down the gas to the final temperature before entering the sulphuric acid plant;
- sodium silicate dosing system, to bring down the fluoride content in the off-gas to acceptable levels for the wet sulphuric acid plant inlet;
- two wet ESPs (two stages in series), to remove final dust impurities and acid mist with a dedicated flushing water tank;
- two wet gas fans (one in operation and one on standby), to control the necessary furnace draught during standby, or start-up and/or emergencies;
- during the tapping/lance hold phase, a bypass fan, to recycle a portion of the gas after the wet gas fan to the wet scrubber in order to maintain a defined minimum gas flow to produce a pressure drop in the scrubber itself and ensure steady draught control.

The tail gases from the sulphuric acid plant are sent to a reverse jet scrubber. As SO₂ is absorbed by the circulating scrubbing liquid, the pH of the liquid drops. Lime milk (Ca(OH)₂) is added at pH control to maintain the ability to continuously remove SO₂ from the gas stream. The absorbed SO₂ reacts with the lime and produces calcium sulphite/sulphate slurry.

After the waste heat boiler (inlet to wet gas cleaning plant), the SO₂ content ranges from 0.32 vol-% (reduction stage) to 6.48 vol-% (smelting stage). During the tapping stage (standby/lance hold), no SO₂ is generated.

The wet sulphuric acid plant at the new KCM (Plovdiv) lead plant is designed to capture and convert incoming SO₂ in the smelting stage with an efficiency of at least 99.8 %, resulting in a SO₂ emission level from the tail gas scrubber of less than 2.6 kg/tonne of acid produced (as 100 % H₂SO₄), and in all cases resulting in a SO₂ emission level from the tail gas scrubber of no more than 400 mg/Nm³. In fact, the guaranteed SO₂ emission for this installation is no more than 110 ppmv (dry basis) which is equal to 322 mg/Nm³ (dry). Note that the '2.6 kg SO₂/tonne of 100 % acid produced' requirement is less stringent than the 99.8 % conversion requirement.

Due to the low SO₂ content in the off-gas during the reduction stage, the requirements for 99.8 % conversion or 2.6 kg SO₂/tonne of acid produced are not practical, as they result in SO₂ levels that are difficult to measure or unachievable (< 10 ppmv or 29.3 mg/Nm³). The expected SO₂ emission from the tail gas scrubber during the reduction stage is then quoted as < 10 ppmv, or < 29.3 mg/Nm³.

Table 5.28 shows the expected capture of the incoming SO₂ in the sulphuric acid plant.

Table 5.28: SO₂ emissions from the wet sulphuric acid plant at KCM's new lead plant in Plovdiv

Stage	Stack flow rate	Time	SO ₂ , (dry)	SO ₂ , (dry)	SO ₂ capture	SO ₂ emission
Unit	Nm ³ /h dry	h	mg/Nm ³	ppmv	%	kg/cycle
Smelting	~ 37 950	7	< 322	< 110	99.8	< 85.54
Reduction	~ 21 700	1.5	< 29.3	< 10	-	< 0.95
Hold-Tapping	-	1	-	-	-	0
Total	-	9.5	-	-	-	< 86.49

Source: [377, ILA 2013], [397, ILA 2012]

Cross-media effects

Enclosed equipment

No information provided.

Hot ESP

Increase in energy use.

Wet ESP

- Increase in energy use.
- Waste water is produced that should be treated to prevent the discharge of metal and other substances to water.
- Residues are landfilled.

Bag filter

- Increase in energy use.
- Waste may be produced if the collected dust cannot be returned to the process. When dust is to be returned to the process, treatment needs to be carried out to remove impurities.

Mercury removal

- Increase in energy use.
- Use of additives.
- A solid or liquid waste is produced that needs to be landfilled.

Sulphuric acid plant

See Sections 2.12.5.4.1 and 2.12.5.4.2. The cross-media effects depend largely on the techniques used for the production of sulphuric acid.

Wet scrubber

Waste water is produced that needs to be properly treated to prevent the discharge of metals and other pollutants into the receiving water. Residues need to be treated.

Technical considerations relevant to applicability

Enclosed/encapsulated equipment

Generally applicable.

Hot ESP, wet ESP, bag filter, mercury removal system

Generally applicable. The combination of techniques depends on the flue-gas characteristics.

Sulphuric acid plant

Applicable to flue-gas containing more than 1 wt-% SO₂. Alternatively, recovery of SO₂ in a double contact/double absorption acid plant is applied for furnaces processing a combination of primary and secondary materials or if there are primary and secondary smelters at one site.

Wet scrubber

Waste water is generated that needs to be properly treated before discharge. The applicability of the wet scrubber may be also limited by very high waste gas flow rates and in arid areas by the large volume of water necessary.

Economics

Aurubis Hamburg reports that investment costs for the installation of a mercury removal plant are up to EUR 5 million (condenser, heaters, bag filter, injection system, absorber and fans) [[397, ILA 2012](#)].

Investment costs for the installation of a waste heat boiler (radiation section only) are up to EUR 5.1 million (KCM's new lead plant in Plovdiv) [[397, ILA 2012](#)]

Investment costs for the installation of a wet gas cleaning plant, followed by a wet sulphuric acid plant, are up to EUR 20 180 000 (quench tower, radial flow scrubber, cooling tower, clarifier/thickener, underflow slurry tank, sodium silicate dosing system, wet ESP, wet gas fans, bypass fan, start-up/emergency stack; wet sulphuric acid plant: main gas blower, gas preheating, molten salt heat recovery system, reactor, concentration column, sulphuric acid system, wet ESP, tail gas scrubber, final stack) (KCM's new lead plant in Plovdiv) [[397, ILA 2012](#)]

Driving force for implementation

- Environmental regulation requirements.
- Recovery of sulphur.

Example plants

Aurubis (DE), Weser-Metall (DE), new KCM lead plant (BG), and Plant 8.

Reference literature

[[117, Krüger, J. 1999](#)], [[305, Ausmelt 2009](#)], [[397, ILA 2012](#)]

5.3.3.2 Techniques to prevent and reduce diffuse emissions in primary lead production from charging, tapping, and pre-decuppering

Description

The techniques to consider are:

- encapsulated charging systems;
- hoods/enclosures at charging and tapping points (see Section 2.12.4);
- enclosed equipment with flue-gas extraction and operating the furnace and flue-gas route under negative pressure (see Section 2.12.4);
- local ventilation system for charging and tapping areas, with a final dedusting step in a bag filter (see Section 2.12.5.1.4);
- enclosed building (see Section 2.12.4);
- maintain furnace sealing (see Section 2.12.4);
- hold temperatures in the furnaces at the lowest required level (see Section 2.12.4).

Technical description

In order to prevent diffuse emissions during charging, tapping, and pre-decuppering, an enclosure or hoods for capturing gases are applied at the emission sources. The captured off-gases are cleaned using a bag filter.

Detailed descriptions of the techniques applied for off-gas collection to prevent diffuse emissions are reported in Section 2.12.4.

Achieved environmental benefits

Prevention and reduction of dust and metals emissions.

Environmental performance and operational data

The Weser-Metall Ausmelt furnace in Nordenham is completely housed. The building's ridge turrets are connected with a fabric filter. The feed port and feed belt are emptied by a small filter system with star-shaped cartridges.

The slag is continuously tapped from the furnace and drains into a jet of water for granulation. Moist and dry fumes are extracted by a fan connected to a wet ESP (10 000–12 000 m³/h).

At the bottom level of the furnace, there are four kettles for copper removal (decuppering). All the kettles are suitably sealed, with a steel cover providing openings through which to manipulate the stirrer and dross scrapers. The cover has a suction opening, with a pipe connection to a bag filter. The bag filter also dedusts the off-gas from the lead taphole.

For dross removal, an encapsulated scraper or screw is used, linked to a small steel container. The container is emptied by a mobile tube, which is connected to a vacuum cleaner. A full container is covered with a steel lid and then moved outside the building by crane. For that, the normally closed crane door in the building opens. The container is transported by a forklift to the feed store for dross storage.

The cleaned off-gases from the wet ESP and bag filter are merged and controlled continuously for dust and SO₂ emissions.

The bag filter capacity is 111 000 Nm³/h with a 1400 m² filter area and 748 bags. The 2010 average emissions were: 0.66 mg/Nm³ of dust, 0.39 mg/Nm³ of lead, and 230 mg/Nm³ of SO₂.

At Aurubis Hamburg, an enclosed electric smelting furnace is used with an encapsulated lift charging system. The top of the furnace is placed under enclosure. Capture hoods are installed for all tapping areas. Secondary gases from the electric furnace are collected and dedusted in a bag filter.

Table 5.29 below gives the emission levels achieved after treatment of secondary gas from an electric furnace. Variations of dust and SO₂ concentrations are due to the batch-wise operation of tapping slag and metal. Data are from continuous measurements and represent long-term normal operation under different conditions, such as variability of input material, various loads and operating regimes, abrasion of equipment, or wear of filter elements.

Table 5.29: Secondary emissions from an electric furnace in Plant 18

Origin	Technique	Pollutant	Values (mg/Nm ³)		Monitoring frequency
			Minimum	Maximum	
Secondary gas from electric furnace	Bag filter	Dust	< 0.5	5.5	Continuous (half-hourly average)
		Dust	< 0.5	4.2	Continuous (daily average)
		SO ₂	< 50	840	Continuous (half-hourly average)
		SO ₂	< 50	800	Continuous (daily average)
		Cu	< 0.01	0.2	Discontinuous (4 times a year)
		Pb	< 0.01	0.2	
		Ni	< 0.01	0.1	
		As	< 0.01	0.02	
Cd	< 0.02	< 0.02			

And in Table 5.30 secondary emissions from furnaces in Plant 17 are shown.

Table 5.30: Secondary emissions from furnaces in Plant 17

Technique	Pollutant	Values (mg/Nm ³)			Uncertainty (%)	Monitoring frequency
		Min.	Avg.	Max.		
Bag filter (*)	Dust	1	1.1	5	10	12 times a year
	Cu	0.002	0.006	0.4	30	
	Pb	0.3	0.458	2.8	20	
	As	0.03	0.037	0.6	50	
	Cd	0.006	0.014	0.1	20	
	SO ₂	0	3.4	38	10	
	NO _x	0	2.3	13	10	
	H ₂ S	0.0	1.28	4.5	20	
	CS ₂	0.0	0.45	1.5	15	
Bag filter (**)	Dust	1	1.1	5	10	12 times a year
	Cu	0.002	0.006	0.05	30	
	Pb	0.3	0.462	3.5	20	
	As	0.03	0.042	0.75	50	
	Cd	0.006	0.014	0.1	20	
	SO ₂	9	16.9	38	10	
	NO _x	0	4.1	20	10	
	H ₂ S	0.0	0.87	4.5	20	
	CS ₂	0.0	0.19	1.6	15	

(*) Emissions from: rotary furnace body, crude lead casting, charge bins, tanks in the dust retention hall, batch loading tanks, loading scrap, storage tanks.
(**) Emissions from: connection of furnaces and combustion chambers, tapping from the combustion chambers.

Cross-media effects*Hoods*

No information provided.

Enclosed equipment with flue-gas extraction

No information provided.

Bag filter

- Increase in energy use.
- Waste may be produced if the collected dust cannot be returned to the process.

Technical considerations relevant to applicability

Generally applicable.

Economics

No information provided.

Driving force for implementation

Environmental and health regulations.

Example plants

All primary lead-producing plants in Europe.

Reference literature

[117, Krüger, J. 1999], [305, Ausmelt 2009], [397, ILA 2012]

5.3.3.3 Techniques to prevent and reduce diffuse emissions to air in primary lead production from slag treatment

Description

The techniques to consider are:

- slag storage in silos or use of water sprays for outdoor storage;
- enclosed equipment and hood with flue-gas extraction (see Section 2.12.4);
- bag filter (see Section 2.12.5.1.4);
- wet ESP (see Section 2.12.5.1.2).

Technical description*Slag storage in silos or use of water sprays for outdoor storage*

To prevent the emission of dust during the storage and the handling of the slag, the water spray system is installed to ensure that all the slag heaps are kept moist.

Enclosed conveyor belts connected with silo storage are also used.

For the other techniques, see the sections referred to above.

Achieved environmental benefits*Slag storage in silos or use of water sprays for outdoor storage and enclosed equipment and hood with flue-gas extraction*

Prevention of dust and metals emissions.

Bag filter

Reduction of dust and metals emissions.

Environmental performance and operational data

Slag produced from the QSL furnace is granulated with water. The wet slag is used for construction purposes.

The Weser-Metall Ausmelt furnace in Nordenham produces a saleable lead concentrate of metallurgic origin with 40–60 % lead. Campaign-wise, it is possible to treat this concentrate for the production of low-lead slag.

The Nordenham lead (oxide) concentrate is produced by water granulation of the liquid slag being tapped from the furnace. The fines are washed away with the granulation water to a collection basin with a trough chain conveyor, which extracts the fines to a rubber belt conveyor. The conveyor belt is linked to a double silo store, where the slag is intermediately stored. No further treatment is carried out.

Moist and dry fumes from the granulator are sucked out by a fan connected to a wet ESP (10 000–12 000 m³/h). The cleaned gas is controlled together with other fumes from the decoppering filter (for composition see Section 5.3.3.2).

In Germany, emissions of dust from primary lead plants of < 1 mg/Nm³ were recorded.

Cross-media effects

Slag storage in silos or use of water sprays for outdoor storage

- Increase in water and energy use.
- The run-off water from the sealed floor of the storage area, if not reused, has to be treated in the waste water treatment plant.

Enclosed equipment and hood with flue-gas extraction

No information provided.

Bag filter and wet ESP

- Increase in energy use.
- Waste may be produced if the collected dust cannot be returned to the process.

Technical considerations relevant to applicability

Generally applicable.

Economics

No information provided.

Driving force for implementation

Environmental regulation requirements.

Example plants

All primary lead production plants in Europe.

Reference literature

[117, Krüger, J. 1999], [397, ILA 2012]

5.3.4 Lead and tin production using secondary materials (secondary smelters)

5.3.4.1 Techniques to prevent and reduce diffuse emissions to air in secondary lead and tin production

Description

The techniques to consider are:

- hoods (see Section 2.12.4);
- enclosed equipment with flue-gas extraction (see Section 2.12.4);
- 'house-in-house' system (see Section 2.12.4);
- hold temperatures in the furnace at the lowest level (see Section 2.12.4);
- operate under negative pressure and with sufficient gas extraction to prevent pressurisation of the furnace (see Section 2.12.4);
- bag filter (see Section 2.12.5.1.4).

Technical description

In order to prevent diffuse emissions during charging, tapping, and pre-decuppering, enclosures or hoods for capturing gases should be applied at emission sources. The captured off-gases should be cleaned using a bag filter.

Detailed descriptions of the techniques applied to prevent diffuse emissions and for off-gas collection are reported in Section 2.12.4.3.

House-in-house system

In the house-in-house system, the equipment is in a closed building and additionally accommodated in a largely sealed enclosure which is vented to a filter system. Pouring and transfer operations occur within this enclosure, which is equipped with a trolley crane (charging trolley) for this purpose. The crane and equipment movements are remote-controlled. A computerised system is used to operate the fans automatically when process stages that produce fumes are in operation.

The off-gas volume to be extracted and cleaned is lower in comparison to regular building ventilation systems, and thus energy requirements are considerably lower.

Achieved environmental benefits

- Prevention and reduction of dust and metals emissions.
- Recovery of dust.
- The house-in-house technique avoids the need to install a building ventilation system.

Environmental performance and operational data

Table 5.31 shows dust performance data for the Metallo-Chimique plant in Belgium.

Table 5.31: Dust emissions from the diffuse emissions abatement plant at Metallo-Chimique

Installation	Gas treatment	Emissions
Hooding	Bag filter	Dust < 5 mg/Nm ³
<i>Source: [397, ILA 2012]</i>		

At the Aurubis plant in Hamburg, an enclosed electric smelting furnace is used with an enclosed lift charging system. The furnace feed is a wide range of copper/lead-containing materials. The top of the furnace is placed under an enclosure. Capture hoods are installed for tapping areas. Secondary gases from the electric furnace are collected and dedusted in a bag filter.

The casting moulds for crude lead matte (lead bullion) are housed inside a closed building and additionally accommodated in a largely sealed enclosure (house-in-house containment system), which is vented to a bag filter with lime injection. Casting operations mainly occur within this enclosure, which is equipped with a trolley crane (charging trolley) for this purpose, or in areas which are ventilated (e.g. tornado hoods). The crane and casting moulds' movements are remote-controlled.

Table 5.32 shows an example of the emission levels after the collection of fumes from the lead bullion casting machine in the house-in-house system and treatment in a bag filter with lime injection. Data are from continuous measurements and represent long-term normal operation under different conditions, such as variability of input materials, various loads and operating regimes, abrasion of equipment, and wear of filter elements.

Table 5.32: Dust and SO₂ emissions after the house-in-house system and a bag filter with lime injection

Origin	Technique	Pollutant	Values under normal operating conditions (mg/Nm ³)		Monitoring frequency
			Min.	Max.	
Lead bullion casting machine	Hoods and house-in-house	Dust	< 0.5	10	Continuous (half-hourly average)
		Dust	0.8	2.7	Continuous (daily average)
		Dust	2	4	Continuous (yearly average)
	Bag filter and lime injection (maximum flow rate 250 000 Nm ³ /h)	SO ₂	< 50	1425	Continuous (half-hourly average)
		SO ₂	65	250	Continuous (daily average)
		SO ₂	100	200	Continuous (yearly average)
		Cu	< 0.01	0.23	4 times per year (3*30 min)
		Pb	0.01	0.3	
		Ni		< 0.02	
		As	< 0.01	0.07	
		Cd	< 0.01	0.02	

Source: [378, Industrial NGOs 2012]

Table 5.33 gives the emission levels achieved after the treatment of secondary gas from the electric furnace. The variations of dust and SO₂ concentrations are due to the batch-wise operation of tapping slag and metal. Data are from continuous measurements and represent long-term normal operation under different conditions, such as variability of input materials, various loads and operating regimes, abrasion of equipment and wear of filter elements.

Table 5.33: Secondary emissions from an electric furnace with a bag filter

Plant	Origin	Technique	Pollutant	Values (mg/Nm ³)		Monitoring frequency
				Min.	Max.	
18	Secondary gas from electric furnace	Bag filter	Dust	< 0.5	5.5	Continuous (half-hourly average)
			Dust	< 0.5	4.2	Continuous (daily average)
			SO ₂	< 50	840	Continuous (half-hourly average)
			SO ₂	< 50	800	Continuous (daily average)
			Cu	< 0.01	0.2	Discontinuous measurements, 4 times per year (3*30 min)
			Pb	< 0.01	0.2	
			Ni	< 0.01	0.1	
			As	< 0.01	0.02	
Cd	< 0.02	< 0.02				
Source: [378, Industrial NGOs 2012]						

Table 5.34 gives the emissions of three other plants.

Table 5.34: Dust and metals emissions from Plants 6, 15 and 19

Plant	Technique	Pollutant	Values (mg/Nm ³)			Monitoring frequency
			Min.	Avg.	Max.	
6	Furnace suction (outside) / bag filter	Dust	< 1	< 1	6	Continuous measurement (Daily average)
		Pb	NR	< 1	2	
		Hg+Tl	< 0.002	< 0.002	< 0.002	
		Pb+Ni+Se	< 0.05	< 0.05	0.06	
		Sb+Cu+Sn	NR	0.05	0.08	
15	Bag filter, secondary gases	Dust	0.03	NR	0.33	Based on 11 (dust) and 2 (metals) samples of 3–5 hours
		Cu	< 0.002	NR	0.002	
		Pb	< 0.001	NR	0.002	
		Sb	NR	NR	0.1	
		As	NR	NR	0.002	
		Cd	NR	NR	0.001	
19	Bag filter	Dust	0.2	0.5	1	Discontinuous measurements (Half-hourly average)
		Pb+Cr+Cu+Mn+V	0.002	0.1	0.1	
NB: NR = Not reported. Source: [378, Industrial NGOs 2012]						

Cross-media effects

Hoods

No information provided.

Enclosed equipment with flue-gas extraction

Increase in energy use. The off-gas volume to be extracted and cleaned in the regular building ventilation in comparison with house-in-house is higher and thus requires more energy.

House-in-house system

No information provided.

Bag filter

Increase in energy use.

Technical considerations relevant to applicability

Hoods and enclosed equipment with flue-gas extraction

Generally applicable.

House-in-house system

Due to the space requirements and the connection with the other equipment, the house-in-house technique is suitable for reducing emissions from the tapping and charging of furnaces and casting in new installations or in the major upgrade of an existing installation.

Bag filter

Generally applicable.

Economics

The main operational cost for handling the gases is due to the electrical consumption of the fan. A fabric filter system requires 1.5 KWh per 1000 m³ of exhaust volume. Electric energy for a typical secondary smelter of 300 000 m³/h (from which the main process gases are below 10 %) costs approximately EUR 400 000 per year (EUR 0.10 per KWh).

Other operational costs for bag filters include:

- substitution of used fabric filter: up to twice a year;
- standard maintenance for other devices at a cost of between 5 % and 10 % of investment costs per year;
- cost of the treatment.

An increase in investment costs can also occur due to:

- keeping buildings enclosed;
- adapting the ventilation systems of the buildings;
- filtering the air before its release to the atmosphere.

Aurubis reports that the capital expenditure for installing the house-in-house system was EUR 6 million [397, ILA 2012].

Driving force for implementation

Environmental and health regulation requirements.

Example plants

BSB Recycling (DE), Muldenhütten Recycling und Umwelttechnik (DE), Metallo-Chimique (BE), Umicore (BE), Aurubis (DE), Elmet (ES), Weser-Metall (DE), and BMG Metall und Recycling GmbH (AT).

Reference literature

[397, ILA 2012]

5.3.4.2 Techniques to reduce channelled emissions of dusty air from the secondary smelter off-gas

Description

The techniques to consider are:

- cyclone (see Section 2.12.5.1.3);
- bag filter (see Section 2.12.5.1.4);
- wet scrubber (radial or jet) (see Section 2.12.5.1.6);
- wet ESP (see Section 2.12.5.1.2);
- mercury removal system (see Section 2.12.5.5).

These techniques can be used either individually or in combination.

Technical description

To reduce dust emissions from secondary smelter off-gas, the following techniques are used.

- Cyclones can be used as a precleaning device, always in conjunction with bag filters, see Section 2.12.5.1.3.
- Bag filters are highly efficient at controlling fine particles and are a commonly used filtration system. The addition of additives can be used to capture contaminated gases. Generally, all captured filter dusts are recycled (after leaching out undesired components, if required), see Section 2.12.5.1.4.
- Mercury removal systems using absorbents or other techniques are described in Section 2.12.5.5 and can be employed depending on the composition of the input materials.

For gases with a high water content (e.g. from material drying or slag granulation) or with pyrophoric dust, the following techniques are used.

- Wet scrubber (radial or jet). These can also be used in combination with an appropriate washing solution (e.g. alkaline solution) to clean flue-gases from which gaseous contamination has to be removed, see Section 2.12.5.2.2.
- Wet ESPs allow removal of very fine dust particles with a lower energy demand but high investment costs, see Section 2.12.5.1.2.
- Dust recovered from wet systems is removed as slimes either in a separate water circuit or with the effluent water treatment of the plant.

Achieved environmental benefits

- Reduction of dust and metals emissions.
- Recovery of raw materials.

Environmental performance and operational data

Below are some examples of a combination of the techniques listed above.

At Metallo-Chimique Beerse and Elmet Berango, the smelter can be used for smelting (in campaigns) secondary lead-tin materials. Metallo-Chimique uses a TBRC furnace for the smelting of secondary lead and tin materials. The furnace gases pass through an air-to-air cooler, cyclone and a bag filter before being emitted.

Table 5.35 shows dust emissions from three different furnaces producing secondary lead.

Table 5.35: Example of dust emissions from secondary smelters

Furnace type	Capacity	Gas pretreatment	Gas treatment	Emissions
Blast furnace	50 000 t/yr	NR	NR	< 2 mg/Nm ³ Gas flow 90 000 m ³ /h
TBRC (small)	30 t/charge	Cooler + cyclone	Bag filter	Dust < 5 mg/Nm ³
Smelter	60 t/charge	Cooler + cyclone	Bag filter + bag filter with Sorbalit injection	Dust < 5 mg/Nm ³

NB: NR = Not reported.
Source: [378, Industrial NGOs 2012], [397, ILA 2012]

The Umicore plant in Hoboken operates a batch process in an ISASMELT smelter for complex Pb-, Cu- and Ni-bearing secondary, and some primary, raw materials, resulting in an impure granulate copper and a rich lead oxide slag. Heat from the process gases is recovered as steam. After further cooling, the process gases are dedusted by a dry ESP and quenched before they are sent to the sulphuric acid plant. Secondary gases are extracted at the feed port, lance port, tapholes and refining furnace with dedicated hoods. They are cleaned in a bag filter with a capacity of 230 000 Nm³/h, and the gases are released to the atmosphere with < 1 mg/Nm³ of dust and < 300 mg/Nm³ of SO₂.

The lead oxide slag is crushed and fed into a blast furnace, together with other lead-bearing secondary materials, cokes and limestone, resulting in impure lead, a matte and poor slags. The process gases are first partially afterburnt in order to oxidise the pyrophoric metal particles, cooled with energy recovery, dedusted in a bag filter and finally afterburnt for CO. The heat is used to heat the injected air in the blast furnace. Then the process gases are cooled further in a heat exchanger and by mixing them with the secondary gases in order to condensate volatile metals (As, Hg) and filtered in a second bag filter before being released to the atmosphere. Table 5.36 shows the performance achieved.

Table 5.36: Example of dust emissions from the ISASMELT smelter and blast furnace for secondary lead and tin production at Umicore Hoboken

Furnace type	Capacity	Gas pretreatment	Gas treatment	Emission
ISASMELT	1000 t/d	Energy recovery, dry ESP, quenching	Sulphuric acid plant (double contact/double absorption)	Dust < 1 mg/Nm ³
Blast furnace	1000 t/d	Partial afterburning, cooling, bag filter	CO afterburning, cooling mixing with secondary gases, bag filter	Dust < 1 mg/Nm ³

Source: [397, ILA 2012]

KGHM operates primary copper smelting in Legnica, Głogów 1 and Głogów 2 smelters. The flue-dust from copper smelting, captured in bag filters and in wet dedusting systems, is processed into crude lead in four rotary rocking furnaces located in Głogów 1.

The lead smelting is a batch process. Once a batch of the lead blend and the required volume of iron scrap have been charged into the furnace, a production cycle begins. In the first stage of the process, the material is heated and subsequently dried. Hydrocarbons evaporate and organic carbon burns down. The most important chemical reactions – reduction of lead compounds – take place when the batch material, already in the form of a melt, has reached a temperature of about 1000 °C. At a temperature of 1050–1100 °C, the melt is tapped from the furnace into

ladles for natural segregation of metal from slag. The length of a production cycle in the furnace is around four hours.

Each furnace has an individual off-gas post-combusting and cooling installation. The gases from these installations go to the central dedusting installation, consisting of a mixing chamber and a filtration system. After dust removal, the gases go to a desulphurisation plant for further treatment. Here the gases from the rotary rocking furnaces (65 000 m³/h) are treated together with the flue-gases from a power plant (1 000 000 m³/h). In 2014 (during the finalisation of the NFM BREF review) changes were being undertaken in order to send the flue-gases from rotary rocking furnaces to a dedicated abatement system, made up of a bag filter, to reduce dust and metal emissions, and a wet scrubber to reduce the SO₂ emission.

At the Aurubis plant in Hamburg, the electric furnace process off-gas is cooled with recirculated cold gas and an air-to-gas cooler. Cooled gases are transferred to a bag filter, and further passed through a mercury removal step and subsequently an acid plant. Secondary gases from the electric furnace are collected and dedusted in a bag filter.

More data are reported in the following table.

Table 5.37: Dust and metals emissions from secondary lead production furnaces

Plant	Technique	Pollutant	Values (mg/Nm ³)			Monitoring frequency
			Min.	Avg.	Max.	
1	Closed system, lime injection, bag filter	Dust	0.2	< 0.5	2	Twice a year
		Pb	0.1	0.2	0.6	
3.1	Not known	Dust	0.0	0.061	6.829	Continuous (half-hourly average)
		Pb	0.295	0.311	0.328	Twice a year
		Cu	0.0107	0.0212	0.0317	
		Ni	0.009	0.0237	0.0384	
		Zn	0.0256	0.231	0.438	
		As	0.002	0.0074	0.0128	
		Cd	0.0003	0.0017	0.128	
Hg	0.0003	0.0015	0.003			
3.2	Not known	Dust	0.014	0.72	6.627	Continuous (half-hourly average)
		Pb	1.707	3.653	5.6	Twice a year
		Cu	0.0192	0.0233	0.0275	
		Ni	0.0208	0.022	0.0232	
		Zn	0.0605	0.0727	0.085	
		As	0.004	0.0068	0.0095	
		Cd	0.0098	0.006	0.0021	
		Hg	0.0003	0.0007	0.001	
		Tl	0.0	0.0019	0.0038	
		Se	0.0015	0.0018	0.002	
		Sb	0.0607	0.0683	0.076	
Sn	0.0001	0.0115	0.0228			
4	Lime injection and bag filter	Dust	0.2	0.8	3	Continuous (monthly average)
		Pb	0.1	0.3	1	
5	Post-combustion chamber, high-temperature bag filter, liquid media, flue-gas desulphurisation	Dust	0.140	0.460	1.24	4 times per year
		Pb	0.010	0.030	0.059	
		Cu+Pb+Zn +Ni and compounds	0.011	0.035	0.062	
		Sb+Sn+Te and compounds	0.003	0.01	0.01	
		Cd+As+Hg +Tl+Se and compounds	0.01	0.02	0.05	
6	Bag filter	Dust	NR	< 1	5	Continuous (daily average)
		Pb	NR	< 1	2	
		Hg+Tl	NR	< 0.01	< 0.01	Once a year
		Pb+Ni+Se	NR	0.3	0.4	Once every 3 years
		Sb+Cu+Sn	NR	< 0.1	0.2	
7	Bag filter	Dust	< 0.5	< 0.5	1	Continuous (daily average)
		Pb	< 0.05	0.06	0.16	11 times per year
		As+Cd	< 0.005	< 0.005	0.007	
	Bag filter	Dust	< 0.5	< 0.5	0.5	Continuous (daily average)

		Pb	< 0.05	< 0.05	< 0.05	9 times per year
		As+Cd	< 0.005	0.005	0.018	7 times per year
9	Lime injection in afterburning chamber and bag filter	Dust	0.2	0.7	2	Continuous (daily average)
		Pb	0.1	0.2	0.7	Once every 3 years
11	Bag filter	Dust	0.1	0.8	5	3 times per year
		Pb	0.06	0.5	3	
12.1	Bag filter	Dust	1.7	2.5	3.9	Continuous (half-hourly average)
		Zn	0.14	0.219	0.304	Once a year (Measurements taken in different years were used to calculate minimum, maximum and average)
		Pb	0.029	0.034	0.05	
		Cu	0.16	0.286	0.444	
		Cr	0	0.015	0.029	
		Mn	0.005	0.006	0.008	
		Sn	0.01	0.015	0.024	
Hg	0	0.0016	0.004			
12.2	Bag filter	Dust	NR	1.5	14.6	Continuous (half-hourly average)
		Zn	0.139	0.17	0.204	Once a year (Measurements taken in different years were used to calculate minimum, maximum and average)
		Pb	0.036	0.047	0.064	
		Cu	0.147	0.18	0.204	
		Cr	0.0002	0.006	0.01	
		Sn	0.001	0.015	0.026	
		As	0	0.006	0.017	
		Cd	0.007	0.009	0.011	
Hg	0	0.002	0.004			
13.1	Bag filter, adsorption filter with Sorbalit injection	Dust	< 0.5	< 0.5	< 0.5	Twice a year
		Sb	< 0.0005	0.0011	0.0016	
		Cu	0.0018	0.0046	0.0073	
		Cd	< 0.0005	0.0008	0.0011	
		Pb	0.0015	0.0160	0.0305	
		Sn	< 0.001	0.002	0.003	
		Zn	0.0055	0.0352	0.0649	
13.2 (TBRC)	Bag filter	Dust	< 0.5	< 0.5	< 0.5	Twice a year
		Cu	0.0011	0.0067	0.0116	
		Pb	0.0022	0.0063	0.0104	
		Sn	< 0.001	0.003	0.004	
		Zn	0.0066	0.0136	0.0206	
13.3 (TBRC)	Bag filter	Dust	< 0.5	< 0.5	< 0.5	Twice a year
		Cu	< 0.0005	0.0007	0.0008	
		Pb	0.0023	0.0082	0.0141	
		Sn	< 0.001	0.002	0.003	
		Zn	0.0018	0.0044	0.0070	
15.1	Afterburner, bag filter, heat recovery, mixing with secondary gases, 2nd bag	Dust	0.07	0.27	0.91	11 times per year
		Pb	0.03	0.08	0.15	
		Cu	< 0.001	0.001	0.001	
		Cd	0.0004	0.003	0.01	
		As	0.004	0.09	0.24	

	filter	Zn	0.01	0.02	0.03	
		Sb	0.0003	0.01	0.04	
		Sn	0.002	0.006	0.03	
		Hg	< 0.001	0.019	0.08	
15.2	Scrubber	Dust	0.42	2.17	6.01	13 times per year
		Pb	0.01	0.17	1.19	
		Cu	0.0004	0.01	0.05	
		Cd	0.002	0.006	0.01	
		As	0.001	0.02	0.09	
		Sb	0.14	0.92	2.18	
		Zn	0.0	0.03	0.2	
15.3 (ISASM ELT)	Bag filter	Dust	0.03	0.12	0.33	11 times per year
		Pb	< 0.001	NR	0.004	Twice a year
		Cu	< 0.002	NR	0.002	
		Cd	< 0.000 2	NR	0.0009	
19	Not reported	Dust	0.4	3	7	Continuous measurement (daily average)
		Sb+Cr+Cu +Mn+V+ Zn+Sn+ Fluoride+ Cyanide	0.05	< 0.1	0.1	3 times a year
		Pb+Co+Ni +Se+Te	< 0.05	< 0.05	0.01	
		Hg	0.0012	0.032	0.05	
		As+Cd+ Cr(VI)	0.001	0.001	0.002	
NB: NR = Not reported. Source: [378, Industrial NGOs 2012], [385, Germany 2012], [393, Austria 2012]						

Cross-media effects

Cyclone

Increase in energy use.

Bag filter and ESP

- Increase in energy use.
- Waste may be produced if the collected dust cannot be returned to the process. To recover the flue-dusts, treatment is required, internally or externally, to remove impurities.

Wet scrubber and wet ESP

- Increase in energy use.
- Waste water is produced that should be treated to prevent the discharge of metals and other substances to water. To recover the flue-dusts, treatment is required, internally or externally, to remove impurities.

Mercury removal

- Increase in energy use.
- Use of additives.
- Solid or liquid waste is produced that has to be treated internally or externally.
- Waste containing mercury has to be landfilled.

Technical consideration relevant to applicability*Cyclone*

Generally applicable. Cyclones are not sufficient to reduce dust emissions as a stand-alone technique. They have to be used in combination with another filtration system such as a bag filter.

Bag filter

Generally applicable.

Wet scrubber and wet ESP

These techniques are used only for gases with a high water content or for pyrophoric dust.

Mercury removal plant

The use of these techniques depends on the composition of the input materials.

Economics

Investment costs for the installation of the mercury removal plant are reported by Aurubis Hamburg to be up to EUR 5 million (condenser, heaters, bag filter, injection system, absorber and fans) [397, ILA 2012]

Driving force for implementation

- Environmental regulation requirements.
- Recovery of raw material.

Example plants

Muldenhütten Recycling und Umwelttechnik (DE), Aurubis (DE), HJ Enthoven & Sons (UK), Umicore (BE), KGHM (PL), Boliden Bergsöe (SE), Metallo-Chimique (BE), and Elmet (ES).

Reference literature

[397, ILA 2012]

5.3.4.3 Techniques to reduce SO₂ emissions from the furnaces of secondary smelters

Description

Techniques to reduce SO₂ emissions from the furnaces of secondary smelters are:

- desulphurisation of the input materials;
- fixation of sulphur in the smelt phase using additives;
- treatment of the SO₂-containing gas stream by lime or sodium bicarbonate injection;
- alkaline scrubber after dust filtration;
- sulphuric acid production (see Sections 2.12.5.4.1 and 2.12.5.4.2).

Technical description

Desulphurisation of the input materials

Desulphurisation of the input materials is covered in Section 5.3.2.5. This is carried out before the smelting.

Fixation of sulphur

SO₂ emissions from secondary smelters can be reduced by the addition of iron and/or soda. Iron added to the furnace reacts with sulphur contained in the feed material to form a matte (for example, iron sulphide), thus capturing the sulphur and preventing SO₂ emissions. The capture rate by producing matte is approximately 90 % under optimal conditions. The matte leaves the furnace as a liquid, but is solid at room temperature, making it dust-free and easier to handle.

Copper, if present in the feed material, will act in the same way as iron, leading to the fixation of sulphur as copper sulphide.

The matte comprises mainly iron, sulphur and Na₂S, and a minor percentage of lead, and can be sold as a reductant or for the recovery of these elements, or landfilled. The composition of the charge thus has to be balanced to achieve a slag composition which is acceptable for future sale, recycling or landfill (if needed after pretreatment - with the lowest possible metal loss).

Lime or sodium bicarbonate injection

SO₂ removal is achieved by the dry injection of lime or sodium bicarbonate in the afterburner outlet at 1100 °C, or, at a lower temperature, in the gas duct before the bag filter. Higher yields are possible by simultaneous water injection, by increased lime injection, or by using lime with a high specific surface.

When using existing gas-cleaning equipment with a fabric filter that is designed to remove process dust, lime injection can be installed in order to remove SO₂, if the filter capacity allows this. Lime injection is possible when the temperature, moisture content and contact time are sufficient, though a mixing chamber might be necessary in order to obtain a good mix of the process gas, the injected water and the lime. An existing filter installation might not be sufficient, since the amount of dust greatly increases, and thus the filter installation might need to be replaced.

Alkaline scrubbing

The gas stream from the furnace is initially quenched with water to 200 °C. It then passes through a bag filter and goes to a wet scrubber with a washing solution (e.g. lime, NaOH or H₂O₂) to capture the SO₂. Sulphite is oxidised to sulphate, and this is followed by the recovery of gypsum after filtration in the case of lime, or sodium sulphate after the evaporation of water in the case of sodium hydroxide. Water-saturated gases are chilled to remove moisture. At least a 99 % SO₂ removal efficiency can be achieved under optimal conditions.

Sulphuric acid plant (see Sections 2.12.5.4.1 and 2.12.5.4.2)

A combination of some of the techniques can be used, with the techniques selected depending on the composition of the raw material and the furnace type used for smelting.

These techniques can also be appropriate for the abatement of SO₂ emissions from smelters processing flue-dust from primary copper production.

Achieved environmental benefits

Reduction in SO₂ emissions. The SO₂ can be recovered in the form of sulphuric acid produced at the sulphuric acid plants. Gypsum produced from alkaline scrubbing could be reused.

Environmental performance and operational data

The efficiency of the treatment techniques described will depend on the gas composition (moisture and SO₂ concentration), the furnace used, the fluctuation of the gas composition as a function of time, and the temperature.

Fixation of sulphur

The capture rate by producing matte is approximately 90 % under optimal conditions.

Lime or sodium bicarbonate injection

Lime injection will result in dust and SO₂ removal being achieved with the same fabric filter. There is also a positive effect on dioxin emissions. The resulting solids mixture of lime and gypsum can be reused in other metallurgical or water treatment processes.

As the reaction of SO₂ with lime takes place at the surface of the lime particles, and as the reaction proceeds faster at a higher moisture content, lime consumption can be reduced by:

- the simultaneous injection of water (steam);
- using high surface/porosity hydrated lime;
- and/or by recirculation of the fabric filter dust.

This process will result in an overall sulphur capture in excess of 95 % under optimum conditions.

Figures stated here are related to lime, sodium or alkaline water injection in the flue-gas from a typical production of 30 000–50 000 tonnes of lead per year for a typical secondary blast furnace plant (e.g. Boliden Bergsöe, Sweden; Johnson Controls Recycling, Germany; Kovohute Pribram, Czech Republic; Campine, Belgium).

- Process gas flow: 50 000–90 000 Nm³/h.
- SO₂ emission: < 500 mg/Nm³^(*) (yearly average).
- Dust emission: < 2 mg/Nm³.

^(*) Tail gas cleaning with dry lime injection or alkali water injection to afterburner.

At Beerse, Belgium, an existing continuous process with varying SO₂ concentrations is in place. Dry lime is injected at two points in the process that have high and low temperatures respectively. Clogging and blocking of the tubes restricts the usable lime injection rate. The mixture of lead sulphate and dust is recycled internally, but gypsum cannot be recycled internally and the disposal costs for gypsum/dust are high.

At Bergsöe, Sweden, an existing continuous lead smelting process is in place with varying SO₂ concentrations using lime injection in the afterburner of a lead smelter. The main process is designed to capture SO₂ through the addition of iron to the furnace and the formation of an iron matte. The capture rate by producing matte is approximately 90 %. Further SO₂ removal is achieved by the dry injection of lime (~ 60 kg/h) at the afterburner outlet at 1100 °C.

Water injection is not possible because of clogging and blocking in pipes and possible condensation problems in the bag filters. Higher yields would be possible at a higher lime injection rate, but lime causes clogging and blocking of the tubes at high injection rates. Due to

the lead content of the filter dust, it is recycled to the furnace after dechlorination and the lime content aids slag formation. The cost for the treatment of filter dust is relatively low.

The performance data for the example plants are shown in Table 5.38.

Table 5.38: Performance data for example plants

Plant	SO ₂ (mg/Nm ³)		Dust (mg/Nm ³)		Comment
	Inlet	Outlet	Inlet	Outlet	
Metallo-Chimique Beerse (Whole battery smelter)	1000	400	NR	NR	Two-point injection
Boliden Bergsöe (Lead smelter)	1000	400	NR	< 1	Sulphur removed as iron matte with 650 kg/h lime addition to afterburner. Dust is used in process
NR = Not reported. Source: [346, SO ₂ - Lime injection FINAL 4.2.2010]					

Sulphuric acid plant

An example of an ISASMELT smelter with a 1000 t/d capacity (batch process) is the Umicore plant in Belgium:

- input materials: materials containing lead and copper;
- outputs: impure copper and lead oxide slag;
- process gas flow: 54 000 Nm³/h;
- SO₂ concentration in the process gases: up to 10 %;
- SO₂ concentration after the double contact/double absorption sulphuric acid plant: < 300 mg/Nm³ (daily average).

At Aurubis Hamburg, lead- and copper-containing secondary materials, slag, matte dusts, as well as primary lead concentrates are processed in an electric furnace. The electric furnace process off-gas is cooled with recirculated cold gas and by an air-to-gas cooler. The off-gas is then filtered in a bag filter and sent through a mercury absorption unit with a selenium-containing absorber. Process off-gas is then transferred to a double contact/double absorption acid plant when it contains significant SO₂, or to the stack solely for the reduction of gas with a low SO₂ content. Continuous measurements are performed for SO₂, and levels of 330–1980 mg/Nm³ are reported as half-hourly average values. Secondary gases (furnace roof enclosure, hoods at tapholes) from the electric furnace are collected and dedusted in a bag filter. Continuous measurements are performed for dust and SO₂, levels of 0.5–5.5 mg/Nm³ and 50–840 mg/Nm³ respectively are reported as half-hourly average values.

Table 5.39 shows the performance of the secondary lead and tin production plants in the EU-28 that apply a combination of the techniques listed above.

Table 5.39: SO₂ emissions from secondary lead and tin plants in the EU-28

Plant	Technique	SO ₂ emissions (mg/Nm ³)			Monitoring frequency
		Min.	Avg.	Max.	
1	Capture of sulphur in matte approx. 90 %, closed system. Lime injection in gas stream for total capture of SO ₂ in excess of 95 %.	200	360	800	Continuous measurement. (yearly average) (Minimum and maximum are related to the daily average)
4	Lime injection with bag filter	350	480	1000	Continuous measurement (hourly average)
5	Post-combustion chamber, high-temperature bag filtration, liquid media, flue-gas desulphurisation	1	102	202	Twice a year (4-hour average)
7	Desulphurised paste and fluxes (soda) are added to the furnace	< 10	109	375	Continuous measurements (average based on batch duration)
9	Capture of up to 90 % of sulphur in the furnace feed through addition of iron to form a matte phase (iron sulphite); SO ₂ adsorption from off-gas by lime injection in afterburning chamber	200	370	500	Continuous measurement (daily average)
11	Iron in charge, alkaline water injection in afterburner	279	402	800	4 times per year
13	Bag filter with an adsorption filter with Sorbalit injection	0	80	500	Continuous measurement (hourly average)
15	Sulphur collection in solid phase > 97 %, afterburner, bag filter, heat recovery, mixing with secondary gases, 2nd bag filter	50	83	154	11 times per year (1–2 hour sample)
18	Sulphuric acid plant	330		1080	Continuous measurement (daily average)

Source: [385, Germany 2012], [378, Industrial NGOs 2012]

Cross-media effects

Desulphurisation of the input raw materials

See Section 5.3.2.5.

Fixation of sulphur in the smelt phase using additives

- Use of additives.
- Increase of slag and of lead lost in the slag.

Treatment of the SO₂-containing gas stream by lime or sodium bicarbonate injection

- Increase in energy use. The use of a mixing chamber creates an additional pressure drop, resulting in higher energy use by the fan.
- Use of additives.
- Waste may be produced if the collected dust cannot be reused.

Alkaline scrubber after dust filtration

- Increase in energy use.
- Waste water is produced that should be treated to prevent the discharge of metals and other substances to water.

Sulphuric acid plant

See Sections 2.12.5.4.1 and 2.12.5.4.2.

Technical considerations relevant to applicability

Local market conditions and the required quality specifications for the generated by-products can help determine which technique is applied.

Desulphurisation of the input raw materials

See Section 5.3.2.5.

Fixation of sulphur in the smelt phase using additives

SO₂ capture by the addition of iron or alkaline fluxes is applicable if there is a destination for the iron matte or slag produced.

Treatment of the SO₂-containing gas stream by lime or sodium bicarbonate injection

SO₂ capture in the waste gas stream by adding additives in the dry state is applicable for treating off-gases from secondary smelters using sulphur-containing materials, under appropriate process conditions (i.e. SO₂ content, variability of SO₂ content, temperature, moisture content, additives).

Alkaline scrubber after dust filtration

Wet scrubbing techniques can only be applied when there are appropriate solutions for the water stream (waste water treatment or evaporation) and the obtained sulphate products (commercialised, recycled or dumped). The applicability of the wet scrubber may be also limited in arid areas by the large volume of water necessary.

Sulphuric acid plant

Recovery of SO₂ in a double contact/double absorption acid plant is predominantly applied for furnaces processing sulphur-containing materials, or a combination of primary and secondary materials, or if there are primary and secondary smelters at a site.

Economics

Costs need to be determined and compared for the operational performance of each technique, as process conditions can vary from smelter to smelter.

Desulphurisation of the input raw materials

If desulphurisation occurs prior to smelting, a lower amount of additives and energy are required for slag formation. As such, the cost of desulphurisation of the feed material should be

compared with the advantage of using fewer fluxes and agents, a shorter smelting time, lower energy consumption, and less slag being produced for disposal.

Fixation of sulphur in the smelt phase using additives

The fixation of sulphur by additives such as iron or soda results in an increase in operational costs, due to the cost of the additives and manipulation of the products. However, the slag produced is often less leachable, and therefore easier to both use and dispose of.

Treatment of the SO₂-containing gas stream by lime or sodium bicarbonate injection

There is a low investment cost associated with the installation of a dry SO₂ capture system (injection of lime or sodium bicarbonate) at existing plants, providing that the capacity of the installed dust collection system is sufficient to handle the extra amount of dust. The cost of an additional bag filter, if necessary, would be considerable. The quantities of lime that are needed can be reduced by using a lime with a high specific surface and/or by recirculation of the fabric filter dust. The injection of sodium bicarbonate may be used as well, although the cost would be drastically higher.

Investment costs for the plant in Beerse are reported as EUR 550 000 (mixing chamber: EUR 100 000, additional cost for fabric filter: EUR 190 000, injection system including silo: EUR 60 000).

Alkaline scrubber after dust filtration

Scrubbers require considerable investment, and installation can sometimes require adaptations to the existing waste water treatment plants.

For all methods, the treatment of the obtained by-products or waste needs to be taken into account in the operational costs.

Driving force for implementation

Environmental regulation requirements.

Example plants

Boliden Bergsöe (SE), Johnson Controls Recycling (DE), Kovohute Pribram (CZ), Campine (BE), Muldenhütten Recycling und Umwelttechnik (DE), HJ Enthoven & Sons (UK), Aurubis (DE), Umicore (BE), KGHM (PL), and Metallo-Chimique (BE).

Reference literature

[346, Eurometaux 2010], [397, ILA 2012]

5.3.4.4 Use of afterburners to remove carbon monoxide and organic carbon including PCDD/F

Description

Afterburners require sufficient oxygen, a high temperature, turbulence and enough residence time to decompose and oxidise all the carbon in the flue-gas and to destroy dioxins.

Technical description

A combination of an afterburner and a cooling system can be used to remove organic carbon (including PCDD/F) and CO from furnace off-gases. A bag filter is used to reduce dust emissions.

The afterburner is a chamber where the flue-gas is mixed with excess oxygen under turbulence and at high temperatures (> 850 °C) and with enough residence time to decompose and burn all the carbon in the gas stream, and to destroy any dioxins. The gases are then quenched (below 250 °C) to avoid the reformation of dioxins, or, if applicable, cooled for heat recovery.

The example below (see Figure 5.5) is part of a lead-acid battery recovery system that uses the shaft furnace off-gases in the afterburner. The emission abatement system incorporates an afterburner to destroy organic carbon (including PCDD/F).

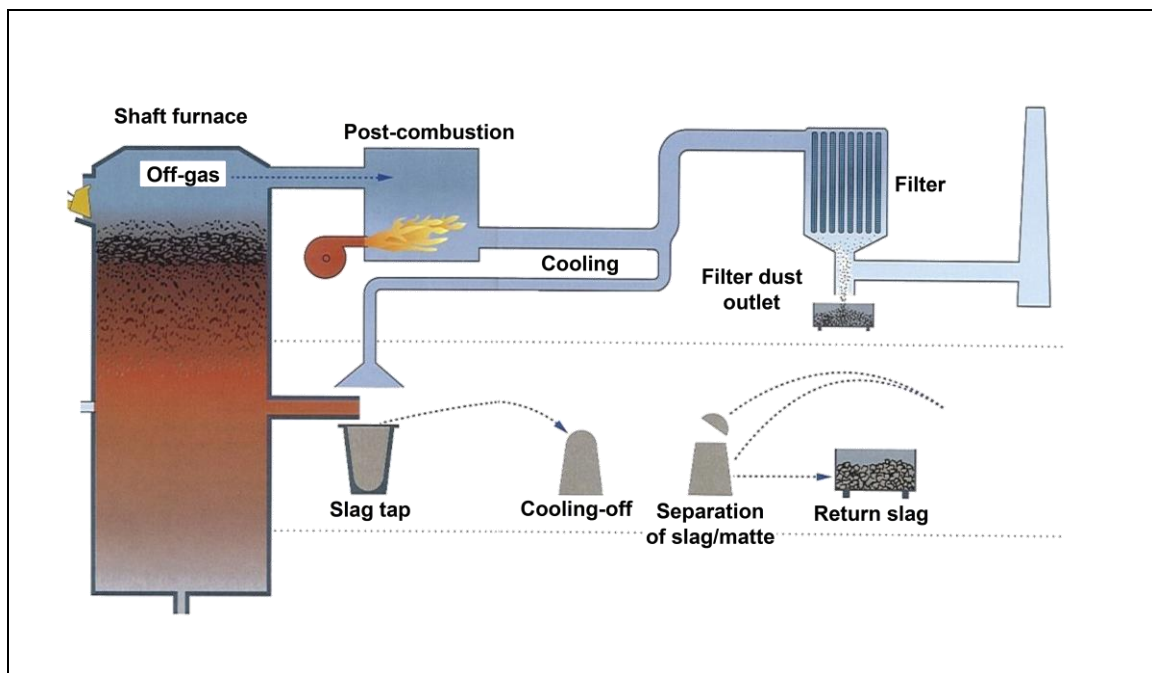

Figure 5.5: Afterburner system used with a whole battery smelter (VARTA process)

Achieved environmental benefits

- Reduction of CO and VOC (including PCDD/F) emissions.
- Recovery of energy, where feasible.
- Reduction of lime addition to form slag, when the lime-containing dust is recirculated to the furnace.

Environmental performance and operational data

If applicable, energy can be recovered for the internal heating of the site and/or external district heating; 30–40 GWh could be recovered from one shaft furnace plant.

KGHM produces crude lead from copper flue-dust in Głogów 1. The lead smelting batch process used occurs in four rotary rocking furnaces. In the first process stage, the material is heated and subsequently dried. Hydrocarbons evaporate and organic carbon burns down. Each furnace has an individual off-gas post-combusting and cooling installation. The gases from these installations go to a central dedusting installation, consisting of a mixing chamber and a bag filter. After dust removal, the gases are mixed with the gases from a power plant and go to a desulphurisation plant for further treatment.

At the blast furnace of Umicore Hoboken, afterburning of the process gases results in stack outputs of < 0.005 ng I-TEQ/Nm³ for PCDD/PCDF and < 50 mg/Nm³ for CO. The gases are first partially afterburnt, cooled and dedusted and then fully afterburnt with heat recovery.

Typical performance data for a shaft furnace with an afterburner are given in Table 5.40.

Table 5.40: Performance data for a shaft furnace with an afterburner

Parameter	Unit	Content
Process gas flow (at stack)	m ³ /h	50 000–90 000
CO	mg/Nm ³	< 500
PCDD/PCDF	ng I-TEQ/Nm ³	< 0.1
<i>Source: [397, ILA 2012]</i>		

For heat recovery, PCDD/PCDF levels may be high due to some reformation of these compounds but are typically below 0.3 ng I-TEQ/Nm³.

Table 5.41: Emissions from afterburners in secondary lead and tin production

Plant	Technique	Pollutant	Method	Unit	Values			Monitoring frequency
					Min.	Average	Max.	
1	Afterburner	VOCs		mg/Nm ³	NR	NR	NR	
		CO		mg/Nm ³	NR	NR	NR	
5	Post-combustion chamber	VOCs (as C)	EN13526	mg/Nm ³	31.2	32.4	33.5	- Twice a year (4-hours samples)
		CO		mg/Nm ³	NR	NR	NR	
11	Afterburner	TVOC	Nr	mg/Nm ³	5	8	33	Spot sample (4 times per year)
		CO		mg/Nm ³	7	47	315	Spot sample (4 times per year)
		NO ₂		mg/Nm ³	40	77	260	Spot sample (4 times per year)
15	Afterburner	TVOC	EN12619 EN13526	mg/Nm ³	3	15	27	Twice a year (1-hour sample)
		CO		mg/Nm ³	16	23	33	Spot sample (4 times per year)
NB: NR = Not reported. <i>Source: [378, Industrial NGOs 2012]</i>								

Cross-media effects

- Increase of NO_x emissions.
- Fuel is needed if the energy produced by the flue-gas oxidation is not sufficient to reach the required temperature.

Technical considerations relevant to applicability

Generally applicable. An afterburner is used in plants which do not separate plastic prior to smelting.

Economics

The following cost effects should be taken into account:

- increase in energy consumption;
- increase in investment cost.

Driving force for implementation

- Environmental regulation requirements.
- Heat recovery.

Example plants

Metallo-Chimique (BE), Boliden Bergsöe (SE), Johnson Controls Recycling (DE), Kovohute Příbram (CZ), Campine (BE), KGHM Głogów (PL), and Umicore (BE).

Reference literature

[254, VDI 2004], [397, ILA 2012]

5.3.4.5 Use of a regenerative thermal oxidiser (RTO) to remove organic carbon, including PCDD/F

Description

Regenerative thermal oxidisers (RTOs) use the heat energy of the flue-gas from the afterburner to heat flue-gas entering the combustion chamber.

Technical description

In this type of afterburner, the flue-gas is heated before entering the combustion chamber by passing through a ceramic bed that was heated before by the gas flow leaving the combustion chamber.

In the RTO, the gas flow follows these steps:

- firstly, the flue-gas stream enters the oxidiser through the common inlet and passes into a regenerative chamber through a butterfly valve;
- the flue-gas stream then passes through a ceramic heat exchanger matrix, which raises the gas temperature near to oxidation temperature;
- the stream then enters the combustion chamber, which is maintained at about 850 °C by burners;
- it then leaves the combustion chamber through a second ceramic heat exchanger matrix, transferring its thermal energy to be reused for preheating the next cycle;
- finally, the now clean gas stream is released through an outlet valve to discharge.

The released heat decreases the fuel consumption of the burners.

For dusty flue-gas, an efficient dedusting system is required before the gas enters the RTO, otherwise the dust could block the ceramic bed. VOCs, residual CO, PCDD/F and dust can be present in the furnace off-gas. These off-gases are dedusted by a fabric filter and then sent to a RTO (see Figure 5.6). After the bag filter, the VOC content is checked. If the VOC concentration rises, the off-gas can be sent to the RTO. This is a special option for an additional gas treatment step used only for high concentrations of VOCs (including PCDD/F), which may occur in some processes. Emissions are continuously monitored in the stack for dust, SO₂, VOCs and volume.

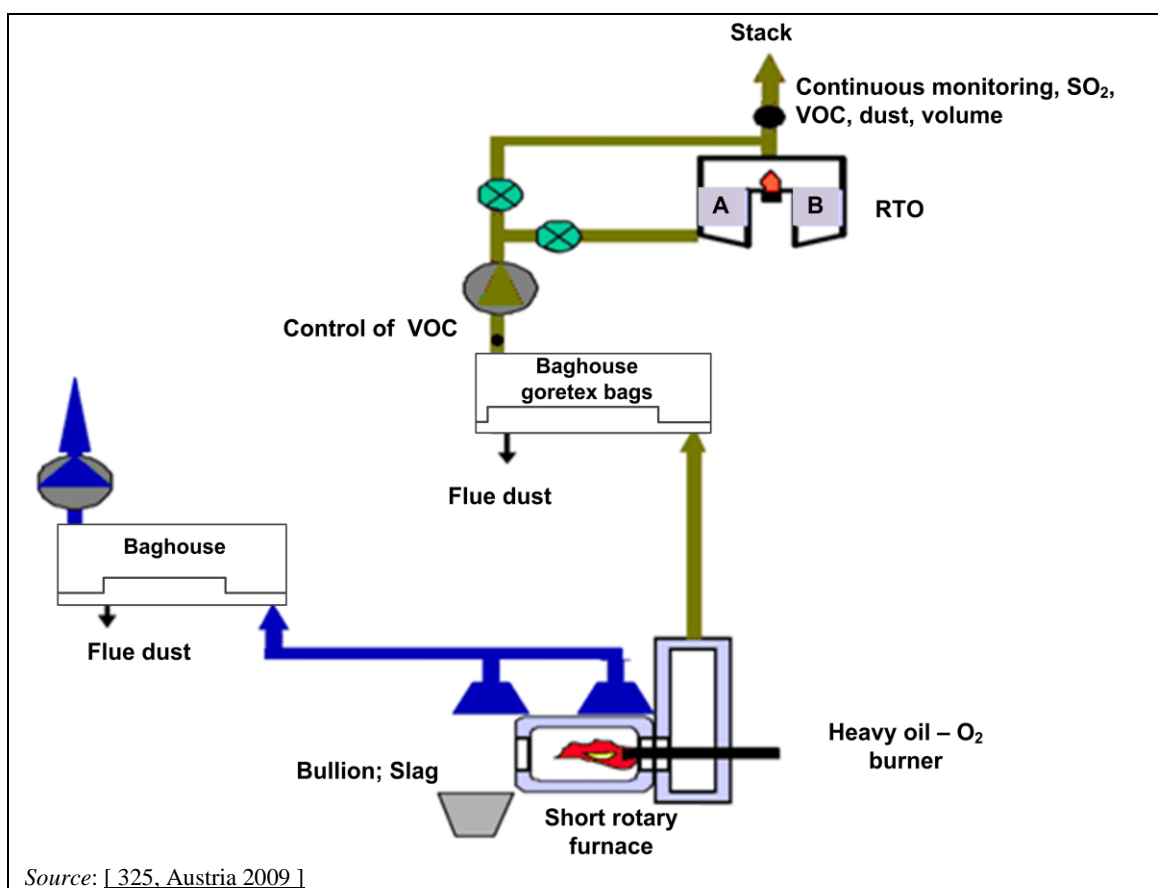

Figure 5.6: General plant layout with a RTO

Achieved environmental benefits

- Reduction of CO, VOC and PCDD/F emissions.
- Reduction of fuel consumption, due to the recovery of energy from the off-gases.

Environmental performance and operational data

To prevent emissions during the switching of the gas flow from one ceramic bed to another, a compensation chamber is needed. Alternatively, it is possible to run the RTO system with three ceramic beds.

Table 5.42 shows the achieved emission concentration values for some organic pollutants after the RTO.

Table 5.42: Total C and BaP emissions at the main stack

Emission point	Year	Total C (mg/Nm ³)	Benzo(a)pyrene (mg/Nm ³)
Stack	2000	15.8	0.0016
	2003	11.4	NA
	2007	7.9	0.00685
NB: Continuous measurements.			

The VOC emissions are between 15 mg/Nm³ and 40 mg/Nm³, with an average of 20 mg/Nm³ (daily average, continuous measurement), and PCDD/F emissions are 0.0231–0.0898 ng I-TEQ/Nm³ (spot sample, six-hour average [237, UBA (A) 2004], [372, BMG Metall und Recycling GmbH 2010]). Autothermal operation is achieved, and less gas is needed.

Cross-media effects

Increase in energy use if the heat generated by the oxidation of the flue-gas component is not enough to reach the required temperature.

Technical considerations relevant to applicability

Generally applicable.

Economics

Increase in investment costs.

Driving force for implementation

- Environmental regulation requirements.
- Lower energy demand compared to using an afterburner.

Example plants

BMG Metall und Recycling (AT).

Reference literature

[325, Austria 2009], [397, ILA 2012]

5.3.4.6 Techniques to prevent and reduce PCDD/F emissions to air

Description

The techniques to consider are listed below. These techniques can be applied either individually or in combination. For the description of these techniques, see Section 2.12.5.3.

- Reducing the organic and/or halogen (e.g. Cl, Br) content in the feed materials.
- Using optimum combustion conditions.
- Using charging systems that allow small additions of raw materials into semi-closed furnaces.
- Thermal destruction of dioxins in the furnace at high temperatures ($> 850\text{ }^{\circ}\text{C}$).
- Oxygen injection in the upper zone of a furnace.
- Avoiding exhaust systems with high dust build-up for temperatures of $> 250\text{ }^{\circ}\text{C}$.
- Applying a post-combustion chamber, afterburner (see Section 5.3.4.4) or RTO (see Section 5.3.4.5).
- Rapid quenching of the off-gases in a temperature range between $400\text{ }^{\circ}\text{C}$ and $200\text{ }^{\circ}\text{C}$.
- Injection of adsorption agent (e.g. activated carbon, lignite coke, lime) before dedusting.
- Use of an efficient dust collection system.

Technical description

For the technical description of these techniques, see Section 2.12.5.3.

Achieved environmental benefits

Reducing the organic and/or halogen (e.g. Cl, Br) content in the feed materials

- Reduction of PCDD/F gas emissions.
- Increase in the furnace productivity.

Using optimum combustion conditions, oxygen injection in the upper zone of a furnace, and applying a post-combustion chamber, afterburner or RTO

Reduction of PCDD/F, VOCs and CO gas emissions. If the waste heat from the afterburner is not used or usable, then the RTO needs less energy than the afterburner.

Using charging systems that allow small additions of raw materials into semi-closed furnaces

- Prevention of the reformation of PCDD/F.
- Optimisation of the process.

Thermal destruction of dioxins in the furnace at high temperatures ($> 850\text{ }^{\circ}\text{C}$), rapid quenching of off-gases between $400\text{ }^{\circ}\text{C}$ and $200\text{ }^{\circ}\text{C}$, and avoiding exhaust systems with high dust build-up for temperatures of $> 250\text{ }^{\circ}\text{C}$

Prevention of PCDD/F formation.

Injection of adsorption agent (e.g. activated carbon, lignite coke, lime) before dedusting

Reduction of PCDD/F, VOC and heavy metal emissions.

Use of an efficient dust collection system

Reduction of PCDD/F, dust and heavy metal emissions.

Environmental performance and operational data

Scrap treatment to remove organic and halogen contamination may be applied, but usually afterburners are used to treat the gases produced, followed by rapid cooling. When it is not possible to treat the gases from the furnaces in an afterburner, they can be oxidised by adding oxygen above the melting zone.

At the Metallo-Chimique plant in Beerse, the mini smelter furnace is equipped with a separate end-of-pipe adsorption filter with Sorbalit injection. An afterburner is installed at the furnace mouth (see Figure 5.7).

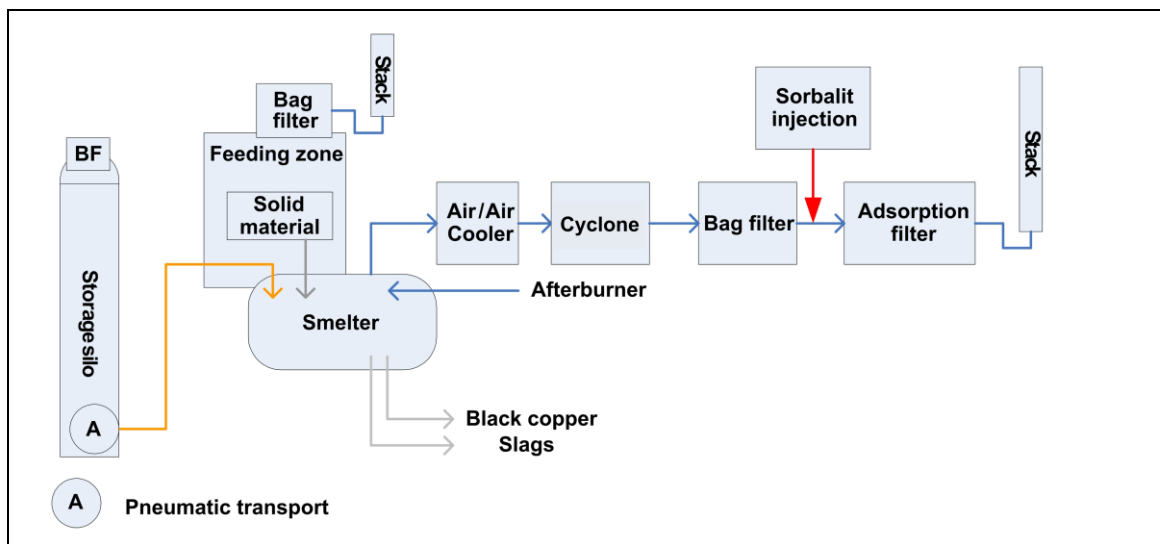

Figure 5.7: Flow chart showing PCDD/F abatement techniques at Metallo-Chimique Beerse

The end-of-pipe adsorption filter has a capacity of $100\ 000\ \text{Nm}^3/\text{h}$. PCDD/F are measured twice a year for six hours. Levels of $< 0.1\ \text{ng I-TEQ/Nm}^3$ are maintained. The final dust emission is monitored continuously by a triboelectrical system.

At the Aurubis plant in Hamburg, the thermal destruction of dioxins is achieved in the electric furnace at a high temperature (above $950\text{ }^{\circ}\text{C}$), followed by rapid gas cooling, to prevent the further reformation of dioxins. Further treatment in an acid plant also avoids the formation of dioxins.

At the Umicore plant in Hoboken, an ISASMELT smelter with a $1000\ \text{t/d}$ capacity (batch process) is used. The flue-gas is sent to the sulphuric acid plant. Its reported concentration of PCDD/F after the sulphuric acid plant is $< 0.001\ \text{ng I-TEQ/Nm}^3$ (spot sample, six-hour average). At the blast furnace, the gases are afterburnt in two stages and filtered twice. PCDD/F concentrations are below $0.005\ \text{ng I-TEQ/Nm}^3$.

Table 5.43 shows data on dioxin emissions monitored in some EU-28 plants, as provided by ILA.

Table 5.43: PCDD/F emissions from lead and tin furnaces

Plant	Technique	PCDD/F emissions (ng I-TEQ/Nm ³)			Furnaces	Monitoring frequency
		Min.	Avg.	Max.		
1	Afterburner, dioxins recreated in economiser and lime injection	0.1	0.2	0.3	Shaft	Once a year
5	Post-combustion chamber, high-temperature bag filtration, liquid media, flue-gas desulphurisation	0.1	0.1	0.1	Reverberatory and rotary combination	Once a year
6	Bag filter	0.1	0.1	0.1	SRF	Once every 3 years
7	NR	< 0.01	0.025	0.08	Rotary A	5 times per year
	NR	0.01	0.1	0.21	Rotary B	4 times per year
9	Afterburner chamber, rapid off-gas cooling, dioxins partly recreated in economiser and lime injection	0.01	0.04	0.2	Shaft	Once every 3 years
11	Afterburner	0.0181	0.038	0.0584	Shaft	Spot sample (3 times per year)
12	Bag filter	0.05	0.05	0.05	Smelter	Once a year
13	Sorbait injection + bag filter	< 0.005	< 0.005	< 0.005	Smelter	Twice a year
14	Bag filter	0.0187	0.0413	0.0639	Rotary	Twice a year
15	Afterburner + bag filter	NR	< 0.005	NR	Blast	Once a year
	Sulphuric acid plant	NR	< 0.001	NR	ISASMELT	Twice a year

NB: NR = Not reported.
Source: [378, Industrial NGOs 2012]

For absorbent injection, the quantity and composition of the additive depends to a large extent on the process conditions and the origin and composition of the input materials. In order to reduce the costs of adsorbents, all or some filter dust can be returned to the process.

Cross-media effects

Reducing the organic and/or halogen (e.g. Cl, Br) content in the feed materials

- Increase in energy use.
- Cost of the additional equipment required and/or use of additives.

Using optimum combustion conditions

No information provided.

Oxygen injection in the upper zone of a furnace

Increase in cost due to the cost of the oxygen.

Applying a post-combustion chamber, afterburner or RTO

- Increase in energy use.
- Cost of the additional equipment.
- Could also increase the NO_x emissions.

Using charging systems that allow small additions of raw materials into semi-closed furnaces

No information provided.

Thermal destruction of dioxins in the furnace at high temperatures (> 850 °C), rapid quenching of off-gases between 400 °C and 200 °C, and avoiding exhaust systems with high dust build-up for temperatures of > 250 °C

No information provided.

Injection of adsorption agent (e.g. activated carbon, lignite coke, lime) before dedusting

Increase in cost due to need for additives and cost of waste processing.

Efficient dust collection system.

The collected dust may have high PCDD/F concentrations and may need to be disposed of, or treated carefully by returning it to the production process.

Technical considerations relevant to applicability

The techniques are applicable to lead and tin circuits in new and existing copper plants, depending on the type of raw material and furnace used.

Reducing the organic and/or halogen (e.g. Cl, Br) content in the feed materials

The techniques used to control, select and sort the raw materials and the scrap inputs depend on the type of furnace and the process used.

Using optimum combustion conditions

Generally applicable.

Oxygen injection in the upper zone of a furnace

Generally applicable.

Applying a post-combustion chamber, afterburner or RTO

Generally applicable.

Using charging systems that allow small additions of raw materials into semi-closed furnaces

Generally applicable, depending on the type of furnace and the process used.

Thermal destruction of dioxins in the furnace at high temperatures (> 850 °C)

Generally applicable.

Rapid quenching of off-gases in the temperatures range between 400 °C to 200 °C

Generally applicable. For thermal recovery, dioxins could be formed by de novo synthesis.

Avoiding exhaust systems with high dust build-up for temperatures of > 250 °C

Generally applicable.

Injection of adsorption agent (e.g. activated carbon, lignite coke, lime) before dedusting
Generally applicable.

Efficient dust collection system.
Generally applicable.

Economics

In order to reduce the costs of adsorbents, flue-dust can be returned to the process.

Driving force for implementation

Environmental regulation requirements.

Example plants

Metallo-Chimique Beerse (BE), Aurubis (DE), Umicore (BE), and BMG Metall und Recycling GmbH (AT).

Reference literature

[397, ILA 2012]

5.3.5 Remelting and refining, alloying and casting in lead and tin production

5.3.5.1 Techniques to prevent and reduce emissions from remelting, refining, and casting in primary and secondary lead and tin production

Description

The techniques to consider are:

- temperature control of the melt;
- closed mechanical skimmers to remove dusty dross/residues;
- lids, or hoods on the furnaces or kettles with fume extraction (see Section 2.12.4.3);
- bag filter (see Section 2.12.5.1.4);
- wet scrubber (see Sections 2.12.5.1.6 and 2.12.5.2.2);
- vacuum smelting and refining technology.

Technical description

Techniques applied for the reduction of emissions depend on the different refining steps and the form of the reaction product in lead refining.

Temperature control of the melt

Good temperature control of the melt bath is important to reduce the emissions of lead and other gas pollutants, and also for process control. It is also important for the furnace energy efficiency.

Tin emissions can be avoided if the temperature of the melt in refining and casting operations is below 500 °C. Indeed, as shown in Figure 5.8, the vapour pressure of tin is very low (negligible compared to lead) up to temperatures of several hundred degrees Celsius above the melting point of tin. This figure has been created by Metallo-Chimique based on the data mentioned in [364, Metallo-Chimique 2014].

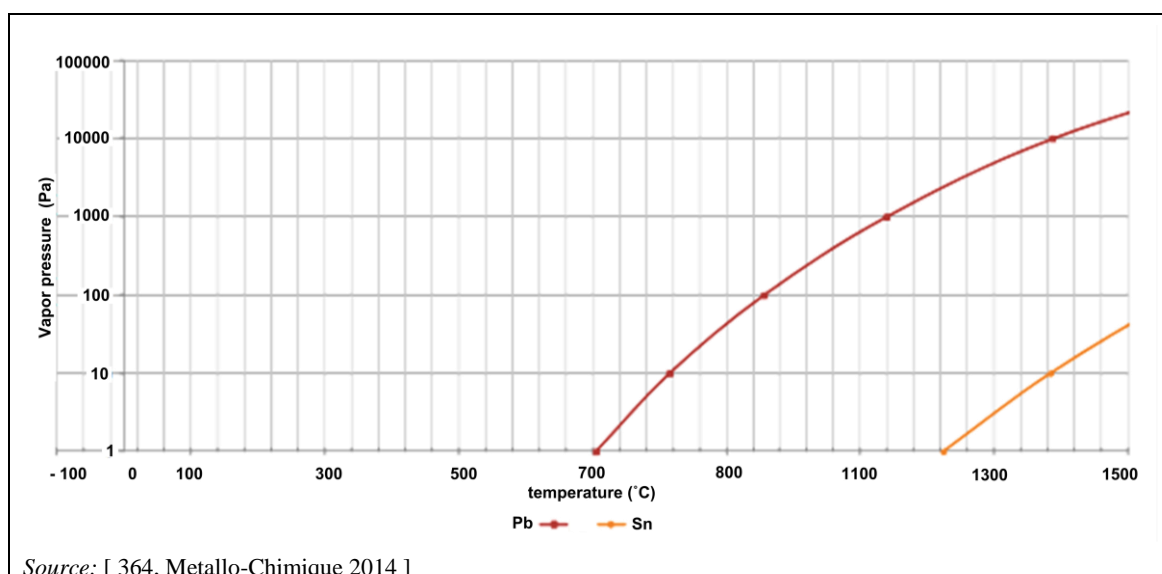

Figure 5.8: Comparison between lead and tin vapour pressures

Closed mechanical skimmers to remove dusty dross/residues

Dusty dross/residues are removed by a closed mechanical skimmer and are then discharged in closed containers.

Lids, or hoods on the furnaces or kettles with fume extraction (see Section 2.12.4.3)

A crucible furnace or kettle is applied to melt lead and tin material. To collect the emissions, an extraction hood is placed on the crucible furnace or kettle. Refining kettles can be covered with lids that remain closed during the refining reaction and the addition of chemicals. Molten lead is automatically pumped in a closed system and transferred from one refining step to another. Fume extraction should also be used at the launders and tapping points. The collected emissions are subsequently sent to a bag filter, or to a wet scrubber in the case of exhaust gases from wet refining processes or gases containing sticky material, e.g. sodium hydroxide.

Vacuum smelting and refining technology

A lead-tin alloy can also be separated into lead and tin by vacuum distillation at high temperatures.

For the other techniques, see the sections referred to above.

Achieved environmental benefits

Temperature control of the melt

Prevention of heavy metal emissions and reduction in energy consumption.

Closed mechanical skimmers to remove dusty dross/residues

Prevention of diffuse emissions.

Lids, or hoods on the furnaces or kettles with fume extraction

Reduction of diffuse emissions.

Bag filter

- Reduction of dust and heavy metal emissions.
- Reduction in raw material consumption.
- Collected material is recycled in the smelting process.

Wet scrubber

See Sections 2.12.5.1.6 and 2.12.5.2.2.

Vacuum smelting and refining technology

Reduction of dust and heavy metal emissions.

Environmental performance and operational data

Remelting, refining and alloying is usually carried out in indirectly heated crucible furnaces or kettles heated by electricity, oil or gas. Direct heating of the kettle with a gas burner is also applied. Refining kettles are not considered suitable for melting scrap (lead and tin) which contains higher amounts of organic materials. All equipment is installed in a building with additional measures applied to prevent emissions escaping outside.

At Metallo-Chimique, vacuum distillation is used to separate a lead-tin alloy. Kettles are used for (re)melting and refining. Table 5.44 shows the dust emissions from these processes.

Table 5.44: Emissions from the refining process in Metallo-Chimique Beerse

Furnace type	Gas treatment	Emissions
Kettles	Bag filter	Dust < 5 mg/Nm ³
Vacuum furnace	None	Not relevant
<i>Source: [397, ILA 2012]</i>		

At Aurubis Hamburg and at KGHM's plant in Legnica, refining kettles are covered with lids. Lids are closed during the refining reaction and the addition of chemicals. Only large blocks/scrap are fed into the furnace. Fume extraction is applied. Molten lead is automatically pumped in a closed system and transferred from one refining step to another. Dusty dross/residues are removed by a closed mechanical skimmer and discharged into closed containers. Hoods are installed to capture fumes arising from lead casting. All the collected gases from the refining steps are treated in a centralised bag filter. In the cleaned off-gas, levels of dust between 0.5 mg/Nm³ and 10 mg/Nm³ (half-hourly average) and between 0.5 mg/Nm³ and 4.9 mg/Nm³ (daily average) are reported based on continuous measurement.

In the lead refinery of Umicore Hoboken, impure lead is refined in a series of kettles, which are heated with low-NO_x gas burners. The residual heat of the burners is used to produce steam of 10 bar in a boiler. All kettles are provided with closed lids and held in a negative pressure. Dross removal is done automatically under aspiration with a closed skimming system. The air of all dry processes is cleaned in a bag filter. The Sb, Sn and As salts are removed from the lead in the Harris process and treated further in a hydrometallurgical process. Exhaust gases and vapours from these processes, together with the exhaust gases from kettles where sodium hydroxide is used, are cleaned with a wet scrubber.

Table 5.45 shows emissions data from the refining and casting process.

Table 5.45: Data emissions from refining and casting

Plant	Technique	Pollutant	Emission (mg/Nm ³)			Monitoring
			Min.	Avg.	Max.	
2.1	Bag filter	Dust	0.28	0.44	1.02	Continuous (Daily average)
		Dust	NR	1.56	NR	Once a year
		Pb	NR	0.04	NR	
2.2	Bag filter	Dust	0.27	0.64	2.75	Continuous (Daily average)
		Dust	NR	0.61	NR	Once a year
		Pb	NR	0.08	NR	
2.3	Bag filter	Dust	0.33	0.46	2.37	Continuous (Daily average)
		Dust	NR	0.32	NR	Once a year
		Pb	NR	0.14	NR	
2.4	Bag filter	Dust	0.14	0.23	3.81	Continuous (Daily average)
		Dust	NR	0.79	NR	Once a year
		Pb	NR	0.06	NR	
2.5	Bag filter	Dust	0.16	0.26	0.94	Continuous (Daily average)
		Dust	NR	1.1	NR	Once a year
		Pb	NR	0.04	NR	
2.6	Bag filter	Dust	0.13	0.4	2	Continuous (Daily average)
		Dust	NR	1.3	NR	Once a year
		Pb	NR	0.03	NR	
2.7	Bag filter	Dust	0.98	1.78	3	Continuous (Daily average)
		Dust	NR	0.35	NR	Once a year
		Pb	NR	0.25	NR	
5.1	Bag filter (85 000 Nm ³ /h)	Dust	0.015	0.097	0.26	4 times per year (4-hour samples)
		Pd	0.003	0.014	0.033	
		Cd	0	0	0	
		Cu+Pb+Zn+Ni and compounds	0.005	0.017	0.036	
		Sb+Sn+Te and compounds	0.004	0.005	0.006	
		Cd+As+Hg+Tl+Se and compounds	0.006	0.008	0.01	
		TVOC	12.3	15	17.6	Twice a year (4-hour samples)
		PCDD/F (ng I-TEQ/Nm ³)	0.05	0.05	0.05	Once a year
5.2	Venturi wet scrubber, bag filter (42 000 Nm ³ /h)	Dust	0.3	1	10	4 times per year (4-hour average)
		Pb and compounds	0.009	0.39	1.3	
		Cd and compounds	0.001	0.001	0.003	
		Cu+Pb+Zn+Ni and compounds	0.09	0.41	1.3	
		Sb+Sn+Te and compounds	0.003	0.032	0.094	
		Cd+As+Hg+Tl+Se and compounds	0.007	0.027	0.054	
		VOCs (as carbon)	9.5	29.3	49	Twice a year (4-hour samples)
		HCl	0.17	0.17	0.17	Once a year (4-hour samples)
		SO ₂	1	5	10	Once a year (4-hour samples)
				PCDD/F (ng I-TEQ/Nm ³)	0.06	

6.1	Bag filter (kettle suction)	Dust	< 1	< 1	< 1	Continuous (Half-hourly average)
		Pb	< 1	< 1	< 1	Once a year
		Hg+Tl	< 0.01	< 0.01	< 0.01	
		Pb+Ni+Se	< 0.05	< 0.05	< 0.05	Once every 3 years
		Sb+Cu+Sn	< 0.1	< 0.1	< 0.1	
As+Cd	< 0.01	< 0.01	< 0.01			
7.1	Bag filter	Dust	< 0.5	1	4.6	5 times per year
		Pb	< 0.05	0.11	0.4	
		As+Cd	< 0.005	0.07	0.26	
7.2	Bag filter	Dust	< 0.5	0.16	0.3	3 times per year
		Pb	< 0.1	< 0.1	< 0.1	Once a year
		As+Cd	< 0.05	< 0.05	< 0.05	
10.1	Bag filter	PM ₁₀	0.02	0.82	2	4 times per year
		Cu in dust	0.0003	0.006	0.04	
		Pb in dust	0.0008	0.11	0.8	
		As in dust	0.0001	0.004	0.028	
		NO ₂	0.02	2	36	
		SO ₂	0.15	1.6	21	
		CO	2.5	15	37	
10.2	Bag filter	PM ₁₀	0.02	0.82	2	4 times per year
		Cu in dust	0.0003	0.006	0.04	
		Pb in dust	0.0009	0.11	0.8	
		As in dust	0.0001	0.0042	0.028	
		NO ₂	0.02	2	36	
		SO ₂	1.5	180	770	
		CO	2.5	15	37	
13	Bag filter	PM ₁₀	NR	< 0.5	NR	Twice a year (4-hour samples)
		Cu		< 0.0005		
		Pb		0.0011		
		Zn		0.0018		
		Cd		< 0.0005		
		As		< 0.0005		
		Sb		< 0.0005		
		Ni		< 0.0005		
14	Bag filter	Dust	0.17	1.4	4.6	Once every 15 days
		Pb	0.001	0.04	0.4	
		Zn+Sb+Cu+Cr +Mn+As+Cd+Ni	0.003	0.04	0.13	
15.1	Bag filter (90 000 Nm ³ /h)	Dust	0.02	0.2	0.86	Dust 6 times per year Metal twice a year (samples of 3–5 hours)
		Pb	0.02	0.06	0.09	
		Cu	0.005	0.006	0.007	
		As	0.0007	0.004	0.007	
		Sb	0.02	0.25	0.49	
		Zn	0.007	0.008	0.008	
15.2	Scrubber (70 000 Nm ³ /h)	Dust	0.42	2.17	6.01	13 times per year (samples of 2–5 hours)
		Pb	0.01	0.17	1.19	
		Cu	0.0004	0.01	0.05	
		As	0.001	0.02	0.09	
		Sb	0.14	0.92	2.18	
		Zn	0.0006	0.03	0.2	
16	Suction hoods, bag filter,	Dust	0.03	0.31	0.84	24 times per year
		Pb	0.02	0.13	0.4	12 times per year
		Cd	< 0.001	< 0.001	0.002	

	induced draught fans	Sb	< 0.001	< 0.001	0.011	
18	Bag filter (100 000 Nm ³ /h)	Dust	0.5	NR	4.9	Continuous (Daily average)
		Cu	< 0.01		0.1	4 times per year (3 samples of 30 minutes)
		Pb	0.01		0.31	
		Ni			< 0.02	
		As	< 0.01		0.3	
		Cd	< 0.01		0.02	
NB: NR = Not reported. Source: [378, Industrial NGOs 2012] [385, Germany 2012]						

Cross-media effects

Temperature control of the melt

No information provided.

Closed mechanical skimmers to remove dusty dross/residues

No information provided.

Lids, or hoods on the furnaces or kettles with fume extraction

No information provided.

Bag filter

- Increase in energy use.
- Treatment of dust to recover the metals has to be done internally or externally.

Wet scrubber

See Sections 2.12.5.1.6 and 2.12.5.2.2.

Vacuum smelting and refining technology

No information provided.

Technical considerations relevant to applicability

The techniques listed above are generally applicable.

Economics

No information provided.

Driving force for implementation

Environmental regulation requirements.

Example plants

KGHM (PL), Muldenhütten Recycling und Umwelttechnik (DE), BSB Recycling (DE), HJ Enthoven & Sons (UK), Metallo-Chimique (BE), Weser-Metall (DE), Aurubis (DE), and Umicore (BE).

Reference literature

[397, ILA 2012]

5.3.6 Waste water

5.3.6.1 Techniques to prevent waste water

Description

For all waste water produced in a lead and tin production plant, waste water treatment is required before discharge [397, ILA 2012].

The amount of waste water to be treated can be reduced by the following techniques.

- Employing multiple uses of the same waste water flows:
 - by cascading cooling water;
 - by reusing cooling water or condensed steam for process purposes;
 - by reusing process water for another application if feasible.
- Avoiding wet process gas treatment techniques.
- Using closed loop cooling with air coolers as secondary heat exchangers.
- Minimising the drain of evaporation coolers.
- Recirculating water flows after treatment for reuse.
- Separating uncontaminated water flows (e.g. rainwater, non-contact cooling water) from process water flows. Note: contact cooling water is considered process water.

Technical description

Multiple uses of the same waste water flows by reusing condensed steam for process purposes

In the alkaline leaching process, when the crystallisation of sodium sulphate takes place the water resulting from the crystallisation is used to make the alkali salt solution.

Achieved environmental benefits

- Reduction of fresh water used.
- Reduction of energy used for pumping water.
- Reduction of the amount of reagents used in the waste water treatment plant.
- Reduction of the amount of waste water emitted and of the pollutants contained in the waste water.
- Reduction of the heat transferred to the receiving water body.

Environmental performance and operational data

At Umicore Hoboken, the water that is injected to cool the smelter gases is condensed together with the water from the raw materials and is reused for quenching this gas flow. At the blast furnace, a dry gas treatment process avoids the use of water. At the lead refinery, all dry gases are treated in a bag filter; only the gases with a more elevated water content or with sticky material are cleaned in a wet scrubber. Rainwater, excess sprinkling water, cooling water, and drainage water are collected in a sewer system and are treated in order to be reused as sprinkling water and cooling water, thus providing 60 % of the total amount of water needed in the plant. The minimised drain of evaporation cooling towers is applied.

Cross-media effects

- Increase in investment cost.
- Increased complexity of the process.

Technical considerations relevant to applicability

Multiple uses of the same waste water flows and recirculating water flows after treatment for reuse

These techniques can only be applied if the required criteria for the next application are met in terms of flow rate, temperature, composition and acidity.

Avoiding wet process gas treatment techniques

This technique is not applicable when the gases to be treated contain a lot of water, acid mist or sticky substances.

Closed loop cooling with air coolers as secondary heat exchangers

This technique requires a suitable area as more space is required to install air coolers, and due to the air coolers' less efficient heat transfer compared to evaporation coolers.

Economics

In existing plants, implementation of these techniques might involve high investment costs.

Multiple uses of the same waste water flow

This requires additional investment in intermediate storage capacity, in order to balance the inputs and outputs of the dependent processes.

Separating uncontaminated water flows from process water flows

An economic consideration has to be made for the investment in separate sewer systems, factoring in the amount of uncontaminated rainwater that could potentially be recovered.

Driving force for implementation

- Environmental regulation requirements.
- The prevention of waste water generation decreases the treatment costs of a waste water treatment plant.

Example plants

All plants in Europe.

Reference literature

[254, VDI 2004], [397, ILA 2012]

5.3.6.2 Inorganic waste water treatment process**Description**

Most EU-28 plants apply the inorganic treatment process to their waste water. This process includes the following steps:

- settlement;
- possibly oxidation;
- hydroxide precipitation;
- sulphide precipitation;
- possible addition of an iron(III) sulphate solution when surplus sulphide is present;
- addition of FeCl_3 in order to remove arsenic;
- filtration;
- pH adjustment.

Technical description

A treatment plant for waste water has several stages that are applied for all types of waste waters. In general, the separate treatment or pretreatment of individual waste water streams has no advantage, as the quality of the waste water achieved is not improved [397, ILA 2012].

In the EU-28 lead and tin plants, a typical waste water plant has hydroxide precipitation, in some cases followed by sulphide precipitation. Polishing of arsenic can be done using FeCl_3 . If needed (i.e. for direct discharge to rivers), any sulphide surplus can be eliminated by the addition of an iron(III) sulphate solution.

Settlement and possibly oxidation

All production waste waters can be passed to a collection pond with a sufficient capacity to store the waste water. The entrance area of this pond has a water underflow, so that fractions which float (wood, plastic, oil, etc.) can be removed. Adding either sulphuric acid or sodium hydroxide ensures that the pH is held in a range which is acceptable for dosing in the following reaction tank. With higher contents of sulphites in the water, oxidation may be necessary (air or chemicals).

The same arrangement can be used for rainwater. In this case, some water may be pumped back for reuse.

Hydroxide precipitation

The liquor is pumped into a tank with a stirrer. The pH is adjusted to 9.5–10.0 by adding sodium hydroxide and flocculation agents. Hydroxide flocs are removed by filtering or settling and filtering. In this step, or in a second hydroxide precipitation step, FeCl_3 can be added in order to remove arsenic from waste water.

Sulphide precipitation

The water can pass to the second reaction tank in which dosing with sulphuric acid ensures a pH of 7.5–8.5. The addition of sodium sulphide/sodium hydrogen sulphide solution causes a reaction with the remaining dissolved metal ions to form a heavy soluble sulphide precipitate, which can be removed by filtering or settling and filtering.

Addition of an iron(III) sulphate solution

If surplus sulphide is present in the water, the addition of an iron(III) sulphate solution can be performed to eliminate excess sulphide. The water is then filtered (i.e. filter press plus sand filter or membrane filter) to remove the precipitate.

Uncontaminated cooling water is preferably reused; if necessary, cooled down first with an air cooler. If this is not possible, it may be discharged separately, if the receiving water can accept the thermal burden.

Depending on local conditions, pretreatment steps to remove solids with the most metals may be needed to reduce contamination of the public sewage sludge, especially if used for agriculture.

When the lead plant is situated within a copper smelter, the relatively minor streams of waste water from the lead plant are discharged into the relevant waste water systems; rainwater and bleed from the cooling system are discharged to the waste water sewer and finally to the waste water treatment plant. The technology is based on rainwater retention and final coagulation with the aid of polyelectrolyte.

Sanitary waters have a separate sewerage system and are released to a public sewerage system or a suitable septic tank.

Achieved environmental benefits

Reduction of the pollutant content in the waste water.

Environmental performance and operational data

Waste water is continuously monitored with volume measurement and pH probes. Water quality is sampled on a continuous basis (daily, shift or other) or by random sampling, according to permit conditions. The samples are analysed for Pb, Cd, As, Cu, Fe and sometimes other metals and other parameters, again according to permit conditions. Depending on local conditions and production technology, the volume of waste water can be up to 6 m³ per tonne of lead [397, ILA 2012].

Table 5.46: Emissions to water from lead and tin production plants

Plant (receiving water body)	Waste water and Technique	Pollutant	Values (mg/l)			Monitoring frequency
			Min.	Avg.	Max.	
1 (Sea)	Process waste water and collected rain/drainage water from plant area	Pb	< 0.01	0.04	0.06	Continuous composite sampling and measurement (weekly average)
		Zn	< 0.005	0.01	0.02	
		Cd	< 0.001	0.004	0.005	
	Precipitation of metal hydroxides by use of sodium hydroxide (caustic)	As	< 0.02	0.01	0.02	
		Cu	< 0.005	0.007	0.03	
2.4 (River)	Rainwater and site drainage surface water	Pb	< 0.001	0.096	0.267	128 times per year (i.e. every discharge)
		As	0.004	0.032	0.071	
		Cd	0.001	0.007	0.023	
		Cu	< 0.001	0.016	0.034	
		Ni	0.007	0.05	0.201	
		Zn	0.005	0.143	1.072	
	Flocculation, pH adjustment, filtration and final pH adjustment prior to discharge	Sb	0.04	0.196	0.465	Single random sample and measurement
		Susp. solids	3	10	25	
		pH	7.4	8.2	9	
		Ag	< 0.001	< 0.0 01	0.001	
4 (River)	Process waste water and rainwater	Pb	0.1	0.22	0.4	Spot measurement and periodic measurement (monthly average)
		Ni	0.01	0.02	0.03	
	Combinations of physical and chemical treatments	Cu	< 0.005	0.008	0.03	Composite sampling (weekly average)
5 (River)	Process waters and surface run-off water from process plant areas for the recovery of lead from secondary sources pH adjustment, ferric chloride addition, flocculation and sedimentation. Anionic/cationic flocculation, mechanical filtration	Pb (kg/d)	0.06	0.57	1.45	156 times per year Periodic composite sampling and measurement
		Cd (kg/d)	0.003	0.115	0.552	
		Sb (kg/d)	0.002	0.212	1.096	
		As (kg/d)	0.001	0.018	0.092	
		Cu (kg/d)	0.001	0.017	0.046	
		Hg (kg/d)	0.001	0.002	0.009	
		Ni (kg/d)	0.001	0.13	0.428	
		NH ₄ (as ammoni um) (kg/d)	0.21	2.47	6.17	
6 (River)	Process water (breaker plant), cooling water (reduction, refinery), surface run-off water (sprinkler system, rain, sweeping machine, etc.)	Pb	NR	< 0.0 5	0.13	50 times per year
		Cu		0.023	0.06	
		Ni		0.096	0.13	Single random sample
		Zn		< 0.0 5	0.62	

(River)	Sedimentation of sludges, sulphide precipitation, neutralisation and agglomeration, sedimentation, ion exchanger, pH control	As		0.011	0.05	Twice a year Single random sample 12 times per year 50 times per year Twice a year Twice a year
		Hg		0.01	0.01	
		Sb		0.084	0.52	
		Cd		0.03	0.22	
		Fe		0.3	1.2	
		N		8	8	
		P		0.05	0.05	
		AOX		0.05	0.06	
		CSB		14	39	
		Hydrocarbons		1	1	
Fish toxicity		2	2			
(River)	Half the treated waste water comes from the secondary lead process (breaker, rotary and refinery plant, and surface run-off water). The other half comes from another activities. Sodium sulphide precipitation, sedimentation + filtration by sand filter	Pb	< 0.05	0.07	0.26	365 times per year Single random sample
		Cd	< 0.005	< 0.05	0.005	
		Cu	< 0.1	< 0.1	< 0.1	
		As	< 0.01	0.02	0.05	
		Ni	< 0.1	< 0.1	< 0.1	
		AOX	< 0.05	0.1	0.237	
		COD	< 15	24	36	
(Public sewage)	Whole plant Four-step treatment: 1. Arsenic stage: arsenic precipitation and flocculation by adding FeCl ₃ , H ₂ O ₂ 2. Hydroxide stage: hydroxide precipitation of several metals (mainly Pb, Cd, Zn) and flocculation by adding Ca(OH) ₂ 3. Thallium stage: thallium precipitation and flocculation by adding Na ₂ S, Al ₂ (SO ₄) ₃ 4. Neutralisation	Pb	0.031	0.05	0.074	820 times per year Single random sample
		Cd	< 0.01	< 0.01	0.13	
		Zn	0.021	0.05	0.6	
		Cu	< 0.05	< 0.05	0.05	
		As	0.01	0.02	0.1	
		Ni	< 0.05	< 0.05	0.2	
		Tl	0.02	0.1	0.9	
		Chloride	971	NR	2580	
		Sulphate	1270	NR	2260	
(River)	Process water, rain and surface water Precipitation of metals by increase of pH value through addition of sodium hydroxide and iron(III) chloride solution (1st step) and ion exchanger (2nd step)	Pb	0.01	0.033	0.2	300 times per year Periodic composite sampling; (weekly average)
		Cd	0.01	0.015	0.03	
		Zn	0.01	0.05	0.1	
		Fe	0.04	0.051	0.06	
		Cu	0.01	0.015	0.02	
		Ni	0.01	0.015	0.1	
11	Rainwater	Pb	0.05	0.05	0.05	12 times per year Periodic composite sample of 24 hours
		As	0.001	0.0015	0.0044	
		Zn	0.01	0.041	0.057	
		Cd	0.005	0.046	0.25	
		Ni	0.015	0.0165	0.033	
		TDS	1200	2899	6600	

(River)	Alkalisiation with Ca(OH) ₂ , flocculation, bentonite	COD	2.5	21.9	44	
		C10-C40	0.01	0.028	0.032	
		TSS	2.5	3.96	14	
12	Mixture of sanitary water, process water and rainwater	Pb	0	0.14	0.3	4 times per year Spot measurement
(NR)	Physico-chemical purification process	Cu	0	0.61	1	
		Cd	0.068	0.13	0.165	
		Zn	0.32	0.89	1.2	
		Ni	0	0.01	0.02	
		As	0	0	0	
		Na	550	674	950	
		Sn	0.13	0.42	0.66	
		Fe	0	0.05	0.2	
		Sulphides	483	528	590	
13	Mixture of sanitary water, process water (multi-metallic) and rainwater Physico-chemical purification process (adding of iron trichloride, adding of lime milk, adding of polyelectrolyte. Suspended particles removed by a settler. Sludge removed by a press filter. Before discharging, water is filtered by a sand filter and pH adjusted by CO ₂ addition	Pb	0.02	0.022	0.029	5 times per year Periodic composite daily sampling
(Public sewage)		Cu	0.0257	0.0323	0.044	
		Cd	0.001	0.0012	0.0018	
		Zn	0.0232	0.0369	0.066	
		Ni	0.056	0.062	0.075	
		As	0.0178	0.0198	0.0207	
14	Water from cleaning works, rainwater and water from polypropylene stage cleaning Physical and chemical treatment with NaOH to adjust pH, and flocculants to eliminate pollutant elements	Pb	0.02	0.103	0.25	Every 7–10 days Single random sampling
River		As	0.1	0.1	0.1	
		Cd	0.09	0.242	0.7	
		Ni	0.25	0.645	2.47	
		Cu	0	0	0	
		Zn	0.18	0.7467	2	
		pH	8.4	8.93	9.48	
15	Process waste water, rainwater, excess sprinkling water, cooling water and drainage water Physical chemical treatment with lime addition, As polishing with FeCl ₃ , final polishing with NaSH	Pb	0.005	0.02	0.04	12 times per year Continuous composite sampling
(River)		Cd	0.003	0.007	0.011	
		Zn	0.01	0.03	0.05	
		Cu	< 0.002	0.01	0.05	
		As	0.04	0.09	0.17	
		Ni	0.01	0.03	0.05	
		Tl	< 0.01	0.22	0.83	
		Sn	0.03	0.14	0.31	
		Sb	< 0.01	0.14	0.31	
		AOX	0.88	1.8	2.9	
16	Waste water from lead and zinc plants Three step treatment: 1. Hydroxide stage:	Sulphide (dissolved):	< 0.04	NR	0.09	15 measurements in 2008–2010
		Pb	0.001		0.05	
		Cd	< 0.0005		0.01	

	hydroxide precipitation of several metals and flocculation by adding NaOH, filtration of separated hydroxides 2. Sulphide stage: precipitation of still dissolved metal ions by adding S ²⁻ ions 3. Fe(III) stage: precipitation of surplus sulphide ions by adding Fe ³⁺ ions, filtration of precipitate	Cu	< 0.01		0.04		
		Hg	< 0.0005		0.00066		
		Tl	0.01		0.85		
		Zn	< 0.01		0.14		
		As	0.00052		0.29		
		Ni	< 0.01		0.04		
		Fe	0.03		2.8		
18.1	Process water from the whole site: gas washing primary copper smelter and secondary copper/lead smelter, effluents from acid plant, precious metals plant and selenium plant	Pb		NR	0.03*	0.05	Single random sample and measurement (monthly average)
(River)		Cu			0.05*	0.2	Single random sample and measurement (weekly average)
		As			0.06*	0.09	Single random sample and measurement (monthly average)
		Ni			0.05*	0.06	Single random sample and measurement (weekly average)
	As removal with iron(III), neutralisation and precipitation of metals (1st step) and sulphide precipitation together with iron(II)	Zn			0.17*	0.2	Single random sample and measurement (weekly average)
		Cd			0.01*	0.02	Single random sample and measurement (monthly average)
		Hg			0.019*	0.024	Single random sample and measurement (weekly average)
18.2	Surface run-off water from secondary copper/lead smelter, shapes installation, lead refinery	Pb		NR	0.14*	0.5	Single random sample and measurement (monthly averages)
(River)		Cu			0.18*	0.5	Single random sample and measurement (weekly average)
		As			0.03*	0.09	Single random sample and measurement (monthly averages)
		Ni			0.14*	0.5	Single random sample and measurement (weekly average)
	Treatment by coagulation, hydroxides precipitation by pH adjustment, flocculation and settling	Zn			0.25*	1	Single random sample and measurement (weekly average)
		Cd			0.05*	0.11	Single random sample and measurement (monthly averages)
		Hg			0.0065*	0.014	Single random sample and measurement (weekly average)
<p>* 90th percentile. NB: NR = Not reported. Source: [378, Industrial NGOs 2012] [385, Germany 2012]</p>							

Cross-media effects

- Increase in energy use.
- Use of additives.

Technical considerations relevant to applicability

Generally applicable.

Economics

No information provided.

Driving force for implementation

Environmental regulation requirements.

Example plants

All plants in Europe.

Reference literature

[254, VDI 2004], [397, ILA 2012]

5.3.7 Process residues**5.3.7.1 Techniques to prevent and minimise residues and wastes from primary smelters****Description**

In primary lead production, the principal sources of wastes and residues are the other constituents contained in the lead ores and their concentrates. To produce a by-product or reduce the amount of wastes generated from these constituents, the following techniques need to be considered.

- Sulphur recovery: Sulphur is converted to sulphur products such as sulphuric acid, or liquid SO₂.
- Cd removal: Cd is leached from the dust recovered by a hot ESP using sulphuric acid.
- Hg removal: Hg is removed using either the Boliden-Norzink process or filtration with absorbents such as activated carbon.
- Se and Te separation: Se and Te are removed during (wet or dry) gas cleaning. The residues that are formed are landfilled or reused to extract these metals.
- Ag, Au, Bi, Sb and Cu recovery: These metals are removed during refining as a complex element and sent to the recovery stage.
- Metals recovery in a waste water treatment plant.
- Other constituents are processed to produce oxides for recycling, or a crystalline slag.

Technical description

Good waste management practices either enable minimisation of waste material or ensure the waste is transformed into a less harmful material. This can occur via a number of routes, which include concentrating, removing, stabilising, or recycling the undesired components, or by optimisation of the flocculation/filtration conditions to ensure less water in the residue that needs treatment.

Lead ores and concentrates can contain constituents such as S, Fe, CaO, Zn, Cu, SiO₂, Al₂O₃, MgO and BaO, and, in more minor concentrations, Ag, As, Au, Bi, Cd, Hg, Sb, Se and Te. Secondary materials used are typically clean materials (i.e. lead paste from battery processing), but may contain Cu or Sb (scrap, grids, etc.).

Sulphur recovery

Sulphur is converted to sulphur dioxide, which can be used to generate marketable/reusable sulphur-containing products (i.e. sulphuric acid, liquid SO₂, or gypsum). This avoids the generation of waste, which otherwise would have resulted from its abatement, see Section 2.12.5.4.

Cd removal

During smelting, Cd is fumed and is precipitated by the hot ESP. To recover dust with a high lead content, Cd has to be separated out. This is done by a leaching process using sulphuric acid, and Cd is precipitated as CdCO_3 . After a filter press, this material is sent to a suitable landfill. The leaching residue is returned to the furnace process.

Se and Te separation and Hg removal

During wet gas cleaning, Se, Te and some Hg are removed. The complex residue is sent to landfill or used for metal recovery. Residual Hg in the process gas is removed by special processes (e.g. Boliden-Norzink process, Dowa process, or filtration with absorbents such as activated carbon), see Section 2.12.5.5, and the residues are treated and sent to landfill.

Ag, Au, Bi, Zn and Sb and some Cu recovery

These metals are removed during gas cleaning or refining. These metals can be processed to form oxides (e.g. ZnO) and/or an Ag-Au alloy, Pb-Bi alloy, Pb-Sb alloy or Cu matte for own use or sale. This can take place either on or off site. A small quantity of intermediates and/or wastes produced during the refining process are sent back to the smelting process or refinery for internal recycling.

Metals recovery in a waste water treatment plant

Some of the metals are discharged after treatment to the waste water treatment plant (WWTP), see Section 5.3.6.2. The treatment residues from the WWTP are recirculated.

All other components of the lead ore/concentrate go to slag. A crystalline slag is produced which will contain some lead and other metals. The composition of the slag can be controlled before smelting by the addition of fluxes (some of which are waste materials) to achieve a material with good leaching properties. Compounds which are considered low value may be collected as a by-product (with a Pb concentration of $> 40\%$) to be sold to other smelters. In some cases, slags containing Pb, Zn and Cu are further fumed to recover value in downstream processes and to produce a slag that is low in metal and has low leachability and can potentially be used for construction processes.

Achieved environmental benefits

- Recovery of materials.
- Minimisation of environmental risks associated with waste materials going to landfill.

Environmental performance and operational data

No information provided.

Cross-media effects

Sulphur recovery

- Increase in energy use.
- Use of additives.
- Waste could be generated.

Cd removal

- Use of additives.
- Waste is produced that will require disposal.

Hg removal

- Increase in energy use.
- Waste is produced that will require disposal.

Se and Te separation

- Increase in energy use.
- Waste will be produced if Se and Te are not recovered.

Ag, Au, Bi, Sb and Cu recovery

No information provided.

Metals recovery in a waste water treatment plant

No information provided.

Technical considerations relevant to applicability

Generally applicable. The recovery of Se and Te is limited by the quantity of Hg present. Direct smelting of the WWTP sludge can be limited by the presence of elements that disturb smelting such as As, Tl and Cd.

Economics

- Increase in energy use.
- Reduction in disposal costs.

Driving force for implementation

Possible cost reductions for waste disposal will be offset against the higher costs associated with applying the required additional process step.

Example plants

All primary lead production plants in Europe which process ores and/or concentrates.

Reference literature

[397, ILA 2012]

5.3.7.2 External or internal use of acid and plastics from battery treatment**Description**

The recovered sulphuric acid can be:

- used as a pickling agent;
- processed in the chemical industry;
- regenerated by cracking;
- used to form gypsum;
- used to produce sodium sulphate in the desulphurisation process (see Section 5.3.2.5).

Polypropylene is broken into chips and sold for further use, both internally and externally, or processed into pellets.

The other plastics are sent for energy recovery or for waste disposal.

Technical description

Lead-acid batteries (SLI) consist of the following components (wt-%):

- lead (alloy) components (grid, poles, etc.): 20–30;
- electrode paste (fine particles of lead oxide and lead sulphate): 35–45;
- sulphuric acid (10–20 % H₂SO₄): 10–25;
- polypropylene: 5–8;
- other plastic materials and other polymers (PE, etc.): 2–5;
- other materials (glass, inorganics, silicon compounds, etc.): < 1.

The acid and plastic components are processed as follows:

Use of the recovered sulphuric acid

Recovered sulphuric acid is weak and can contain some dissolved impurities, i.e. Fe, which can limit further use. The acid use also depends on the local situation. Different types of use are reported. The recovered sulphuric acid could be used in the following ways.

- Used as a pickling acid, such as for pickling Fe, Zn and brass goods. Acid can have some impurities as it is transformed to FeSO_4 , ZnSO_4 solutions, which are then recovered as salts.
- Used for further processes in the chemical industry.
- Regenerated by cracking. The spent acid is concentrated to remove the water and then sprayed into a furnace at 1000–1200 °C, where the H_2SO_4 is transformed into $\text{SO}_2 + \text{H}_2\text{O}$ and O_2 . The SO_2 is then sent to the sulphuric acid plant.
- Used to form gypsum. In this case, the spent acid is mixed with lime $\text{Ca}(\text{OH})_2 + \text{H}_2\text{SO}_4 = \text{CaSO}_4 \cdot 2 \text{H}_2\text{O}$. The gypsum is separated by filtration.
- Handled together with the lead paste and lime, and sold to primary smelters which use the lime for slag formation and recover new acid from the sulphate content.
- Used to form sodium sulphate in the desulphurisation process (see Section 5.3.2.5). Here, the spent sulphuric acid is added to lead-acid battery paste and alkali salt solution in a desulphurisation reactor, with the H_2SO_4 taking part in the reaction to first form PbSO_4 .

Use of polypropylene (PP)

The battery casings are cleaned to remove the impurities (sulphuric acid and lead) and afterwards they are broken into chips. The waste water is sent to the waste water treatment plant. The material has a high economic value and can be sold as PP chips. Some companies process the PP chips internally, and produce high quality PP compounds in the form of pellets, designed to the customers' specific technical requirements.

Use of other plastics (PE, etc.)

The separators consist of mostly PE, with a high amount of filling material. Depending on the battery technology, the separators can contain lead. As such, this material is destined for energy recovery or for waste disposal. It can also be used as a reducing agent in furnaces.

One smelter has its own waste incineration plant to produce steam for sodium sulphate drying and electrical energy (see Section 5.3.2.5).

The production of battery casing no longer needs ebonite and the content in the collected batteries varies, but is declining. Ebonite is a hard rubber containing high levels of sulphur and filling materials. Depending on the countries, age of car population and origin of the collected batteries, this material may be recovered separately or together with the other plastics fraction. Ebonite has no other use in terms of energy recovery or waste disposal.

Achieved environmental benefits

- Use of the various fractions reduces the amount of waste materials.
- Sulphuric battery acid replaces new sulphuric acid in some applications.
- The manufacture of gypsum saves resources by replacing natural gypsum.
- Recovered PP is used instead of virgin PP.
- Energy recovery from other plastics and ebonite saves or produces energy.

Environmental performance and operational data

In the Harz-Metall plant, the dilute acid captured from the battery yard is treated together with waste water from the battery treatment line in a specially designed waste water treatment plant. Here, the acid is neutralised with lime to precipitate (impure) gypsum. Small quantities of iron chloride may be added to improve the precipitation and settling of impurities from the solution. The precipitates are thickened in a thickener and sent to the filter press, in which paste (fines from battery) is also filtered. The filter cake is shipped to the Ausmelt furnace in Nordenham for lead recovery. The contained gypsum helps to adjust the slag composition as a flux. During

smelting, SO₂ is released and collected in the off-gas treatment section. Finally, H₂SO₄ is regenerated.

Cross-media effects

Use of the recovered sulphuric acid

- As a pickling agent: no information provided.
- Processed in chemical industry: no information provided.
- Cracking: increase in energy use.
- Gypsum production: increase in energy use and use of lime.
- Sodium sulphate production: increase in additives use.

Recovery of PP

Increase in energy use.

Use of other plastics

No information provided.

Technical considerations relevant to applicability

Use of the recovered sulphuric acid

- As a pickling agent: the applicability of this technique depends on the local conditions and the compatibility of the impurities present in the acid with the recovery process.
- Processed in chemical industry: the applicability of this technique depends on the local conditions.
- Cracking: this is only applicable in conjunction with a sulphuric acid plant.
- Gypsum production: the gypsum quality depends on the impurities present in the recovered sulphuric acid.
- Sodium sulphate production: generally applicable.

Recovery of PP

This may not be applicable for shaft furnaces due to the gas permeability of intact batteries which is required by the furnace operations.

Use of other plastics

Depending on the characteristics of the material, it may be preferable to recover them instead of using them in energy production or, if recovery is not possible, to send them to landfill.

Economics

No information provided. Sodium sulphate production is an economic issue, linked to the prices for sodium hydroxide and sodium sulphate.

Driving force for implementation

Environmental regulation requirements.

Example plants

All plants in the EU which carry out battery separation.

Reference literature

[254, VDI 2004], [397, ILA 2012]

5.3.7.3 Techniques to prevent and minimise residues and waste from secondary smelters

Description

The techniques to consider are (in order of preference):

- reintroduce the residues to the smelting process to recover lead and other metals;
- treat the residues and wastes in dedicated plants for material recovery;
- treat the residues and wastes for other useful applications.

Technical description

Reintroduce the residues to the smelting process to recover lead and other metals

For shaft furnaces, most slag is returned to the furnace. For other processes, the slag is also returned to the process when the lead content is high.

Other examples of residues sent to the smelting stage are the following:

- Lead matte.
- Materials obtained from the refinery steps to remove Cu, Sb, Sn, As, precious metals and Bi. These drosses can also be used to produce Cu matte, Pb-Sb or Pb-Sn alloys.
- Waste water treatment residues after dewatering by a filter press. The residues from secondary smelters can be returned to the process due to their lead content.

Treat the residues and wastes in dedicated plants for material recovery

The lead matte can be used in the lead smelting process but can also be sent to primary smelters able to handle this material. Other types of by-product sent to other plants to recover lead are:

- Cu matte to Cu smelter;
- materials obtained from the refinery steps to remove Cu, Sb, Sn, Bi, In, Se, Te and precious metals;
- filter dust.

Treat the residues and wastes for other useful applications

Slags that fulfil the leaching criteria for metals can be used in building applications.

Achieved environmental benefits

Recovery of metals.

Environmental performance and operational data

No information provided.

Cross-media effects

No information provided.

Technical considerations relevant to applicability

During the production of secondary lead and tin products, a broad range of intermediates are formed, depending on the processes applied and the raw materials used. Due to this variety (differing from each other in physical appearance and chemical composition and variable in time), the technical description section includes a description of the most important uses of the by-products. At plant level, other techniques could be applied according to the local conditions and the specific raw materials used. The solutions for the reduction of wastes have to be defined for all intermediates, respecting the above order of preference given in the description section.

Economics

No information provided.

Driving force for implementation

- Environmental regulation requirements.
- Cost-effective.

Example plants

All secondary lead and/or tin production plants in the EU.

Reference literature

[254, VDI 2004], [397, ILA 2012]

5.3.8 Energy**5.3.8.1 Heat recovery from the process gases in primary lead production and in secondary lead and tin production****Description**

The technique to consider is the use of a waste heat boiler to recover the heat from the furnace flue-gas. The residual heat from the burners in secondary smelting and refining operations can also be used for the same purpose.

Technical description

In continuous production processes, the heat of the smelters' process gases can be used to generate hot water or steam using a waste heat boiler.

The following issues should be taken in to account:

- effective safety precautions;
- good cleaning and maintenance during operation and revision;
- limited entrance of 'false air';
- safe operation with fluctuating heat as well;
- dust load of recovery system.

Standard boilers for primary lead production are installed with a radiation channel. The gas leaving the boiler and cooling system should have a temperature of 200–300 °C before dust filtration in the hot ESP. This prevents corrosion from chlorine and also the condensation of sulphuric acid. Flue-gas conditions have to be taken into account to prevent blocking of flue-dust, by applying higher temperatures.

Achieved environmental benefits

Heat and energy recovery.

Environmental performance and operational data

Heat recovery of up to 40 GWh/year is reported in shaft furnace operations.

Cross-media effects

Dioxins could be formed by de novo synthesis if the flue-gases are not cooled quickly in the temperature range between 400 °C and 200 °C.

Technical considerations relevant to applicability

Energy recovery is limited to continuous smelting routes and to residual heat use from the heating system in a refinery. Special care should be taken with the arrangement to prevent high dust loads and corrosion.

Economics

The higher costs associated with the additional equipment required should be compared to the benefit from the reduction of energy costs.

Driving force for implementation

Reduction of energy costs.

Example plants

All plants in Europe.

Reference literature

[254, VDI 2004], [397, ILA 2012]

5.4 Emerging techniques

Desulphurisation of lead battery paste with a (amine)-based solvent

A process to desulphurise lead battery paste using a solvent- (amine)-based system has been developed on a pilot scale in Poland. The process avoids the use of sodium carbonate and the production of white slag. The process is based on the extraction of lead sulphate to a water phase and the subsequent precipitation of lead carbonate and the final regeneration of solvent with gypsum production.

Wet process of the spent battery paste

The CLEP process is operated at a pilot plant in Italy. The process is the production of lead carbonate or oxide and sodium sulphate from spent battery paste in a wet process. There are no emissions to air and lead oxide is reused in the production of battery paste.

Reverse osmosis for the purification of waste water from lead production

The application of reverse osmosis for the purification of used process and cooling water from lead production is under investigation in an industrial-scale demonstration plant. The aim is the reduction of waste water to be disposed of, leading to a reduced emission of metals and a reduced demand for fresh water. The waste waters arising and the recovered metals are returned to the smelter.

Single process to recycle spent lead batteries and to produce new battery grids

A process is being investigated to recycle lead alloys and lead compounds from spent batteries and to produce new battery grids in a single process. The innovative technology is based on the coupling of an electrochemical dissolution process with a galvanic deposition process of lead and lead alloys in a single bath near room temperature. The technology is free of direct CO₂ emission and is claimed to be highly energy-efficient because of the combination of two processes in only one electrochemical cell.

Treatment of pyrometallurgical zinc and lead production slags in a submerged arc furnace

The treatment of slags arising from pyrometallurgical zinc and lead production in a submerged arc furnace, for recovery of zinc and lead and production of a useable and environmentally friendly slag, is being investigated.

Direct smelting lead production

The Outotec flash smelting furnace has been used on a demonstration basis for the production of lead by direct smelting. The use of Waelz kilns for this purpose has also been reported. The literature contains many other potential examples that have not yet been developed beyond the pilot scale.

Using dismantled batteries in a shaft furnace

In one secondary lead production plant in Germany, a process to separate polypropylene and other plastic content prior to a shaft furnace plant, as well as a process to operate the shaft furnace with dismantled batteries, is under development.

Horizontal air curtain across the top of a steel kettle containing lead

Britannia Refined Metals' plant in the UK is testing the use of a horizontal air curtain across the top of a steel kettle containing lead. The air sweeps lead fume emissions from the kettle towards an extraction unit that captures the emissions. The benefit is in the capture of fume from a hot kettle, which is being charged with lead blocks using an overhead crane.

Achieved environmental benefits

- Recovery of lead fume.
- Reduction of emissions.

Environmental performances and operational data

To be determined.

Cross-media effects

- Increase in investment cost (due to additional equipment to be installed).
- Increase in energy consumption.

Technical considerations relevant to applicability

No information provided.

Economics

No information provided.

Driving force for implementation

Reduction in emissions whilst charging the kettle.

Example plants

Britannia Refined Metals (UK).

Reference literature

[397, ILA 2012]

6 PROCESSES TO PRODUCE ZINC AND CADMIUM

6.1 Applied processes and techniques

Zinc and cadmium are often associated together in ores and concentrates and a number of techniques are used to extract and separate the metals. When a significant quantity of lead is present in the raw material as well, the chemical state (sulphidic or oxidic) and the relative proportion of the metals are among the key factors that determine the pyrometallurgical or hydrometallurgical techniques or combinations that are used. Some of the techniques are also used for secondary or mixed primary and secondary raw materials [11, Hatch Associates Ltd 1993], [99, Hähre, S. 1998].

Other metals (In, Ge, Ga) are sometimes present in the concentrates that are used for zinc and lead production (see Section 6.1.4.3).

6.1.1 Primary zinc

Zinc can be produced from primary raw materials by pyrometallurgical or hydrometallurgical methods. Pyrometallurgical methods are still used in other parts of the world but have gradually lost their importance and are no longer used in the EU for treating simple zinc concentrates. Determining factors are the need for an extra distillation stage to obtain high-grade zinc and the relatively low zinc extraction efficiency. The majority of the pyrometallurgical Imperial Smelting Furnaces have closed down in the EU but one remains open in Poland.

6.1.1.1 Environmental issues

Most zinc-containing ores and concentrates also contain sulphides. This means that zinc metallurgy has similar problems to those found in the sulphuric acid industry, i.e. emissions of residual sulphur dioxide, NO_x, and acid waste water, and release of metals such as arsenic, mercury and cadmium. In cases where zinc-bearing residues containing particular organics are treated, persistent organic pollutants need to be addressed. Zinc ores contain iron, which poses one of the main problems because of the generation of large volumes of residues such as slag, jarosite, goethite and haematite.

Environmental control therefore requires systems for fixing sulphur dioxide, control of particulate and gaseous emissions to the atmosphere, safe disposal of waste, maintenance of a safe in-plant working environment and limiting liquid effluent discharge to environmentally acceptable levels of harmful substances. Releases to atmosphere and water, waste management and energy considerations are among the key factors that influence the choice of techniques to employ.

6.1.1.2 The pyrometallurgical route

The pyrometallurgical route is used for mixed zinc-lead concentrates and secondary material (zinc alloys scrap, zinc dross, etc.) and uses the Imperial Smelting Furnace (ISF), illustrated in Figure 6.1 and Annex 13.1. It can be used on a campaign basis, treating sulphidic concentrates and some secondary lead in one campaign and then washed Waelz oxide and other oxidic materials containing zinc and lead in another campaign. The lead-containing residues and some lead produced in the sulphidic campaign are used to optimise the zinc to lead ratio for the oxidic campaign.

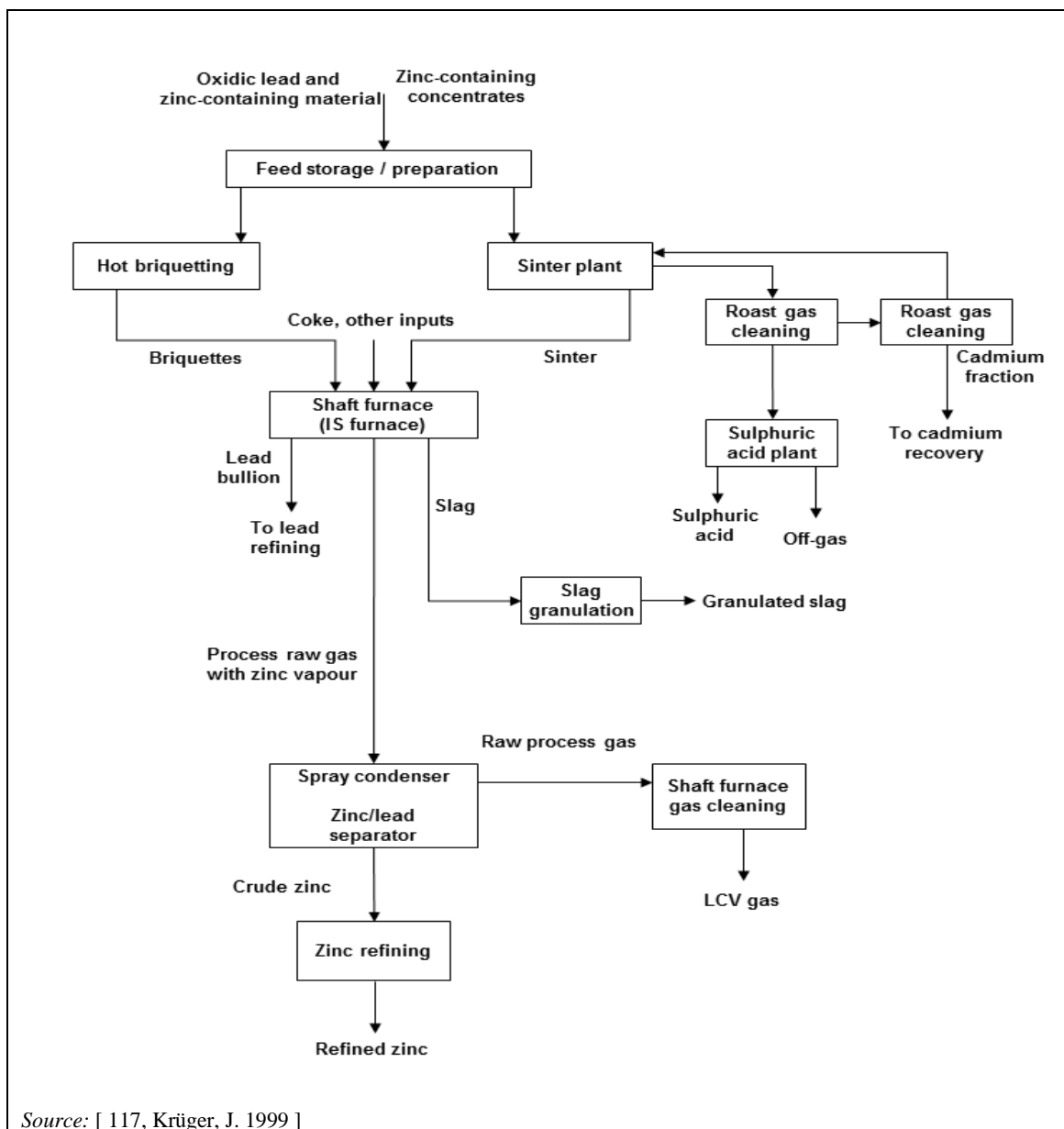

Figure 6.1: Diagram of a typical Imperial Smelting Process

The sinter plant in the ISF Process includes the following:

- Primary and secondary raw material storage areas. These raw materials are delivered to the next steps of the process by belt conveyors equipped with weighing devices and vibratory feeders.
- Burden preparation unit. The prepared charge is conveyed from storage bins to degree mixers by belt conveyors. The charge is composed of raw materials and recycled sinter, and fluxing agents (limestone and sand) are additionally directed into this process.
- Sintering machine.
- Sinter crushing unit.

The objectives of the sinter plant are the oxidation of metal sulphides and the decomposition of metal sulphates contained in the charge and the generation of a sintered product of appropriately high mechanical strength which, as a result of its further mechanical processing (crushing, screening), turns into a charge suitable for treatment in the ISF.

The process gases generated in the sintering process contain sulphur dioxide. These gases are captured and directed to the sulphur dioxide recovery systems. Depending on the raw materials, the gases contain varying volumes of sulphur dioxide and are treated in different ways.

- If sulphide or sulphidic/oxidic raw materials are processed, an average SO₂ content of 5 % (7 % maximum) in the flue-gases is obtained and these gases are used in the sulphuric acid plant.
- If oxide-type raw materials are processed, the SO₂ content in the flue-gases is too low (0.3–0.5 wt-%) for it to be used in the sulphuric acid plant, and therefore the gases need to be treated in a different way (e.g. wet limestone desulphurisation plant).

Charge materials prepared in the sinter plant are fed in appropriate proportions to the furnace's loading containers and charged through the gas-tight double bell lock system. The temperature of the sinter is usually close to ambient temperature, while the charged coke is heated up to approximately 600–650 °C.

Within the ISF itself, the following three zones can be distinguished.

- The melting and reduction zone is located in the lower part of the furnace. The main chemical processes in this zone include: coke burning and zinc, lead and iron oxides reduction. Other reactions between slag-forming components also take place in the same zone. The most important physical process in the melting and reduction zone is the smelting of the slag-forming phase. Hot air, sinter, coke and zinc oxide generated as a result of the reoxidation process in the equilibrium and charge-heating zones situated in the upper part of the furnace constitute the substrates in the melting and reduction zone, while the products of the processes taking place in that zone include liquid lead and slag tapped from the furnace into the sedimentation tank, as well as the stream of gases with carbon monoxide, carbon dioxide, nitrogen and zinc vapour. This gas stream flows into the equilibrium zone above. The lead layer from the sedimentation tank is directed into the casthouse and then to the lead refinery, while the slag is granulated with water.
- The equilibrium zone occupies the largest part of the furnace volume. This zone is characterised by the charge and the gas stream being approximately the same temperature. The main reaction taking place in the equilibrium zone is the Boudouard reaction:

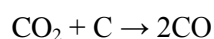

The endothermic character of this reaction and the heat exchange between the charge stream that goes down the furnace and the gas stream flowing in the opposite direction result in the temperature changing from around 1250 °C in the lower part of the zone to approximately 1000 °C in the upper part. The reactions in the equilibrium zone result in the increase of the carbon monoxide concentration in the gas stream, while CO₂ and Zn concentrations decrease.

- The charge-heating zone is located in the upper part of the furnace. The charge is heated by gases flowing out of the equilibrium zone and by the zinc vapour reoxidation process.

The stream of process gases leaving the charge-heating zone is introduced into the condenser through the intermediate chamber. The condenser chamber, with a controlled liquid lead level, is divided into three sections. In each of the condenser sections, mixers with specifically shaped rotors spread the liquid lead over the condenser space. As a result of the contact of the shaft furnace gas stream (temperature of 1000 °C) with liquid lead (approximately 600 °C), intensive heat exchange and dissolving of zinc vapour in lead takes place. In the homogeneous zinc-lead alloy, which is produced in the condenser, coexistence of liquid phases - rich in zinc and rich in lead - is achieved. The upper, zinc-rich layer is separated and goes through the flux agent tank, through the liquation tank and then to the zinc tank. The lower, lead-rich layer is sent back to the condenser through the return trough. In this way, a constant flow of lead (Pb-Zn alloy, in fact) is maintained through the condenser. In the liquation tank excess lead is separated from zinc, and the Imperial Smelting Process (ISP) zinc is collected in the zinc tank and is then

directed to the zinc rectification process. The carbon-monoxide-containing process gases generated in the shaft furnace are purified and then used in Cowper stoves, for coke heating, and are burnt in the smelter's boiler house.

Zinc produced in the ISF may contain varying amounts of cadmium, lead, copper, arsenic, antimony and iron and the process uses a refining stage.

Zinc from the ISF is refined by reflux distillation in columns that contain a large number of refractory trays (New Jersey distillation). The lower ends of the columns are heated externally by natural gas. The upper ends are not heated and run cool enough to reflux the higher boiling point metals before vapours pass to a condenser [11, Hatch Associates Ltd 1993], [99, Hähre, S. 1998]. The New Jersey distillation column is also used for secondary zinc materials [117, Krüger, J. 1999].

Distillation proceeds in two stages:

- first stage: the separation of zinc and cadmium from lead;
- second stage: the separation of cadmium from zinc.

In the first stage, molten zinc is fed into a column where all the cadmium and a high proportion of the zinc are distilled. The mixture is condensed and fed directly to a second column to start the second stage. This column is operated at a slightly lower temperature to distil mainly cadmium, which is condensed as a zinc-cadmium alloy as shown in Figure 6.2. The alloy is transferred to a cadmium refinery. The metal run-off from the bottom of the second column is special high-grade (SHG) zinc of 99.995 % purity [117, Krüger, J. 1999]

The run-off metal from the first stage is zinc with lead, tin, arsenic, iron, antimony and copper impurities. This alloy is cooled to separate lead, which is recycled to the spray condenser downstream ISF, and dross, an intermetallic compound of iron, zinc and arsenic, which is recycled to the ISF itself.

The zinc is then treated with sodium to remove residual arsenic and antimony as sodium arsenides and antimonides, which are also recycled to the ISF. The zinc produced in this way is of a lower grade called good ordinary brand (GOB), but free of cadmium, and is used mainly for galvanising.

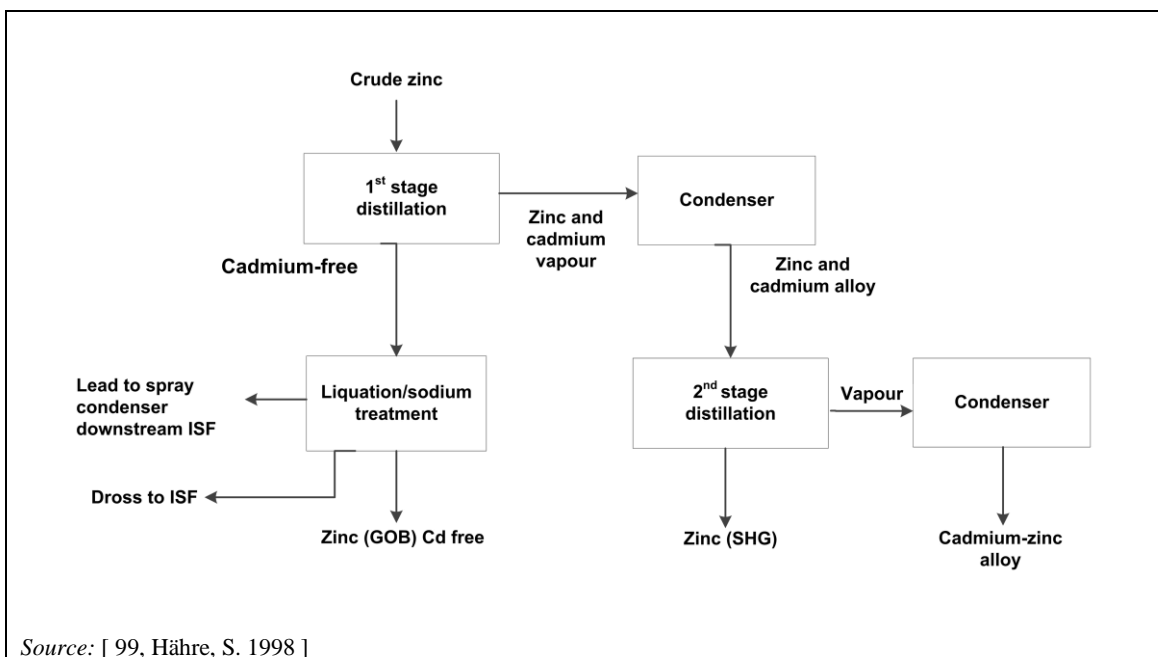

Figure 6.2: Diagram of zinc-cadmium distillation

6.1.1.3 The hydrometallurgical route

The hydrometallurgical route is used for extracting zinc from zinc sulphide (blende), oxide, carbonate or silicate concentrates and also for some secondary materials such as Waelz oxide. This route accounts for about 90 % of the total world zinc output [98, Lijftogt, J.A. et al 1998] [99, Hähre, S. 1998]. The majority of the EU production facilities apply the hydrometallurgical route, which is also called RLE (roast-leach-electrowin) with a total production capacity of 2.1 million tonnes in 2007 [363, Brown et al. 2013]. RLE is a continuous process. A simplified diagram of the process can be found in Figure 6.3.

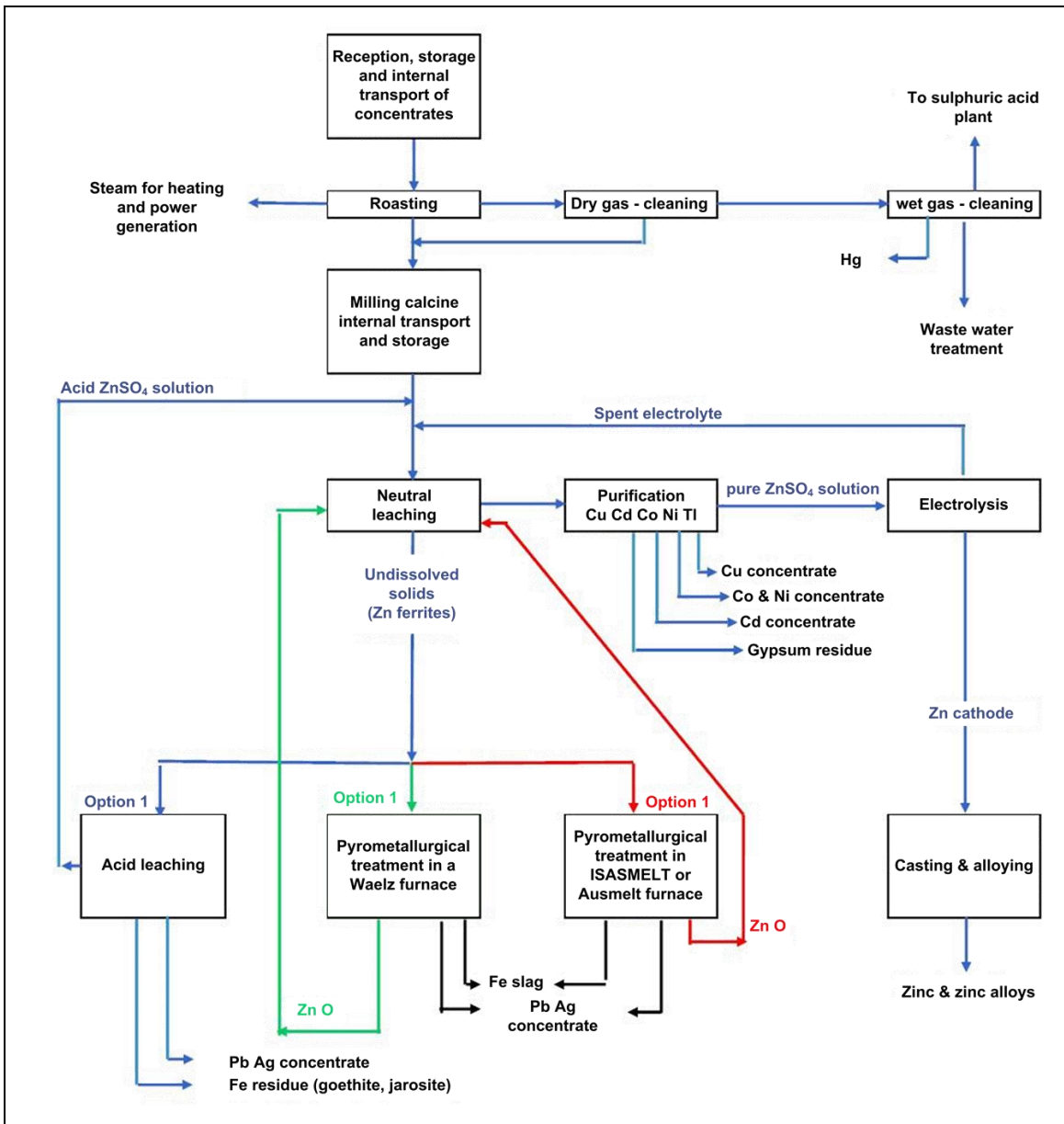

Figure 6.3: Simplified diagram of the hydrometallurgical route

Feed blends can be prepared from dosing bin systems using belt weighers or loss-in-weight systems. Final mixing and homogenisation can take place in mixers, or in the conveying and metering systems. Enclosed conveyors or pneumatic transfer systems are used for dusty materials. Concentrates are mixed in order to produce a fairly constant feed. Therefore, the general practice is sampling and analysis to categorise the concentrates and to store individual concentrates separately so that an optimum blend can be prepared before sintering or roasting. Blending rules for roasting exist to obtain a good fluidised bed.

After the preparation of the feed, the main process steps are:

- roasting;
- calcine processing;
- leaching;
- purification;
- electrolysis.

6.1.1.3.1 Roasting

Zinc sulphide (sphalerite) concentrates are continuously fed by means of rotary table feeders and slinger belts and roasted in closed fluidised bed roasters to produce zinc oxide and sulphur dioxide. Up to 25 % of secondary zinc oxide material such as dehalogenated Waelz oxide may be added as a coolant to the roaster feed material.

Roasting air or oxygen-enriched air is blown through a nozzle grate into the roasting bed. It serves both as a carrier medium for the fluidised bed and as a source of oxygen for the predominant reaction. Roasting of sulphidic material requires no additional fuel, since it is an exothermic process:



Part of the surplus reaction heat is absorbed by cooling coils installed in the fluidised bed in the form of evaporator heating surfaces connected to the forced circulation system of the waste heat boiler (see Figure 6.4). Cooling elements incorporated into the fluidised bed maintain the roasting temperature between 900 °C and 1 000 °C.

The hot off-gas from the fluidised bed furnace contains ~ 10 % SO₂. Gases are cooled in the waste heat boiler and the heat is recovered as steam. Part of the carry-over fine calcine is separated from the gas stream in the waste heat boiler. Cooled roaster gases leaving the boiler flow into cyclones followed by hot electrostatic precipitators for dust removal, as shown in Figure 6.4.

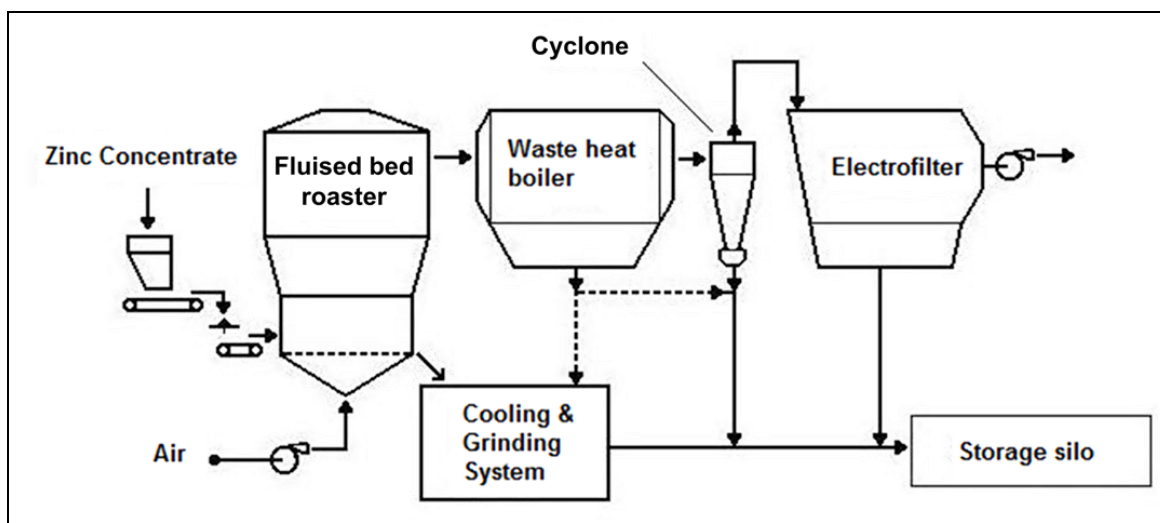

Figure 6.4: Roasting gas cleaning stage 1: dry gas cleaning (cyclone optional)

The gas from the hot ESP enters the wet gas cleaning plant, which consists of a quench tower, a high-efficiency scrubber, wet ESPs and mercury removal towers, as shown in Figure 6.5. The wet gas cleaning plant aims to guarantee sulphuric acid production with low levels of dust and impurities such as As, Sb, Se, F, Cl and Hg.

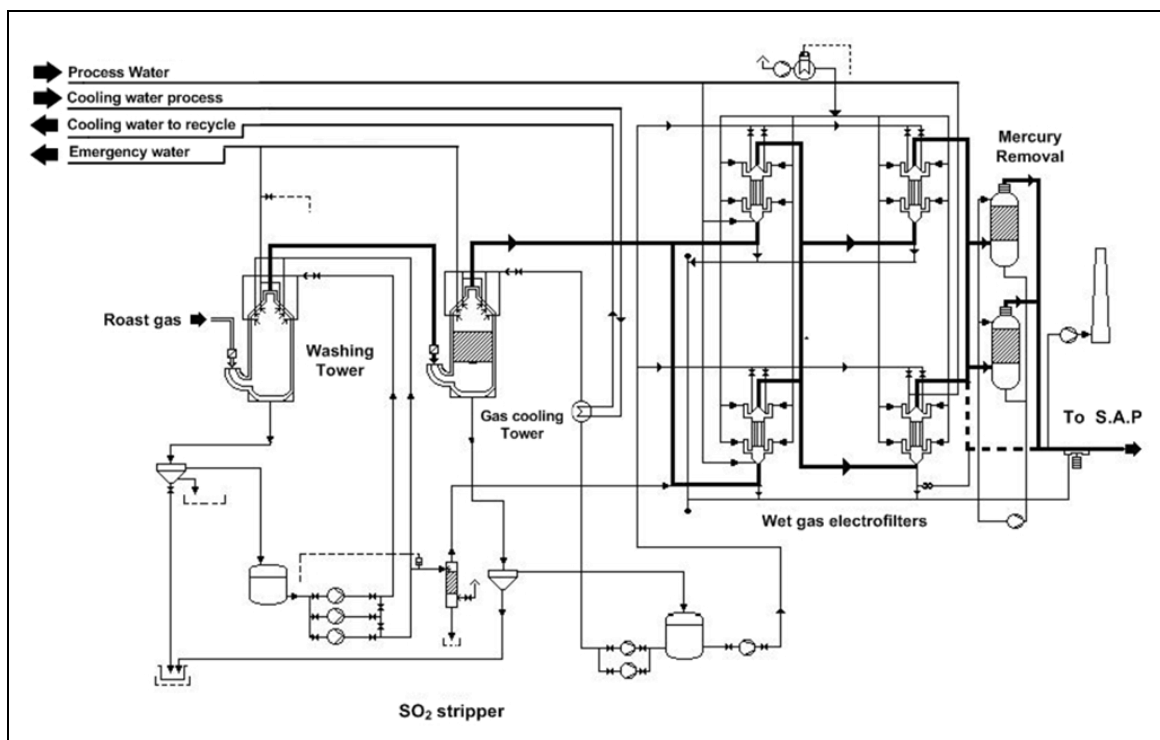

Figure 6.5: Roasting gas cleaning stage 2: wet gas cleaning

The captured sludges are filtered, washed and partly recycled (when possible), and partly sent to regulated hazardous landfills.

The sulphur dioxide is then converted to sulphuric acid in a conventional recovery system [11, Hatch Associates Ltd 1993] [98, Lijftogt, J.A. et al 1998], [99, Hähre, S. 1998], [117, Krüger, J. 1999]. The off-gas from the H₂SO₄ conversion is led to candle filters or scrubbers to minimise the remaining acid mist, in the form of SO₃.

The gas-cleaning train waste water is treated at the waste water treatment plant.

It is also possible to compress SO₂ gas to liquid SO₂. This is applied by one smaller roasting unit in Spain.

6.1.1.3.2 Calcine processing

The zinc oxide (calcine) is continuously collected from the furnace, the waste heat boiler, the cyclones (optional) and the ESPs, and cooled down in a rotary or fluidised bed cooler. In the rotary (sectional) cooler, the heat exchange is carried out by contacting the calcine with the water-cooled surface of the cooler, while in the fluidised bed cooler the heat is recovered by contacting the calcine with both fluidising gas and water-cooled surfaces. The calcine to be cooled in a rotary cooler enters the inlet cylinder of the cooler by means of a loading device (e.g. skids, endless screw). A sectional cooler essentially consists of a turning rotor which is mostly chain-driven. At the ends of the rotor are stiff cases for calcine feed and the outlet. Depending on the size of the cooler, the rotor is pivoted either at the ends of its own shaft or is supported on running treads, as is typical for rotary drums. The interior of the rotor consists of several section-shaped chambers which are arranged like cake slices around a central hollow shaft. This arrangement is completely surrounded by a water shell. The section-shaped chambers contain conveyor elements (shovels, chains or similar; fluidised bed coolers have also been reported).

The off-gas from the cooler is led to the waste heat boiler or the roaster line.

The dusty calcined material, entrained by the roaster gas, is cooled in the boiler, collected by a Redler conveyor and discharged, together with the calcine coming from the rotary or fluidised bed cooler, in a ball mill that will grind it to the desired grain size (approximately 70 % below 50 μm).

To prevent dust emissions in the calcine-handling system, all the equipment is maintained under a negative pressure, generated by an aspirating ventilator, and a bag filter is usually applied to recover dust.

Prior to being sent to the leaching plant, the calcine is temporarily stored in a silo. From the silo, the calcine is sent to the leaching section by means of pneumatic or hydraulic transportation.

6.1.1.3.3 Leaching

Leaching of the calcine is carried out in a number of successive stages using a gradually increasing strength of hot sulphuric acid. The initial stages (neutral leaching) are operated at low acidity and temperature (typically pH 4–4.5 and 50 °C) and do not yet dissolve significant amounts of iron. The leaching process is carried out in a variety of reactors using open tanks, sealed vessels and pressure vessels or a combination of them [98, Lijftogt, J.A. et al 1998], [99, Hähre, S. 1998], (see Figure 6.6).

When using secondary feed from Waelz treatment of EAF dust, the Waelz oxide needs to be washed beforehand to remove chlorides. In most cases, this is done by companies that treat EAF dust in the Waelz furnace.

The leach liquor is supplemented by the leach liquor from the iron precipitate removal step. If only small amounts of secondary feed are used (< 10 % Waelz oxide), the secondary raw material can be added after the roasting step.

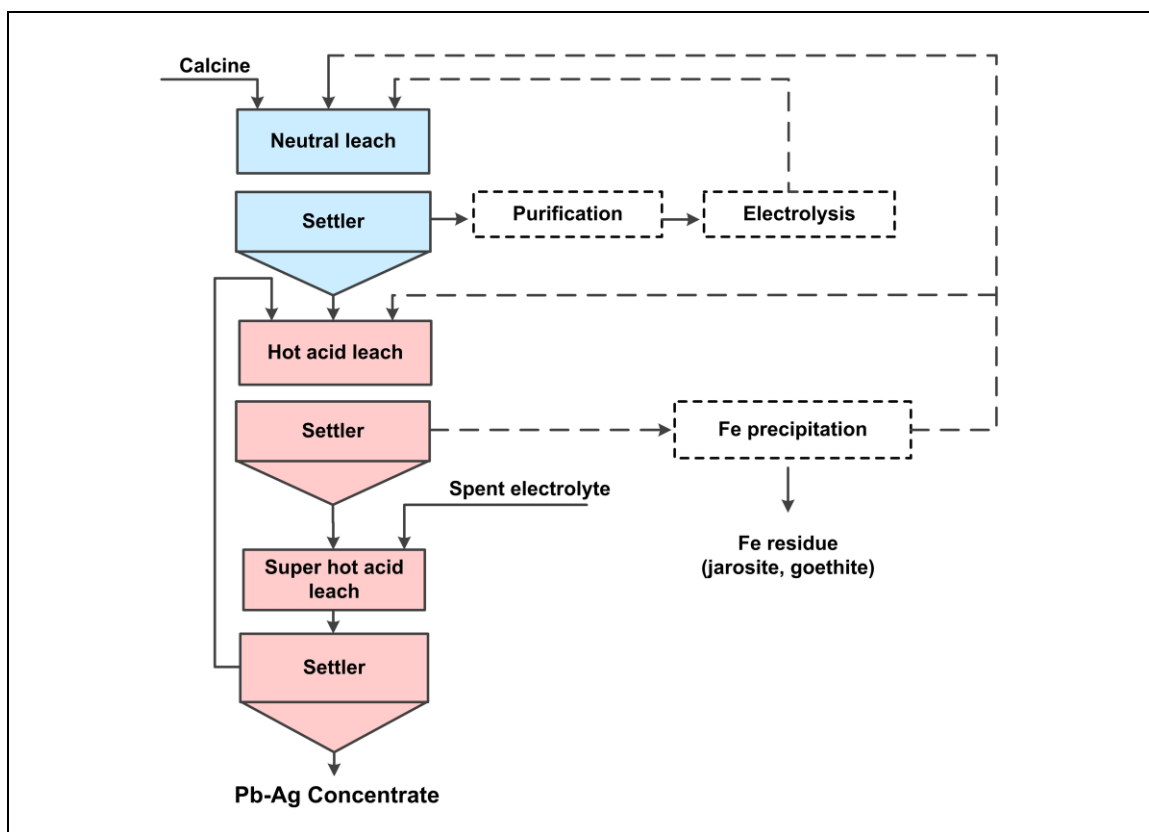

Figure 6.6: Simplified flowsheet of the leaching process

Depending on whether zinc ferrites are present in the calcine or not, and after the first leaching stages (neutral leach coupled with a weak acid leach), the extraction yield of zinc from the feed into the leaching liquor can vary between ~ 70 % and 95 %. Other metals like Cu, Cd, Co and Ni are also partly extracted. Therefore, the leaching liquor needs to pass purification steps before being fed to the cell house.

The remaining ~ 5–30 % of the zinc is trapped in the leaching residue, together with insoluble iron and lead compounds and other gangue material.

In addition to the stirred tank, leaching also involves solid-liquid separation which entails the use of thickeners/clarifiers and in some instances also filters and centrifuges. Normally, vacuum or membrane filters are used for the separation of leaching products and/or iron residues for final disposal. Several options for further treatment of this residue are available.

Direct leaching

Direct leaching is a process in which ZnS ores are leached without prior oxidation in a roasting furnace. To obtain a high recovery yield of zinc, the leaching is done at higher temperatures and with injection of oxygen. There are variants that are run under atmospheric pressure, as well as others under pressurised operation in autoclaves. The latter require more expensive equipment and more safety measures but the process is faster.

The atmospheric direct leach process has some advantages over the traditional process:

- the process can be economically designed for smaller capacities;
- low investment cost;
- it can be applied for an intermediate capacity increase without the high investment in a roaster and sulphuric acid plant;
- reduced maintenance costs;
- easy process control (acidity and iron control);
- very flexible process, which allows various methods for iron removal;
- high zinc recovery;
- low power consumption: little or no heating needed;
- no explosion risk;
- no SO₂ emission or molten sulphur.

On the other hand, there are also disadvantages:

- no exploitation of the sulphur or recovery of the exothermal reaction heat from the roasting;
- generation of sulphur residue that needs to be disposed of in an appropriate pond.

Direct leach processes are always integrated in a traditional RLE process and only a fraction of the ores are directly leached.

A few plants are known to leach a part of the concentrate directly without calcination. Atmospheric direct leach processes are installed at the new Boliden plants in Kokkola (since 1998) and Odda (since 2004), and Zhuzhou in China (since 2010). A pressurised direct leach process was installed at Korea Zinc, Onsan (since 1994). At the Korea Zinc plant, the iron is left in solution during the leaching and is then precipitated in a separate step as goethite, whereas at Kokkola and Odda, the iron is precipitated as jarosite simultaneously with the leaching of the sulphides. At Zhuzhou, iron is precipitated as goethite.

The concentrate together with the process solution and acid from the electrolysis is fed to the reactors where the leaching takes place by sparging oxygen into the slurry. The rest of the dissolved iron in the solution from the conversion and the iron dissolved from the concentrate are precipitated as jarosite. The net reaction for direct leaching and simultaneous jarosite precipitation can be written as:

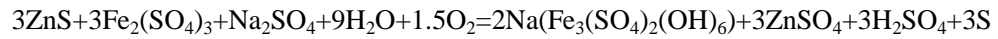

A sulphur concentrate is separated from the slurry by flotation and stored separately from the jarosite residue. This sulphur concentrate contains a significant amount of impurities and is disposed of to land and this makes the direct leaching process a very site-specific issue. The equipment used in the process is more complicated than that conventionally used in zinc hydrometallurgy.

A flowsheet of the leaching process with an integrated atmospheric direct leach is shown in Figure 6.7.

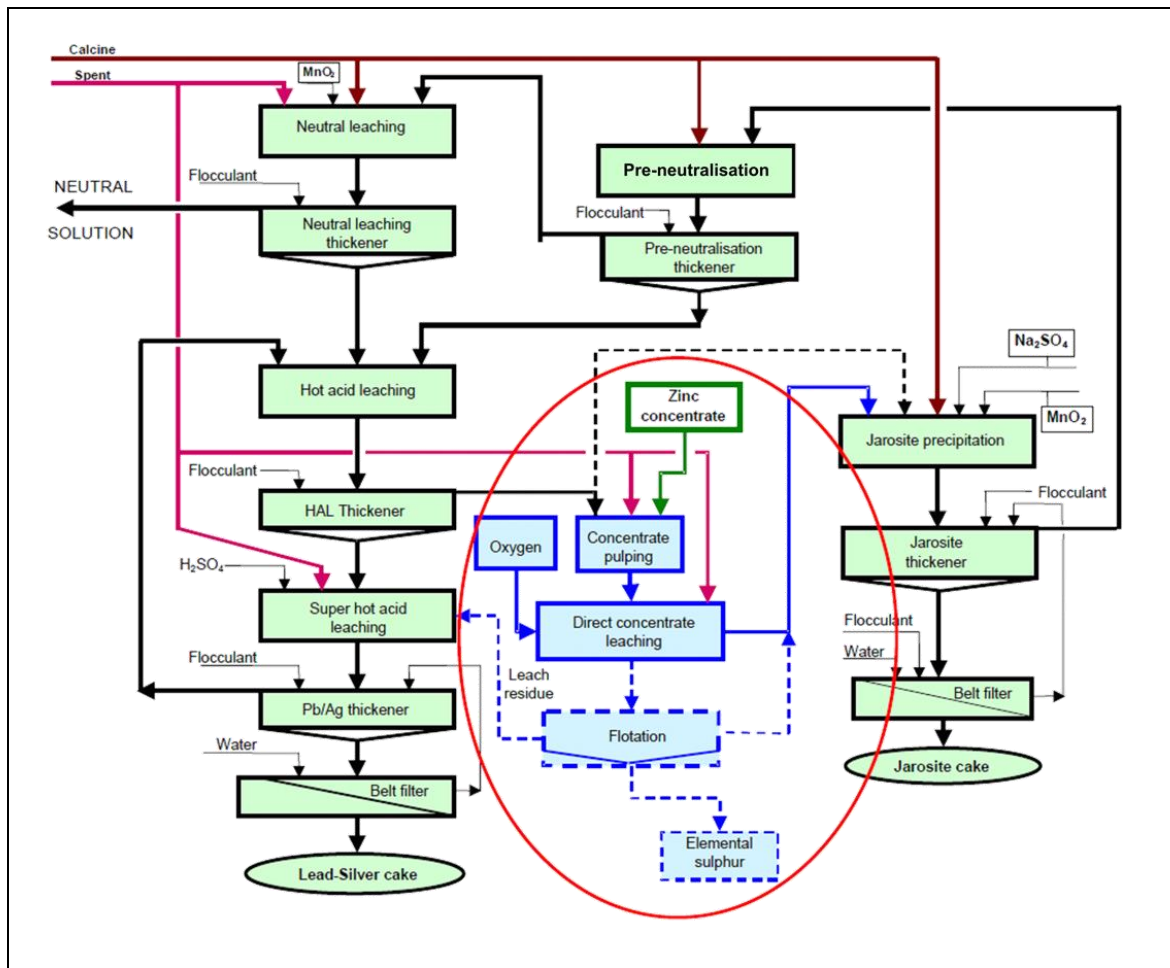

Figure 6.7: Flowsheet of the leaching process with an integrated atmospheric direct leach to increase the plant capacity

A further description of the process is given in [283, Lahtinen et al. 2004]

6.1.1.3.4 Purification

The elimination of impurities from the electrolyte, prior to electrolysis, is key for the quality of the zinc deposit. Purification of the zinc-bearing solution can be carried out in a number of ways using zinc powder (to reduce and precipitate metallic impurities) or by solvent extraction (to extract a pure ZnSO_4 solution). The processes used are dependent on the concentrations of the various metals contained in the raw materials and vary accordingly.

6.1.1.3.4.1 Purification using chemicals

The basic chemical purification processes involve the use of zinc powder to precipitate impurities such as Cu, Cd, Ni, Co and Tl. Being more noble than zinc, these impurities are reduced and form a metallic precipitate upon addition of fine zinc powder to the solution, following the generic electrochemical reaction:



Copper and cadmium can be precipitated easily with zinc powder. The precipitation kinetics of cobalt and nickel, however, are too low for an industrial process, and necessitate uneconomical amounts of zinc powder. The use of an additional precipitating agent for the removal of cobalt and nickel is therefore a necessity; two common variants of zinc purification are the so-called arsenic (As) and antimony (Sb) processes, where As^{3+} and Sb^{3+} ions are used respectively in addition to zinc powder. Using arsenic as an example, the following reaction equation occurs:

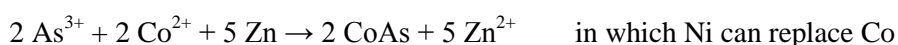

The zinc powder used in the purification process is typically produced on site using cathodic zinc from the electrolytic process. The consumption of zinc powder varies among the plants and processes and, as a range, 1.5–6 % of cathodes will be used for purification. Zinc powder consumption is affected not only by the process route, but also by the concentration/amounts of impurities in the solution treated. Although the different plants may have different process set-ups and layouts, the basic chemical reactions are the same.

The arsenic-based process uses As_2O_3 to reach the desired concentration of arsenic in the solution. The optimal concentration varies between a few mg/l of arsenic up to 150 mg/l according to a survey among zinc plants around the world in 2002 (carried out by Boliden Odda). The arsenic trioxide stock solution can be prepared using caustic soda, for example, or hot water. A simplified flowsheet from an existing plant is provided in Figure 6.8 as an example of arsenic-based purification. It should be noted that other variants of the arsenic-based process exist, for example with an additional copper removal stage beforehand.

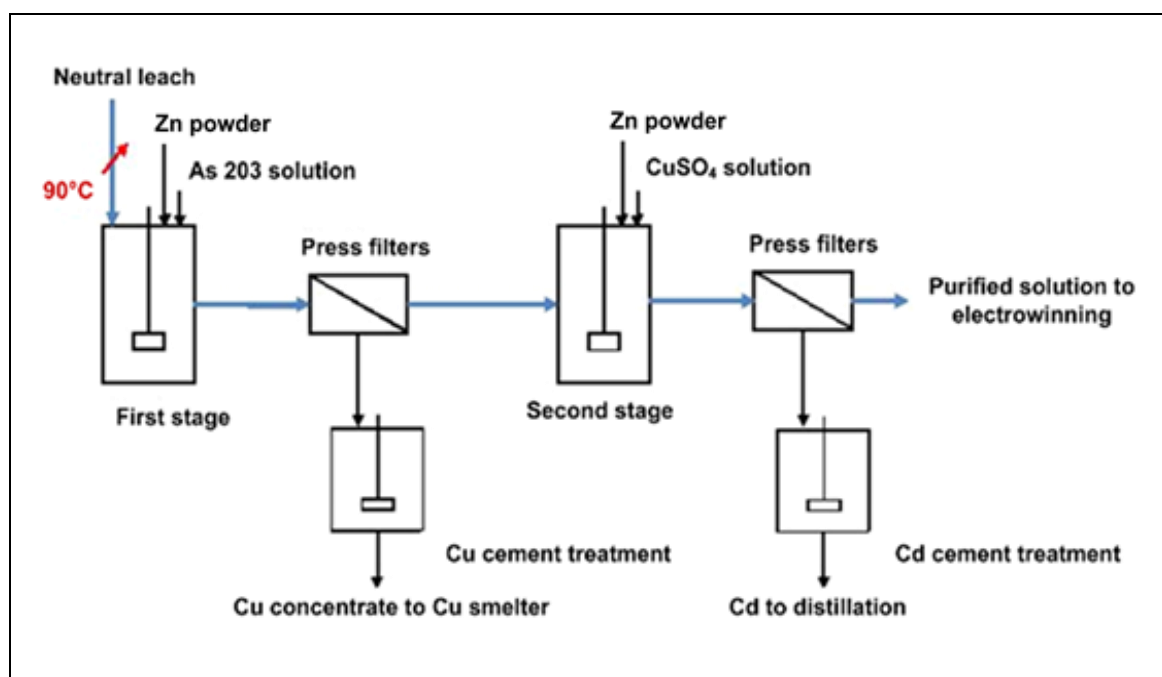

Figure 6.8: Example flowsheet for an As-based purification process for removal of Co and Ni

To maintain a good, arsenic-free workplace, special equipment and care are necessary when making the arsenic stock solution. As_2O_3 is normally shipped in metal barrels, and the emptying and subsequent handling and disposal of these barrels must be carefully considered. A fully enclosed drum handling unit, connected to a scrubber system, can for example be used to control dust emissions. Empty steel drums require thorough cleaning before being disposed of as scrap.

Due to the strong reducing environment in the reactions involved, side reactions do occur, and it is known that smaller amounts of AsH_3 (arsane gas) can be produced and leave the reactors. To avoid emitting AsH_3 through the stack/ventilation air, it is common to oxidise the AsH_3 (gas) back to As^{3+} with the aid of KMnO_4 or sulphuric acid scrubbing. The arsenic will then be captured and reintroduced into the process liquid or specially treated.

Arsenic then exits the process as a component of the copper by-product, which is sold to a copper smelter for recovery of metals. Alternatively, it can be leached out of the by-product using caustic soda, and stabilised in the leaching circuit for disposal to landfill as a component of the iron residue.

In Europe, Plant A applies the arsenic-based process.

The antimony-based processes normally use antimony tartrate for the addition of antimony to the process solution. Concentrations are normally within a few milligrams of Sb^{3+} per litre. In Plant D, antimony additions vary between 3 mg/l and 4 mg/l under prevailing conditions.

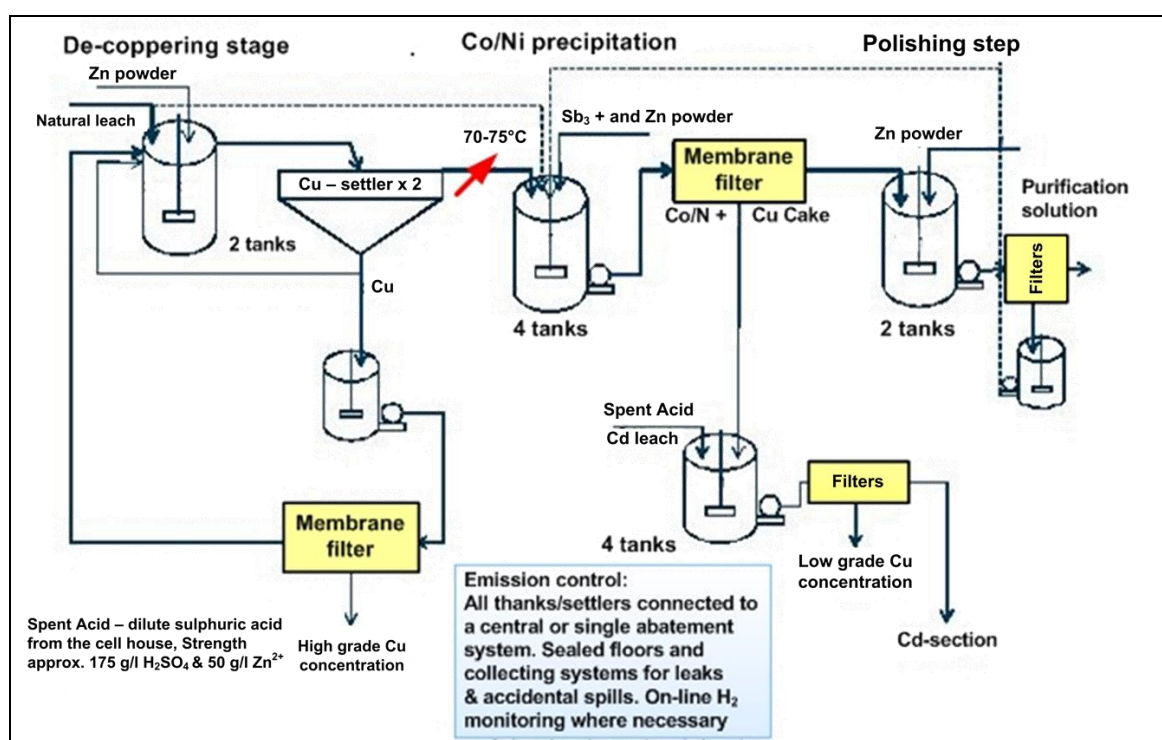

Figure 6.9: Flowsheet of the Sb-based purification process at Plant D

At Plant D, the stock/dosing solution is made to a strength of approximately 4 g/l Sb^{3+} (in water) in a semi-automatic barrel-emptying device, which uses water to empty/wash the 25-kg steel barrel's content into a storage container/mixer. The small barrel has an internal plastic bag containing the antimony tartrate. The metal in the emptied barrel goes to the municipal recycling system. The antimony emission from this process is not considered significant.

In Europe, Plants B, C, D, E and F apply the antimony-based process.

Both in the arsenic and antimony processes, small amounts of hydrogen gas (H_2) will also be formed in the reactors due to the reducing environment which in turn must be kept below the LEL (lower explosion limit) to avoid the risk of explosion/fire. This leads naturally to the need for forced ventilation of the reactors to always maintain a low level of H_2 in the off-gas. Hydrogen levels are monitored continuously by on-line samplers.

Due to the very reducing nature of the purification steps (zinc powder additions), a combination of unsolicited conditions may lead to the formation of hydrogen. Accordingly, arsane or stibane occurrence is permanently monitored. However, nowadays most plants have improved the process conditions to avoid hazardous conditions with arsane or stibane.

Due to the rising amount of secondary feed material, the increasing concentration of calcium in the leaching circuit is solved by using gypsum removal from the leach liquor. A separate and occasional treatment of a partial flow of the liquor (bleed) can be conducted to remove magnesium, chloride and fluorides. It is known that smaller amounts of AsH_3 (arsane gas) can be produced. The continuous removal of cobalt is more effective at minimising emissions of arsane than batch removal. Collection and treatment of the released gases depends on the overall engineering (open-air or enclosed building operations can be used) but scrubbing the gases from the reactors using an oxidising solution for arsane removal is reported to be most effective [136, Fugleberg, S. 1999].

6.1.1.3.4.2 Purification using solvent extraction

The electrolyte can also be concentrated and purified using a solvent extraction system such as the Modified Zincex™ Process (see Annex 13.1.7.4). In this process, zinc is extracted selectively into a solvent such as di(2-ethylhexyl) phosphoric acid in a specific kerosene to purify and upgrade the pregnant leach solution (PLS). The use of solvent extraction means that other metals are not carried into the electrolyte. Calcium, magnesium and halides, which would interfere with the electrowinning stage, are also rejected. Zinc is then stripped from the organic phase using spent electrolyte from zinc electrowinning to give a pure electrolyte [327, Gnoinski et al. 2008]. Although this process is mainly used to treat secondary zinc materials, such as Waelz oxide, it can also be used to concentrate weak solutions of zinc such as those produced by leaching oxidic ores and to purify zinc solutions derived from the recycling of zinc/manganese batteries. The main stages included in the solvent extraction (SX) unit are extraction, washing, stripping, and organic regeneration, as shown in Figure 6.10.

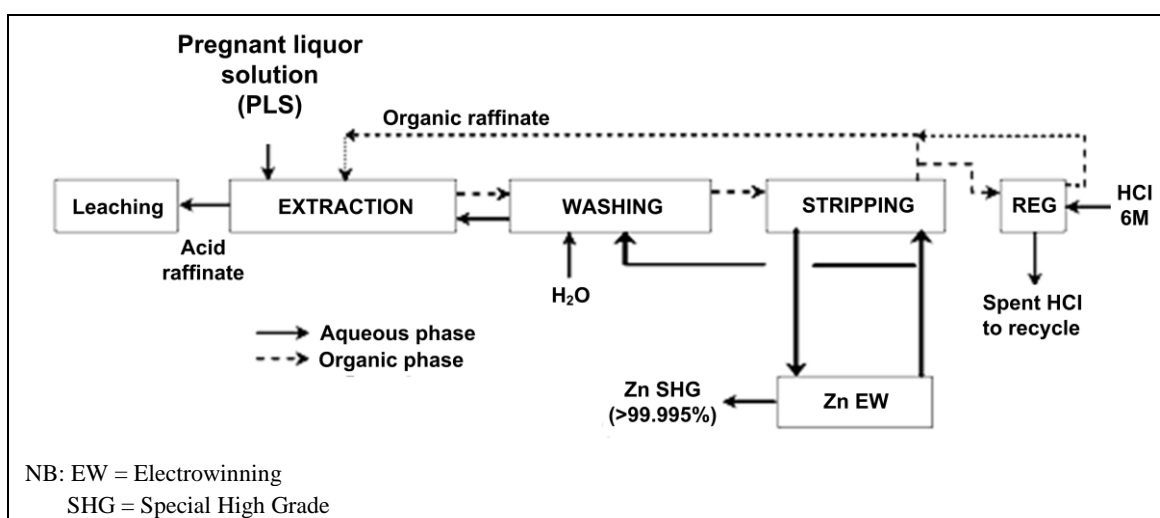

Figure 6.10: Simplified flowsheet of the Modified Zincex™ Process SX

The aqueous acid zinc raffinate leaving the extraction stage is recycled to the leaching section after the entrained organics are removed. A small proportion is sent to the bleed treatment section to balance the components of the circuit.

The typical flow rate is 50 m³/h per tonne of zinc produced. Table 6.1 shows the reagents and utilities consumption for the SX process.

Table 6.1: Main reagent and utilities consumption in the Modified Zincex™ Process

Component	Unit	Consumption per tonne of zinc produced
NaCl	kg	16
Active charcoal	kg	0.9
D ₂ EHPA	kg	0.7
Kerosene	kg	8
Demineralised water	m ³	3
Electricity (excl. electrolysis)	kWh	115
<i>Source: [399, IZA 2012]</i>		

The SX technology claims to:

- reduce the production of solid residues and liquid effluents;
- save energy in the electrolytic process because lower cell voltages can be used with the purer electrolyte produced by the SX processes;
- need a lower zinc electrowinning capacity for the same level of production as the very pure electrolyte needs no purification with zinc dust.

At the time of writing (2014), only one plant, located in Namibia, is using this process with primary materials. This plant deals with a special concentrate which is very high in manganese, making it impossible to treat in an existing zinc refinery. In this particular case, the SX process provided a solution to exploit this special low-grade zinc oxide deposit.

6.1.1.3.5 Electrolysis

The purified solution from either cementation or solvent extraction processes passes to a cell house where zinc is electrowon using lead anodes and aluminium cathodes. Zinc is deposited at the cathodes and oxygen is formed at the anodes, where sulphuric acid is also generated and is recycled to the leaching stage. Acid mist is formed during this process and various coverings or the preservation of a foam layer can be used on the cells to minimise this. Cell room ventilation air can be demisted and the acid mist recovered. Heat is produced during electrolysis and this is removed in a cooling circuit, which is designed to optimise the water balance of the process but may be a further source of mists.

The zinc produced is deposited on the aluminium cathodes and is removed by stripping the cathodes usually every day. For melting, low-frequency induction furnaces are used. [117, Krüger, J. 1999]. A small part of the zinc produced is made into zinc powder or dust for the purification stages. This can be produced by air, water or centrifugal atomisation of a stream of molten zinc or by condensing zinc vapour in an inert atmosphere.

6.1.1.3.6 Neutral leach residue treatment and disposal of iron residues

One of the main issues in the hydrometallurgical process route is the disposal or further use or treatment of the precipitated iron. Special containment sites are used for safe disposal at the moment but pressure on disposal options is increasing. This factor is discussed later and the options are assessed. Several approaches are being developed to help avoid these residues or to help find suitable uses for them. The different options are shown in Figure 6.13.

6.1.1.3.6.1 Pyrometallurgical treatment of neutral leach residue

Leaching may be stopped after the neutral leach because of a low iron concentration or when local conditions trigger the choice. The leach residue can be sent to an ISF or any other high-temperature smelting furnace and added there to the process feed. Zinc, lead, silver and other valuable metals are recovered as metals, and sulphur as H_2SO_4 (provided a sulphuric acid plant is linked to the furnace gas stream).

The leach residue can also be processed in a Waelz kiln or zinc-fuming furnace but SO_2 absorption is necessary in such a case. Zinc and lead are recovered as oxides and sulphates, and the slag in this case may be treated further by flotation to recover silver and copper. Due to the closure of nearly all European ISF plants (Germany, France and the UK) and the limited availability of European Waelz plants with a SO_2 adsorption step (Poland and Bulgaria), there is a limited capacity for pyrometallurgical treatment of the neutral leach residue. The neutral leach residue is treated hydrometallurgically in most plants.

6.1.1.3.6.2 Hydrometallurgical treatment of neutral leach residue

The main target of the hydrometallurgical treatment is the leaching of zinc ferrite, which occurs efficiently only at high acidity and temperatures above 90 °C. This treatment of the leach residue implies a countercurrent sequence of steps with increasing acidity levels and temperature.

Slurry from the final leaching stage is settled and the overflow solution is countercurrently taken back through the former process steps. The solid in the underflow is filtered and washed on a filter. The filter cake is disposed of and the filtrate is recycled to the process. Different flowsheets are used depending on factors such as the choice of iron removal process and the integrated impurity recovery processes available.

For example, more or less extensive treatment of the leach residue is carried out by further leaching or physical separation techniques before it is disposed of [117, Krüger, J. 1999]. This is reflected in the recovery rates and composition of possible lead or lead-silver by-products.

In addition to zinc, other metals are also dissolved during this leaching process. Iron is the major impurity and is precipitated in three basic forms; jarosite, goethite or haematite. The form of these precipitates is used to give the processes their names [98, Lijftogt, J.A. et al 1998] [99, Hähre, S. 1998].

The different precipitation processes for iron residues are as follows:

- **Jarosite**, using ammonia or another monovalent cation and zinc calcine for neutralisation. Up to three stages are used depending on whether lead-silver recovery is undertaken. A single-stage process known as the conversion process is also used.
- **Goethite**, using zinc sulphide for pre-reduction, oxygen for reoxidation and zinc calcine for neutralisation.

- **Haematite**, using sulphur dioxide or zinc sulphide for pre-reduction and an autoclave with oxygen for precipitation. In this case, a sulphur residue is produced as well as an iron residue.

The main differences in the iron precipitates are their volume and ease of filterability. There are also significant differences in process capital and operating costs [117, Krüger, J. 1999]. The balance of these with the disposal costs of the residue may be influenced by non-process-related costs. The haematite process was thought to be very attractive as the residue volume was lower and haematite was a potential raw material for iron. However, the process has not proved to be viable and the haematite was not acceptable to the iron and steel industry.

It has also been reported [136, Fugleberg, S. 1999] that the jarosite process is capable of high levels of zinc recovery even with concentrates that contain 10 % iron. Similar recovery levels with the goethite process rely on a low iron content in the calcine fraction (or ZnO) that is used for the precipitation in the hydrolysis stage.

The conventional goethite and jarosite iron removal processes are outlined in Figure 6.11 and Figure 6.12.

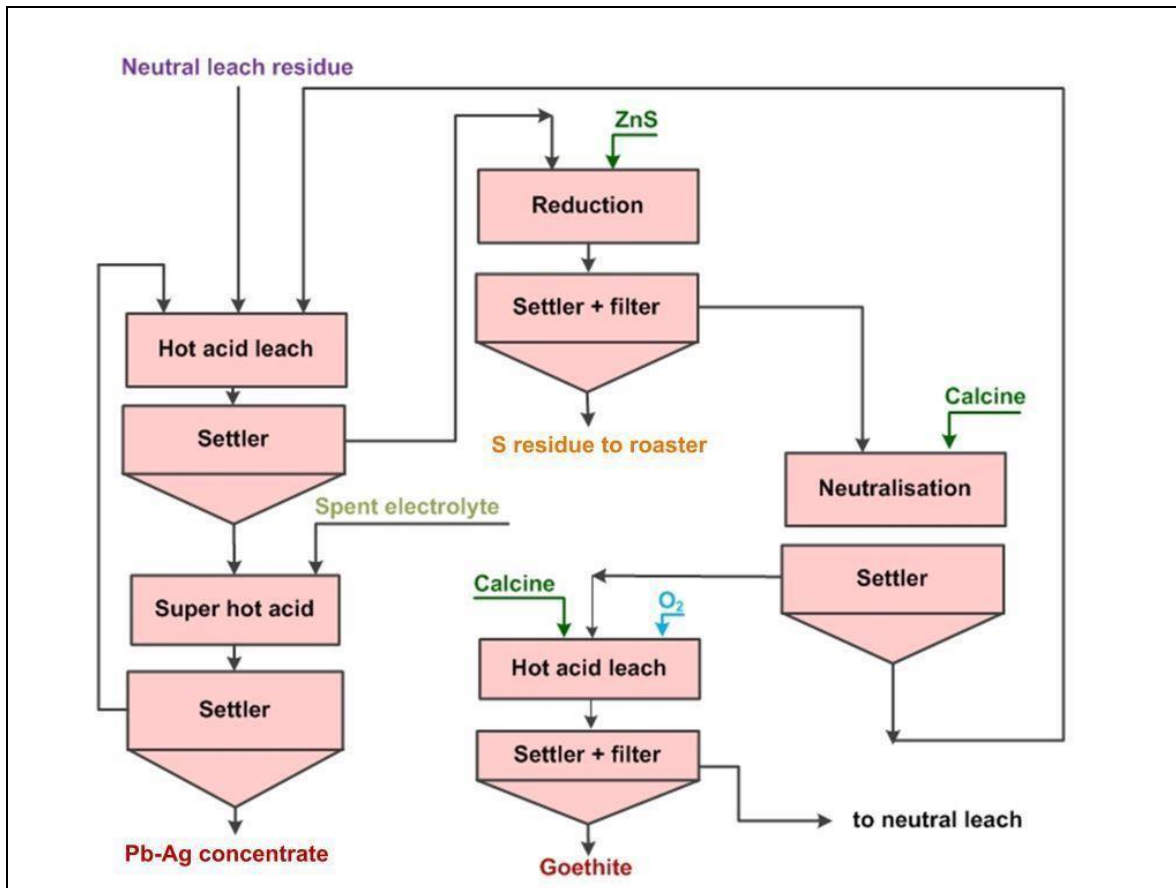

Figure 6.11: Example flowsheet for leach residue treatment in the goethite process

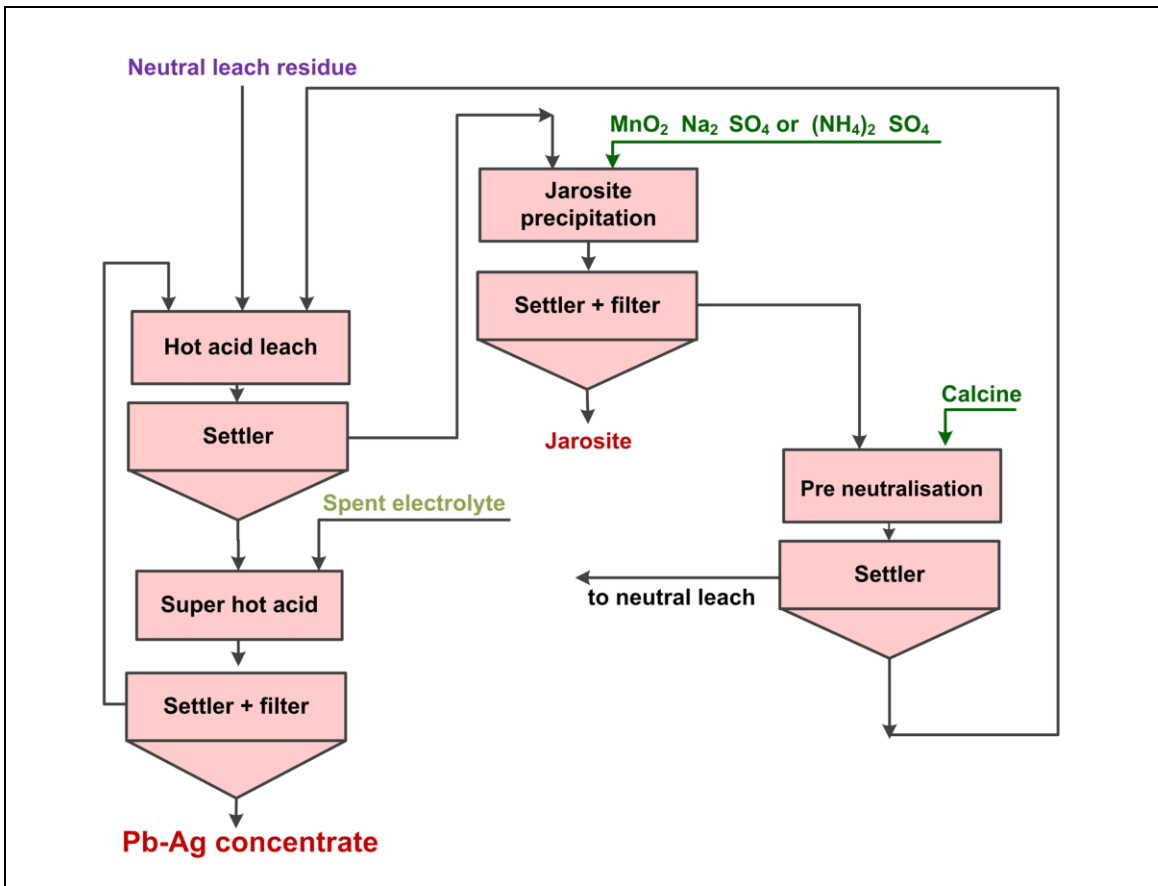

Figure 6.12: Example flowsheet for leach residue treatment in the jarosite process

Whatever residue is produced by the various process options, the zinc recovery yield is maximised by thoroughly washing the residue.

The iron-rich residues are stored in totally sealed disposal areas, usually on or near the site, to isolate them from ground or surface water. Environmentally safe storage in caverns is also applied. Water from the storage area is normally recycled back to the process. Developments have taken place to render the residue storage more efficient and acceptable by fixation in the Jarofix process or by compacting.

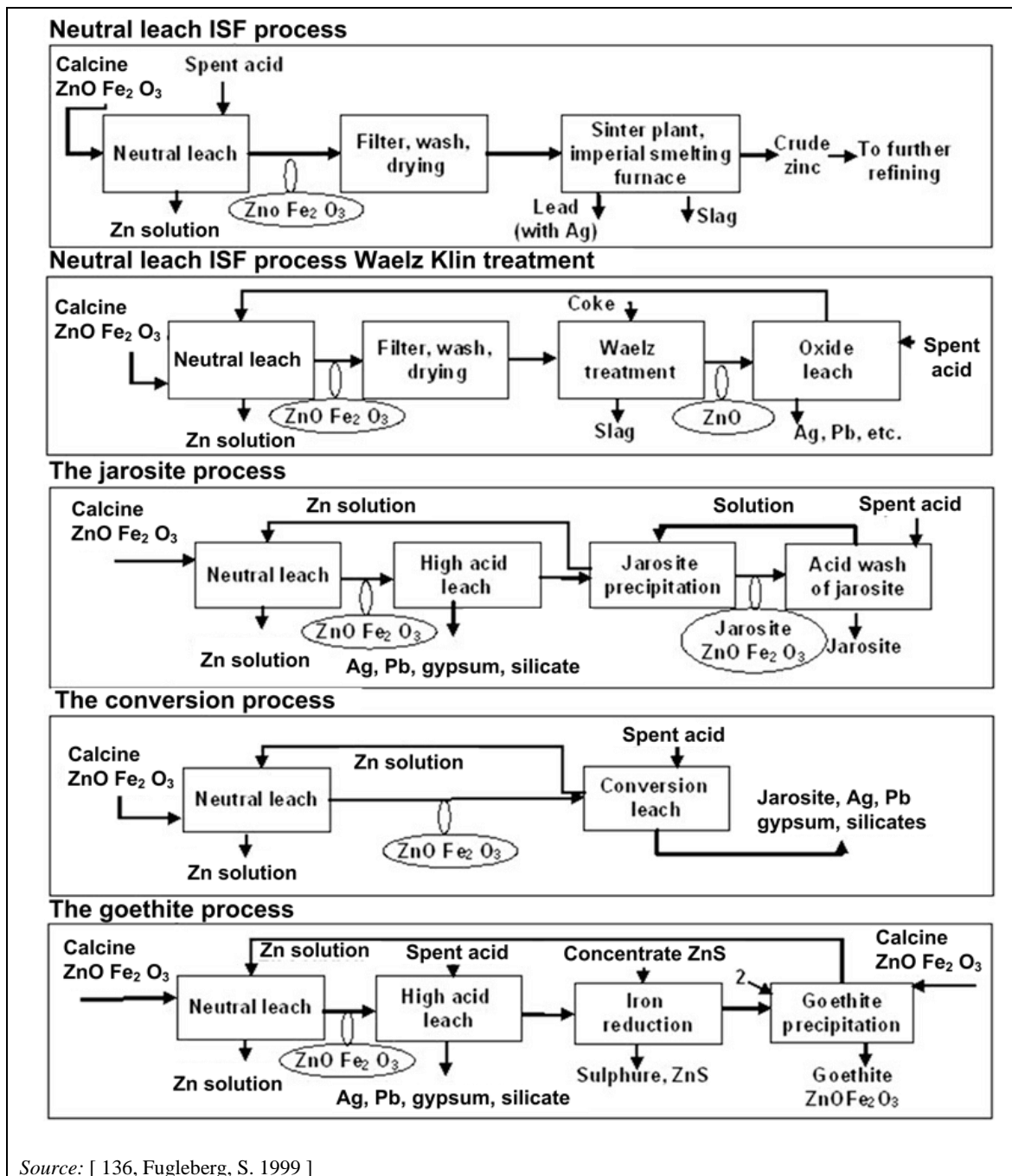

Figure 6.13: Simplified flowsheets of some iron removal processes

The RLE zinc refinery of Nyrstar in Budel (the Netherlands) is running on low-iron concentrates from the Century mine in Australia. Using low-iron concentrates makes it possible to have a leach residue which contains much less zinc and iron and which consequently is more concentrated in lead and silver. The leach residue from the Budel plant is therefore further processed in a pyrometallurgical process to recover lead, silver and other metals. This processing is done by a Pb-Ag-PM recycler. Consequently, the Budel plant has no iron residue that needs to be deposited in a pond.

Unfortunately, such a process using low-iron concentrates cannot be applied by all plants since there is only a very limited amount of low-iron concentrates available on the market. Part of this is used by most RLE plants to run the reduction step in order to minimise zinc losses. With the Century mine running towards depletion, it will become even more difficult to run a plant on 100 % low-iron concentrates.

6.1.2 Secondary zinc

Secondary or recycled zinc accounts for approximately 30 % of the yearly zinc consumption in Europe. Roughly 50 % of this secondary zinc is recycled within the industry. This is particularly true in the galvanising and brass sector; scrap arising from the production or processing of products can be recycled almost immediately.

Residues and scrap, which are relevant and significant to the secondary zinc industry, include:

- dust from copper and copper alloy production;
- slag from copper and lead processing;
- residues from the die-casting industry;
- ashes, bottom and top dross from the galvanising industry;
- old roofing and other sheet materials;
- non-ferrous fractions from the shredding of old cars and of other products mainly containing steel;
- dust from electric arc steelmaking and cast iron-making;
- residues from the chemical uses of zinc and from burnt tyres.

The process route used to recover zinc depends on the form and concentration of the zinc, and the degree of contamination [117, Krüger, J. 1999]. Different processes are applied for metallic, mixed metallic/oxidic and oxidic streams.

6.1.2.1 General processes

Physical separation, melting and other high-temperature treatment techniques are used. Zinc-rich residues are used to produce zinc metal, SHG zinc, zinc alloys, zinc oxide or zinc-oxide-rich products. The impure metals or alloys can be refined, e.g. in a distillation column, to produce SHG zinc or high-grade oxide or used directly in a secondary recovery process. If chlorides or other halides are present, they are removed before zinc is produced by hydrometallurgical processes due to their aggressive characteristics [117, Krüger, J. 1999], [202, Fundación Entorno, Empresa y Medio Ambiente 1999].

In plants for zinc recycling, visual inspection is applied to remove unwanted items like boots, shoes, gloves, plastics, wood, and steel wire which are often found in zinc ashes received from downstream users. All these items which are found in the zinc scrap bin need to be removed.

For classifying mixed metallic scrap, the most common physical separation technique is magnetic separation to remove items of iron. Manual and mechanical separation techniques are used to pretreat waste streams, such as the removal of batteries, mercury, etc. from electronic equipment according to the WEEE Directive.

Manual and mechanical separation is used for the removal of impurities from old zinc scrap. The separation makes it possible to recover more metals in dedicated processes.

Heavy media and relative density separation (sink/swim) is used by the scrap processing industry but may be encountered in the non-ferrous metals industry, for example in the processing of battery scrap to remove plastic material. In this case, the density and size difference of the various fractions are used to separate metal, metal oxides and plastic components using a water carrier.

Magnetic separation is used to remove pieces of iron to reduce the contamination of alloys. Generally, overband magnets are used above conveyors. Sloping hearths in a reverberatory furnace are used to melt zinc, lead and aluminium to leave large, higher melting point impurities (e.g. iron) in the hearth for further processing.

Moving electromagnetic fields (eddy current separation) are used to separate aluminium from other material. A variation on this technique uses this moving electromagnetic field to pump molten aluminium or other metals without direct contact between the metal and the mechanical components.

Other separation techniques involve the use of colour, UV, IR, X-ray, laser and other detection systems in combination with mechanical or pneumatic sorters. These are used, for example, to separate nickel-cadmium batteries from other battery types and techniques are being developed for other applications.

Process details are very often confidential but examples of these specific treatments are given below.

- Galvanisers' ashes which arise during galvanisation of workpieces, wire and tubes are essentially a mixture of zinc metal and zinc oxide. The presence of different metal compounds is related to the selected alloying elements of the galvanising bath. They are ball-milled to liberate the phases. Separation is accomplished by sweeping the mill with a stream of air to entrain the non-metallic components, which are then collected by a fabric filter. Alternatively, a screen is incorporated into the mill, which lets the fine non-metallic fraction pass, but retains the coarse metallic fraction. In either case, the metallic fraction is discharged from the mill, melted and cast into ingots for sale, reuse or further treatment.
- Bottom dross (also called hard zinc or spelter) is a zinc-iron mixture of intermetallic phases with some discrete metal particles which also contain some lead. It is formed in holding furnaces and tanks used for batch galvanising and accumulates. If it is not removed, the quality of the zinc coating is reduced and blockages may result, hence automatic removal systems are used. Top dross is a zinc-iron-aluminium alloy generated from continuous hot dip galvanising. Dross or skimmings and other residues from the die-cast industry contain a mixture of zinc metal and zinc oxide, with little or no chlorides. The treatment schemes summarised above are all applied to these materials. The same applies to old roofing and other sheet materials as well as to residues from the chemical uses of zinc or zinc products.
- Processing end-of-life vehicles in a series of mills produces shredder residue. After the removal of the non-metallic fraction, the non-ferrous fraction is separated from other steel-based products by magnetic separation. Heavy media separation and other techniques are then used to treat it, followed by selective melting to recover zinc.
- Zinc-containing dust (oxide mixture) can be fed to a clinker furnace, where the remaining halogens and lead are driven off by heating to 1000 °C. After the treatment in the furnace, ZnO is suitable to be used as raw material in a zinc smelter without further treatment.

Residues are melted in two stages in a gas-fired reverberatory furnace. In the first stage, lead is melted at 340 °C and is tapped and cast into ingots. In the second stage, the temperature is raised to 440 °C and zinc is melted, tapped and cast into ingots. An alternative process uses an indirectly fired rotary kiln with a perforated inner lining. Zinc melts and flows out through the liner into a holding furnace from where it is cast into ingots. Further refining is always necessary.

6.1.2.2 Solvent extraction processes for secondary zinc

See description in Section 6.1.1.3.4.2.

The SX stage is used to recover zinc from dirty secondary raw materials such as batteries. Other sources of secondary zinc materials include dusts and fumes from pyrometallurgical processes (e.g. copper smelters, electric arc steelmaking furnaces, etc.); combustion processes (e.g. domestic waste incineration, spent tyre incineration, etc.); and secondary zinc oxides from fuming processes like Waelz and Primus furnaces.

When applied to secondary raw materials, the process involves the upgrading and purification of the pregnant leach solution by solvent extraction (SX) to separate halides and metals from the zinc solution. The resulting purified electrolyte can be fed to a conventional electrowinning process.

This process was used in some plants in Spain to recover zinc from secondary materials (all these plants have now closed down). Nowadays (2014), this process is being used in a plant in Akita (Japan) to recover zinc from various zinc oxides' secondary materials. It was also reported that a recently commissioned zinc refinery located in Portovesme (Italy) would use it to treat Waelz oxide, and that there is another ongoing project in Forest City (US).

6.1.2.3 Waelz kilns

Waelz oxide is a zinc-rich intermediate product for use in zinc-winning processes. It is produced from residues, in particular the dust from electric arc steelmaking furnaces. Waelz kilns and slag fuming furnaces can be used.

The process is designed to separate zinc and lead from other materials by reducing, volatilising and oxidising zinc and lead again [99, Hähre, S. 1998], [117, Krüger, J. 1999]. The dust from electric arc steelmaking (EAF dust), other zinc-rich materials, coke breeze and materials that contain CaO are stored separately. For optimum process conditions, the feed materials can be homogenised and pelletised. They are then sent directly to the kiln-feeding system or for intermediate storage. Weighing equipment can be used to control the quantity of reduction materials (coke) according to the zinc content of the raw materials and of fluxes for the desired slag quality. There are some variations in the process depending on the slag basicity achieved [99, Hähre, S. 1998], [117, Krüger, J. 1999].

The normal operating temperature inside a Waelz kiln is about 1200–1400 °C. Inside the kiln, solid materials are first dried and then heated up by the countercurrent flow of hot gas and contact with the refractory-lined walls. Depending on the inclination, length and rotation speed, the material has an average residence time of between 4 and 6 hours in the kiln. In the strongly reducing atmosphere of the solid bed, zinc, lead and other metals are reduced. Zinc and lead are evaporated into the gas and chlorides and alkalis are vaporised together with other volatile metals and elements. As there is a surplus of air in the kiln, the metal vapours are oxidised. The mixed oxides are drawn from the kiln with the process gases and separated in the gas treatment system (see Figure 6.14).

The conventional basic Waelz process is applied in Plant I. In this plant, a charge consisting of EAF and containing 13–30 % zinc is mixed with coal and lime and fed into the Waelz kiln. The kiln has a length of 60 metres, an internal diameter of 3.6 metres, an inclination of 2 % and a usual rotation speed of 1 rpm. Inside the kiln, the solid material is transported from the feeding end to the discharge end by the rotation of the kiln and by its inclination.

The SDHL process (named after its inventors: Saage, Dittrich, Hasche and Langbein) is a further development of the conventional Waelz process using the basic slag system with the addition of a reoxidation step for iron at the end to reduce the energy consumption and to

improve the zinc yield and throughput [246, France 2008]. It was patented in 2000. It can be retrofitted to existing Waelz plants. In a conventional Waelz process, the coke is fed at a rate above stoichiometric requirements and results in residual coke in the slag. In the SDHL process, coke is added substoichiometrically (only about 70 % of the coke needed) and the metallic iron portion is reoxidised at the kiln end by the targeted addition of air to provide the extra process heat.

Due to the release of energy by the oxidation of iron, no additional natural gas input is needed at normal operation. Up to 40 % reduction of coke breeze input is possible and higher throughput, higher zinc recovery and a reduction of CO₂ emissions are achieved. [234, UBA (D) 2007]

The results indicate that the basic slag system (obtained by adding lime to the charge) achieves a PCDD/F reduction by a factor of about 10, a fluorine fixation in the slag with a share of 60 % and a longer lining lifetime is also possible.

The gas treatment system typically comprises a settling chamber for the removal of coarse dust that is carried over mechanically and which is fed directly back to the furnace. The hot process gases are cooled down using various direct or indirect coolers. An electrostatic precipitator or fabric filter is used to separate the Waelz oxide from the cooled gases. Techniques to minimise and remove PCDD/F are used where needed. In Waelz plants, an adsorbent comprising Waelz oxide and lignite or activated carbon is used in a two-stage process. A post-combustion chamber can be used to minimise the emission of VOCs.

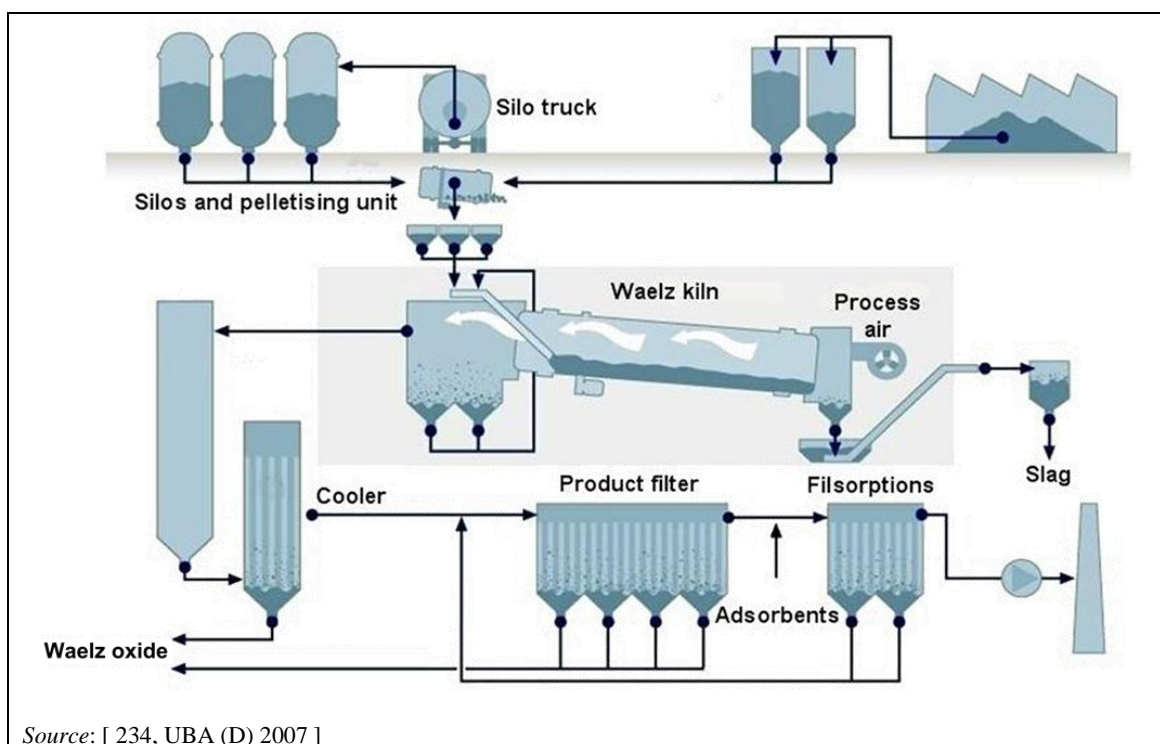

Figure 6.14: Flowsheet of the Waelz process

The slag produced is discharged continuously from the end of the furnace into a water quench system. After cooling and screening, the slag from the SDHL process is used as a construction material for landfill and can be used as a material in civil engineering, e.g. for road construction, after suitable performance in the leachability tests.

Slag from the Waelz processes used to treat residues from zinc production processes can be treated in a flotation process after the slag has been crushed. The flotation process produces a copper-rich portion which is returned to a copper or lead smelter for metal recovery. This

method is used where the tailings can be adequately treated (see the BREF on Management of Tailings and Waste-rock in Mining Activities).

The Waelz oxide that is produced can be processed in a number of ways. The most basic process is hot briquetting or sintering for sale to pyrometallurgical zinc plants, e.g. Imperial Smelting Process. If the lead oxide content is high, a calcination step can also be used to volatilise the lead.

Waelz oxide can also be washed with water and sodium carbonate, sodium bicarbonate or possibly sodium hydroxide in a two- or three-stage process using the countercurrent flow principle. By these additions, metal chlorides can be precipitated as metal carbonates or hydroxides. Besides the removal of chloride, this washing process allows the removal of fluoride, sodium and potassium. The alkalis of the rich liquor from the first washing step can be removed by a crystallisation step to produce a salt residue and an alkali-free condensate. The salt residue is disposed of underground. The condensate can be recycled; in this case the whole process can work without producing waste water. The washing processes are shown in Section 6.3.2.2.3.4.

In Europe, most of the Waelz oxide is washed and subsequently treated in a RLE plant.

A two-stage process and effluent treatment can be carried out as the discharge of the bleed that contains chlorine is possible. In comparison to the washing and crystallisation process, the advantages of the two-stage washing are the lower energy consumption, the lower operational costs, the lower investment costs and the avoidance of a solid residue.

6.1.2.4 Slag fuming processes

These processes are also used to recover zinc from residues. Electric arc furnace dust, most of the slags from lead smelting operations, complex zinc-copper slags from copper smelters and other residues from zinc reduction processes contain lead and zinc that will be lost if they are not treated further. These materials may be fumed with a source of carbon such as coal, to recover lead and zinc and to raise heat from the process [117, Krüger, J. 1999].

Cyclone or converter-type furnaces are used to raise the temperature above 1200 °C to volatilise the metals and then form the oxides that are subsequently recovered from the gases in a filtration stage. The cyclone furnace is operated with oxygen-enriched air but the converter is operated with substoichiometric air. Excess heat is produced and this is recovered in a waste heat boiler and electricity is generated. The slag produced is used for construction purposes or landfill, depending on leach test results and local legislation.

The Ausmelt/ISASMELT furnace, the multiple hearth furnace and the submerged plasma arc furnace are also reported to be used to treat steelmaking dust, leaching residues and coating sludges to recover zinc as an alternative to the Waelz process [227, IZA Report 2008]. It is reportedly used to produce steel and other metals from the residues in conjunction with a reduction furnace [257, Paul Wurth 2008].

6.1.2.4.1 The plasma arc fuming process

This fuming process can be used to treat metal oxides, such as bag filter dust from electric arc steelmaking furnaces or secondary materials such as complex slags containing zinc and ZnO. The materials are fed into the slag bath of a plasma arc furnace where the reactions take place, producing ZnO. Coke or a similar material is used as the reducing agent. A slag-former is added, if needed, to the feed. The different metal oxides are reduced according to the equilibrium determined by the slag temperature and oxygen potential. [350, Heegaard 2009]

The slag temperature is controlled by the plasma power and the slag composition. The power consumption is about 1.2 MWh/t of EAF dust fed. The oxygen potential is adjusted by the coke feed rate and liquefied natural gas flow in the tuyères.

Reduced metals with a high vapour pressure such as lead and zinc leave the furnace as metal vapour. The off-gas exits the furnace at temperatures of about 1300 °C. Off-gases are reoxidised by air to produce ZnO and PbO. If reoxidation takes place in the furnace, about a third of the heat generated can be recovered by heating up the slag, therefore reducing the power consumption of the plasma generator.

The recovery rate of zinc is about 92 % and the ZnO content is about 88 %.

A stable, insoluble slag with a lead content of about 0.1 % is produced as a by-product. The slag basicity $(\text{CaO}+\text{MgO})/\text{SiO}_2$ is around 1. The slag is used in various industries such as concrete manufacturing and/or construction.

6.1.2.4.2 The fuming furnace process for the production of secondary ZnO from the copper smelter

This process, which is integrated as part of a copper smelter, can be used to treat metal oxides such as bag filter dust from electric arc steelmaking furnaces or secondary materials such as complex slags from a copper smelter containing zinc and copper. The zinc-rich slag is processed in a fuming furnace where the zinc is vaporised with the help of oxygen and carbon. Carbon monoxide is formed and the zinc oxide is reduced to metallic zinc.

The recovery rate of zinc is about 85 % and the ZnO content is about 70–75 %.

The slag from the fuming furnace is transferred to a settling furnace. After a certain retention time, a copper matte is separated from the slag and recycled to the copper smelter. The remaining slag is granulated to form a chemically stable iron sand whose drainage properties allow it to be used in road and building construction.

6.1.2.5 Remelting and refining

Clean and unmixed secondary zinc scrap is remelted or refined to secondary zinc grades. Impurities, like aluminium- or iron-bearing materials, are mainly removed mechanically in the separation step before the melting, if possible. Mixed scrap can be pretreated in a separation melting furnace to remove zinc from metals with a higher melting point.

Melting is mainly conducted in induction furnaces. After the melting, the segregation and alloying step follows. In the first step, impurities can be partly or completely removed depending on the solubility of the element in the melt. Alloying elements can be added, if required.

6.1.3 Melting, alloying and casting processes for zinc

6.1.3.1 Melting and alloying processes for zinc

Melting and alloying are usually carried out in indirectly fired crucible furnaces or induction furnaces. The temperature is controlled to ensure that zinc is not volatilised, forming fumes. The fuel is usually either gas or oil. The gas or oil burner can be located outside the crucible, which is encased in a combustion box, or inside the crucible as an immersion tube heater [12, HMIP (UK) 1994], [98, Lijftogt, J.A. et al 1998].

Direct heating is applied in aluminium melting furnaces (sometimes molten aluminium is added to the zinc alloying furnace instead of solid aluminium). Direct heating is also applied in zinc holding furnaces, which are situated between the melting and casting section.

In both cases, temperature control is critical, as the casting temperature must not exceed 600 °C for most alloy compositions to avoid metal loss by fuming. Alloy additions are usually made as solids, but in certain operations molten aluminium is added from an adjacent melting furnace.

When alloys are made from impure raw materials, fluxes are needed to absorb the impurities. The standard flux contains zinc chloride and/or double salts with ammonium chloride; some fluxes are also designed to be free of halogens. While adding these substances or during the cleaning operations of the furnace, diffuse emissions of dust and fumes can occur. Fluoride-containing fluxes are no longer used as the use of this type of flux results in the emission of gaseous fluoride compounds, which need to be removed by wet scrubbing.

The zinc bath is periodically skimmed to remove solid dross: zinc oxide and zinc chloride. A flux is often added to reduce the loss of zinc in the dross. The oxidic fraction of the dross can be recycled within the ISF or back to the roaster in the electrolytic zinc process.

When melting zinc cathodes, zinc alloys and zinc scrap, the following intermediate materials may be produced.

- Zinc dross. It is generated at the melting furnace and consists of a scum formed on the surface of the molten metal that contains metallic and oxidised zinc. It is skimmed from the surface of the bath by mechanical or manual means.
- Zinc-bearing dust and fumes. They are captured from the gas stream leaving the melting furnace by means of abatement devices such as bag filters.

In most cases, all these residues are internally or externally recycled for the recovery of zinc.

6.1.3.2 Casting processes for zinc

Metal is usually cast into permanent moulds that are commonly made of cast iron or cast steel. Stationary or continuous conveyor casting machines are used.

Static moulds and conveyor casting machines are used to produce blocks and ingots. Continuous casting machines are used to produce rod for reduction to wire.

When casting zinc or zinc alloy ingots, metallic dross may be produced. It is a scum manually removed from the casting. In some automated processes, the amount produced is nil or negligible. In most cases, this residue is internally or externally recycled for the recovery of zinc.

6.1.3.3 Production of zinc powder ('zinc dust')

Zinc powder is produced as a product for other industrial processes and as a reagent for use during the leach liquor purification route. Molten zinc produced by the same techniques outlined above is sprayed under pressure through an atomising nozzle and is then rapidly cooled in an inert atmosphere to produce dust [117, Krüger, J. 1999]. Air, water or centrifugal atomisation of a stream of molten zinc can also be used to produce dust. The dust is removed in a fabric filter system and conveyed to the relevant process or packaged.

6.1.4 Cadmium

6.1.4.1 Production of cadmium from primary zinc processes

Cadmium is produced as a by-product from many of the metal recovery processes. The production of zinc and lead are the main sources [117, Krüger, J. 1999].

In the Imperial Smelting Furnace (ISF), cadmium is recovered via two separate routes. Some cadmium follows zinc and is eventually recovered as condensate from the second distillation stage. This cadmium contains zinc and requires further purification. The rest is recovered from the flue-dust from the gas-cleaning section that precedes the sulphuric acid plant. It is leached with sulphuric acid and is then stripped from this liquor as cadmium cementate which needs further purification.

Cadmium cementate, recovered from the purification of zinc solutions in the RLE process can also be refined hydrometallurgically. In this process, the cementate is leached in a sulphuric acid medium, the solution purified, and cadmium metal is electrowon. The purified $ZnSO_4$ solution is returned to the main zinc circuit [234, UBA (D) 2007].

Cadmium cementate can also be refined by compacting and melting with soda to remove zinc. Optionally, an additional distillation step can be applied to obtain a high-purity cadmium.

Cadmium can also be recovered as cadmium chloride liquor by an ion exchange process. The liquor is directed to an immersed drum high-grade zinc strip that starts an exchange reaction and results in the production of cadmium sponge and zinc chloride liquor. The sponge, from this process, from the cementate process or from sulphate solutions, is melted with caustic soda (sodium hydroxide) flakes to remove the remaining zinc and the product is cast and sold or, if impure, sent for further cadmium refining.

Cadmium can also be recovered from waste streams as a carbonate. Leaching and electrowinning techniques can be used to recover it.

In the cadmium refinery, cadmium from the routes described above can be molten and cast in commercial shapes. When the purity is not sufficient, cadmium is further distilled at high temperatures. The condensate is cadmium that contains approximately 1 % zinc and the run-off is high-grade zinc. Eventually, the cadmium fraction can be melted with caustic soda and sodium nitrate to remove residual zinc.

Technical measures are taken by the cadmium industry to comply with the EU's indicative occupational exposure limit value (IOELV) of $4 \mu\text{g}$ of respirable Cd/m^3 proposed by the Scientific Committee on Occupational Exposure Limits (SCOEL) in compliance with Article 3 of Directive 98/24/EC (2009). This value is applicable to cadmium and cadmium compounds in general, unless the limited solubility of a given cadmium compound is documented. To reach this workplace air concentration, diffuse emissions must necessarily be low.

Flowsheets of different cadmium production routes are shown below.

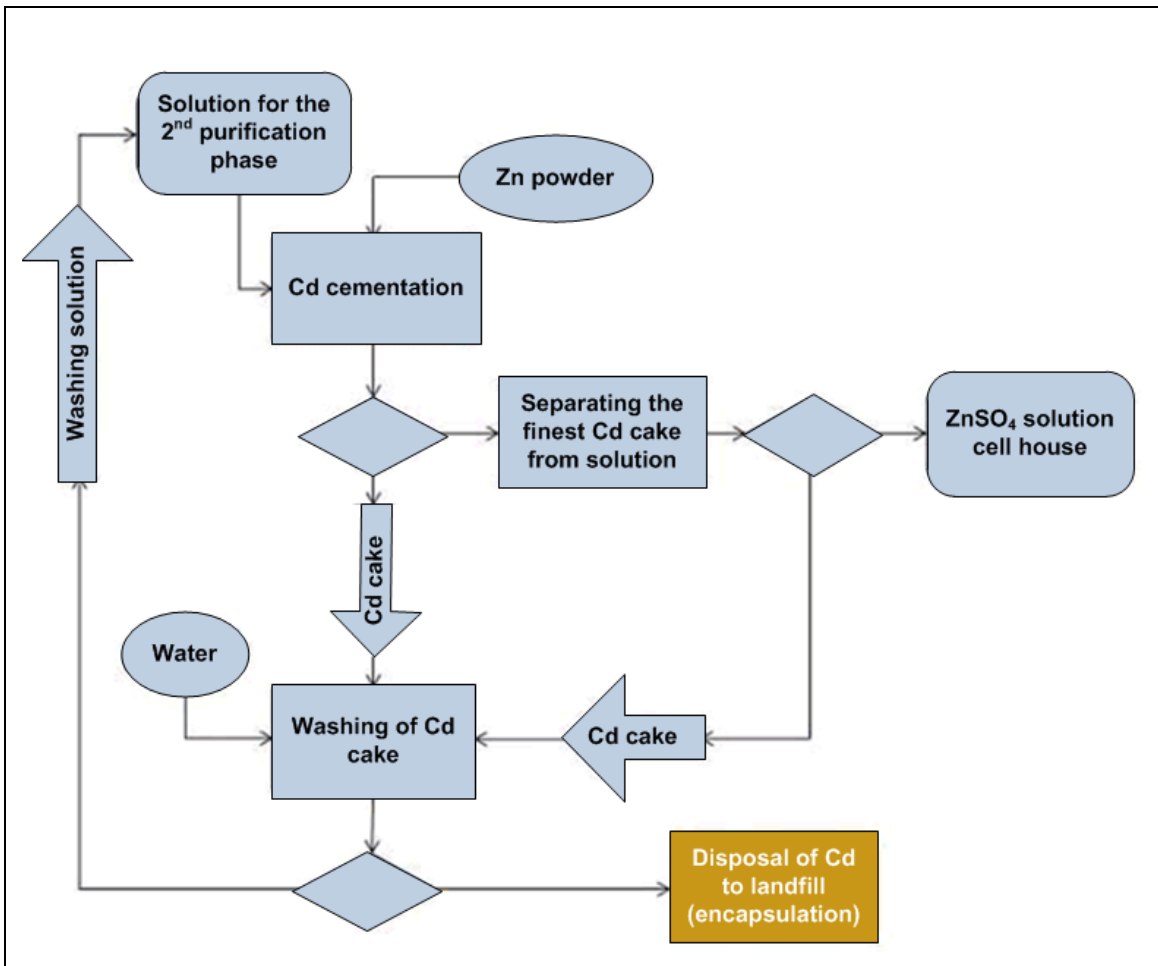

Figure 6.15: Cadmium production flowsheet: Plant A

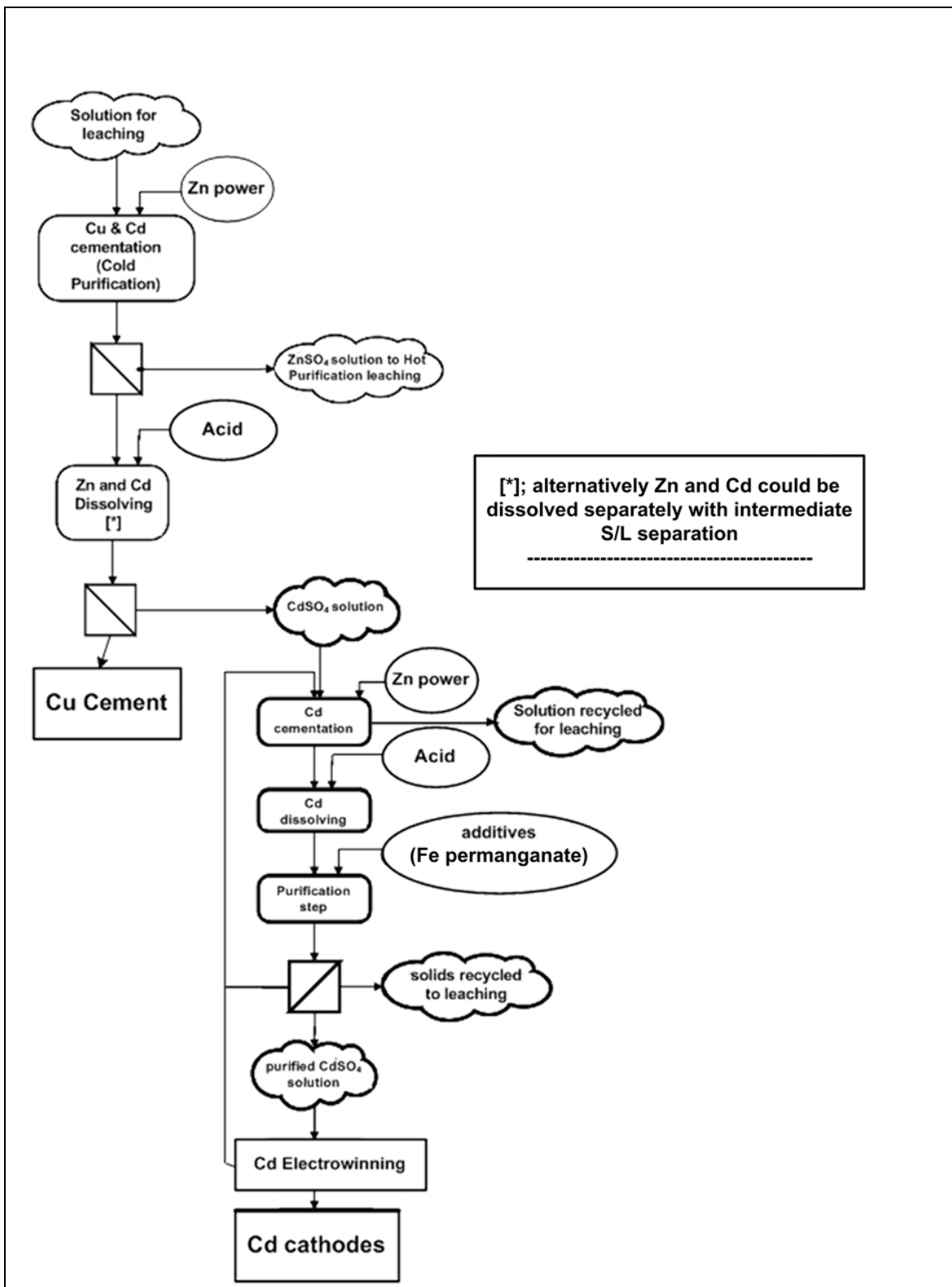

Figure 6.16: Cadmium production flowsheet: Plant B

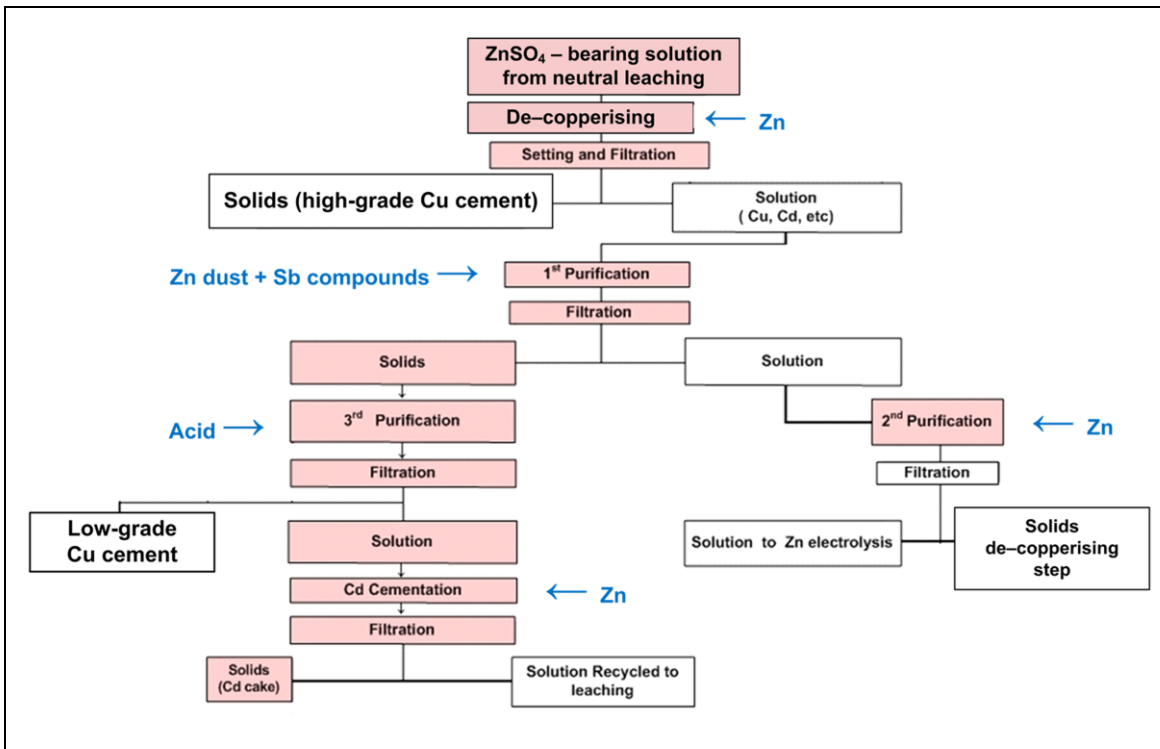

Figure 6.17: Purification flowsheet including cadmium production: Plant C

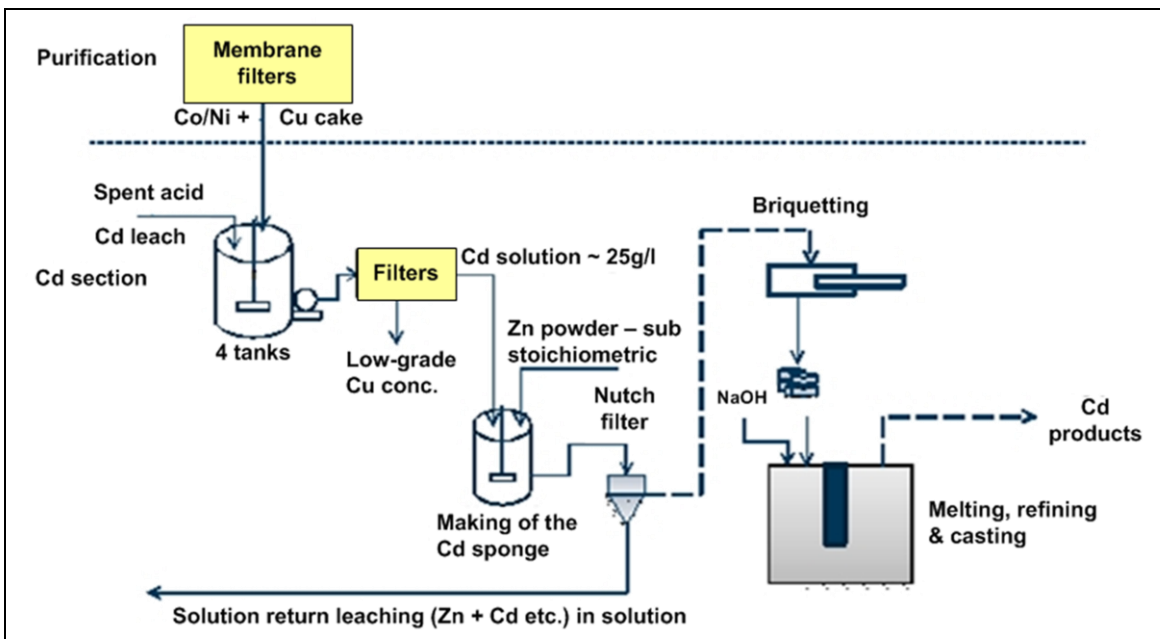

Figure 6.18: Cadmium production flowsheet: Plant D

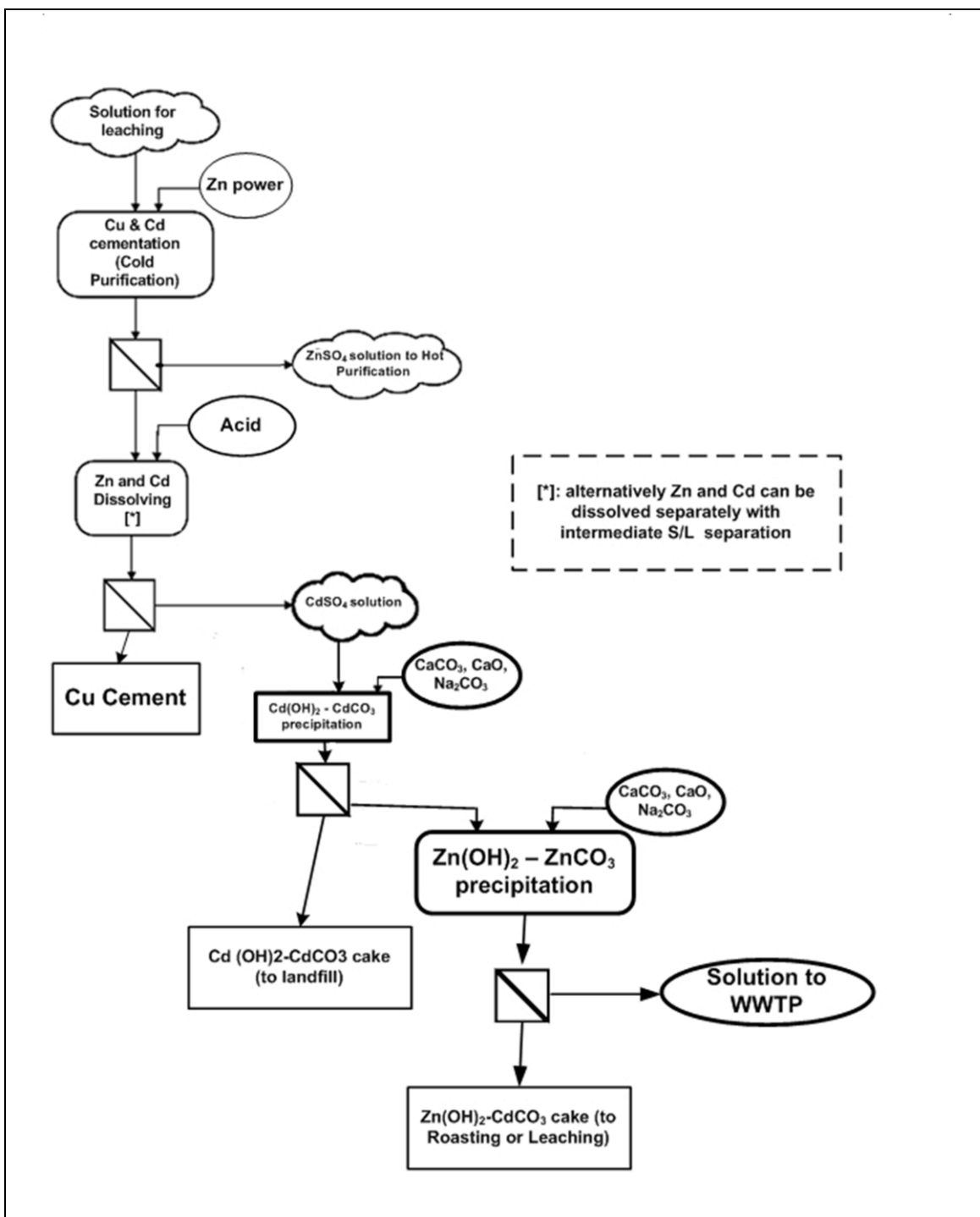

Figure 6.19: Cadmium production flowsheet: Plant E

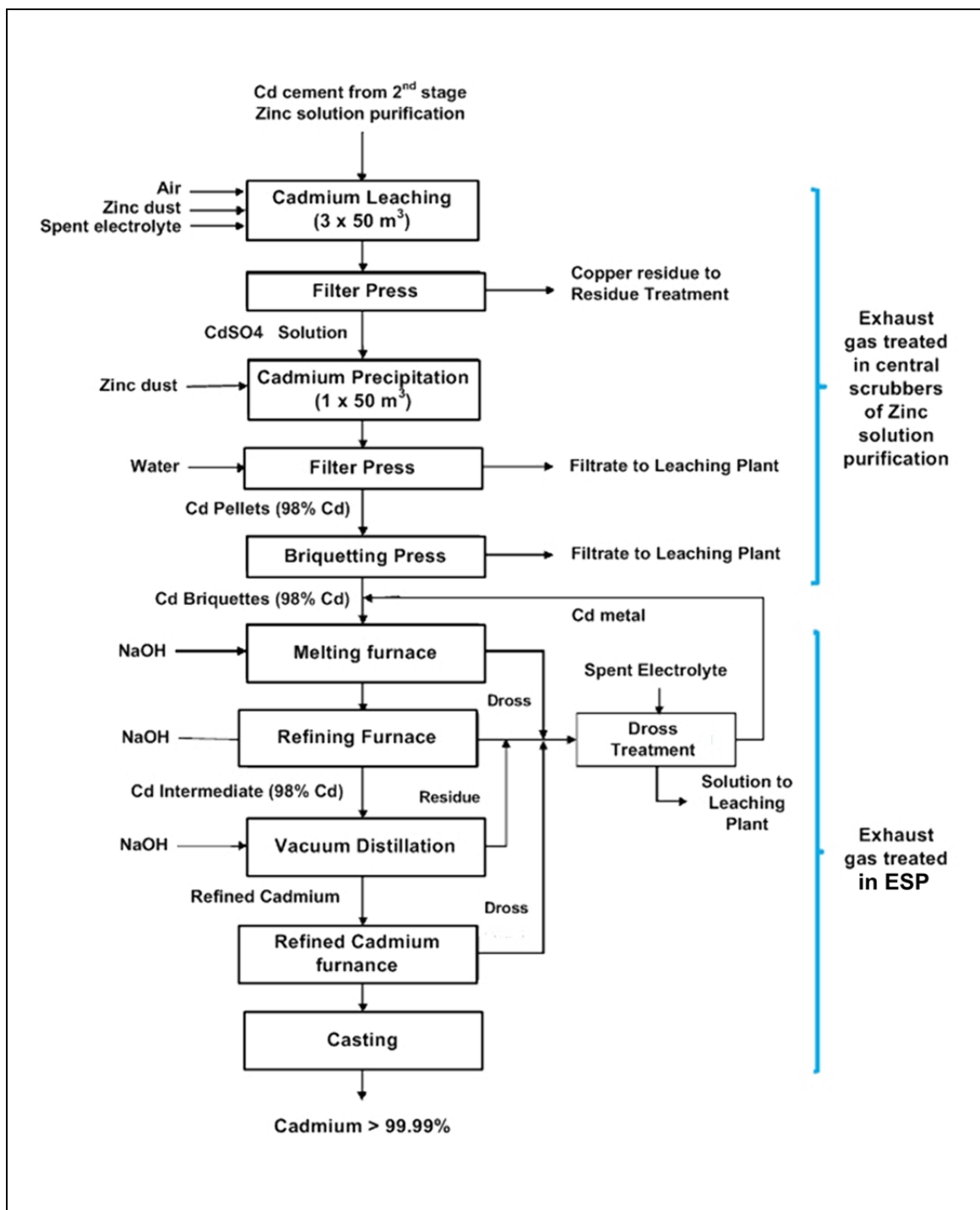

Figure 6.20: Cadmium production flowsheet: Plant F

6.1.4.2 Production of secondary cadmium, mainly from batteries

The other main source of cadmium is the recycling of Ni-Cd batteries. There are two types of batteries: consumer-implicated sealed batteries and industry-implicated vented cell batteries.

The main components of these batteries are:

- anode: cadmium;
- cathode: NiOH on a steel mesh;
- membranes and separators: polymer and paper;
- casing: steel and plastics;

- electrolyte: KOH.

The recycling process consists of three steps.

- Sorting

Industrial as well as consumer cells need to be identified and sorted, in order to minimise the number of impurities. The sorting quality determines the purity of the recovered cadmium and Ni-Fe fraction.

- Preparation for recycling of cadmium

Industrial used vented batteries

Industrial cells are drained of liquid potassium hydroxide and dismantled manually. All cadmium-containing parts are forwarded to the cadmium distillation. Other components (electrolyte, polymers, iron and nickel) are recycled. Dismantling is done in confined areas. Air ventilation passes through a cassette filter.

Consumer used sealed batteries

Consumer-type batteries, commonly returning as plastic packaged power tool batteries, are most often treated mechanically to separate the plastic casings. The separated plastics are recycled to the plastic industry or sold as fuel.

The remaining organic fraction and water is removed by pyrolysis at 400–500 °C. The aim of the process is to evaporate water, to decompose the organic fraction by thermal cracking and to separate it by evaporation from the metallic fraction. The remaining metallic fraction is forwarded to the distillation process.

Pyrolysis can be carried out with electric heating or propane gas heating. Gases are filtered before emission to the atmosphere. The cracked hydrocarbons can be recovered by condensation as an oil-like product which can be sold as combustible or burnt off in an afterburner with recovery of the heat. When an afterburner is applied, filtering techniques (e.g. wet scrubber, bag filter, activated carbon filter) are used in combination with it.

- Cadmium distillation

Finally, cadmium is extracted from the metallic fraction by distillation. A reducing agent (coke) is added to reduce the oxides. The distilled cadmium has a purity of 99.95 %. The condensed liquid cadmium can be recovered by dripping it into water to make pellets or it can be cast into ingots.

The remaining metallic fraction contains nickel and iron with very low cadmium contamination. Optionally, the Ni-Fe fraction can be homogenised by melting. This Ni-Fe residue is sold to the stainless steel industry.

6.1.4.3 Production of other metals (In, Ge, Ga)

Other metals are sometimes present in the concentrates that are used for zinc and lead production. They tend to be concentrated in the slags, dross, flue-dusts and residues produced during processing and, optionally, these residues can be the feed material for special units designed to recover these valuable metals.

Recovery processes can be complex and many are commercially confidential. The processes combine several techniques such as leaching, cementation, solvent extraction, chlorination, electrowinning and vacuum distillation. These techniques can be followed by zone refining and crystal growth techniques to produce ultra-pure metals.

6.2 Current emission and consumption levels

The main environmental issues of the zinc processing industry are air and water pollution and the generation of hazardous wastes. The facilities generally have their own waste water treatment facilities and waste water recycling or reuse is usually practised.

Surface water and landfill control water can be captured to supplement the water demand of the process and losses due to evaporation. When the volume of water to be bled from the process allows it, a final crystallisation step (e.g. in some Waelz operations in Germany) can be carried out, hence avoiding any emission to the receiving water body.

Many wastes are reused but the main item is leach residue, which has a high environmental impact [98, Lijftogt, J.A. et al 1998] [99, Hähre, S. 1998]. Some local aspects, like noise, are relevant to the industry. Due to the hazardous nature of some solid and liquid waste streams, there is also a significant risk of soil contamination [237, UBA (A) 2004].

Table 6.2 gives input and output balances for a German RLE plant.

Table 6.2: Typical data for a German RLE plant with integration of secondary raw material

Material	Description	
Feed	Concentrates (47–56 % Zn) Waelz oxide (55–70 % Zn)	1.3–1.8 t/t SHG Zn Possibly 0.03–0.58 t/t SHG Zn
Products	SHG zinc (99.99 %) Cadmium ⁽¹⁾ Sulphuric acid, e.g. 96 %	3–4 kg/t SHG Zn 1.23–1.68 t/t SHG Zn
Waste	Goethite ⁽¹⁾ or jarosite ⁽¹⁾ Dewatered acid sludge Cadmium residue ⁽¹⁾ Hg/Se sludge Precipitated sludge	0.3–0.8 t/t SHG Zn < 0.5 kg/t SHG Zn 3–4 kg/t SHG Zn 0.3 kg/t SHG Zn 7–15 kg/t SHG Zn
Intermediates/ By-products	Pb sulphate ⁽¹⁾ Cu concentrate Zn/Fe concentrate (neutral leach residue) ⁽¹⁾ Calomel ⁽¹⁾ Gypsum	115 kg/t SHG Zn 7–15 kg/t SHG Zn 0.5–1 t/t SHG Zn < 4 kg/t SHG Zn < 4 kg/t SHG Zn
Typical production	SHG zinc Sulphuric acid Cadmium ⁽¹⁾	130 000 t/yr 225 000 t/yr 480 t/yr
⁽¹⁾ Depending on the process window. Source: [234, UBA (D) 2007]		

Table 6.3 gives the typical composition of feed and products for a RLE plant with integration of secondary material.

Table 6.3: Typical composition of feed and products for a zinc RLE plant with integration of secondary raw material

Metal (%)	Zn concentrate	Zn/Fe concentrate	Cu-rich residue	Pb sulphate	Pb/Ag neutral leach residue	Jarosite
Zn	54	18–21	8	4	2.5	5.5
Fe	6.7	17–19	0.3	2	5	27
Pb	2.1	7–8	4	40	25	4.9
S	32	6–9	2	11	NR	NR
Cu	0.4	0.6–1	51	0.05	NR	0.2
Cd	0.2	0.1–0.2	1.2	NR	0.2	0.06
Ag	0.01	0.04–0.06	< 0.01	0.04	0.01	NR
SiO ₂	NR	4–7	0.7	2	25	0.24

NB: NR = Not reported.
Source: [234, UBA (D) 2007]

Table 6.4 shows input and output balances for a Waelz plant treating EAF dust.

Table 6.4: Input and output data for a Waelz plant using the SDHL process

Inputs	t/t dry product	Outputs	t/t dry product
Step 1: Waelz kiln operation			
Zn residues (EAF dust, etc.)	2.68	Waelz oxide (unwashed)	1
Coke breeze	0.48	Slag (dry)	1.63
CaO, lime	0.21	Clean off-gas (Nm ³ /t)	2.07
Industrial water (m ³ /t dry product)	1.22		
Natural gas ⁽¹⁾ (Nm ³ /t dry product)	3.66		
Electrical energy (kWh/t dry product)	240		
Diesel oil (m ³ /t dry product)	< 0.001		

⁽¹⁾ Natural gas in Waelz kiln only for preheating, not for normal operation mode.
Source: [234, UBA (D) 2007]

Waelz oxide contains high levels of chlorine and needs to be washed before leaching in a RLE plant. Table 6.5 provides input and output data for Waelz oxide washing with and without crystallisation.

Table 6.5: Input and output data for a Waelz oxide washing process

Inputs	t/t dry product	Outputs	t/t dry product
Step 2a: Washing operation with crystallisation			
Waelz oxide (unwashed)	1.13	Waelz oxide (washed)	1.0
Sodium carbonate	0.06	Alkali residue	0.13
Industrial water (m ³ /t dry product)	1		
Natural gas (Nm ³ /t dry product)	15		
Electrical energy (kWh/t dry product)	94		
Step 2b: Washing operation without crystallisation			
Waelz oxide (unwashed)	1.13	Waelz oxide (washed)	1.0
Sodium hydrogen carbonate	0.06	Effluent (m ³ /t dry product)	4
Industrial water (m ³ /t dry product)	4		
Natural gas (Nm ³ /t dry product)	33		
Electrical energy (kWh/t dry product)	36		

Source: [267, BEFESA 2008]

Regarding slag fuming processes, information about the inputs and outputs of the plasma arc fuming process and the material balance of the plasma arc fuming process and the fuming furnace in a process for production of secondary ZnO from a copper smelter can be found in Table 6.6 and Table 6.7.

Table 6.6: Material balance of the plasma arc fuming process

Inputs (kg)		Outputs (kg)	
EAF dust	1000	Slag	426
Coke	80	Gas	7505
Sand	90	Product	494
Compressed air	5915		
Water	1286		
LNG oil	54		
Total	8425		8425
<i>Source: [399, IZA 2012]</i>			

Table 6.7: Average throughput of zinc and consumables

Inputs (kt/yr)		Outputs (kt/yr)	
Copper slag	290–300	Granulated slag	265
EAF dust	25	Speiss/matte	4.5
Coal	45–50	Zinc clinker	40
WRD oil	1.1 tonne	Pelletised clinker dust	5
		CO ₂	150
<i>Source: [399, IZA 2012]</i>			

6.2.1 Energy

The energy requirements for the different zinc processes vary to a large extent. They depend on the quality of the feed and the products, the use of latent or waste heat and the production of by-products. Table 6.8 shows the average energy requirements of the different processes, excluding the energy content in the raw material.

Table 6.8: Energy requirements of various zinc processes

Process	Product	Electrical (kW/h per t)	Coke (kg/t)	Natural gas (Nm ³ /t)	Water for leaching (m ³ /t)
RLE ⁽¹⁾	SHG zinc	3850–4905	0.48 GJ/t average for other energy	NR	NR
ISF & NJ distillation	Zinc metal	1050 750	1100 785	220 160	NR
Slag fuming	Slag	150	250	NR	NR
Waelz kiln					
SDHL without washing	WO unwashed	240	480	4 ⁽²⁾	NR
SDHL with 2-stage washing	WO washed	300	540	38	6
SDHL with 3-stage washing and crystallisation	WO washed	360	540	19	1
⁽¹⁾ Total energy: 13.86–20.00 GJ/t without energy credits. ⁽²⁾ For preheating only. NB: NR = Not relevant. Source: [234, UBA (D) 2007]					

6.2.2 Emissions to air

The emissions to air are either captured as stack emissions or can escape the process as diffuse emissions depending on the age of the plant and the technology used. Stack emissions are normally monitored continuously or periodically and reported. Diffuse emissions are a cause for concern and should be captured.

The main emissions to air from zinc production are:

- sulphur dioxide (SO₂), other sulphur compounds and acid mists;
- oxides of nitrogen (NO_x) and other nitrogen compounds;
- metals and their compounds;
- dust;
- VOCs and PCDD/F.

Other pollutants are considered to be of negligible importance for the industry, partly because they are not present in the production process and partly because they are immediately neutralised (e.g. chlorine or HCl) or occur in very low concentrations (e.g. CO). Emissions are to a large extent bound to dust (except cadmium, arsenic and mercury, which can be present in the vapour phase) [98, Lijftogt, J.A. et al 1998].

The sources of emissions depend on the process used and are shown in Table 6.9 and can be:

- transport and handling of material;
- roasting/sintering and sulphuric acid plant (most emissions occur during unscheduled shutdowns);
- pyrometallurgical operations: fuming, smelting and refining;

- hydrometallurgical operations: leaching, purification and electrolysis;
- mechanical treatments: grinding, milling and granulation;
- casting.

Table 6.9: Significance of potential emissions to air from zinc and cadmium production

Component	Roasting & Other pyromet. treatments	Leaching and purification	Electrolysis	Mechanical treatments	Casting, etc.	Sulphuric acid plant
Sulphur oxides and sulphates	•• ⁽¹⁾	•	•• (acid mist)	•	•	•••
Nitrogen oxides	• ⁽¹⁾	NR	NR	NR	•	•
Dust and metals	••• ⁽¹⁾	•	•	•••	•••	NR
VOCs and PCDD/F	•(••) ⁽²⁾	NR	NR	NR	• ⁽¹⁾	NR

⁽¹⁾ The direct emissions from the roasting or smelting stages are treated and/or converted in the gas-cleaning steps and sulphuric acid plant; the remaining emissions of sulphur dioxide and nitrogen oxides of the sulphuric acid plant are still relevant. Diffuse or uncaptured emissions are also relevant from these sources.
⁽²⁾ PCDD/F and VOCs may be present if secondary materials are used that contain PCDD/F or are contaminated with organic materials. VOCs may also be present during solvent extraction processes.
 NB: ••• More significant – • Less significant.
 NR = Not relevant.

Besides process emissions, diffuse emissions occur. The major diffuse emission sources are [98, Lijftogt, J.A. et al 1998]:

- dust from the storage and handling of concentrates;
- leakage from roasters and smelters;
- aerosols and dust from the exhaust gases of leaching and purification vessels;
- exhaust gases from the cooling towers of the leaching and purification units;
- exhaust gases from the cooling towers of the electrolytic process;
- miscellaneous.

Table 6.10: Emissions to air from different RLE plants in Europe

Origin	Amount (t/yr)	Specific emission (g/t zinc)
Dust from the storage and handling of concentrates and calcine	< 0.25	0.25–0.75
Aerosols and dust from the exhaust gases of leaching and purification vessels	< 2	1–9
Exhaust gas from the cooling towers of the leaching and purification units	< 4	2–16
Exhaust gas from the cooling towers of the electrolytic process (0.8 t/yr)	< 5	3–20

Source: [399, IZA 2012]

Although diffuse emissions are difficult to measure and estimate, there are some methods that have been used successfully, see Section 2.3.5.

6.2.2.1 Sulphur dioxide and other sulphur compounds

The major sources of sulphur dioxide emissions are direct emissions from the sulphuric acid plant. Good extraction and sealing of the roasting installation train (roaster, calcine cooler, gas-cleaning section and sulphuric acid plant) prevents diffuse emissions.

After dedusting and cleaning, the sulphur dioxide in the gas from the sintering and roasting operations is converted to sulphur trioxide (SO₃) (see Section 2.7.1). After planned shutdowns for maintenance, during start-up and shutdown (usually every 15–20 months) there may be occasions when weak gases are emitted without conversion. These events need to be identified for individual installations, and many companies have made significant improvements to process controls to prevent or reduce these emissions [98, Lijftogt, J.A. et al 1998], [99, Hähre, S. 1998].

Improvements to process control systems have allowed more constant SO₂ concentrations to be fed to the acid plants together with caesium-doped catalysts. This and the incorporation of a fifth contact pass have resulted in very low emissions (standard practice implies four passes; five passes is considered excessive) [229, IZA plant data 2008].

During electrolysis, emissions of aerosols (sulphuric acid and zinc sulphate) take place in the cell house building. These emissions leave the cell room via the (natural) ventilation or through the cooling tower blowers (if weather conditions permit). The emissions are small compared with the emissions from the sulphuric acid plant but, as they are in the form of an aerosol, they can be dealt with in mist eliminators [98, Lijftogt, J.A. et al 1998]. Most of the plants apply coverings of the cells by adding foaming agents to the electrolyte in order to reduce/control mist formation [136, Fugleberg, S. 1999].

Sulphur dioxide production from several zinc processes is shown in Table 6.11 below.

Table 6.11: Sulphur dioxide production from several zinc processes

Process	Product	Total metal production (t/yr)	Sulphur dioxide produced (g/t of metal)
Concentrate with low iron content	Zinc + cadmium	238 800	280
Roasting and electrolysis	Zinc	65 000–482 000	200–4000
ISF and sinter plant	Zinc + lead	100 000 Zn 45 000 Pb	5000–9000
<i>Source:</i> [234, UBA (D) 2007]			

6.2.2.2 Nitrogen oxides

The roasting and smelting stages are potential sources of nitrogen oxides (NO_x). NO_x may be formed from nitrogen components that are present in the concentrates or as thermal NO_x. The sulphuric acid produced can absorb a large part of the NO_x and this can therefore affect the sulphuric acid quality. If high levels of NO_x are present after the roasting stage, treatment of the roasting gases may be necessary for product quality and environmental reasons. The range for all of the processes is 20 mg/Nm³ to 400 mg/Nm³.

6.2.2.3 Dust and metals

Dust carry-over from roasting or other pyrometallurgical processes is a potential source of direct and diffuse emissions of dust and metals. The gases are collected and treated in the gas-cleaning processes and finally in the sulphuric acid plant. Dust is removed and returned to the process.

The gases leaving splash or spray condensers in the ISF, from distillation columns and from the tapping points are also potential sources. Good extraction and abatement is needed at these points to prevent diffuse emissions. Slag treatment and quenching also gives rise to dust. The range of dust emissions from these captured sources is $< 1 \text{ mg/Nm}^3$ to 15 mg/Nm^3 .

De-aeration of vessels in the leaching and purification stages can emit aerosols. They are monitored and, if necessary, captured and treated with scrubbers or demisters. Hazardous emissions (arsane, stibane, hydrogen and cadmium), where potentially emitted, are monitored, permanently extracted and passed through abatement devices like scrubbers or demisters for wet systems and bag filters for dry systems.

Emission of aerosols takes place in the cell house and they can contain metals in solution. The range of mist and dust emissions from these sources is 0.2 mg/Nm^3 to 1.25 mg/Nm^3 .

The melting, alloying, casting and zinc dust processes are potential sources of dust and metal emissions. The range of dust emissions is reported to be 200 mg/Nm^3 to 900 mg/Nm^3 in the raw gas [98, Lijftogt, J.A. et al 1998], [99, Hähre, S. 1998]. Most often bag filters are used for off-gas and dust collection. Cleaned gas values are below 10 mg dust/Nm^3 , and often around 1 mg/Nm^3 . [99, Hähre, S. 1998].

Metals are associated with the dusts emitted, and approximately 50 % is zinc. Cadmium and lead are not present when pure zinc is melted, alloyed and cast.

While controlled emissions have known sources and can be captured and treated, diffuse emissions can evolve almost anywhere on a plant site. The main sources of diffuse emissions are material storage and handling, dust sticking to vehicles or streets, and open working areas or areas where no abatement has been performed. Mass release of metals from some European processes are given in Table 6.12. In recent years, some companies reduced their diffuse emissions efficiently by adequate measures such as [234, UBA (D) 2007]:

- renewal of off-gas collection and filter units;
- reduction of furnace downtime by improved refractory lining concept (thereby reduction of start-up and shutdown times which cause higher emissions for a limited time);
- closing/housing of delivery, material storage, and refining areas and the installation of off-gas collection systems;
- improving material handling (e.g. by wetting of bulk materials before and during loading); and reduction of transport frequencies (e.g. by use of bigger wheel loaders);
- installation of obligatory vehicle washing (for plants and external vehicles);
- reinforcement of plant areas and driveways and optimised cleaning;
- closing and decontamination of old slag disposal areas.

Table 6.12: Mass release of metals from some primary and secondary zinc plants in Europe

Process	Product	Production (tonnes)	Dust (g/t product)	Zn (g/t product)	Pb (g/t product)	Cd (g/t metal)	As (g/t metal)
Roasting, purification & electrolysis (without casting)	Zinc	130 000–1 450 000	NA	6.6–7.6	NA	< 0.05	NA
Roasting, purification & electrolysis (with casting)	Zinc or Zinc alloys	130 000–1450 000	3–17	1–15	< 0.3	< 0.05	< 0.03 as oxide
Roasting, purification & electrolysis (all process stages from concentrate with low iron content)	Zn+Cd	238 850	3	2	0.007	0.0004	< 0.00 01
Waelz process	Waelz oxide	29 000–60 000	14–73	4–21	0.3–2.0	0.13–0.42	< 0.1
Remelting, refining	Zinc	40 000	60	15	< 3	NA	NA

NB: NA = Not available.
Source: [229, IZA plant data 2008].

6.2.2.4 PCDD/F

The formation of PCDD/F in the combustion zone and in the cooling part of the off-gas treatment system (de novo synthesis) may be possible in some processes particularly if plastic components are included in the secondary materials that are fed into a process [237, UBA (A) 2004]. PCDD/F have also been detected in some dusts from Waelz kilns treating EAF dust. Without specific techniques, PCDD/F values of 100 ng/Nm³ are measured.

Due to the conversion from acidic Waelz processes to a basic slag system, a reduction of the PCDD/F concentration in the raw gas to < 0.1 ng/Nm³ can be obtained. Organic compounds can be reduced by post-combustion systems, if required.

The SDHL process can also reach very low PCDD/F values (< 0.01 ng/Nm³).

PCDD/F emissions arising from the production of cadmium from batteries are abated by the combination of afterburners and filtration techniques. PCDD/F emissions are far below 0.1 ng I-TEQ/Nm³.

6.2.3 Emissions to water

In the production of primary and secondary zinc and cadmium, metals and their compounds, and materials in suspension are the main pollutants emitted to water. The metals concerned are Zn, Cd, Pb, Cu, Ni and Co (and, to a lesser extent, Hg, Se, As and Cr) [25, OSPARCOM 1996], [98, Lijftogt, J.A. et al 1998], [99, Hähre, S. 1998], [27, M. Barry et al. 1993], [234, UBA (D) 2007].

Other significant substances that are emitted to water are chlorides, fluorides and sulphates.

The possible waste water streams that contain the aforementioned substances are:

- waste water from roasting and gas-cleaning steps: wet scrubbers, wet ESPs, the mercury removal step;
- waste water from slag granulation, if any;
- accidental spillage from various hydrometallurgical processes.

Other potential water streams are collected and reused as filter washing water (if quality allows):

- anode and cathode washing liquid effluent;
- sealing water from vacuum pumps;
- water from general operations, including cleaning of equipment, floors, etc.;
- discharge from cooling water circuits (usually following separate closed circuits);
- rainwater run-off from surfaces (in particular storage areas) and roofs;
- pumped water streams from landfills or authorised caverns.

6.2.3.1 Waste waters from abatement plants

Generally, wet gas cleaning systems operate with liquid recycling.

- Wet scrubbers after the roasting process are operated with a SO₂-saturated acidic solution. The scrubber removes fluorides, chlorides, most mercury and selenium and some particles that pass the mechanical gas treatment. To avoid the build-up of contaminants, some liquid should be bled continuously from the scrubber. Dissolved SO₂ is removed prior to further treatment.
- Wet ESPs will also produce an acidic solution. This is recycled after filtering. Some liquid should be bled from this circuit to remove build-up of contaminants. This bleed liquor is treated and analysed before discharge [98, Lijftogt, J.A. et al 1998].
- The final mercury removal step takes place, if needed, prior to the sulphuric acid plant and involves a gas-liquid contact tank or spray tower in which the liquid contains a reagent that combines with mercury and removes it. Mercury chloride (HgCl₂) is frequently used as the reagent and reacts with metallic mercury from the gas to form a solid precipitate (Hg₂Cl₂, also known as calomel). The relatively clean liquid is discharged as waste water for further treatment. The solid Hg₂Cl₂ is transformed and stabilised for final disposal.

A monitored bleed keeps suspended solids and dissolved salts within certain defined limits. The bleed is either treated separately or in an integrated water treatment plant to remove solids and dissolved species before discharge. The destination of the separated material depends on the origin of the waste water. Table 6.13 provides an indication of the composition of the gas-cleaning liquids before treatment.

Table 6.13: Typical gas-cleaning effluents before treatment

Component	Concentration (dissolved)	Composition of suspended solids
Solids		250–1500 mg/l
Sulphate	13–25 g/l	
Chloride	1.3–1.8 g/l	
Fluoride	0.3–0.5 g/l	
Mercury	0.1–9 mg/l	5–30 %
Selenium	0.1–50 mg/l	10–60 %
Arsenic	5–95 mg/l	< 0.05 %
Zinc	0.1–2.5 g/l	2–6 %
Cadmium	1–95 mg/l	
Lead	1–13 mg/l	5–50 %

Source: [99, Hähre, S. 1998]

6.2.3.2 Electrolyte bleed effluent

Electrolyte may be bled from the cells to control the build-up of impurities, e.g. magnesium, which may have a detrimental impact on the operation of the electrolytic cells. For zinc production, the flows in the electrolytic cells belong to the same (closed) water circuit as the leaching and purification stages. The sulphuric acid formed during electrolysis is fed to the leaching process and the remaining liquid is purified and fed to the electrolysis [98, Lijftogt, J.A. et al 1998], [99, Hähre, S. 1998].

The effluent bleed of the electrolytic, leaching, purification circuit is strongly acidic and contains high concentrations of zinc and suspended solids. The volume of the bleed depends greatly on the composition of the zinc concentrates that are used in the roasting. Components that tend to build up in the circuit, especially magnesium, will determine the bleed flow and the treatment required. The increasing amount of calcium in the leaching circuit, due to the use of secondary feed material, is controlled by gypsum removal from the leach liquor. A bleed from the system can be treated to remove Mg, Na, K, chlorides and fluorides [320, Huisman 2004].

6.2.3.3 Waste waters from miscellaneous sources

The electrodes used during the electrolysis need to be rinsed periodically to remove material deposited upon the surface. Manganese dioxide is formed on the surface of the anodes by the reaction of oxygen with dissolved manganese. The MnO_2 remains on the surface of the anodes, forms a sludge on the bottom of the electrolytic cells or forms a solid layer in the pipes. All these remainders are periodically removed mechanically or by high-pressure water. The manganese is separated from the rinse water for external reuse or disposal. Cathodes are cleaned after removal of the electrolytic zinc deposit. The anode and cathode washing liquid effluents are acidic and likely to contain copper, zinc, lead and suspended solids [98, Lijftogt, J.A. et al 1998], [99, Hähre, S. 1998].

Typical waste water analyses results of some processes are given in Table 6.14.

Table 6.14: Typical waste water analyses

Process	Effluent	Flow	Main components (mg/l)					COD
	(m ³ /yr)	(m ³ /h)	Pb	Cd	As	Zn	Ni	
Electrolysis	NR	40–200	0.01–0.8	0.001–0.15	0.01	0.01–1.9	NR	NR
ISP	NR	380–420	0.05–0.5	0.005–0.035	0.005–0.1	0.05–1.0	NR	NR
Waelz kiln SDHL process with washing, without crystallisation	190 000– 228 000	35	< 0.2	< 0.1	< 1.0	< 1.0	< 0.5	< 200

NB: NR = Not reported.
Source: [234, UBA (D) 2007]

If the Waelz oxide is washed, the use of crystallisation can result in an effluent-free process. Alternatively, an effluent treatment can be carried out prior to discharge.

A summary of potential waste water sources and treatment techniques is given in Table 6.15.

Table 6.15: Potential waste water sources and treatment techniques

Process unit	Operation/source	Use/treatment options
General	Rainwater from roads, yards, roofs, wet cleaning of roads, cleaning of lorries, etc.	Reuse and/or waste water treatment plant
ISF	Gas cleaning Gas-cleaning coke heating chamber	Recirculation, bleed to waste water treatment plant
Slag granulation	Wet ESP effluent Granulation water	Recirculation and cooling, bleed to waste water treatment plant
Roasting/wet gas cleaning	Wet cleaning of roaster gases	Waste water treatment plant
Leaching	General operations including wet gas cleaning	Return to leaching
Purification	General operations	Return to leaching
Electrolysis	Cleaning of cells, anodes and cathodes	Return to leaching
Cadmium leaching	Cadmium leaching	Return to Zn leaching circuit or, if not possible, to waste water treatment plant
All process units	Maintenance	Waste water treatment plant
Waste water treatment plant	Effluent treatment	Reuse for certain applications/discharge

6.2.4 Process residues

The production of metals results in the generation of several by-products, residues and wastes, which are also listed in the European List of Wastes (Commission Decision of 3 May 2000 replacing Decision 94/3/EC).

Solid residues derived from various processes and abatement stages may have one of three possible destinations:

- recycling in or upstream of the process;
- downstream treatment to recover other metals;
- final disposal after treatment to ensure safe disposal.

The following solid waste arisings are significant.

- The electrolytic production of zinc is one of the main sources of solid waste in the non-ferrous metals industry. Relatively large quantities of iron-based solids are generated by the leaching process. Jarosite and goethite are classified as hazardous waste because of the content of leachable elements such as Cd, Pb and As. Techniques are available to reduce the leachability and sometimes the permeability of the residues, such as the Jarofix process, the sulphidation process, compacting and treatment in a pyrometallurgical process.
- The leaching and purification processes and electrolysis of zinc also generate other metal-rich solids. These are usually rich in a specific metal and are recycled to the appropriate production process.
- The ISFs or direct smelting furnaces are also significant sources of solid slags. These slags have been subjected to high temperatures and generally contain low levels of leachable metals. Consequently, they may then be used as construction materials after suitable tests [289, USEPA 2008]. The Landfill Directive specifies CEN standard leaching tests for granular waste (i.e. EN 14405 and EN12457/1-4).
- Solid residues also arise as a result of the treatment of liquid effluents. The main waste streams are gypsum waste (CaSO_4) and metal hydroxides that are produced at the waste water neutralisation plant. These wastes are considered to be a cross-media effect of these treatment techniques but many are recycled to the pyrometallurgical process to recover the metals.
- Dust or sludge from the treatment of gases is used as raw material for the production of other metals, such as Ge, Ga, In and As, or can be returned to the smelter or into the leach circuit for the recovery of zinc.
- Mercury and selenium residues arise from the pretreatment of mercury or selenium streams from the gas-cleaning stage. This solid waste stream amounts to approximately 40–120 t/yr in a typical plant. Because of the restrictions in mercury use, mercury recovery from Hg-Se residues, or from calomel from the mercury removal stage, is no longer an option. Both by-products need to be stabilised for final disposal. In exceptional cases when the Se to Hg ratio is high, recovery of selenium can be an option.
- Regarding wastes generated in cadmium production from batteries, plastics from casing from dismantled industrial cells and consumer battery packs are recycled to the plastic industry. Other organic fractions are sold to the cement industry as combustible, landfilled or burnt internally with recovery of heat. Ni-Fe electrodes from dismantling industrial cells and Ni-Fe scrap from the thermal treatment are sold to the stainless steel industry.

Table 6.16 shows the use or treatment options for the residues produced by several processes.

Table 6.16: Residues from zinc processes

Production step	Product or process residue	Quantity (kg/t Zn)	Use or treatment option
RLE			
Roaster/sulphuric acid plant	Sulphuric acid	< 1200–1700	Sale
	Steam	< 1700–2000	Energy conversion
	Hg product (calomel)	< 0.1	Controlled disposal
	Hg-Se residue	0.4	Controlled disposal
	Dewatered acid sludge	< 0.5	Controlled disposal
Leaching plant	Neutral leach residue (Zn-Fe concentrate)	500	To ISF, Waelz kiln or hot acidic leach, controlled disposal
	Jarosite, Jarofix, goethite	400–600 ⁽¹⁾	Controlled disposal
		80	Controlled disposal
	Jarosite + direct leach sulphur residue	150	
	PbAg concentrate	450	Ag and Pb recovery
	Final residue if Pb-Ag concentrate removed	600	Controlled disposal or Pb/Zn smelter
Purification	Cadmium sponge	3–4	Sale or controlled disposal
	Cu cementate	7–15	Sale
	Co&Ni cementate		Sale
Cell house	Gypsum	3–4	Cement plant or controlled disposal
Waste water treatment	Precipitated sludge	7–100 ⁽²⁾	Disposal or to Pb/Zn smelter
ISF			
Sinter plant/sulphuric acid plant	Acid sludge	0.25	Controlled disposal
	Hg product	0.15	Controlled disposal
	Flue-dust	200	To Cd plant
	Sulphuric acid	1300	Sale
Cadmium plant	Cadmium carbonate	18	Sale
	Thallium sulphide	0.25	Controlled disposal
	Leach residue	180	To sinter plant
Imperial Smelting Furnace	ISF slag	600–900	Sale or controlled disposal ⁽³⁾
Waste water treatment	Precipitated sludge	30	Recycled to sinter plant
New Jersey distillation			
Liquation	Lead	15 ⁽¹⁾	To Pb refining or ISF
	Hard zinc	25–50 ⁽¹⁾	Return to ISF
As removal	Dross	< 1–5 ⁽²⁾	Return to ISF
Waste gas treatment	Flue-dust	10	Return to sinter plant
Waelz process with washing and crystallisation			
Slag granulation	Waelz slag (kg/t dry product)	1600	Construction material for road and on disposal site
Waelz oxide washing	Salt residue ⁽³⁾ (kg/t product)	130	Disposal in mines
Off-gas treatment	Adsorbent ⁽³⁾	NA	Controlled disposal
Remelting, refining			
Remelting, Refining	Hard zinc/zinc bottom dross	25	External recycling to ZnO
Off-gas treatment	Zinc ash concentrate	130	External recycling in Waelz process or ISF (if available)
Scrap sorting, melting furnace	Al-Fe scrap	50	External recycling as Al- or Fe-rich scrap
⁽¹⁾ Amount may vary with the feed. ⁽²⁾ Estimated value. ⁽³⁾ Depending on the process, quality and regulations. NB: NA = Not available.			

6.2.4.1 Leaching residues

The production of iron-based solids (goethite, jarosite or haematite) accounts for the greatest volume of waste. The amount of residues and wastes formed depends mainly on the composition of the concentrates used. Concentrates contain varying concentrations of impurities that have to be precipitated and extracted in certain process steps. Most residues are registered as transported or on-site isolated intermediates according to the REACH regulation and are used as raw materials in internal or external processes. The rest of the residues are classified as waste and disposed of after appropriate treatment (stabilisation) to landfill according to the relevant legislation. An example composition of different types of residues is shown in Table 6.17.

Table 6.17: Example compositions of different types of residues

Process	Fe (%)	Zn (%)	Pb (%)	Cu (%)	Cd (%)
Haematite (with integrated direct leaching)	65–67	< 0.2	< 0.01	< 0.02	< 0.01
Haematite (without direct leaching)	59	1	0.01	0.02	0.02
Goethite	40–42	5–9	< 2	< 0.3	< 0.1
Para-goethite	40	NA	NA	NA	NA
Conventional jarosite	20–30	2–6	0.2–6	< 0.2	0.05–0.2
Low contaminant jarosite	32	0.3	0.1	0.2	0.001
Doré jarosite	26	1	4	0.08	0.05
Jarosite/sulphur residue (40–50 % S)	9–11	2–5	8–10	< 0.4	< 0.1
NB: NA = Not available. Source: [98, Lijftogt, J.A. et al 1998], [117, Krüger, J. 1999]					

Typically, these residues account for:

- jarosite: 0.35–0.80 tonnes per tonne of zinc produced;
- goethite: 0.3–0.35 tonnes per tonne of zinc produced;
- haematite: 0.2 tonnes per tonne of zinc produced.

Haematite processes have been unable to compete in economic terms as they are significantly more complex and expensive to operate. In addition, haematite has not proved to be acceptable as a raw material in other industries.

The use of concentrates with very low iron concentrations allows the production of these residues to be avoided [227, IZA Report 2008], [240, Nyrstar Budel 2008]. However, low-iron zinc concentrates are scarce and only one plant in the EU operates with this kind of concentrates. In some cases, the process can be stopped at the neutral leach stage and the remainder of the zinc can be recovered in a Waelz kiln or a slag fuming process.

There are still some leachable metals in the slurry after filtering and washing. The residue can be treated to a less leachable form with neutralisation and sulphide treatment. The disposal of these residues can be costly as specially constructed, lined ponds or isolated areas are used to contain the material. Particular care is taken to avoid leakage and these ponds result in a major need to monitor groundwater [98, Lijftogt, J.A. et al 1998], [99, Hähre, S. 1998]. There is a significant cross-media effect compared to processes that are capable of producing an inert residue. Directive 2008/98/EC on the treatment of wastes should be taken into account when assessing the treatment or disposal requirements.

As reported in Section 6.1.2.2, leaching residues with higher amounts of zinc or lead can be treated in ISFs or Waelz kilns (Zn-Fe concentrates) and in a lead smelter (PbSO₄ concentrates). The Jarofix process is available to stabilise the residues with lime and cement [229, IZA plant data 2008] and compaction can be used to decrease the moisture content and volume of the iron residue. Pyrometallurgical treatment of these residues is also practised in Korea to produce a

non-leachable slag and recoverable metal oxides, [40, Ausmelt Ltd. 1996]. Problems with contaminant build-up have been reported. Other developments are reported in Section 6.4.

Pyrometallurgical processes can have benefits for the stability of the residue but the energy cost is much higher. This is shown in Table 6.18.

Table 6.18: Zinc refining energy consumption in function of the applied residue treatment process

		Electro- lysis	Other elect. power	Coke	Natural gas	Oil	Energy credit	Total net energy
Hydro. full ⁽¹⁾ total t Zn slabs: 5708	Average (MJ/t Zn)	12 410	2357	0	440	105	-237	15 075
Hydro. short + pyro. ⁽²⁾ total t Zn slabs: 1848	Average (MJ/t Zn)	11 700	1980	11 800	2500	1400	0	29 380
Pyro. ISF ⁽³⁾ total t Zn slabs: 700	Average (MJ/t Zn)	0	3786	38 726	12 882	0	0	55 393
⁽¹⁾ RLE including hydrometallurgical residue treatment + jarosite/goethite precipitation. ⁽²⁾ RLE until neutral leach + additional pyrometallurgical treatment of leach residue (Waelz process in most cases). ⁽³⁾ Full pyrometallurgical ISF Process. Source: [399, IZA 2012] based on Brook Hunt 2008 (ed.2009)								

6.2.4.2 Pyrometallurgical slags and residues

Slags from the ISFs, zinc fuming furnaces, and Waelz kiln processes (if EAF dust or similar feed is treated) usually contain very low concentrations of leachable metals. They are therefore generally suitable for use in construction [99, Hähre, S. 1998]. The slag output is between 10 wt-% and 70 wt-% of the metal produced, depending on the raw materials used.

A number of standard leachability tests are used by Member States and these are specific to the country in question. Processes to lower the content of entrained metals are under investigation, in order to ensure the future suitability for construction and other applications. Table 6.19 and Table 6.20 give some eluate values based on the German leaching test method DEVS4.

Table 6.19: Eluate values of granulated ISF slag

Component	Granulated ISF slag eluate (according to DEVS4) (mg/l)
Zn	0.02–0.1
Pb	0.005–0.1
As	0.001–0.02
Fe	0.05–0.2
Cu	< 0.001–0.05
pH	7–11
Source: [99, Hähre, S. 1998]	

Table 6.20: Eluate values for acidic Waelz slag

Component	Waelz slag eluate (according to DEVS4) (mg/l)
Zn	0.05
Pb	0.02
As	0.008
Cr _{tot}	0.002
Ni	0.005
Fe	0.5
Cu	0.05
F	1
Cl	5
pH	9.9
<i>Source:</i> [99, Hähre, S. 1998]	

6.3 Techniques to consider in the determination of BAT

The sections of this document entitled 'Techniques to consider in the determination of BAT' set out techniques generally considered to have the potential for achieving a high level of environmental protection in the industries within the scope of the document. The background to the way the techniques are described is given in Section 2.12 and Table 2.10.

This section presents a number of techniques for the prevention or reduction of emissions and residues as well as techniques for reducing the overall energy consumption. They are all commercially available. Examples are given in order to demonstrate techniques which illustrate a good environmental performance. The techniques that are given as examples are based on information provided by the industry, European Member States and the evaluation of the European IPPC Bureau. The general techniques described in Chapter 2 on common processes apply to a great extent to the processes in this sector and influence the manner in which the main and associated processes are controlled and operated.

6.3.1 Zinc production using primary and secondary materials

6.3.1.1 Techniques to reduce emissions from raw material reception, handling and storage

General techniques applied to reduce diffuse emissions from the reception, storage and handling of primary and secondary raw materials are considered in Chapter 2 (see Section 2.12.4.1) and in the Emissions from Storage BREF [290, COM 2006].

The techniques applied to reduce emissions during the preparation of the feed blends are considered within Section 6.3.1.2.1, as in zinc production both flows are treated in the same dust abatement systems.

Description

The technique to consider is the use of a bag filter (see Section 2.12.5.1.4).

Technical description

See Section 2.12.5.1.4.

Achieved environmental benefits

Reduction of dust emissions to air.

Environmental performance and operational data

Plant I reported data on the performance of a bag filter at these stages of the process. The range of dust values measured is 0.39–6.68 mg/Nm³, with an average value of 1.9 mg/Nm³.

A German primary zinc production plant applies a bag filter for the reduction of emissions from a silo where the roasted materials are stored. In 2005, 18 measurements were taken and the flow rate was between 2700 Nm³/h and 5340 Nm³/h. The emissions of dust and metals were:

- dust: < 0.4–0.7 mg/Nm³;
- lead: 0.002–0.011 mg/Nm³;
- nickel: < 0.001–0.003 mg/Nm³;
- zinc: 0.02–0.08 mg/Nm³.

Cross-media effects

Increase in energy use.

Technical considerations relevant to applicability

Generally applicable.

Economics

No information provided.

Driving force for implementation

No information provided.

Example plants

Plant I.

Reference literature

[385, Germany 2012], [399, IZA 2012]

6.3.1.2 Hydrometallurgical zinc production**6.3.1.2.1 Techniques to prevent and reduce emissions from the roasting of primary materials****Description**

The techniques to consider are:

- wet feed; achieved thanks to a water spraying system installed at the conveyor belt before the fluidised bed roaster;
- completely enclosed processing equipment (see Section 2.12.4);
- bag filter (see Section 2.12.5.1.4);
- hot ESP (see Section 2.12.5.1.1), with cyclones (see Section 2.12.5.1.3) as an optional previous step;
- scrubbers (see Section 2.12.5.1.6), wet ESP (see Section 2.12.5.1.2) and mercury abatement techniques (see Section 2.12.5.5).

Technical description*Bag filter*

Zinc concentrates usually have a relatively high moisture content (~ 10 %), which is quite effective at preventing dust emissions during handling, especially when completely enclosed equipment is used. In the event of dusty feed material, for example material with a very low moisture content, or for the handling of the roasted materials, bag filters are applied to abate channelled emissions from the roaster feed preparation (dosing devices, and milling and grinding when applied) and the secondary emissions from the roaster itself.

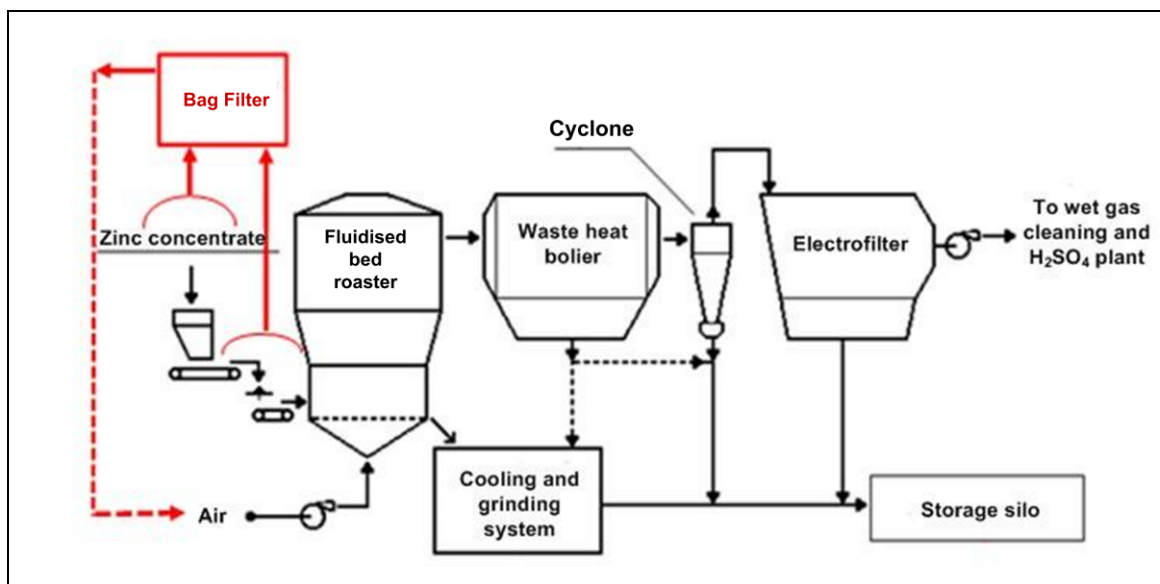

Figure 6.21: Collection and abatement of emissions from the roaster feed preparation and the roaster

Bag filters or ceramic filters achieve better dust removal efficiencies than an ESP when used at this stage of the process.

Hot ESP, with cyclones as an optional previous step

This dry cleaning stage is applied in order to recover as much dust calcine as possible. If needed, leaching of chloride or cadmium takes place before reusing the dust calcine in the process.

Scrubbers, wet ESP and mercury abatement techniques

This wet cleaning stage is applied in order to obtain an off-gas suitable for feeding into the sulphuric acid plant.

Residues from the wet ESP and mercury removal are landfilled, if they are not used for other processes. Gases with a high SO_2 content are of a fairly small volume compared to the other streams.

Achieved environmental benefits

Wet feed

- Reduction of dust emissions.
- Increase in bed stability.

Completely enclosed processing equipment

- Prevention of diffuse emissions to air.
- No loss of material.

Bag filter

- Reduction of emissions to air.
- Reuse of dust.

Hot ESP, with cyclones as an optional previous step

- Reduction of dust and volatile metals (Zn, Pb, Hg, As or Cd) emissions.
- Reuse of the dust collected in the dry part of the off-gas cleaning process, as it is chemically similar to the calcine discharged from the furnace and can be fed back into the calcine-handling system.

Scrubbers, wet ESP and mercury abatement techniques

- Reduction of dust and volatile metals (Zn, Pb, Hg, As or Cd) emissions. Besides dust removal, gas cleaning is required to obtain sulphuric acid of a commercial quality.
- Reduction of mercury emissions. When present in the feed, mercury is captured with specific equipment which may vary from site to site. Also, mercury removal is required to obtain sulphuric acid of a commercial quality.

Environmental performance and operational data*Bag filter*

Table 6.21 shows dust emissions from the feed preparation and the roaster.

Table 6.21: Dust emissions from the feed preparation and the roaster

Plant		A		A		B		H	
		Avg.	Max.	Avg.	Max.	Avg.	Max.	Avg.	Max.
Flow	Nm ³ /h	27 184	NR	10 630	NR	4 655	NR	4 000	NR
Dust	mg/Nm ³	1.04	3.1	0.54	3.1	0.21	0.51	1.6	2.6
Zn	mg/Nm ³	0.69	NR	0.35	NR	0.12	0.29	0.8	1.2
Cd	mg/Nm ³	0.0060	NR	0.0030	NR	0.0005	0.001	0.03	0.04
Pb	mg/Nm ³	NR		NR		0.0032	0.008	0.09	0.3
Applied technique		Bag filter							
Sampling frequency	number/year	0.5		0.33		1		2	
NB: NR = Not reported. Source: [378, Industrial NGOs 2012]									

A German primary zinc production plant applies a bag filter for the reduction of emissions from the mill where the roasted materials are milled. In 2005, six measurements were performed and the flow rate was 9670 Nm³/h. The emissions of dust and metals were:

- dust: 1.1–3.4 mg/Nm³;
- lead: 0.031–0.132 mg/Nm³;
- nickel: < 0.001 mg/Nm³;
- zinc: 0.7–1.7 mg/Nm³;
- arsenic: < 0.001–0.005 mg/Nm³.

Hot ESP, with cyclones as an optional previous step

Table 6.22 shows an example of dry dust abatement data in the dry cleaning stage. After dry gas cleaning, the flow enters the wet gas cleaning section.

Table 6.22: Dust removal at the dry gas cleaning section of the roasting plant (grate of ~ 120 m²) before the wet gas cleaning section

Process step (outlet)	Gas flow (max.) (Nm ³ /h)	Temperature (max.) (°C)	Dust (max.) (mg/Nm ³)
Fluidised bed roaster ↓	88 307	980	300 000
Waste heat boiler ↓	88 814	350	150 000
Cyclones (optional) ↓	89 380	350	300 00
Electrofilter	90 000	350	200

Scrubbers, wet ESP and mercury abatement techniques

Table 6.23 shows a typical example of dust abatement in the wet cleaning stage.

Table 6.23: Dust abatement in the wet gas cleaning system before conversion in the H₂SO₄ plant

Gas flow (Nm ³ /h)		Temperature (°C)		Dust (mg/Nm ³)	
In	Out	In	Out	In	Out
80 000–90 000	80 000–90 000	300–350	≤ 30	≤ 200	< 0.5

The outlet of the wet gas cleaning system is not an emission point, but an internal point inside the closed gas-cleaning circuit. An indirect indication of emissions at this point is obtained through an analysis of the sulphuric acid quality.

Mercury (total) concentration prior to filtration can range from 10 µg/m³ to 9900 µg/m³ and after filtration from 3 µg/m³ to 50 µg/m³, representing 70–99.7 % removal, depending on the mercury removal technologies employed. The subsequent quality of acid enables a mercury concentration below 1 ppm. However, the current trend in the market demands sulphuric acid with a mercury content below 0.5 ppm.

SO₂ and mist emissions from the sulphuric acid plant stack are discussed in Section 2.12.5.4.

Cross-media effects*Bag filter*

Increase in energy use.

Hot ESP, with cyclones as an optional previous step

Increase in energy use.

Scrubbers, wet ESP and Hg abatement techniques

Waste water from wet gas cleaning contains too many halogens and has to be discharged to the waste water treatment plant.

Technical considerations relevant to applicability

The wetting of the feed, enclosed processing equipment and bag filters are generally applicable.

In zinc production, the use of a hot ESP, wet ESP and mercury abatement techniques are associated with the presence of a further sulphuric acid plant.

The application of mercury abatement techniques is associated with requirements regarding the desired quality of the sulphuric acid.

Economics

Since sulphuric acid is the main by-product from zinc blende roasting, the ease and cost of transportation of the acid to end-users can be a hurdle for installing a zinc blende roasting plant with the recovery of sulphur as sulphuric acid.

Driving force for implementation

- Environmental legal requirements.
- Recovery of dust.
- Production of sulphuric acid with commercially acceptable levels of mercury.

Example plants

Generally applied in all plants in Europe running the RLE process.

Reference literature

[227, IZA Report 2008], [385, Germany 2012], [399, IZA 2012].

6.3.1.2.2 Techniques to prevent and reduce emissions from calcine processing

Description

The techniques to consider are:

- completely enclosed processing equipment (see Section 2.12.4);
- operating equipment under negative pressure (aspirating ventilator);
- bag filter (see Section 2.12.5.1.4) or scrubber.

Technical description

Bag filter (see Section 2.12.5.1.4) or scrubber

Bag filters are usually applied to treat diffuse emissions from the cooling and grinding system, calcine handling and the storage silos, as shown in Figure 6.22. Only one plant in Europe uses a scrubber instead of a bag filter for abating emissions, and in this case it is applied at the calcine milling stage.

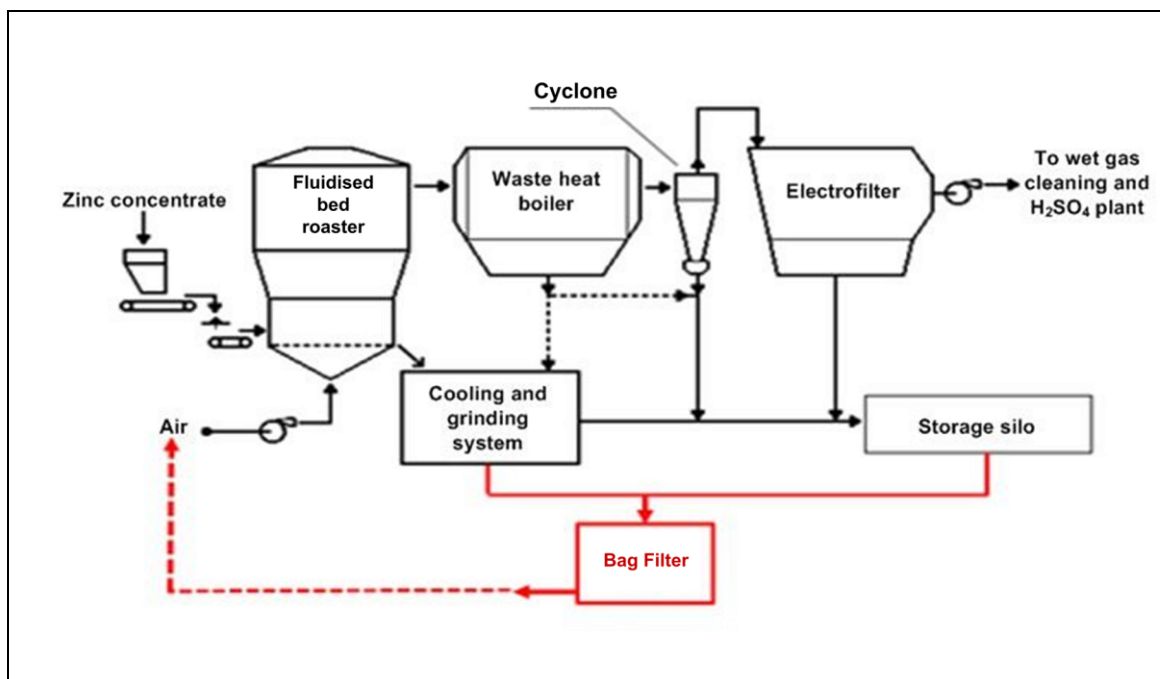

Figure 6.22: Collection and abatement of emissions from calcine processing

Achieved environmental benefits

Completely enclosed processing equipment and operating equipment under negative pressure

- Prevention of diffuse emissions to air.
- No loss of material.

Bag filter or scrubber

- Reduction of dust and volatile metals (Zn, Pb, Hg, As or Cd) emissions.
- Reuse of the calcine.

Environmental performance and operational data

Table 6.24 shows the plant-specific data for emissions during calcine milling, transport and storage.

Table 6.24: Emission data from the roasting plant during calcine milling, transport and storage

Plant		B		B		D	E		F		F		G		H
		Calcine storage and handling		Calcine milling		Calcine milling, storage and handling	Calcine milling, storage and handling		Pneumatic transport		Calcine milling		Calcine milling and storage		Calcine storage
		Avg.	Max.	Avg.	Max.	Average	Avg.	Max.	Avg.	Max.	Avg.	Max.	Avg.	Max.	Avg.
Flow	Nm ³ /h	2 972	NR	3 386		4 250	22 281		3 162		9 857		7 000		3 500
Dust	mg/Nm ³	2.16	5.40	0.54	1.35	NR	0.89	2.21	0.47	1.0	1	4.9	3.5	4.0	3.6
Zn	mg/Nm ³	1.36	3.39	0.34	0.84	0.4	0.62	1.55	0.25	0.55	0.53	2.8	NR	NR	2.15
Cd	mg/Nm ³	0.0038	0.01	0.0010	0.002	0.002	0.0007	0.002	0.0010	0.004	0.002	0.01	0.044	0.1	0.004
Pb	mg/Nm ³	0.0645	0.16	0.0162	0.04	0.02	0.0057	0.014	0.010	0.23	0.03	0.12	0.009	0.01	0.27
As	mg/Nm ³	0.0008	0.002	0.0001	0.0004	0.001	NR		NR		NR		NR		NR
Cu	mg/Nm ³	0.0092	0.023	0.0012	0.006	0.02	NR		NR		NR		NR		NR
Applied technique		Bag filter								Wet scrubber		Bag filter			
Sampling frequency	number/year	1		1		2	3		12		12		12		2
NB: NR = Not reported. Source: [378, Industrial NGOs 2012]															

Cross-media effects

- Increase in energy use.

Technical considerations relevant to applicability

Generally applied in all plants in Europe running the RLE process.

Economics

No information provided.

Driving force for implementation

- Recovery of dust.
- Occupational health.
- Environmental pollution prevention.

Example plants

Generally applied in all plants in Europe running the RLE process.

Reference literature

No reference literature provided.

6.3.1.2.3 Techniques to prevent and reduce emissions from leaching and solid-liquid separation

Description

The techniques to consider are:

- set of techniques to prevent emissions from leach tanks and settlers;
- set of techniques to prevent emissions from solid-liquid separation;
- wet scrubbers (see Section 2.12.5.2.2) with water, followed by demisters;
- centrifugal systems;
- demisters.

Technical description

Set of techniques to prevent emissions from leach tanks and settlers

- The tank must be covered with a lid to avoid diffuse emissions of aerosols. When the process requires the lid to be opened, precautions must be taken to limit emissions appropriately (e.g. extraction/negative pressure control, covers for sampling or cleaning holes, mixer shaft seals).
- If the tank is vented, the vent pipe should be connected to an abatement system (when emission levels require this).
- Use of a central mechanical draught abatement system.
- Use of a single tank abatement system, natural draught or mechanical.
- Process liquid inlet and outlet launders near the reaction tank must be covered.
- The tank itself must have a seal/sump against the ground to stop spills entering the soil.
- The tank must be located in a watertight bunded area, subject to local environmental regulations.

Set of techniques to prevent emissions from solid-liquid separation

Leaching processes normally have one or several filtering stages where solids are removed efficiently from the process liquid. For filtering iron residues, like jarosite and goethite, it is normal to use vacuum filters and rotary or horizontal moving belt systems. Several emission issues arise from this step, and this short list indicates some of the important issues.

- The vacuum pumps/blowers will normally use water as a sealant. This water will be influenced by the metal content of the tiny droplets coming from the vacuum separator

and must be strictly controlled. Malfunctioning separator stage(s) may lead to high loads of metals to the water side. It is standard practice to reuse this water and, as water will also be heated, some kind of cooling step must be added. Bleed water may need effluent treatment before it is emitted. As the water of the vacuum filters is contaminated with metals during operation, most plants use recycled process water with a low metal content for the vacuum pumps instead of fresh water. This reduces the overall water consumption.

- To maintain good, safe working conditions, it is normal to cover the vacuum filters with hoods that collect the humid air from the filtering of hot liquids. This air will contain fine droplets and could consequently be led to an abatement system, either a single unit or a collective system.
- Washing of the separated solids is important, especially if the solid material is the final residue for disposal. Horizontal belt filters allow for several washing zones, which in a countercurrent set-up will be very efficient at reducing the residual water-soluble elements. Other effective filtering devices are membrane filter presses and continuous belt pressure filters. It is common practice that heated cooling water discharged from process coolers is recycled as washing water for the filters. The washing efficiency of the filter cakes is increased when warm water is used.

Expected washing efficiencies will vary with the installation, but it is reasonable to expect water-soluble zinc below 1 % (wet basis) in jarosite.

Wet scrubbers (see Section 2.12.5.2.2), centrifugal systems and demisters for vents and chimneys

- Scrubbing with water followed by demisters, with the scrubbing water running back into the process.
- Centrifugal systems where the vent air's droplets are forced to hit the wall after being set in a circular movement by a static propeller in a double-walled reactor which collects the liquid and sends it back into the process.
- Demisters of different kinds, with collected mist and condensate flowing back into the tank along the vent wall.
- A properly designed chimney, with fluid-dynamic conditions that allow the settling of the mist, can often be sufficient to reduce mist emissions.

The requirement for abatement also depends on the local situation. Tanks located inside a poorly ventilated closed building require different abatement systems to reactors that are outside in the open air.

All the aforementioned abatement systems will normally have efficiencies of well over 95 %, according to experience. There are different problems related to scaling and clogging in all of these types and their uses. To keep these abatement facilities working properly, a preventive maintenance programme is imperative.

It is also worth mentioning that, when installing new abatement systems, care should be taken with regards to where to place the monitoring or sampling points as it is vital for good, correct sampling (to make isokinetic sampling possible).

Figure 6.23 shows a reaction tank equipped with a wave-type static demister and natural draught. It has a sealed lid and is placed in a collecting pool.

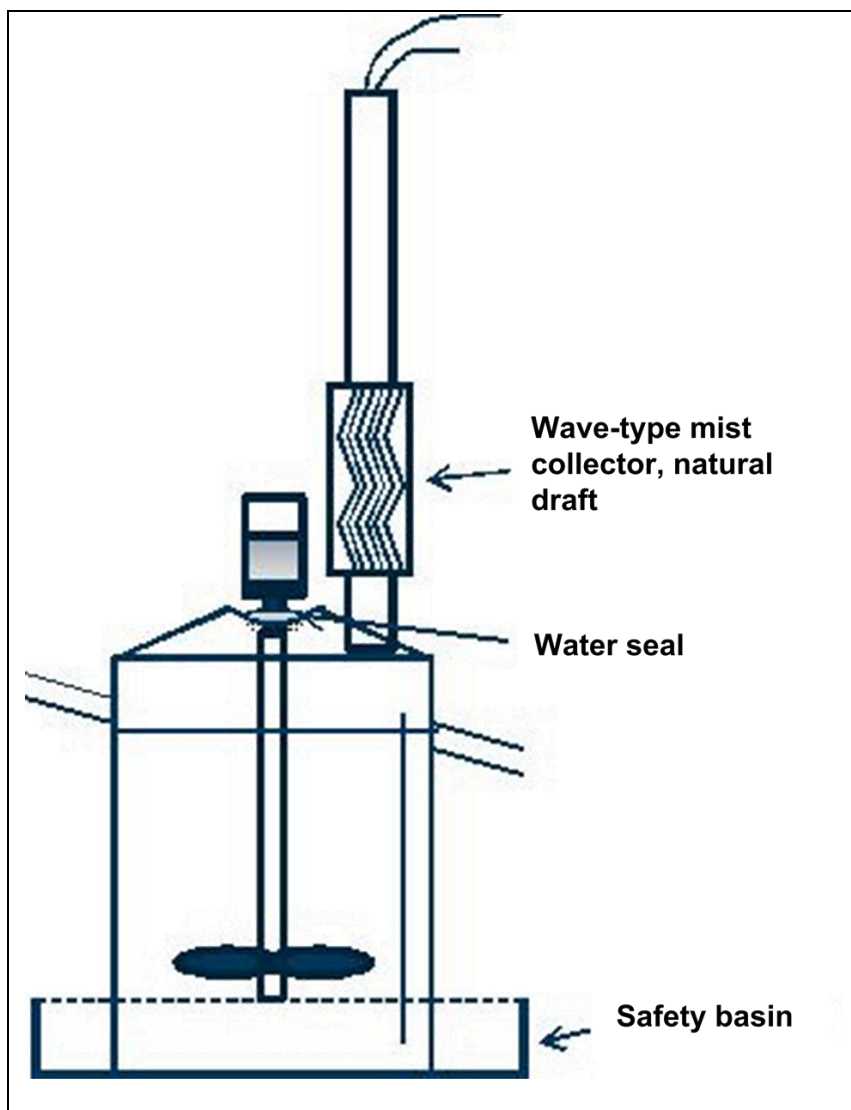

Figure 6.23: Single tank abatement system

Achieved environmental benefits

Set of techniques to prevent emissions from leach tanks and settlers and from solid-liquid separation

Prevention of aerosol and mist emissions.

Scrubbers, centrifugal systems and demisters for vents and chimneys

Reduction of aerosol and mist emissions.

Environmental performance and operational data

These installations are simple and do not require much attention, but they must be cleaned at regular intervals to keep them functioning correctly.

Central collection systems will be more complex as they normally have fans and motors incorporated, but operationally these are low-maintenance.

Centrifugal systems

No data were reported, but emissions are expected to be similar to those reported for this type of equipment in Section 6.3.1.2.4.

Scrubber and demisters

The emissions of zinc from tanks equipped as shown in Figure 6.23 above will typically be reduced by > 95 %. One example from the Boliden Odde zinc smelter with this type of installation is given: there the emissions of zinc from a settler at the neutral leach before and after installation of a mist collector were recorded during installation in 2003; the results are shown in Table 6.25.

Table 6.25: Emissions data from a settler at the neutral leach with and without a demister

	Unit	Before installation	After installation
Vent flow	Nm ³ /h	6820	3858
Zn content	µg/Nm ³	3311	264
Emission	g/h	22.6	1.0
Reduction	%		95.5
<i>Source: [378, Industrial NGOs 2012]</i>			

Plant-specific data on emissions from 2011 are given in Table 6.26, Table 6.27 and Table 6.28

[378, Industrial NGOs 2012].

Table 6.26: Emissions data from the ventilation of leach tanks

Plant		A	A	B	D	E	F	G
Flow	Nm ³ /h	12 266	17 921	42 831	11 440	17 400	40 000	12 500
Dust	mg/Nm ³	NR	NR	6.0	4.5	0.6	NR	4.5
Zn	mg/Nm ³	0.01–0.95	0.77	3.55	0.25	0.60	0.57	
Cd	mg/Nm ³	< 0.002	0.008	0.023	0.184	0.002	0.005	0.11
Pb	mg/Nm ³	< 0.03	0.031	0.168	0.194	0.025	0.030	0.009
Hg	mg/Nm ³	NR	NR	NR	0.03	NR	NR	NR
As	mg/Nm ³	NR	0.022	0.002	0.019	NR	NR	NR
Cu	mg/Nm ³	NR	NR	0.024	0.21	0.006	NR	NR
Ni	mg/Nm ³	NR	NR	0.0004	0.17	NR	NR	NR
Applied technique		Demister	Control valve to control the flow	None	Scrubber	None	Scrubber	None
Sampling frequency	number/year	1.00	0.5	1	0.2–2	3	12	3
NB: When no emission abatement system is applied, this means there is no abatement on the emission flow. However, in most cases, precautions are taken to avoid or minimise emission flows. For Plants B and E, the emissions data include emissions from the purification section. NR = Not reported.								

Table 6.27: Emissions data from the direct leach

Flow	Nm ³ /h	9 640
Zn	mg/Nm ³	0.61
Cd	mg/Nm ³	0.024
Pb	mg/Nm ³	0.033
As	mg/Nm ³	0.025
Hg	mg/Nm ³	0.008
Applied technique		Scrubber
Sampling frequency	number/year	0.5

Table 6.28: Emissions data from the jarosite process in Plant A

Flow	Nm ³ /h	8 614
Zn	mg/Nm ³	0.25
Cd	mg/Nm ³	0.023
As	mg/Nm ³	0.029
Applied technique		None
Sampling frequency	number/year	0.2

Cross-media effects

Increase in electricity consumption (fans).

Economics

On the air side, the installation of these techniques is relatively low-cost.

For the water/liquid side, it is expensive to build systems to prevent spillages onto the ground. This means installing an extensive infrastructure for the collection of surface run-off waters.

Driving force for implementation

- Reduction of emissions to air.
- For plants where the leaching and purification operations take place indoors, there is an additional need to extract vapours to maintain a healthy workplace. This is typically the case in plants in northern Europe with cold winters.
- Prevention of leakage into the soil.

Example plants

Generally applied in all plants in Europe running the RLE process.

Reference literature

No reference literature provided.

6.3.1.2.4 Techniques to prevent and reduce emissions from solution purification using zinc powder and chemical additives

Description

The techniques to consider are:

- set of techniques to prevent emissions from reaction tanks and settlers;
- wet scrubbers (see Section 2.12.5.2.2) with water or chemicals like KMnO₄/diluted H₂SO₄ followed by demisters;
- centrifugal systems;

- demisters.

Technical description

The purification reactions take place in tanks/settlers/filters and have the same types of emissions issues as leaching. In general terms, abatement techniques used in leaching can also be applied to purification, although special precautions must be taken to avoid problems related to the evolution of H₂ gas (hydrogen), SbH₃ (stibane) and AsH₃ (arsane). For this, reaction tanks must be well vented to allow enough air into the off-gas to dilute the hydrogen to below 4 % of the LEL.

Set of techniques to prevent emissions from reaction tanks and settlers

In this context, settlers and reaction tanks are considered together. To prevent emissions from reaction tanks, the following basic points need to be considered.

- The tank must be covered with a lid to avoid diffuse emissions of aerosols.
- If the tank is vented, the vent pipe can be connected to an abatement system.
- Use of a central mechanical draught abatement system (with redundancy if connecting many tanks).
- Use of a single tank abatement system, natural draught or mechanical.
- Process liquid inlet and outlet launders must be covered.
- The tank itself must have a seal against the ground to stop spills entering the soil.
- The tank must have a safety basin around it with enough space to hold a full tank in the event of a tank breach. If several tanks are together in a battery, the basin must hold at least the volume of one tank.

Wet scrubbers (see Section 2.12.5.2.2), centrifugal systems and demisters

- Scrubbing with water or chemicals such as KMnO₄/diluted H₂SO₄ followed by mist collectors (demisters), with the scrubbing water running back into the process or treated separately.
- Centrifugal systems where the vent air's droplets are forced to hit the wall after being set in a circular movement by a static propeller in a double-walled reactor which collects the liquid and sends it back into the process.
- Demisters of different kinds, with collected mist and condensate flowing back into the tank along the vent wall.

All the aforementioned abatement systems will normally have efficiencies of well over 95 %, according to experience. There are different problems related to scaling and clogging in all of these types and their uses. To keep these abatement facilities working properly, a preventive maintenance programme is imperative.

Redundancy is important for maintenance to always keep H₂ under control. In addition, fans are connected to an emergency power source so that in the event of a power failure the fans will still work. The mist collectors are usually of the wave variety.

It is also worth mentioning that, when installing new abatement systems, care should be taken with regards to where to place the monitoring or sampling points as it is vital for good, correct sampling (to make ISO kinetic sampling possible).

The purification section at Plant D is equipped, as shown in Figure 6.24, with a central redundant abatement system.

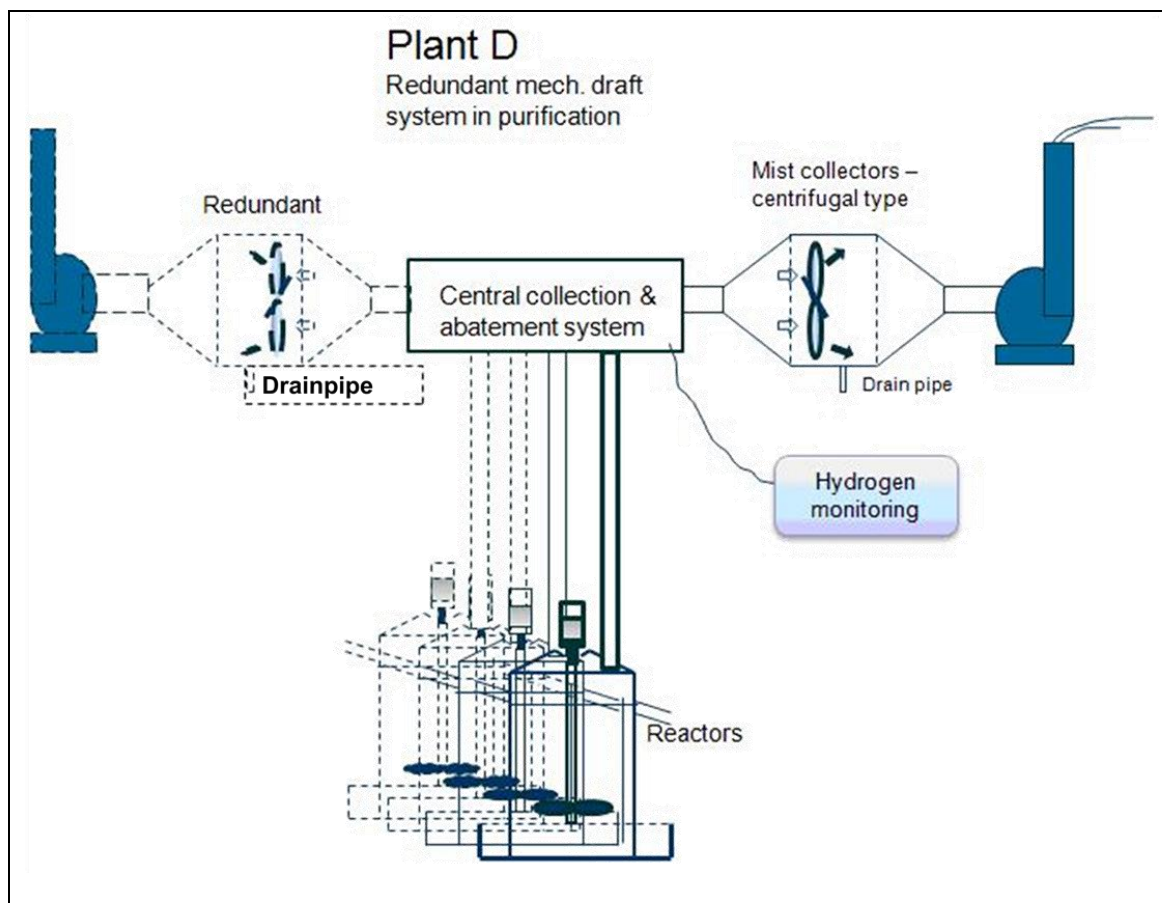

Figure 6.24: Central abatement system with centrifugal-type mist collector

Achieved environmental benefits

Reduction of emissions to air.

Environmental performance and operational data

Operations are mostly conducted in continuous mode at 60–90 °C (using the waste steam from the roaster), with controlled additions of zinc powder.

These installations are simple and do not require much attention, but they must be cleaned at regular intervals to maintain their function.

Central collection systems will be more complex as they normally have fans and motors incorporated, but operationally these are low-maintenance.

Plant-specific emissions data are given in Table 6.29. Plant D installed a complete, new purification process in 2004 using state-of-the-art technology. Other plants have older infrastructure.

Table 6.29: Emissions data from the purification process

Plant		A		A		D		F	
		Avg.	Max.	Avg.	Max.	Avg.	Avg.	Max.	
Flow	Nm ³ /h	5 488	NR	16 715	NR	13 850	31 000	NR	
Zn	mg/Nm ³	0.07	0.52	0.1	2.78	0.12	0.81	3.1	
Cd	mg/Nm ³	0.01	0.043	0.012	0.04	< 0.001	0.005	0.018	
Pb	mg/Nm ³	NR	NR	NR	0.177	NR	0.01	0.11	
As	mg/Nm ³	0.015	0.043	0.01	0.3	NR	NR	NR	
As(ox)	mg/Nm ³	NR	NR	NR	NR	NR	0.002	0.004	
AsH ₃	mg/Nm ³	NR	NR	NR	NR	NR	0.23	0.48	
Applied technique		Demister		Scrubber		Centrifugal system		Scrubber	
Sampling frequency	number /year	0.5		0.5		0.5		12	
Process step		Cu & Cd precipitation		Co precipitation		Co precipitation		Whole purification process	
NB: NR = Not reported. Source: [378, Industrial NGOs 2012]									

Only Plant B reported emissions for antimony. Data reported (average of 0.0012 mg/Nm³ and maximum of 0.0020 mg/Nm³) correspond to mixed gas streams, and the reported antimony concentration is not only stibane but a mix of fine droplets of solution and fine entrained antimony tartrate dust which is added in the purification. The total annual emission of antimony is 0.44 kg.

Plant-specific emissions data from atmospheric coolers are given in Table 6.30.

Table 6.30: Emissions data from atmospheric coolers in the purification process

Plant		A		A		B		E	
		Avg.	Max.	Avg.	Max.	Avg.	Max.	Avg.	Max.
Flow	1000 Nm ³ /h	392		220	NR	415	NR	752	NR
Zn	mg/Nm ³	0.07		0.05	0.11	0.38	1.89	0.61	1.53
Cd	mg/Nm ³	0.01		NR		NR		NR	
Total salts	mg/Nm ³	NR		NR		0.93	4.66	1.5	3.75
SO ₄	mg/Nm ³	NR		NR		NR		0.9	2.25
Applied technique		Demister							
Sampling frequency	number/year	0.33		0.2		1		1	
NR = Not reported. Source: [378, Industrial NGOs 2012]									

Cross-media effects

Increase in electricity consumption (fans).

Technical considerations relevant to applicability

Generally applicable.

Economics

On the air side, the installation of these techniques is relatively low-cost.

For the water/liquid side, it is expensive to build systems to prevent spillages onto the ground. This means installing an extensive infrastructure for the collection of surface run-off waters.

Driving force for implementation

- Reduction of emissions to air.
- Avoidance of explosion hazards related to high H₂ concentrations.

Example plants

- Demisters: Plants A (As-based process) and D (Sb-based process).
- Scrubbers: Plants A (As-based process) and F (As-based process).

Reference literature

[136, Fugleberg, S. 1999], [234, UBA (D) 2007], [274, COM 2008]

6.3.1.2.5 Techniques to prevent and reduce emissions from electrolysis

6.3.1.2.5.1 Techniques to prevent and reduce emissions from electrolysis coolers

Description

The technique to consider is the use of a demister.

Technical description

Heat is produced during the electrolytic process, resulting in an increase in the zinc sulphate solution temperature. This heat must be partially removed, which is done in a cooling circuit. This can be designed to simultaneously optimise the water balance of the process. In this case, cooling of the purified solution and evaporation of water are combined, usually by means of atmospheric cooling towers. To reduce mist emissions from this operation, the cooling towers are equipped with demisters.

Achieved environmental benefits

- Reduction of mist emissions containing metals (mainly zinc) and sulphate to air.
- Recycling of all liquid from the captured mist to the process.

Environmental performance and operational data

The performance of a demister in a cooling tower with regards to mist elimination depends on the velocity of the gas stream, the mist size distribution, the type of demister pad (structure and material), its total thickness (thickness per layer and number of layers), the volume and distribution of sprayed liquid and the cleanliness of the pad (degree of clogging due to deposition of gypsum).

Moreover, the design and choice of these parameters are complicated by the fact that the working regime of the atmospheric cooling tower can vary significantly due to climate and seasonal differences (air temperature and humidity) and because of variations in the temperature of the zinc sulphate solution to be cooled (30–40 °C), which depends on the regime of the electrolytic process (e.g. the applied current density).

Table 6.31 shows plant-specific emissions data from 2011 with atmospheric cooling.

Table 6.31: Emissions data from atmospheric cooling of the electrolyte

Plant		A		B		D	E		F		G
Flow (average)	$10^3 \text{ N m}^3/\text{h}$	2 284		2 791		3 948	2 668		2 000		480
		Avg.	Max.	Avg.	Max.	Avg.	Avg.	Max.	Avg.	Max.	NA
Zn	mg/N m^3	0.050	0.52	0.034	0.678	0.086	0.210	0.53	0.030	0.05	NA
Applied technique		Demister									
Sampling frequency	number/year	0.5		1		0.2	1		12		0
<p>NB: In Plants B and E, a different sampling technique is used to measure emissions from the atmospheric coolers. As both plants have similar equipment, it could be that the differences are related to the sampling technique. Measuring the emissions from cooling towers is complex and not standardised. Gas flow measurements and sampling methods for point sources are not readily applicable for cooling tower emissions because typical distance rules that are valid for guided emissions cannot be used as there is no stack present. The diffuse emission originates from a surface of several tens of square metres, with important variations in flow rate and mist concentration in function of the location above the demister. Good practice in order to obtain representative emissions data is to characterise this distribution of flow rates and mist concentrations by measuring the local gas velocity and taking gas samples at several points across the section.</p> <p>NA = Not applicable.</p> <p>Source: [378, Industrial NGOs 2012]</p>											

Because gypsum is deposited inside the cooling tower, including on the demisters, frequent cleaning of the towers is required to guarantee efficient cooling and mist elimination. At regular intervals, one of the towers is temporarily taken out of service and build-ups of gypsum are removed by high-pressure water jetting or manually. The volume of gypsum-rich waste material recovered from cleaning the cooling towers depends on the calcium content of the plant's feed material and on whether or not other gypsum bleeding steps are installed in the hydrometallurgical part of the process.

With properly maintained cooling towers and well-designed demisters, emission levels for mists in the range of 1–3.5 mg/Nm³ are achievable (approximately and assuming a mist composition similar to the one of the electrolyte, total mist is seven times the zinc concentration).

Cross-media effects

One cross-media effect is an increase in energy use. In general, the demisting performance improves as the demister thickness is increased and its structure becomes less permeable, and at the same time the pressure drop over the demister increases (for a constant flow). A higher pressure drop means a higher energy consumption for the cooling tower fans. Also, it is possible that the structural stability and the construction material of the cooling tower itself impose a maximum level for the pressure that can be applied.

Other cross-media effects are an increase in water consumption and the generation of waste water and solid waste. Frequent cleaning of the towers is required to guarantee efficient cooling and mist elimination. These operations require the use of water and create waste waters and solid waste (gypsum). Whether the waste water can be totally or partially recycled to the main zinc sulphate circuit or needs to be sent to the central waste water treatment plant depends on the plant's total water balance. The gypsum-rich material is separated from the washing water locally at the electrolysis section (e.g. by settling, filtering) and leaves the circuit as a separate waste stream or it is not separated locally. In that case, the gypsum (as a cake or as a slurry) is sent to the central waste water treatment plant (WWTP) and the gypsum particles may be part of the WWTP sludge, or it may be sent to the leaching section if a calcium bleed step is available in the process.

Technical considerations relevant to applicability

Changing the type of demister or adding a layer in an existing cooling tower can result in technical restrictions related to limited structural stability/strength, accessibility and fan capacity.

Economics

For new cooling towers, the installation of demisters is standard practice and its price is incorporated into the tower's total investment cost.

Replacing a demister with another type or installing an additional demister layer in existing atmospheric cooling towers implies:

- investment costs;
- modifications in structure, supplies, etc. which will require the installation of new/additional demister pads (strongly dependent on the local situation);
- the need to upgrade/renew fans (strongly dependent on the local situation);
- increased operating costs (mainly additional electricity cost due to increased pressure drop).

Driving force for implementation

Reduction of mist emissions containing metals (mainly zinc) and sulphate to air.

Example plants

The use of atmospheric coolers and demisters is common practice worldwide for zinc producers using the RLE process.

Reference literature

No reference literature provided.

6.3.1.2.5.2 Techniques to prevent and reduce mists from electrowinning inside the cell house

Description

The techniques to consider are:

- proper ventilation of the cell house;
- use of additives, especially foaming agents, to minimise the formation of mists.

Technical description

Proper ventilation of the cell house

To further protect the workplace atmosphere, the cell house building is ventilated. Two systems exist and are generally accepted for the collection of electrolyte mist.

- Non-combined: the cell house is ventilated (forced or natural draught) independently from the electrolyte cooling; the cooling towers make use of air from outside the building.
- Combined: the cell house is ventilated by the atmospheric cooling towers, the air from the building is used as a cooling agent in the coolers. The ventilation air thus passes the cooling towers' demisters and the acid mist is recovered.

Use of additives, especially foaming agents

Additives, especially foaming agents, e.g. liquorice, are used to minimise the formation of mists. Maintaining a relatively stable foam layer on the surface of the solution in the electrolytic cells prevents the oxygen bubbles formed at the anodes from bursting at the surface with an excessive splash of small liquid particles into the air.

Achieved environmental benefits

- Safeguarding of the workplace atmosphere inside the building, with limited mist exposure for the operators.
- Significant reduction in the creation of acid mist at the electrolytic cells, due to the use of additives, especially foaming agents.
- Reduction of mist emissions.

Environmental performance and operational data

Emissions data from ventilation of the cell house building are reported in Table 6.32.

Table 6.32: Emissions data from ventilation of the cell house building

Plant		A	B	D & E	F
Flow	Nm ³ /h	1 600 000	1 200 000	Via coolers	803 439
Zn	mg/Nm ³	0.2	0.04		0.04
SO ₃		NR	0.14		NR
H ₂ SO ₄		NR	NR		0.29
Applied technique		None	None		None
Sampling frequency	number/year	0.5	1		12
NB: NR = Not reported. Source: [378, Industrial NGOs 2012]					

The use of foaming agents such as liquorice and the ventilation of the cell house building permit a sulphuric acid mist concentration in the workplace atmosphere of below 0.5 mg/m³ (8-hour time-weighted average).

Cross-media effects

Proper ventilation of the cell house

Increase in electricity consumption.

Use of additives, especially foaming agents

Increase in the consumption of additives (e.g. liquorice). This increase is low.

Technical considerations relevant to applicability

Generally applicable.

Economics

The addition of foam-stabilising additives implies higher investment costs (storage, handling, preparation, and dosing equipment) and operational costs (mainly reagent costs).

Driving force for implementation

- Reduction of mist emissions containing metals (mainly zinc) and sulphate to air.
- Reduction of operators' exposure to acid mist.

Example plants

The addition of foam stabilisers in the electrolytic process and cell house ventilation are commonly applied worldwide by zinc producers using the RLE process.

Plants applying these techniques: Plants A, B (non-combined ventilation), C, D, E (combined ventilation), F, G and H.

Reference literature

No reference literature provided.

6.3.1.2.5.3 Techniques to prevent and reduce waste water from the cell house

Description

The technique to consider is the use of a secondary containment system.

Technical description

Cell houses are equipped with an extensive secondary containment system to recover all spills and liquids or slurries from cleaning operations. In principle, all collected solutions and solids are returned to the leaching stage.

Achieved environmental benefits

All spills and liquids or slurries from cleaning operations are collected in a secondary containment system and are maximally returned to the leaching step. Only in exceptional circumstances, e.g. during significant maintenance works or periods when the overall water balance does not allow all the diluted solution collected to enter the main zinc solution circuit, is a part of the collected solution sent to the central waste water treatment plant.

Environmental performance and operational data

No information provided.

Cross-media effects

No information provided.

Technical considerations relevant to applicability

No information provided.

Economics

Investment is required for containment systems, intermediate storage tanks and recycling circuitry. There are also costs associated with a central waste water treatment plant, see Section 6.3.4.

Driving force for implementation

- Reduction of waste water to be treated in the central waste water treatment plant.
- Overall zinc yield of the plant.

Example plants

Plants with electrolysis in DE, FR, BE, SP, FI, BG, N, PL and NL.

Reference literature

No reference literature provided.

6.3.1.2.6 Techniques to prevent waste water from hydrometallurgical zinc production

Description

Closed loop system with maximum internal recycling of water-rich streams.

Technical description

The RLE process is principally a closed loop system with regards to the sulphate solution: the sulphuric acid formed during electrolysis is returned to the leaching stage, where it is used to dissolve zinc and other elements from the calcine; the zinc sulphate solution is then purified and fed to the electrolytic process. Hence, sulphates and water are not consumed in the hydrometallurgical reactions, but are reused systematically. This closed loop system is the most important way to prevent waste water streams.

However, in practice, the water balance of the plant needs to be constantly safeguarded. On one hand, part of the water disappears from the circuit through evaporation from tanks and settlers and in the cooling towers, and as moisture entrained in by-products and wastes (e.g. filter cakes such as copper cement, lead- and silver-containing leach residues, iron residues), and possibly from specific bleeding operations for impurities. On the other hand, water also enters the circuit, such as rainwater, water for filter cake washing, water for cleaning operations (e.g. periodic anode and cathode cleaning) and water for pump sealing.

In order to recover metals and sulphates and to unburden the WWTP, the standard approach for a RLE plant is to recycle metal- and sulphate-containing waters from cleaning operations, filter cake washing, etc. to the overall process solution circuit:

- to the maximum extent that the plant's water balance allows (volume-wise);
- as long as the composition of the water does not cause unacceptable chemical problems or risks in the hydrometallurgical process.

In this context, waste water streams containing organic compounds (e.g. contaminated with oil) are generally considered unsuitable for recycling because organic compounds can have a detrimental impact on the purification or the electrolytic process. Also, waters containing high concentrations of halogens (Cl, F, Br) or (earth) alkali metals (Na, K, Mg) are not recyclable to the main circuit, or only to a limited extent, because these impurities have the tendency to build up in the process and/or can cause chemical/technical problems in the electrolytic process (e.g. chloride-linked corrosion of the aluminium cathodes, formation of toxic chlorine gas at the anodes) or in other parts of the hydrometallurgical process. These waste water streams are sent directly to the WWTP.

Dry solid materials from spills and cleaning operations in the roasting and casting sections (e.g. roaster feed material, calcine, flue-dust, dross) are kept dry if possible when recycling in the roasting section is foreseen; if recycled in the leaching and purification section, water can be used to as long as the water balance allows it.

Apart from the principal zinc sulphate circuit, the uses of the main liquid effluents arising from the RLE process are listed in Table 6.33 below.

Table 6.33: Use options for liquid effluent flows from the RLE process

Process	Operation/source	Use options
Roaster - Acid plant	Wet gas cleaning of roaster gases	To waste water treatment plant (WWTP) (containing halogens)
	Bleed from boiler and closed cooling water circuits	To wet gas cleaning or leaching (main zinc sulphate circuit)
	Cleaning operations/spills	To leaching (main zinc sulphate circuit)
Leaching - Purification	Cleaning operations/spills	To leaching and/or purification (main zinc sulphate circuit)
	Filter cake washing	To leaching and/or purification (main zinc sulphate circuit)
	Wet gas scrubbing	To leaching and/or purification (main zinc sulphate circuit) in the case of non-alkaline scrubbing or to WWTP in the case of alkaline scrubbing (containing (earth) alkali metals)
	Magnesium bleed step	To waste water treatment plant (WWTP) (containing (earth) alkali metals)
	Ponds	To leaching (main zinc sulphate circuit)
Electrolysis	Cleaning of anodes and cathodes	To leaching (main zinc sulphate circuit)
	Other cleaning operations	To leaching (main zinc sulphate circuit)
Casting	Cleaning operations/spills	To leaching (main zinc sulphate circuit)

Depending on their quality, some water streams from certain operations can be used for another purpose, so the intake of more fresh water can be avoided and/or the net flow to the WWTP is lowered.

A few examples of concrete applications can be given: water from indirect cooling operations (e.g. calcine cooling drum, casting moulds) or collected contaminated rainwater or water from groundwater/soil remediation operations can be used for filter cake washing, as pump sealing water, for making up boiler water or for cleaning operations. If the (earth) alkali metal concentrations (hardness) and halogen concentrations in a water stream are low it may be used for cooling purposes.

The reuse of the WWTP's effluent is usually limited or impossible because of elevated levels of halogens and (earth) alkali metals.

Achieved environmental benefits

- Recovery of metals and sulphates.
- Reduction of water use.
- Lightening of the WWTP load (decreased waste generation, decreased energy and reagent use and decreased emissions).

Environmental performance and operational data

The degree to which a plant is able to reuse certain water-rich streams and the technical and environmental characteristics for that are so site-specific that only an evaluation on a case-by-case basis is meaningful. No data are available.

Cross-media effects

- Increased risk of failure of the zinc winning process (with possible negative environmental and/or safety consequences).

- Depending on the overall water balance, recycling water-rich streams into the main process circuit can increase the energy consumption, especially if excess water needs to be evaporated.
- In particular cases, e.g. when (slightly) contaminated water is used to replace fresh water for the preparation of demineralised water, the reagents and/or energy consumption for that operation may increase.

Technical considerations relevant to applicability

All RLE-based plants make use of the closed loop system with regard to the sulphate solution.

A plant's possibilities and restrictions with regards to the reuse of certain water-rich streams are site- and region-specific. They depend on the following:

- the overall water balance, which itself is influenced by climatic and seasonal conditions (which largely determine the evaporation and cooling performances) and process and market conditions (e.g. the presence/absence of a bleed step (e.g. magnesium bleed operation, sales of purified solution));
- the plant's layout (e.g. distance between the process step where a stream is/can be made available and the place where that stream may potentially be used);
- the levels of impurities across the process, such as halogens and (earth) alkali metals, which depend to a large extent on the plant's feed composition (especially the relative amount of secondary feed material) and on the presence/absence of specific bleeding operations (e.g. gypsum removal step, chlorine removal step, magnesium bleed).

Economics

As a plant's possibilities to reuse certain water-rich streams, as well as its technical design, are very site-specific, a project's economics must be evaluated on a case-by-case basis. No data are available.

Driving force for implementation

- Increased recovery yields for metals and sulphates.
- Reduction of overall fresh water use.
- Lightening of the WWTP load (decreased waste generation, decreased energy and reagent use and decreased emissions).

Example plants

All European plants that use the RLE process (Plants A, B, C, D, E, F, G and H).

Reference literature

No reference literature provided.

6.3.1.2.7 Techniques to prevent and minimise residues and wastes from hydrometallurgical zinc production

Description

Recycling or reuse of residues and wastes from hydrometallurgical zinc production.

Technical description

Concentrates contain impurities that are removed and precipitated in further process steps in the form of solid material (e.g. dust), liquid or sludge. Concentrate treatment may cause some dust residues that are recycled and mixed with concentrates. When dust is too fine, a pretreatment such as micropelletising may be required. None of the residues produced in this process need special treatment. The roasting process is almost entirely enclosed. Due to the enclosure, process residues and waste flows are minimised.

Mercury is removed from the roasting gas and a mercury-containing residue is precipitated. This residue is mixed in weak acid and is separated by filtration. After separation, this residue can be stabilised and disposed of. Alternatively, this residue can be treated further by distillation to produce pure metallic mercury. In the Boliden-Norzink process, a saleable metallic mercury is produced if electrowinning is included. If electrowinning is not included, stable mercury compounds can be discarded via secure disposal. None of the EU-28 zinc smelters using the Boliden-Norzink process produce metallic mercury by electrowinning; mercury produced in the NFM process is classified as waste and has to be stabilised and disposed of according to valid legislation (e.g. landfill or salt mine). The volume of produced mercury-containing waste can be decreased significantly by distillation.

The amount of removed mercury is fully dependent on the mercury concentration range in the raw material. A typical range may be 0.2–0.6 kg/t Zn (residue after filtration) or 0.05–0.2 kg/t Zn of pure distilled metallic mercury.

Residues formed in the hydrometallurgical leaching and purification route are precipitated in different process steps. The amount of precipitates depends mainly on the quality of the concentrates and the efficiency of the precipitation. One of the main residue fractions in the hydrometallurgical process route is iron residue (in the form of jarosite or goethite). Iron residue is mainly disposed of to landfill according to valid legislation (landfill regulation, environmental permit). The amount of iron residue produced is partially dependent on the precipitate type (goethite or jarosite), but more significantly dependent on the iron concentration in the concentrates. There are no techniques to minimise this amount. Low-iron concentrates may be used to avoid iron residue, but the availability of this type of concentrate is very limited. In the EU, there is only one plant which exclusively processes low-iron concentrates. To ensure this, it has signed long-term contracts with a large mine that has low-iron concentrates: the Century mine in Australia. Since the Century mine is close to depletion, it will become very difficult in the future to operate a zinc refinery exclusively on low-iron concentrates.

Elements other than zinc present in the plant feed need to be extracted and removed in order to achieve a pure zinc product and to avoid a build-up of such elements in the closed hydrometallurgical circuit. Some of those extracted elements are concentrated in saleable 'on-site isolated or transported intermediates' and are registered according to REACH. Such extracted elements or by-products are:

- copper (Cu) in a copper cement;
- cobalt-nickel (Co-Ni) in a Co-Ni cement;
- cadmium in a cadmium cake, sometimes further refined in-house and marketed as cadmium sticks (see section 6.1.4.1); alternatively Cd can be disposed of in a secure deposit in accordance with legislation;
- lead and silver in a PbSO_4 -Ag intermediate or Pb residue, etc.;
- manganese in Mn sludge (after internal recycling);
- zinc dross (after internal recycling);
- other specific 'intermediates', which, if isolated, can offer recovery and exploitation possibilities for elements like germanium, indium and gallium.

Other process residues need to be minimised, inertised and landfilled, internally or externally:

- gas-cleaning sludge, e.g. containing some lead, selenium and mercury;
- iron residues, optionally including a direct leaching process residue;
- gypsum removal stage residue;
- neutralisation sludge from the waste water treatment plant (WWTP).

Achieved environmental benefits

- Maximisation of saleable 'intermediates' to be treated and exploited internally/externally.
- Minimisation of wastes that need to be made inert and landfilled.

Environmental and operational data

Typical waste flows and residues formed in the hydrometallurgical zinc process and treatment are shown in Table 6.34.

Table 6.34: Typical waste flows and residues formed in the hydrometallurgical zinc process and treatment

Residue/Waste	Process where formed	Amount (kg/t Zn)	Further treatment options
Dust from concentrate storage and handling	Concentrate handling	NR	Recycling in the process with concentrate feed
Dust from roasting process	Roasting process dry gas cleaning	NR	It passes through the ball mill and is then added to the calcine silos together with the calcine overflow from the roaster
Mercury-containing residue (after filtration)	Hg removal (gas-cleaning section)	0.3–0.6	Stabilisation and final disposal to landfill, to a secure deposit or to a salt mine according to valid landfill regulation. The Boliden-Norzink process including EW produces a saleable product
Purified metallic mercury (after distillation)	Distillation after Hg removal	0.05–0.2	Stabilisation and final disposal to landfill, to a secure deposit or to a salt mine according to valid landfill regulation
Lead- and silver-containing residue	Leaching	0.3–0.5	Registered as a transported intermediate according to the REACH regulation. Recycled as raw material by an external plant. Can also be disposed of to landfill or to a salt mine according to valid legislation
Cu residue	Solution purification	9–13	Registered as a transported intermediate according to the REACH regulation. Recycled as raw material by an external plant. Saleable by-product.
Co-containing residue	Solution purification	3–7	Registered as a transported intermediate according to the REACH regulation. Recycled as raw material by an external plant. Saleable by-product.
Cd residue	Solution purification	2–4	Registered as a transported intermediate according to the REACH regulation. Recycled as raw material by an external plant. Saleable by-product. Can also be disposed of to landfill or in a secure deposit according to legislation
Mn sludge	Electrowinning/solution purification	3–6	Registered as a transported intermediate according to the REACH regulation. Recycled as raw material by an external plant. Saleable by-product. Can also be disposed of to landfill or in a secure deposit according to legislation
Gypsum sludge	Electrowinning/solution purification	2–6	Registered as a transported intermediate according to the REACH regulation. Recycled as raw material by an external plant. Saleable by-product. Can also be disposed of to landfill or in a secure deposit according to legislation

NB: NR=not reported

Cross-media effects

- Use of chemicals for precipitation (e.g. Zn powder, $\text{Ca}(\text{OH})_2$, NaOH, Na_2S , NaHS, CuSO_4).
- Increase in energy use.

Technical considerations relevant to applicability

In principle this technique is applicable everywhere, but it is strongly dependent on local conditions (e.g. marine environment, or for an inland plant situated on a big river or a small creek the plant feed is key).

Economics

No information provided.

Driving force for implementation

- Sustainability of the plant operations.
- Reuse of natural resources.

Example plants

All European plants that use the RLE process (Plants A, B, C, D, E, F, G and H).

Reference literature

No reference literature provided.

6.3.1.2.8 Techniques to improve the disposal of leaching residues from hydrometallurgical zinc production

6.3.1.2.8.1 Pyrometallurgical treatment to improve the disposal of leaching residues from hydrometallurgical zinc production

Description

Pyrometallurgical treatment in the Waelz kiln. Using this technique involves implementing complementary air emissions abatement techniques like bag filters (see Section 2.12.5.1.4) and wet scrubbers (see Section 2.12.5.1.6).

Technical description

The Waelz process for pyrometallurgical recovery of zinc for leach residue is similar to that applied for the recovery of zinc from dust from an electric arc furnace (EAF) in the steel industry. The main difference is that the gas stream is different because the feed material is different. Leach residues contain sulphates which decompose in SO_2 gas. Therefore Waelz furnaces that process leach residues apply adapted gas cleaning.

At the Polish company ZGH Bolesław, approximately 90 % of the zinc is recovered in the neutral leaching stage. The remaining zinc is fixed in virtually insoluble zinc ferrites that account for 20–25 % of the total calcine mass. A typical composition of the leach residue is given in Table 6.35.

Table 6.35: Composition of residue from neutral leaching

Element	Concentration (%)	Element	Concentration (%)
Zn	14.5–20.0	SiO_2	1.8–2.5
Pb	7.5–11	S	6.5–9.0
Fe	20.0–30.0	S (as SO_4)	3.5–6.5
Cd	0.25–0.35	H_2O	18.0
As	0.2–0.3		
Mn	0.4–0.6		
Cu	0.15–0.25		

Source: [399, IZA 2012]

The zinc ferrites are treated in two Waelz kilns (40 metres in length and with an inner diameter of 2.6 m) operating with three zones. The charged material is composed of a mixture of ferrites with a maximum of 10 % sand and 40 % coke or anthracite.

Furnace gases carry the zinc-rich dust produced in the kiln through a dust chamber, then a mixing chamber and into a tubular cooler with forced airflow and finally a bag filter. The Waelz oxide product is collected at the outlet section of the cooler and bag filter. The dedusted gases are finally desulphurised in a wet scrubber, where limestone reacts with SO₂ and oxygen to produce gypsum.

Achieved environmental benefits

Elimination of the need for long-term storage of jarosite or goethite in lagoons.

Environmental performance and operational data

With a typical zinc recovery efficiency of 85–87 %, the Waelz oxide has a typical composition range as given in Table 6.36.

Table 6.36: Composition of Waelz oxide from the treatment of leaching residues

Element	Concentration (%)	Element	Concentration (%)
Zn	45–52	SiO ₂	0.3–1.0
Pb	15–21	S	1.5–4.5
Fe	2.0–5.0	F	0.10–0.12
Cd	0.6–1.2	Cl	0.5–1.5
As	0.15–0.25		
Mn	0.08–0.15		

Source: [399, IZA 2012]

The Waelz oxide is then returned to the neutral leach or directed to an ISF.

A typical composition range of the slag from the kiln is given in Table 6.37.

Table 6.37: Composition of Waelz slag from the treatment of leaching residues

Element	Concentration (%)	Element	Concentration (%)
Zn	2.6–3.5	Cd	0.004–0.006
Fe	25–35	As	0.01–0.1
Pb	0.8–2.0	SiO ₂	10–14

Source: [399, IZA 2012]

This slag can be used as inert fillers for backfilling operations, provided that this is in line with national requirements.

The emissions from the Waelz kiln process, after the bag filter and the scrubber, are:

- SO₂: 1 kg/t of product;
- NO_x: 2.5 kg/t of product;
- CO₂: 40 kg/t of product;
- PM₁₀: 0.3 kg/t of product;
- slag: 2.5 t/t of product;
- synthetic gypsum from the FGD plant: 200 kg/t of product;

- effluents (slag cooling): 0.007 m³ per tonne of product, treated in the on-site waste water treatment plant.

Emissions in concentrations are given in Table 6.38.

Table 6.38: Emissions from the Waelz kiln process

Year	Pb	Cd	Dust	SO ₂	NO _x	PCDD/F
	mg/Nm ³	mg/Nm ³	mg/Nm ³	mg/Nm ³	mg/Nm ³	ng I-TEQ/Nm ³
2011	0.180	0.009	3.5	415.27	19.27	0.200
<i>Source: [400, IZA 2013]</i>						

A Waelz kiln installation treating hydrometallurgical slimes consumes [229, IZA plant data 2008]

- reducing agent (coke, anthracite): 1.25 t/t of product;
- SiO₂: 0.2 t/t of product;
- natural gas: 85 Nm³/t of product;
- electric energy: 270 kWh/t of product;
- compressed air: 600 Nm³/t of product.

Cross-media effects

- Increase in energy use.
- Direct CO₂ emissions.
- Potentially more dust emissions that need appropriate collection.
- Sulphates/sulphides sludge from the SO₂ scrubber system.
- Elements that are poorly/not fumed in the Waelz operation, such as Cu, Ni, Co and Ag, and/or that are poorly/not exploited (lost in the slag) can have a negative effect on the leachability characteristics of the slag.

Technical considerations relevant to applicability

This technique is applicable to neutral leaching residues from hydrometallurgical zinc production that do not contain excessive quantities of zinc ferrites (< 10 % of the total zinc remains unleached in zinc ferrites after neutral leaching) and/or that do not contain high concentrations of precious metals.

Economics

The economics are difficult to predict but, if more than 10 % of the total zinc required pyrometallurgical treatment (fuming) before being reinjected into the hydrometallurgical route and sent for electrolysis, the process would be energy-intensive and not economically viable.

Driving force for implementation

- Elimination of hazardous waste (jarosite) to be stored.
- Increased zinc recovery yield.

Example plants

Plant O, Plant G, and Korea Zinc.

Reference literature

[229, IZA plant data 2008], [305, Ausmelt 2009].

6.3.1.2.8.2 Inertisation and compaction techniques to improve the disposal of leaching residues from hydrometallurgical zinc production

6.3.1.2.8.2.1 Jarofix process

Description

The Jarofix process consists of mixing jarosite precipitates formed during the leaching of zinc ferrites with preset ratios of Portland cement, lime and water.

Technical description

The reaction of jarosite precipitates $[\text{NH}_4\text{Fe}_3(\text{SO}_4)_2(\text{OH})_6]$ and Portland cement, lime and water generates a chemically and physically stable material, reducing the long-term liability associated with iron residue disposal while offering the concomitant processing advantages. Supporting mineralogical studies of aged Jarofix products indicate that jarosite reacts with the alkaline constituents of the cement to form various stable phases that incorporate zinc and other soluble metals. The persistence of alkaline phases in the Jarofix product helps to ensure its long-term environmental stability [229, IZA plant data 2008], [289, USEPA 2008].

The process has not yet been proven to be equally effective on goethite.

Achieved environmental benefits

- Stabilisation of jarosite as a waste that can be disposed of in non-hazardous waste landfills, therefore eliminating the need for its storage in lagoons.
- Less surface needed in the case of landfilling the waste since, in contrast to lagoons, no dam is needed to contain the deposit.
- Potential use for land reclamation.

An example of the use of the Jarofix process to reclaim land is the restoration of a quarry that 'ate into' a mountain to extract gravel. The first photo in Figure 6.25 shows the area in August 1999 (before landfilling) and the second picture shows the area in December 2014. The intention is to restore, as far as possible, the original profile of the mountain.



August 1999: before landfiling



December 2014: landscape restoration ongoing with Jarofix
 Source: [424, Asturiana de Zinc 2014]

Figure 6.25: Landscape restoration with Jarofix

Environmental performance and operational data

For quality control purposes, the Jarofix is leached using an acidic or buffered solution. The resulting extract is analysed and compared to a leachate criteria list. If the resulting concentration is equal to or in excess of the concentration specified for that pollutant according to national specifications, the material is considered toxic leachate and may not be suitable for recovery. The results obtained, however, show that the Jarofix produced has a very low leachable metal content.

Council Decision 2003/33/EC established the criteria for the acceptance of waste at landfills. The criteria are based on the leachability in water of a given waste at the stage of being received at a landfill installation. Table 6.39 shows typical results for Jarofix waste tested according to these criteria from plants applying this technique in Europe (Plants C and F).

Table 6.39: Criteria for the acceptance of waste at landfills for non-hazardous wastes and typical results for Jarofix waste tested according to Council Decision 2003/33/CE

Parameter	Leachate limit value liquid/solid = 10 litres/kg	
	Criteria for waste acceptable at landfills for non-hazardous waste (mg/kg dry matter)	Tested Jarofix (mg/kg dry matter)
Antimony	0.7	< 0.05
Arsenic	2	0.059
Barium	100	1.72
Cadmium	1	< 0.01
Chromium (total)	10	0.414
Copper	50	< 0.05
Mercury	0.2	< 0.0010
Lead	10	6.40
Molybdenum	10	2.41
Nickel	10	< 0.05
Selenium	0.5	< 0.05
Zinc	50	0.613
Chloride	15 000	89.0
Fluoride	150	11.0
Sulphate	20 000	13370
DOC	800	12
TDS	60 000	27 760
TVOC	*	2200
ANC (mg CaCO ₃ /l)	*	282
pH	*	> 10

* Hazardous waste acceptable at landfills for non-hazardous waste, the maximum TVOC value is 50 000, the ANC must be evaluated and the pH should be ≥ 6.
NB: DOC = Dissolved organic carbon.

Cross-media effects

Consumption of Portland cement as reagent, which involves an increase in the weight of the residue generated (approximately 1.15 tonnes of Jarofix per tonne of jarosite produced).

Technical considerations relevant to applicability

This technique is applicable to jarosite iron residues from zinc production.

Economics

No data have been reported but a confidential review of the processes available to stabilise the jarosite residue concluded that the Jarofix process was the most economical way to comply with local environmental legislation.

Driving force for implementation

- Reduced availability of deposits for leachable iron residues.
- Environmental regulation requirements.

Example plants

Plant C and Plant F.

Reference literature

[229, IZA plant data 2008], [264, Seyer, Chen 1999]

6.3.1.2.8.2.2 *Sulphidation process***Description**

The sulphidation process consists of the addition of NaOH and Na₂S to the jarosite precipitates in order to obtain a stabilised form.

Technical description

In the sulphidation process, jarosite precipitates formed during the leaching of zinc ferrites are treated by sulphidation to achieve a stable form of the residue that fulfils leachability criteria regarding the disposal of waste to hazardous waste landfill. Sulphidation is an appropriate technique regarding jarosite treatment, but it is also suited to the treatment of sulphur residue from direct leaching, separately or together with jarosite.

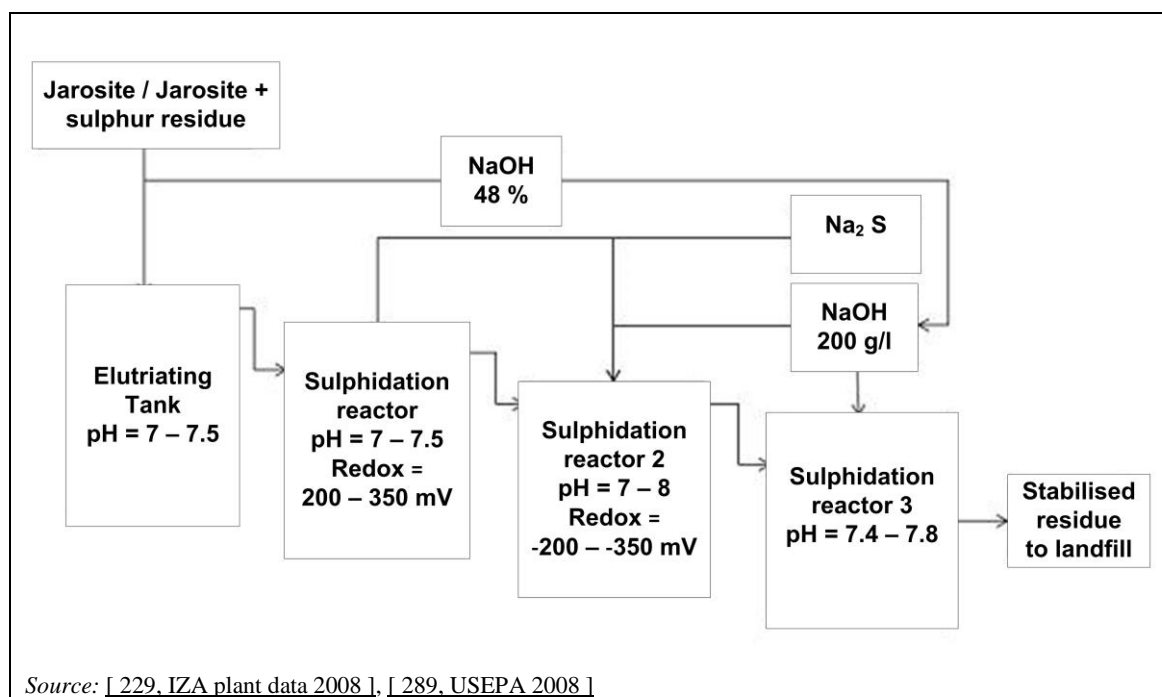

Figure 6.26: Flowsheet of the sulphidation process

Sludges produced during the process that are destined for on-site disposal should be pretreated to reach the standards in Council Decision 2003/33/EC, e.g. washed free of zinc or other metals and dewatered as far as possible. Disposal facilities should be totally contained and leakproof. They are subject to local control and regulation. Water from the sludge containment areas can be returned to the zinc production process.

The reaction generates a chemically stable material, reducing the long-term solubility associated with iron residue disposal.

Stabilised residue is pumped in the form of wet sludge to landfill.

Achieved environmental benefits

- Stabilisation of jarosite as a hazardous waste that can then be disposed of in hazardous waste landfills.
- Less landfill surface needed than in the Jarofix process. Although the stabilised waste is pumped in the form of wet sludge to landfill, transfer water is circulated back to the zinc production process, therefore no increase in volume takes place.
- Natural resource savings, since sulphidated jarosite has geotechnical properties that permit the material to be used in the building of embankments and other constructions at the landfill site.

Environmental performance and operational data

Council Decision 2003/33/EC established the criteria for the acceptance of waste at landfills. The criteria are based on the leachability in water of a given waste at the stage of being received at a landfill installation. Table 6.40 shows typical results for sulphidated common waste (jarosite and sulphur residue) from plants applying this technique in Europe (Plants A and D). The dissolution test and analysis are carried out according to EN 12457-3 and other appropriate standards mentioned in landfill legislation.

Table 6.40: Criteria for the acceptance of waste at landfills for hazardous wastes and typical results for sulphidated waste (jarosite and sulphur residue)

Parameter	Criteria for waste acceptable at landfills for hazardous waste	Sulphidated jarosite + sulphur residue
	L/S 10 (mg/kg dry matter)	L/S 10 (mg/kg dry matter)
Antimony	5	0.83
Arsenic	25	0.02
Barium	300	0.3
Cadmium	5	0.29
Chromium (total)	70	< 0.03
Copper	100	0.08
Mercury	2	0.001
Lead	50	6.5
Molybdenum	30	0.08
Nickel	40	0.97
Selenium	7	< 0.12
Zinc	200	21
Chloride	25 000	43
Fluoride	500	< 16
Sulphate	50 000	21 000
DOC	1000	19
TDS	100 000	
TVOC	6 %	< 0.2 %
ANC (mg CaCO ₃ /litre)	Must be evaluated	
NB: DOC = Dissolved organic carbon. L/S = liquid/solid		

Cross-media effects

Water recycling system necessary.

Technical considerations relevant to applicability

This technique is applicable to jarosite iron residues from zinc production.

Economics

No information provided.

Driving force for implementation

- Reduced availability of deposits for leachable iron residues.
- Environmental regulation requirements.

Example plants

Plant A and Plant D.

Reference literature

[229, IZA plant data 2008], [264, Seyer, Chen 1999], [289, USEPA 2008]

6.3.1.2.8.2.3 *Compacting iron residues*

Description

Compacting iron residues consists of reducing their moisture content by means of a high-pressure press filter and the addition of lime or other agents. The filter cake obtained is disposed of in a basin and each layer of the cake is further compacted with specific heavy vehicles.

Technical description

Compacting is a technique to increase the capacity of an iron residue storage area. The classical way to store goethite and jarosite is by pumping the slurry into a pond (with a plastic liner covering the bottom and walls) for settling, and then pumping the cleared solution at the surface back to the plant for zinc recovery, while the settled solid material remains at the bottom of the pond. The pond is gradually filled with cake until it is completely full. At the end of its life, the pond is covered. This type of traditional storage is referred to as hydraulic storage.

The compacting technique involves filtering the goethite by means of a high-pressure press filter (15–30 bars) combined with the addition of lime or other agents to decrease the inherent leachability of metals. The filter cake is transported into a basin, similar to the type used for classical storage (or an existing emptied pond), and each layer of the cake is then further compacted by means of a specific heavy vehicle. The final moisture content of the stored iron-rich residue is significantly lower than in a classical pond (reduced from about 60–65 % to 35 %; e.g. Nyrstar plant in Balen, Belgium) and, due to the firm nature of the cake, it can be formed into a mound and so the storage capacity is increased by a factor two to four depending on the final height. The storage is gradually covered to minimise the amount of rainwater to be treated in the waste water treatment plant or in the zinc process.

This technique has not yet been tried for jarosite residues.

Achieved environmental benefits

- Less landfill volume needed, due to the production of a denser iron residue.
- Reduced risk of accidental leakage because the permeability of the stored material is extremely low and is in the same order as clay. The leachability of metals can be decreased by adding lime or other additives.
- No aqueous solution on top of the solid material.
- Less zinc losses associated with the discarded iron residue, because the residual moisture content is much lower (-65 %).

Environmental performance and operational data

- Specific permeability (K-value) can be decreased to approximately $< 10^{-9}$ m/s.

- Reported typical leachability levels for goethite plus 5 % CaO and gypsum-rich waste water treatment sludge are given in Table 6.41.

Council Decision 2003/33/EC established the criteria for the acceptance of waste at landfills. The criteria are based on the leachability in water of a given waste at the stage of being received at a landfill installation. Table 6.41 shows typical results for compacting goethite and waste water treatment plant sludges from plants applying this technique in Europe (Plants E and P).

Table 6.41: Leaching test criteria and obtained results for compacted iron residues

Parameter	Leaching test criteria: NEN 12457-2- S4; L/S = 10 l/kg; pH 7; 24-hour	
	Typical values: Tested Goethite + 5 % CaO (mg/kg dry matter)	Typical values: Tested WWTP sludge (mg/kg dry matter)
Antimony	0.21	0.24
Arsenic	< 0.04	< 0.04
Barium	0.38	0.34
Cadmium	2.40	0.48
Chromium (total)	0.02	0.02
Chromium(VI)	< 0.20	< 0.20
Copper	0.055	0.11
Mercury	0.0026	0.079
Lead	0.19	0.9
Molybdenum	0.25	0.31
Nickel	< 0.04	< 0.04
Selenium	0.12	0.38
Zinc	11	2.2
Chloride	257	384
Fluoride	91.5	80.2
Sulphate	17 600	16 000
DOC	14	34
TDS	24 000	24 000
TVOC	< 1.2 %	< 1.2 %
pH (KCl)	7.67	8.13

NB: DOC = Dissolved organic carbon.

Cross-media effects

- No stabilisation of the waste takes place.
- Increased energy consumption to compact the iron residue.
- Consumption of lime (0–5 %).

Technical considerations relevant to applicability

This technique is applicable to goethite residues from zinc production, as well as to gypsum-rich WWTP sludge.

Economics

It is reported that the costs are comparable to hydraulic storage (for non-compacted deposition in a pond). There is a shift from capital costs (less pond area required) to operating costs (press filter plus handling plus *in situ* compaction).

The operating expenditure (manpower, maintenance, energy, additives, etc.) is about EUR 20–25/t.

The capital expenditure (building, filter, pumps, vessels, local infrastructure, but excluding the cost of the land and the construction of the pond) is about EUR 11 million for a capacity of 100 kt/yr. [399, IZA 2012]

Driving force for implementation

- Optimal use of available land.
- Increased lifetime of existing ponds.

Example plants

Plant E and Plant P.

Reference literature

[274, COM 2008], [399, IZA 2012] based on 'How to substantially improve the life of a 30 Ha tailings pond at Umicore Zinc Plant', S. Foged and J. Vandekeybus, Environmental Services MWH, Mechelen

6.3.1.2.9 Techniques to recover heat from hydrometallurgical zinc production

Description

The techniques to consider are:

- waste heat boiler;
- turbine.

Technical description

Furnace gases pass from the roaster offtake, near the furnace top, to the immediately adjacent waste heat boiler, designed for a horizontal gas flow, where a large proportion of entrained calcine dust is removed and the gases are cooled from about 1000 °C to 350 °C or lower. The dew point of the wet off-gas containing SO₂ sets a strict lower limit on the operation of the boiler, as condensation of corrosive vapours must be avoided in this part of the process.

The boiler is a forced circulation unit (e.g. La Mont), consisting essentially of several evaporators and one superheater tube bundle in the gas stream and an external steam drum.

Hot water is continuously circulating between the steam drum and evaporator bundle, as well as the furnace bed cooling coils, while steam flashed off the steam drum passes through the superheater bundle before going to steam consumer units. The calcine cooling system can be used as an additional heat recovery system connected to the waste heat boiler.

Using turbines, energy from the 290–400 °C and 4 MPa superheated steam is recovered either as electrical power or directly as mechanical energy (for example, to drive the fluidised bed blower fan or various extraction fans in the gas-cleaning and sulphuric acid plants). The heat from the low-pressure steam exiting the turbines is then used for zinc plant process requirements and office heating. Some plants use the low-pressure steam to drive a turbine alternator to generate electricity as well. The choice depends on the local energy market conditions.

Ancillary equipment associated with the boiler includes high-duty electric feed water and circulating water pumps, supported by steam turbine standby units. A highly sophisticated

instrument control system permits almost complete control of the boiler operations. In addition, the need for extremely pure boiler feed water necessitates the operation of a demineralising plant and boiler chemical reagent injection systems.

Calcine from both the roasting furnace and the waste heat boiler is cooled in a rotary cooler, either of a rotary variety or a fluidised bed cooler. For this purpose, water passes through the cooler without contacting the calcine and a heat exchange is carried out. After calcine cooling, the resulting warm water can be used in other steps of the hydrometallurgical process (e.g. replenishing process water losses due to evaporation, cleaning operations). Usually, this water reuse requires a previous cooling step that can be achieved by either air-liquid contact (cooling towers) or additional cooling by means of heat exchange, e.g. with seawater. In these cases, which are the most frequent, no heat recovery takes place.

The cooling water from the mill is of a lower quality than the water for the high-pressure steam turbine. This cooling water is most often recycled to the process, e.g. for washing filter cakes.

Further heat source will come from the sulphuric acid plant in the form of an economiser to preheat the feed water entering the waste heat boiler system.

Achieved environmental benefits

Recovery of exothermic reaction heat and conversion into electricity and low-pressure steam for process and office heating.

Environmental performance and operational data

Typical energy recovery rate for a RLE plant: 3.5 MJ/t Zn.

Cross-media effects

None reported.

Technical considerations relevant to applicability

Generally applicable to RLE plants.

Economics

As cooling of the gas is required anyway, the additional cost for recovery of the energy mainly relates to the investment in the turbine for electricity generation.

Driving force for implementation

Energy recovery.

Example plants

All RLE plants in Europe.

Reference literature

No reference literature provided.

6.3.1.3 Pyrometallurgical zinc production

6.3.1.3.1 Techniques to reduce emissions to air in pyrometallurgical zinc production

Description

The techniques to consider are:

- Venturi scrubber (see Section 2.12.5.1.6);
- bag filter (see Section 2.12.5.1.4).

Technical description

Venturi scrubber (see Section 2.12.5.1.6)

In the only EU plant producing zinc via the pyrometallurgical route, Venturi scrubbers are applied in the following stages of the process:

- coke area;
- charge preparation unit of the sintering plant;
- sinter crushing;
- charge preparation unit of the ISF;
- spray condenser;
- slag granulation.

Bag filter (see Section 2.12.5.1.4)

In the only EU plant producing zinc via the pyrometallurgical route, bag filters are applied in the following stages of the process:

- sinter plant;
- sinter crushing area;
- ISF;
- New Jersey process.

Achieved environmental benefits

Reduction of dust and volatile metals (Zn, Pb or Cd) emissions.

Environmental performance and operational data

Venturi scrubber

Plant-specific data from Plant O are given in Table 6.42.

Table 6.42: Emissions after abatement with Venturi scrubbers in pyrometallurgical zinc production

Pollutant	Applied technique	Unit	Values obtained under normal operating conditions			Information regarding data collection
			Minimum	Average	Maximum	Method
Emission source: coke area						
Dust	Wet scrubber	mg/Nm ³	8.2	10.7	13.2	PN-Z-04030-7:1994
Emission source: charge preparation unit of sinter plant						
Dust	Wet scrubber	mg/Nm ³	5.7	8.3	10.9	A-METAXDG1
Zn		mg/Nm ³	1.13	1.68	2.23	
Pb		mg/Nm ³	0.52	0.65	0.77	
Cd		mg/Nm ³	0.006	0.032	0.058	
Emission source: charge preparation unit of sinter plant						
Dust	Wet scrubber	mg/Nm ³	4.2	7.1	10	A-METAXDG1
Zn		mg/Nm ³	0.85	1.04	1.23	
Pb		mg/Nm ³	0.39	0.59	0.79	
Cd		mg/Nm ³	0.004	0.035	0.066	
Emission source: sinter crushing area (measurement after the scrubber and released by chimney)						
Dust	Wet scrubber	mg/Nm ³	3.1	6.7	10.3	A-METAXDG1
Zn		mg/Nm ³	1.5	2.5	3.5	
Pb		mg/Nm ³	0.75	0.89	1.02	
Cd		mg/Nm ³	0.015	0.018	0.021	
Emission source: charge preparation unit of ISF						
Dust	Wet scrubber	mg/Nm ³	6.6	9.6	12.5	A-METAXDG1
Zn		mg/Nm ³	2	2.9	3.8	
Pb		mg/Nm ³	0.32	0.76	1.2	
Cd		mg/Nm ³	0.009	0.013	0.016	
Emission source: slag granulation						
Dust	Wet scrubber	mg/Nm ³	9.8	12.5	15.2	A-METAXDG1
Zn		mg/Nm ³	0.2	0.8	1.3	
Pb		mg/Nm ³	0.09	0.13	0.17	
Cd		mg/Nm ³	0.006	0.008	0.01	
NB: Method to obtain data: Discontinuous measurement, spot sampling. Type of average: Average over the sampling period. Number of campaigns & samples: 2. Source: [378, Industrial NGOs 2012]						

Bag filter

Plant-specific data from Plant O are given in Table 6.43.

Table 6.43: Emissions after abatement with bag filters in pyrometallurgical zinc production

Pollutant	Applied technique	Unit	Values obtained under normal operating conditions			Information regarding data collection
			Minimum	Average	Maximum	Method
Emission source: sinter plant						
Dust	Bag filter	mg/Nm ³	0.33	1.12	1.9	PN-Z-04030-7:1994
Zn		mg/Nm ³	0.17	0.18	0.19	A-METAXDG1
Pb		mg/Nm ³	0.01	0.05	0.08	
Cd		mg/Nm ³	0.002	0.005	0.007	
SO ₂		mg/Nm ³	690	710	730	PN-ISO 10396:2001
CO		mg/Nm ³	15	16	17	
Emission source: sinter plant						
Dust	Bag filter	mg/Nm ³	0.63	0.78	0.92	PN-Z-04030-7:1994
Zn		mg/Nm ³	0.34	0.39	0.43	A-METAXDG1
Pb		mg/Nm ³	0.05	0.1	0.14	
Cd		mg/Nm ³	0.002	0.0026	0.0031	
SO ₂		mg/Nm ³	1030	1055	1080	PN-ISO 10396:2001
CO		mg/Nm ³	51	52	53	
NO ₂		mg/Nm ³	220	230	240	
Emission source: sinter crushing area						
Dust	Bag filter	mg/Nm ³	0.52	1.11	1.7	PN-Z-04030-7:1994
Zn		mg/Nm ³	0.12	0.36	0.59	A-METAXDG1
Pb		mg/Nm ³	0.22	0.27	0.31	
Cd		mg/Nm ³	0.0017	0.0024	0.003	
Emission source: ISF						
Dust	Bag filter	mg/Nm ³	0.7	1.3	1.8	PN-Z-04030-7:1994
Zn		mg/Nm ³	0.2	0.45	0.69	A-METAXDG1
Pb		mg/Nm ³	0.25	0.29	0.33	
Cd		mg/Nm ³	0.019	0.03	0.041	
SO ₂		mg/Nm ³	6	10	14	
Emission source: NJ process						
Dust	Bag filter	mg/Nm ³	4.4	4.9	5.4	PN-Z-04030-7:1994
Zn		mg/Nm ³	2.37	2.94	3.5	A-METAXDG1
Pb		mg/Nm ³	0.006	0.046	0.085	
Cd		mg/Nm ³	0.006	0.009	0.012	
SO ₂		mg/Nm ³	< LOD	< LOD	< LOD	PN-ISO 10396:2001
CO		mg/Nm ³	< LOD	< LOD	< LOD	
NO ₂		mg/Nm ³	12	13	14	
NB: Method to obtain data: Discontinuous monitoring, spot sampling. Type of average: Average over the sampling period. Number of campaigns & samples: 2. Source: [378, Industrial NGOs 2012]						

Cross-media effects

Increase in energy use.

Technical considerations relevant to applicability

No information provided.

Economics

No information provided.

Driving force for implementation

No information provided.

Example plants

Plant O.

Reference literature

No reference literature provided.

6.3.1.3.2 Techniques to reduce SO₂ and dioxins emissions in pyrometallurgical zinc production

Description

The technique to consider to reduce SO₂ emissions (low-SO₂ off-gases) is the use of a semi-dry scrubber.

Technical description

See Section 2.12.5.2.3.

Achieved environmental benefits

No information provided.

Environmental performance and operational data

Table 6.44 shows the SO₂ emissions achieved after abatement with a semi-dry scrubber in pyrometallurgical zinc production.

Table 6.44: Emissions after abatement with a semi-dry scrubber of a low-SO₂ off-gas in pyrometallurgical zinc production

Pollutant	Applied technique	Unit	Values obtained under normal operating conditions				Information regarding data collection	
			Average	Maximum	Type of average	Method to obtain data	Method	Reference oxygen content (%)
Emission source: sinter plant (measurement after the bag filter and released by chimney)								
SO ₂	Semi-dry scrubber (with lime injection)	mg/Nm ³	560	680	Daily	Continuous monitoring	IR	6
Source: [400, IZA 2013]								

Plant O has no specific abatement equipment for dioxins. Emissions reported at the sintering plant are 0.02 ng I-TEQ/Nm³. No abatement equipment is available for mercury, but the feed material is checked for mercury.

Cross-media effects

No information provided.

Technical considerations relevant to applicability

No information provided.

Economics

No information provided.

Driving force for implementation

No information provided.

Example plants

No information provided.

Reference literature

No reference literature provided.

6.3.2 Primary and secondary zinc production applying recycling routes

6.3.2.1 Recycling of metallic streams

General techniques applied to reduce diffuse emissions from the reception, storage and handling of primary and secondary raw materials are considered in Chapter 2 (see Section 2.12.4.1) and in the Emissions from Storage BREF [[290, COM 2006](#)].

6.3.2.1.1 Techniques to reduce emissions from melting metallic and mixed metallic/oxidic streams

Description

The techniques to consider are:

- bag filter (see Section 2.12.5.1.4);
- activated carbon filter (see Section 2.12.5.3) or afterburner (see Section 2.12.5.2.1).

Technical description

Bag filter

The off-gas of the furnace is first filtered by a bag filter to avoid dust.

Activated carbon filter or afterburner

If zinc scrap containing organic impurities is used (paint, tar, etc.), an activated carbon filter or post-combustion can be necessary in addition to the bag filter to remove the TVOC in the off-gas. Typically, activated carbon is used when organic quantities are low. Post-combustion is used when quantities are high.

Achieved environmental benefits

Reduction of dust, dioxins and VOC emissions.

Environmental performance and operational data*Bag filter*

Filtration with fabric filters to capture dust typically achieves levels of $< 5 \text{ mg/m}^3$, and often $< 1 \text{ mg/m}^3$.

Activated carbon filter or afterburner

The reported performance of an activated carbon filter in Plant N is shown in Table 6.45.

Table 6.45: Emissions from an activated carbon filter in Plant N

Component	mg/Nm ³
Benzene	< 5
TVOC	< 50
Dioxins	< 0.4 ng I-TEQ/m ³
<i>Source: [378, Industrial NGOs 2012]</i>	

Cross-media effects

- Increase in energy use.
- Use of activated carbon.

Technical considerations relevant to applicability

No information provided.

Economics

No information provided.

Driving force for implementation

- Reduction of dust emissions to provide a healthy environment for operators.
- Environmental regulatory requirements.

Example plants

Plants in Belgium and Germany.

Reference literature

No reference literature provided.

6.3.2.2 Recycling of oxidic raw materials**6.3.2.2.1 Techniques to prevent and reduce emissions from fuming furnaces****6.3.2.2.1.1 Techniques to prevent and reduce emissions from the plasma arc fuming process****Description**

The techniques to consider are:

- bag filter (see Section 2.12.5.1.4);
- mercury filter (see Section 2.12.5.5);
- wet scrubber (see Section 2.12.5.2.2).

Technical description

Figure 2.27 shows a flowsheet of the plasma arc fuming process.

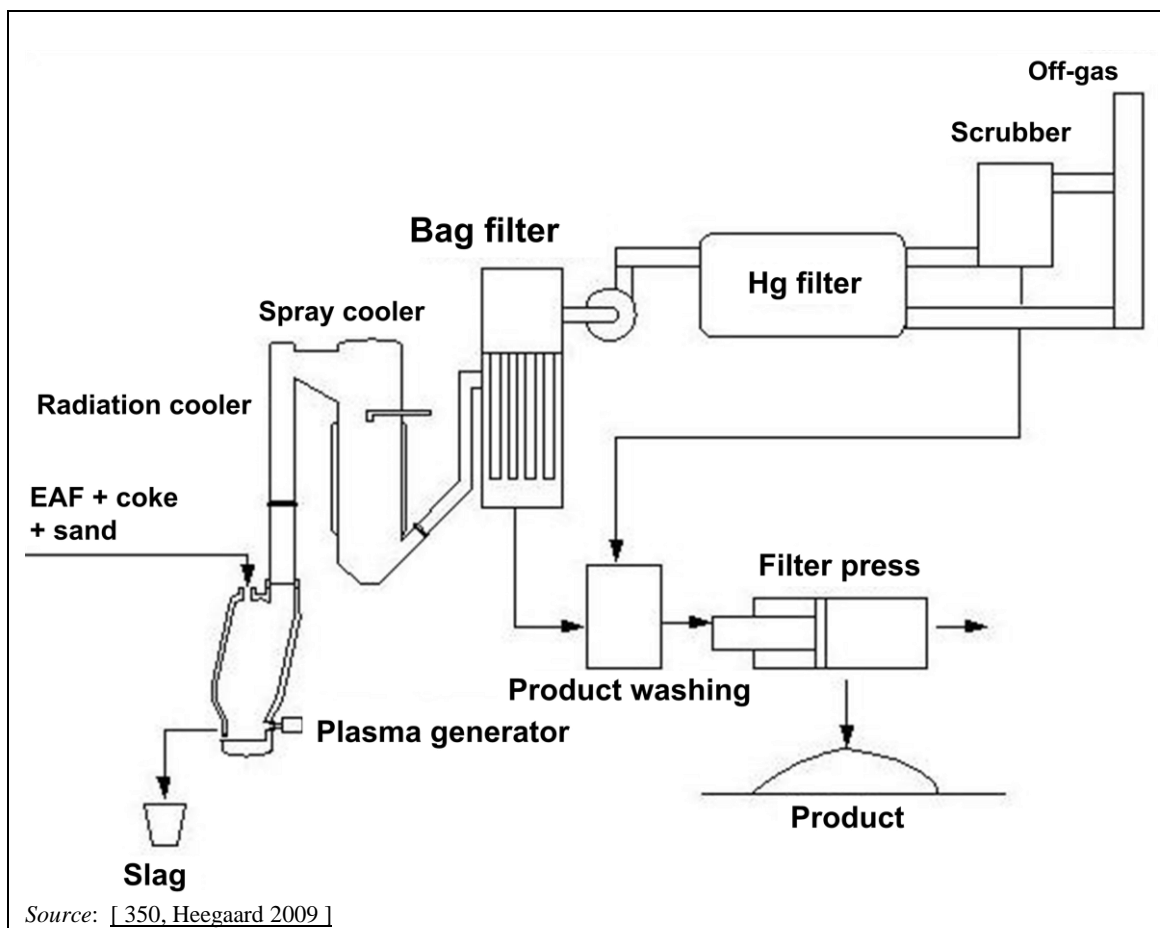

Figure 6.27: Flowsheet of the plasma arc fuming process

The off-gases produced by the process have to be cooled and cleaned. Elements such as fluorine and chlorine are stripped by injecting NaOH into the spray cooler and scrubber. Mercury is removed in an activated carbon filter. Reoxidised zinc and lead are removed from the off-gases in the bag filters, from where they are then collected for washing. Water with additions of Na_2CO_3 is used for product washing to reduce the amount of chlorine and fluorine in the final product. Metals such as cadmium, lead and zinc are present in the washing water and the pH in the washing tanks is adjusted in the range between 9.5 and 11 to minimise the concentration of these metals. The washing water is monitored and is treated before discharge to the environment by the addition of Na_2S .

Achieved environmental benefits

Reduction of dust, mercury and acid gas emissions.

Environmental performance and operational data

Cleaned off-gases consist mainly of CO_2 , H_2O and N_2 . Table 6.46 shows the main gaseous components of the off-gases. No data were provided for emissions of dust, HCl, HF or Hg.

Table 6.46: Main gaseous components of the plasma arc fuming process

Component	(%)	(kg)
CO ₂	4.0	300
H ₂ O	29.4	2207
N ₂	56.4	4233
O ₂	10.1	758
Other	0.1	8
<i>Source:</i> [350, Heegaard 2009]		

The fluorine and chlorine content is below 0.2 %.

Cross-media effects

- Increase in energy use.
- Increase in reducing agents consumption.

Technical considerations relevant to applicability

Generally applicable.

Economics

No information provided.

Driving force for implementation

Reduction of emissions to air.

Example plants

Høyanger (NO), Hofors (SE), and Calais (FR).

Reference literature

[350, Heegaard 2009]

6.3.2.2.1.2 Techniques to prevent and reduce emissions from a fuming furnace in a process for production of secondary ZnO from a copper smelter

Description

The techniques to consider are:

- ESP (see Section 2.12.5.1.1);
- activated carbon injection (see Section 2.12.5.3);
- bag filter (see Section 2.12.5.1.4);
- wet scrubber (see Section 2.12.5.2.2).

Technical description

Figure 6.28 shows the flowsheet of a fuming furnace integrated with a clinker furnace in a copper smelter process.

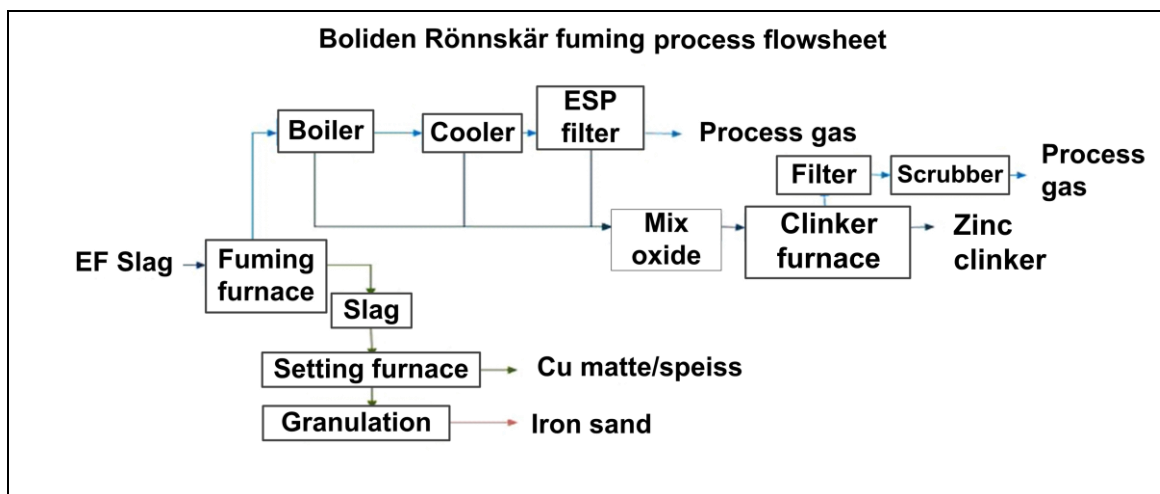

Figure 6.28: Fuming furnace integrated with a clinker furnace in a copper smelter process

The gas from the fuming furnace passes through three steps before being emitted to air: a waste heat boiler to recover heat for electricity generation and district heating, a cooling tower, and finally an ESP.

Activated carbon is injected into the off-gas from the clinker furnace to reduce dioxin emissions, and this is followed by a bag filter and a scrubber (SO₂ emissions can be reduced by adding alkaline to the scrubber water).

Achieved environmental benefits

Reduction of dust, dioxins and acid gas emissions.

Environmental performance and operational data

Cleaned off-gases consist mainly of CO₂, H₂O and N₂. Table 6.47 shows the main gaseous components of the off-gases. No data were provided for emissions of dust, HCl, HF or Hg.

Table 6.47: Main gaseous components of the zinc fuming process

Component	(%)
CO ₂	5.5–7
H ₂ O	20–25
N ₂	45–70
O ₂	5–10
SO ₂	300 ppm

The fluorine and chlorine content is below 0.005 %.

Cross-media effects

- Increase in energy use.
- Use of coal as a reducing agent results in emissions of CO₂.

Technical considerations relevant to applicability

Generally applicable. Regarding the fuming technology, it is well known and commonly applied for pyrometallurgical melts containing volatile substances.

Economics

No information provided.

Driving force for implementation

Reduction of emissions to air.

Example plant

Boliden Rönnskär (SE).

Reference literature

No reference literature provided.

6.3.2.2.2 Techniques to prevent and reduce emissions from multiple hearth furnaces

There are no longer any multiple hearth furnaces operating in Europe.

In principle, this technique is very similar to the one described in Section 6.3.2.2.1.1, so the same abatement techniques could be considered.

6.3.2.2.3 Techniques to prevent and reduce emissions from the rotary Waelz kiln process**6.3.2.2.3.1 Techniques to prevent and reduce emissions from secondary materials during pelletising****Description**

The technique to consider is the use of a bag filter (see Section 2.12.5.1.4).

Technical description

The different feed materials for the Waelz kiln are stored in storage halls or in silos. The material is transported by conveyors to the mixing devices, where it is pelletised and sent to the Waelz kiln via conveyors. In order to minimise dust emissions, the conveyors, screws and mixing devices can be completely enclosed so that no dust can escape. The dust emitted by mixing devices and conveyors that are not enclosed is expelled and treated in the bag filter in the existing off-gas system. In conveying systems that cannot be fully enclosed, dust is prevented by wetting the material.

Achieved environmental benefits

- Good workplace health conditions.
- Very low fugitive emissions.
- Higher process efficiency with pellets.

Environmental performance and operational data

Bag filters have a typical outlet dust level of $< 5 \text{ mg/Nm}^3$.

Cross-media effects

None reported.

Technical considerations relevant to applicability

Applicable to all powdery feed material for the Waelz kiln.

Economics

No information provided.

Driving force for implementation

- Environmental regulatory requirements.
- Improved workspace air quality.

- Improved process efficiency.

Example plants

Plants in ES, IT, FR and DE.

Reference literature

No reference literature provided.

6.3.2.2.3.2 Techniques to prevent and reduce emissions from melting in rotary Waelz kilns

Description

The techniques to consider are:

- dust chamber;
- bag filter (see Section 2.12.5.1.4) or ESP (see Section 2.12.5.1.1);
- adsorbent addition (see Section 2.12.5.3);
- RTO (see Section 2.12.5.2.1).

Technical description

The gas flow and the feed material are positioned countercurrently in the furnace so that the zinc-containing off-gas leaves the Waelz kiln where the feed is charged. A first separation of coarser dust particles takes place in a dust chamber where the gas speed is reduced and dust particles can precipitate. Here, a first cooling of the off-gas can be conducted by injecting air or water into the off-gas stream. In the second step, the off-gas is cooled down to a temperature adequate for entering the ESP (optionally) and the bag filter. This can be achieved by a heat exchanger or by injecting air and/or water. The ESP and the subsequent bag filter remove the remaining dust particles from the off-gas stream. After passing the ESP and bag filter and depending on the mercury content of the raw material, an adsorbent (lignite coke mixed with limestone/lime hydrate) can be injected into the off-gas in order to remove mercury and organics. This material is precipitated in a second bag filter (filsorption). Depending on the plant configuration and local conditions, organic compounds in the off-gas can be removed by a subsequent post-combustion step.

The SO₂ emissions depend to a great extent on the type of sulphur compounds in the feed material. Sulphur compounds in residues from neutral leaching (ZnSO₄) are volatile and leave the Waelz kiln with the off-gas, whereas sulphur originating from coke leaves the furnace with the slag. Therefore, a special step for removal of SO₂ from the off-gas is only necessary if volatile sulphur compounds exist in the feed material.

Achieved environmental benefits

Reduction of dust, metals, dioxins and VOC emissions.

Environmental performance and operational data

Plant-specific data for emissions in 2011 from a Waelz plant treating EAF dust are given in Table 6.48. Plants J, K, L and M are operating the SDHL process. The gas flow in Plant L is much higher than in the other plants. This is related to the fact that gas cooling is done by blowing fresh air into the gas stream.

Table 6.48: Plant-specific data for stack emissions to air from Waelz furnaces

Plant		I		J		K		L		M	
Flow (average)	Nm ³ /h	64 000		66 500		88 100		166 146		73 110	
		Avg.	Max.	Avg.	Max.	Avg.	Max.	Avg.	Max.	Avg.	Max.
Dust	mg/Nm ³	0.35	1.54	0.5	1.1	< 0.3	< 0.3	0.832	2.2	2.54	5.6
Zn	mg/Nm ³	NA		NA		NA		0.138	0.692	NA	
Cd	mg/Nm ³	0.002	0.005	0.003	0.005	0.008	NA	0.001	0.004	0.002	0.004
Pb	mg/Nm ³	NA		0.009	0.01	0.008	NA	0.017	0.087	0.091	0.383
Hg	mg/Nm ³	0.009	0.01	0.05	0.1	0.002	0.003	0.004	0.019	0.091	0.164
As	mg/Nm ³	NA		NA		NA		0.002	0.008	< 0.000 2	< 0.0002
Cu	mg/Nm ³	NA		NA		NA		NA		0.024	0.096
Cr	mg/Nm ³	NA		NA		NA		NA		0.008	0.027
Ni	mg/Nm ³	NA		NA		NA		NA		0.012	0.042
Pb+Mn +Cu+Cr +V+Sn	mg/Nm ³	0.039	0.047	NA		NA		0.08		0.224	NA
SO ₂	mg/Nm ³	7.6	NA	5.70	9.8	28.69	76.2	39.05	96	0.01	0.04
HCl	mg/Nm ³	3.23	NA	0.30	0.6	0.38	0.64	0.11	0.2	0.85	1.07
HF	mg/Nm ³	< 0.23	NA	0.20	0.20	0.11	0.2	0.06	0.1	NA	
NO _x	mg/Nm ³	133.73	143.2	85	107	42.55	43.8	3.63	5.2	44.90	52.4
TVOC	mg/Nm ³	2.69	13.55	0.7	2	12.6	19.9	NA		NR	NR
VOCs	mg/Nm ³	NA		NA		NA		50	73	243	260
CO	mg/Nm ³	26.04	31.6	NA		NA		NA		12331	14178
PCDD/F	ng/Nm ³	0.090	NA	0.004	0.004	0.001	0.001 6	NA		NA	
Dioxins	ng/Nm ³	NA		NA		NA		0.003	0.014	0.03	0.03
Sampling frequency	number/ year	Continuous for dust and TVOC (5 for CO and NO _x , and 1 for PCDD, PAH, HF, HCl, SO _x and NH ₃)		10 (2 for PCDD/F, C _{org} , Hg and NO _x)		10 (2 for PCDD/F, C _{org} , Hg and NO _x)		5 (4 for dioxins, SO ₂ and NO _x)		9 (3 for NO _x , HCl and VOCs, and 1 for dioxins)	

NB: Abatement techniques applied:
I: Bag filter + regenerative thermal oxidiser (RTO).
J: Bag filter + adsorbent (activated carbon) + regenerative thermal oxidiser (RTO).
K: Bag filter + adsorbent (lignite coke).
L: Bag filter + adsorbent.
M: ESP + bag filter + adsorbent.
NA = Not available. NR = Not representative.
Source: [378, Industrial NGOs 2012]

The plant operating in France reported emissions before and after the implementation of the SDHL process. Table 6.49 gives a comparison of the SDHL process (from mid-2004 when the process was commissioned) with the traditional Waelz kiln process that was operating prior to this time.

Table 6.49: Emissions to air associated with the SDHL process before and after conversion

Component	Unit	Before*		After*		
		2003	2004	2005	2006	2007
SO ₂	kg/h	22148	7.390	0.584	0.424	0.199
NO _x	kg/h	2.140	1.143	0.946	2.467	1.407
VOCs - non-methane	kg/h	2.000	4.237	3.057	2.104	7.711
Dust	kg/h	0.070	0.129	0.204	0.181	0.193
HCl	kg/h	0.069	0.123	0.261	0.070	0.051
HF	kg/h	NA	0.124	0.027	0.346	0.065
Sum of metals	kg/h	0.0491	0.0317	0.0177	0.0257	0.0327
Pb	kg/h	0.0054	0.0133	0.0076	0.0102	0.0204
Zn	kg/h	0.0372	0.1191	0.0730	0.1065	0.2446
Hg	kg/h	NA	0.00445	0.00079	0.00148	0.00608
As	kg/h	NA	0.00053	0.00076	0.00089	0.00129
Cd	kg/h	0.0013	0.0011	0.0012	0.0007	0.0007
PCDD/F**	µg I-TEQ/h	9.653	7.235	1.141	2.567	1.292
Airflow	Nm ³ /h	113706	133977	131056	140781	148329
NA = not available						
* Annual mean value.						
** Before conducting an additional PCDD/F precipitation.						
Source: [378, Industrial NGOs 2012]						

Cross-media effects

No information provided.

Technical considerations relevant to applicability

Generally applicable to Waelz kilns. The use of a RTO may be limited for safety reasons.

Economics

No information provided.

Driving force for implementation

- Recovery of additional components from EAF dust.
- Less consumption of coke and gas.
- Higher throughput and higher zinc recovery.
- Reduction of CO₂ emissions (i.e. resource efficiency).

Example plants

Befesa plants in Freiberg and Duisburg (DE), Asua-Erandio (ES), Fouquières les Lens (FR), and IT.

Reference literature

[234, UBA (D) 2007], [246, France 2008], [351, COM 2009], [399, IZA 2012]

6.3.2.2.3.3 Techniques to prevent and reduce emissions from slag processing

Description

The technique to consider is the use of a bag filter (see Section 2.12.5.1.4).

Technical description

After passing the Waelz kiln, the fine-grained slag leaves the furnace at the kiln head and falls through a grid into a water bath or water-sprayed hopper for quenching. The cooled slag is transported out of the water bath to the slag storage place by a chain conveyor or an excavator. Emissions during the transfer out of the furnace and during cooling are caught by the exhaust

system at the kiln head or by an additional suction system. These off-gases are led to the waste gas treatment of the furnace off-gas or are treated separately in a fabric filter.

Achieved environmental benefits

Reduction of dust emissions to air.

Environmental performance and operational data

Bag filters have a typical outlet dust level of $< 5 \text{ mg/Nm}^3$.

Cross-media effects

Increase in energy use.

Technical considerations relevant to applicability

Generally applicable.

Economics

No information provided.

Driving force for implementation

- Reduction of emissions to air.
- Workplace health.

Example plants

Generally applied in Europe.

Reference literature

No reference literature provided.

6.3.2.2.3.4 Techniques to prevent and reduce waste water in the Waelz kiln process

Description

The technique to consider is countercurrent washing (two or three stages).

Technical description

The main source of waste water in the Waelz kiln process is the washing water which is used to wash halogens out of the Waelz oxide. The amount of waste water from Waelz oxide washing is reduced by applying a multi-step countercurrent washing process.

Figure 6.29 and Figure 6.30 show the overall processes for washing Waelz oxide. [[234, UBA \(D\) 2007](#)].

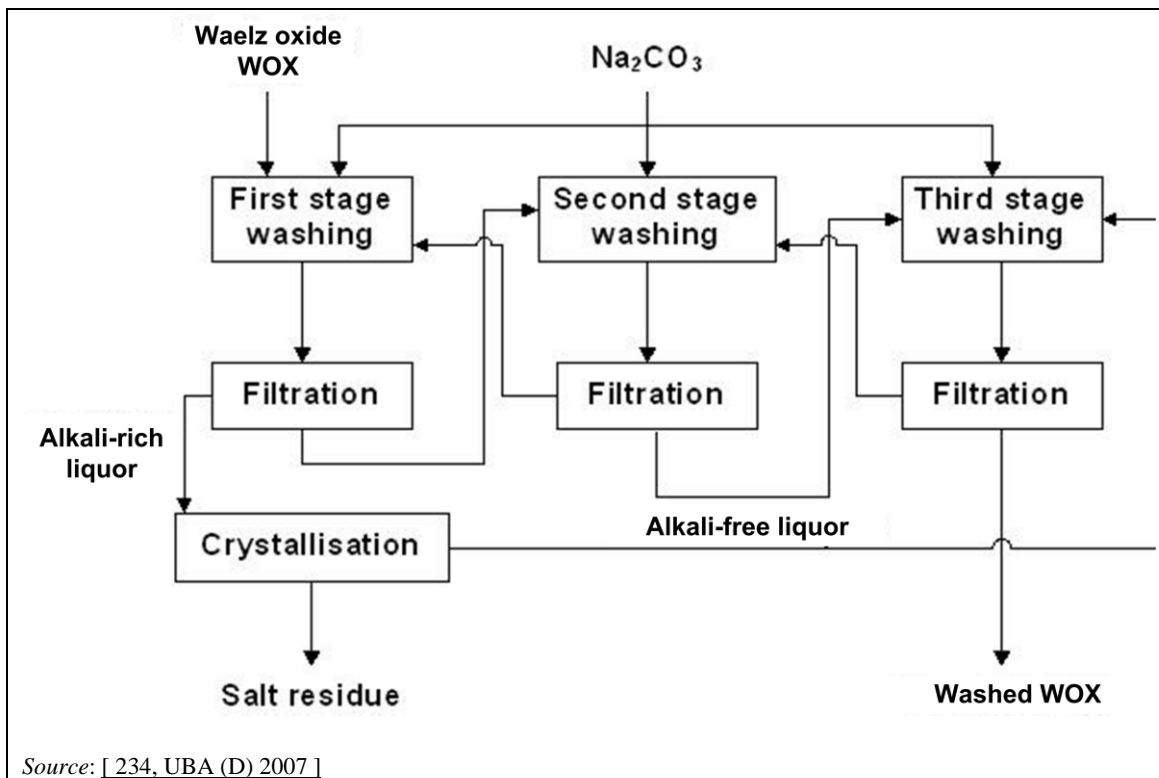

Figure 6.29: Diagram of a Waelz oxide three-stage countercurrent washing circuit

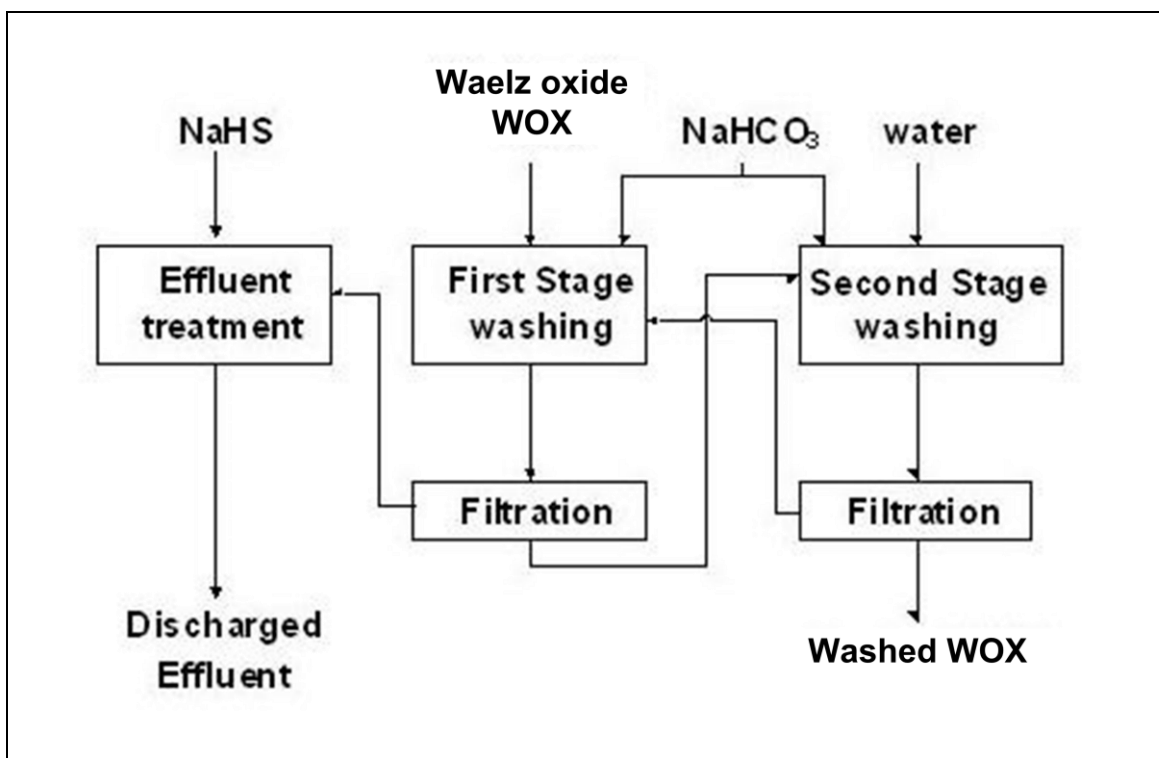

Figure 6.30: Diagram of a Waelz oxide two-stage countercurrent washing circuit

Achieved environmental benefits

- Up to three times less waste water is generated by countercurrent washing.
- A waste-water-free process is possible when applying the crystallisation process after washing.

Environmental performance and operational data

See technical description.

Cross-media effects

Increase in energy use (evaporation) when crystallisation is applied.

Technical considerations relevant to applicability

Generally applicable in Waelz kilns.

Economics

No information provided.

Driving force for implementation

- Reduction of waste water.
- Removal of halogens from Waelz oxide.

Example plants

Plants I, J, K, L and M.

Reference literature

[93, García-Agocheaga, B. 1998], [234, UBA (D) 2007], [399, IZA 2012]

6.3.2.2.3.5 Waste water treatment in the Waelz kiln process

Description

The techniques to consider are:

- crystallisation;
- precipitation;
- combined process (crystallisation and precipitation).

Technical description

Since the majority of the waste water is generated by the washing of the Waelz oxide, the waste water treatment is designed specifically to treat these waters. Other small waste water streams are added to the waste water treatment plant used for this purpose.

Crystallisation

One possibility to remove the alkalis and halogens of the rich leach liquor from the first washing step is to apply a crystallisation step in order to produce a salt residue and an alkali-free condensate. In the crystallisation step, 30–35 % of the total amount of halogens is removed. The salt residue is dumped or backfilled underground, and the treated effluent can be recycled to the washing plant. The condensate of the crystallisation step is recycled for a new washing step; ultimately, the total process can operate without producing waste water. [234, UBA (D) 2007].

Precipitation

When the halogen concentration of the waste water is acceptable for discharge into the receiving waters, another waste water treatment can be applied. Sulphur-containing additives, coagulants and flocculants are added in order to precipitate dissolved metals. After a filtration and neutralisation step, the treated effluent is discharged to the sewerage system or to a river/sea. Plant-specific data for Plant E are given in Table 6.52.

Combined process

When a limited amount of halogens can be discharged, a partial crystallisation step can be applied to remove some of the halogens. The remainder of the waste water is then treated by a precipitation process. Plant I reported a two-step waste water treatment. The first step is classic hydroxide precipitation. In the second step, a special liquid reagent, which is more efficient but

also more expensive than NaHS, is added to precipitate metal ions. Plant-specific data for Plant I are given in Table 6.52.

Achieved environmental benefits

Crystallisation

- Elimination of waste water.
- Partial removal of halides.

Precipitation

Removal of metals from the waste water (sulphide precipitation).

Combined process

- Partial elimination of waste water.
- Partial removal of halides.
- Removal of metals.

Environmental performance and operational data

The effect of washing and the typical composition of the waste water from the washing process are given in Table 6.50, Table 6.51 and Table 6.52.

Table 6.50: Effect of Waelz oxide washing

Component (%)	Unwashed Waelz oxide	Washed Waelz oxide (triple or double stage washing)
Zinc	58–63	63–68
Lead	7–10	9–11
Sulphur	0.5–1	< 0.15
Fluorine	0.4–0.7	0.08–0.15
Chlorine	4–8	0.05–0.15
K ₂ O	1.5–2	0.1–0.2
<i>Source: [234, UBA (D) 2007]</i>		

Table 6.51: Waste water from the Waelz oxide washing process

Component (mg/l)	Waste water after treatment with NaHS
Zinc	0.01–1.0
Lead	0.01–0.20
Cadmium	0.01–0.10
<i>Source: [234, UBA (D) 2007]</i>	

Table 6.52: Waste water from the Waelz oxide washing process

Plant		Q		I		M	
		Avg.	Max.	Avg.	Max.	Avg.	Max.
Flow	m ³ /h	195	NA	330	NA	28.2	NA
Zn	mg/l	0.04	0.46	0.03	0.06	1.43	5.28
Cd	mg/l	0.0020	0.024	0.0007	0.006	0.05	0.25
Pb	mg/l	0.0031	0.105	0.0067	0.019	0.68	2.76
As	mg/l	0.0123	0.2	< 0.001	< 0.001	0.17	0.64
Cu	mg/l	0.0003	0.0015	< 0.01	< 0.01	0.03	0.19
Fe	mg/l	0.06	0.18	< 0.05	< 0.05	0.3	0.46
Cr	mg/l	0.0015	0.0034	< 0.001	< 0.001	< 0.01	0.1
Cl-	mg/l	2780	5300	635	993	NA	NA
F-	mg/l	3.89	7	0.68	0.93	NA	NA
SO ₄ ²⁻	mg/l	996	1600	155	269	1994	2945

NB:
NA = not available
Plant Q: precipitation process.
Plant I: partial crystallisation to remove halogens + precipitation process.
Plant M: precipitation + flocculation + coagulation + filtration (emissions do not correspond to a direct discharge).
Source: [378, Industrial NGOs 2012]

Cross-media effects

Crystallisation

Increase in energy use (evaporation) and generation of solid waste or salt brine.

Precipitation

Use of chemicals for precipitation of metal ions.

Mixed process

- Increase in energy use (evaporation and generation of solid waste or salt brine).
- Use of chemicals for precipitation of metal ions.

Technical considerations relevant to applicability

The amount of crystallisation depends on local conditions. When the discharge of chlorides is not allowed, 100 % crystallisation is carried out. An example is the Befesa plant in Freiberg.

When a limited amount of chlorides can be discharged, partial crystallisation is applied, like at the Pontenossa plant in Italy, where about a third of the total amount of halogens contained in the Waelz oxide is removed in a crystallisation plant.

Economics

No information provided, but the process is in use and is economically viable.

Driving force for implementation

- Removal of metals (environmental legislation).
- Product optimisation.
- Reduction of fluorine, chlorine and alkali releases to receiving water body (local environmental legislation).

Example plants

- Crystallisation: Plant K.
- Precipitation: Plants Q and M.
- Mixed process: Plant I.

Reference literature

[93, García-Agocheaga, B. 1998] [234, UBA (D) 2007], [399, IZA 2012]

6.3.2.2.3.6 Techniques to prevent and minimise residues and wastes from the Waelz kiln process

No additional processes or equipment are used, only good process management.

6.3.3 Melting, alloying and casting of zinc ingots (primary, secondary, hydrometallurgical and pyrometallurgical processes)

6.3.3.1 Techniques to prevent and reduce emissions from melting, remelting, alloying, holding and casting furnaces and zinc dust production

Description

The techniques to consider are:

- operating equipment under negative pressure;
- bag filter (see Section 2.12.5.1.4).

Technical description*Operating equipment under negative pressure*

While adding fluxes or during the cleaning operations of the furnace, diffuse emissions of dust and fumes can occur. These diffuse emissions are not significant and are controlled by maintaining a negative pressure in the furnace, which is also intended to control and minimise the direct emissions.

Bag filter (see Section 2.12.5.1.4)

Bag filters are considered the best means of removal for particles of off-gases from these operations.

Table 6.53 shows both the diffuse and controlled emissions that can occur in these operations.

Table 6.53: Diffuse and controlled emissions in zinc hydrometallurgical processes

Emission	Physical state	Main contaminant
Dust	Particulate matter	Zinc oxide Zinc metal Zinc chloride
Fumes	Aerosol	Zinc oxide Zinc chloride Ammonia chloride

Electric furnaces, intended for melting the zinc cathodes, are equipped with a forced draught system that extracts a gaseous stream with the following typical characteristics for a furnace with a production capacity of 25 tonnes/h of zinc ingots:

- gas flow: 29 100 Nm³/h;
- temperature: 50 °C;
- dust: 1 g/Nm³;

- dust specific weight: 1.19 kg/l.

A typical composition of the extracted dust (and the dross produced) is:

- ZnO: 62–67 wt-%;
- ZnCl₂: 15–17 wt-%;
- Zn (metal): 19–22 wt-%.

Also, many zinc plants operate a small unit to make fine zinc powders. These powders are used in the purification process to precipitate more electropositive metals like Cu, Cd, Ni and Co (see Section 6.3.1.2.4).

Achieved environmental benefits

Reduction of emissions to air.

Environmental performance and operational data

Table 6.54 shows plant-specific data on emissions from melting and casting in zinc foundries.

Table 6.54: Emissions from zinc smelting and casting in zinc foundries (part 1)

Plant		A		A		A		B		C (F1)		C (F2)		C (F3)	
		Melting furnace		Casting line		Workspace ventilation									
Flow (average)	10 ³ Nm ³ /h	98		66		296		64		14		29		26	
		Avg.	Max.	Avg.	Max.	Avg.	Max.	Avg.	Max.	Avg.	Max.	Avg.	Max.	Avg.	Max.
Dust	mg/Nm ³	NA		NA		NA		1.3	3.2	1.3	2.6	0.3	0.5	0.3	0.3
Zn	mg/Nm ³	0.57	2.2	0.07	0.12	0.22	0.25	0.9	2.1	1.1	NA	0.2	NA	0.2	NA
NH ₄	mg/Nm ³	NA		NA		NA		3	7.4	NA		NA		NA	
Applied technique		Bag filter				None		Bag filter							
Sampling frequency	number/year	1		0.2		0.2		1		365		365		365	
NB: Some zinc foundries produce Zn-Ni alloys (typically 0.5–1.0 % Ni) and monitor Ni in the emissions. Plant C performs continuous measurements of dust; data provided as daily averages. NA = Not available. Source: [378, Industrial NGOs 2012]															

Table 6.55: Emissions from zinc smelting and casting in zinc foundries (part 2)

Plant		D	E	F		G		H		N	Z	
Flow (average)	10 ³ Nm ³ /h	112	104	35		30		45		NA	50	54
		Avg.	Avg.	Avg.	Max.	Avg.	Max.	Avg.	Max.	Avg.	Avg.	Max.
Dust	mg/Nm ³	0.18	0.419	0.25	1.1	3.9	4.5	2.66	NR	2.6	1.3	3.5
Zn	mg/Nm ³	0.37	0.293	0.17	0.74	NA		2	12	0.83	NA	
Ni	mg/Nm ³	0.0017	< LOD	NA		NA		N		NA	0.009	0.02
HCl	mg/Nm ³	0.92	NA	NA		NA		NA		NA	NA	
Applied technique		Bag filter										
Sampling frequency	number/year	2	3	12		12		2		1	2	
NB: Some zinc foundries produce Zn-Ni alloys (typically 0.5–1.0 % Ni) and monitor Ni in the emissions. NA = Not available. NR = Not representative. Source: [378, Industrial NGOs 2012]												

The data reported in the tables above show that bag filters enable dust values below 5 mg/Nm³ to be achieved, and half of the reporting plants report average values in the range of 0.2–0.5 mg/Nm³. A typical emission factor is < 7.5 g Zn/t of zinc produced.

Table 6.56 shows plant-specific data on emissions associated with zinc powder production.

Table 6.56: Emissions from zinc powder production

	Plant	B		C (F1)	C (F2)	C (F3)	C (F4)	F	
		Avg.	Max.	Avg.	Avg.	Avg.	Avg.	Avg.	Max.
Flow	Nm ³ /h	10 644		19 006	19 463	18 368	16 740	7 277	
Dust	mg/Nm ³	1.8	4.45	9.5	20.0	13.7	14.0	2.4	4.0
Zn	mg/Nm ³	1.43	3.57	9.5	19.9	13.6	13.9	2.3	4.0
Applied technique		Bag filter							
Sampling frequency	number/year	1		365	365	365	365	12	
NB: Plant C performs continuous measurements of dust; data provided as daily averages. Source: [278, Hunsiger et al 2007]									

Cross-media effects

Increase in energy use (electricity consumption).

Technical considerations relevant to applicability

Generally applicable.

Economics

No information provided.

Driving force for implementation

- Environmental regulatory requirements.
- Workplace health.

Example plants

Plant B, Plant C and Plant F.

Reference literature

No reference literature provided.

6.3.3.2 Techniques to prevent and minimise residues and wastes from the melting processes

Description

The internal and external recycling of residues and waste generated in the melting process and the application of a bag filter to abate emissions associated with zinc dross treatment.

Technical description

Internal and external recycling of residues and waste generated in the melting process

An example of the process to treat the wastes generated during the melting processes (zinc dross, zinc-bearing dust fumes and metallic drosses from cathode casting) is described below.

Zinc dross is transported in containers to the treatment plant. The containers are raised to the hopper-charging hole. The hopper has a screening grid to remove the bigger particles (metal). The rest of the dross is sent to a ball mill by means of a vibrating pipe feeding system. The

metal-rich portion of the dross is separated from the oxidised portion by means of a screening ball mill. If the chemical composition of these metallic particles is adequate, the metal-rich portion is remelted in the melting furnace. Alternatively, this metallic material can be sent to a zinc refining plant (e.g. of the New Jersey column variety), to obtain either zinc dust or zinc oxide.

After passing through the ball mill, the oxidised portion is transported to a container by means of a belt conveyor. The container is sent by lorry to the roasting plant where, after mixing with zinc concentrates, it is transformed into calcine ready to be used at the leaching section of the factory.

Zinc-bearing dust and fumes, as well as the dust isolated at the fabric filter, have characteristics and a composition similar to the oxidised portion isolated at the ball mill and, therefore, are also sent to the roasting furnace or can be used for the production of zinc chemicals (zinc oxide, zinc chloride, etc.).

Metallic drosses from cathode casting have characteristics and a composition similar to the metal-rich portion from the ball mill and, consequently, are treated jointly with it as described previously.

Figure 6.31 summarises the processes applied to the waste/residues produced during the zinc melting processes.

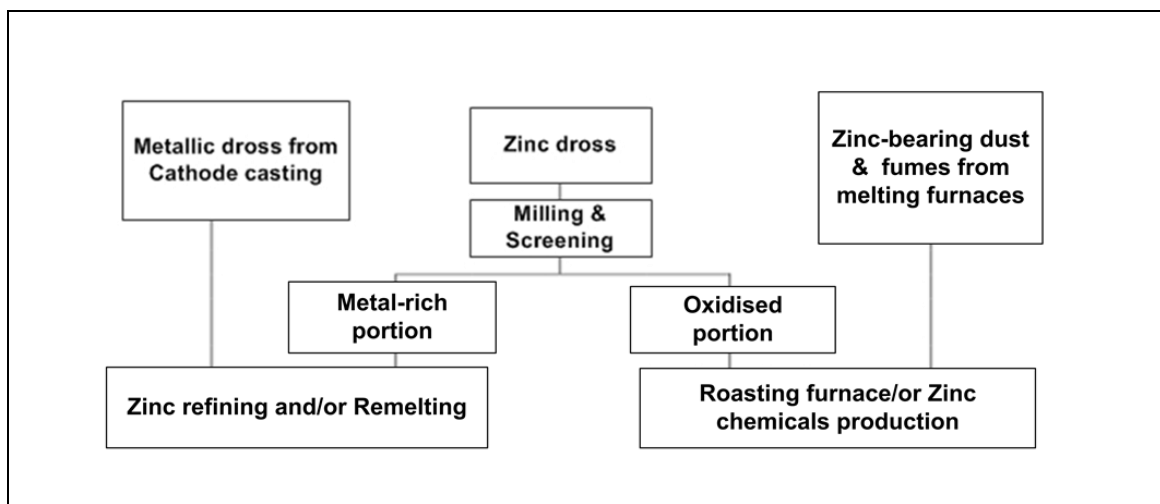

Figure 6.31: Flowsheet of a generic treatment for waste/residues produced during zinc melting

Bag filter

The ball mill, the hopper and all the transportation equipment are connected to a bag filter to remove any dust/fumes that may have been formed during the treatment process.

Achieved environmental benefits

Internal and external recycling of residues and waste generated in the melting process

Reuse of generated waste.

Bag filter

Reduction in diffuse emissions to air during zinc dross treatment.

Environmental performance and operational data

Bag filter

Table 6.57 gives plant-specific data on emissions during the mechanical treatment of zinc dross.

Table 6.57: Emissions from zinc dross milling in zinc foundries

	Plant	B		C		Q		F		H	
		Avg.	Max.	Avg.	Max.	Avg.	Max.	Avg.	Max.	Avg.	Max.
Flow	Nm ³ /h	16 310		30 369		9 507		9 371		35 000	
Dust	mg/Nm ³	0.45	1.11	1.25		0.42	1.05	0.53	2.6	4.5	4.65
Zn	mg/Nm ³	0.36	0.89	1.00	1.6	0.293	0.73	0.32	1.8	0.78	2.38
Applied technique		Bag filter									
Sampling frequency	number/year	1		1		3		12		2	
Source: [378, Industrial NGOs 2012]											

Cross-media effects

None reported.

Technical considerations relevant to applicability

Generally applicable.

Economics

No information provided.

Driving force for implementation

No information provided.

Example plants

Plant B, Plant C, Plant F, Plant H and Plant Q.

Reference literature

No reference literature provided.

6.3.3.3 Techniques to prevent waste water**Description**

Reuse of process water in cooling towers or other heat exchange systems.

Technical description

Water is used at zinc melting and casting units for the following purposes:

- cooling of casting moulds and ingots;
- cleaning operations.

The cooling of casting moulds and ingots is carried out using cooling water jackets through which water circulates without contacting the molten metal. These cooling devices are part of the walls and bottom of the mould. Water used for this purpose circulates in a closed circuit, as described later, in order to minimise losses. In addition, the surfaces of large ingots are often cooled by spraying water over their upper surface. This sprayed water is evaporated and is therefore not recovered.

To minimise water use, and consequently the waste water volume, after leaving the casting line the used water is sent to a heat exchange system, which in most cases consists of forced draught cooling towers. Air and water are circulated countercurrently and the water temperature decreases, allowing its reuse for cooling and/or other purposes. As a consequence of this process, the only water losses that occur are due to evaporation at the cooling tower. The quantification of said losses will depend on the local atmospheric conditions and cannot be

evaluated generally. Other heat exchange systems can be used depending on the local conditions, such as heat exchangers using water from rainwater ponds, but for this specific case cooling towers are the most economic procedure for recycling water after it is used at casting lines. The water used to cool the casting line is clean and warm and it is also reused in the hydrometallurgical process.

Water used for cleaning purposes can be polluted. Its total volume is not usable and, before its discharge, it must be treated in the general waste water treatment plant of the factory.

Achieved environmental benefits

No waste water from mould cooling.

Environmental performance and operational data

No information provided.

Cross-media effects

No information provided.

Technical considerations relevant to applicability

No information provided.

Economics

No information provided.

Driving force for implementation

No information provided.

Example plants

No information provided.

Reference literature

No reference literature provided.

6.3.4 Treatment of waste water from zinc production plants (primary, secondary, hydrometallurgical and pyrometallurgical processes)

As described before, in a vast number of installations, cooling water and treated waste water including rainwater, water from landfill control and water from soil remediation, etc. are reused or recycled within the processes. Some waste water streams can remain and need to be treated to remove dissolved metals and solids, before discharge. Traditionally a hydroxide/carbonate precipitation is carried out. In some cases, a combined or a two-stage precipitation process is used with a hydroxide stage followed by a sulphide stage. The additional sulphide stage ensures the reduction of metals to a lower concentration than that achieved by hydroxide precipitation [168, Steil, H.U. et al. 1999]. The techniques listed in Section 2.12.6.2 are the techniques to consider.

6.3.4.1 Treatment of waste water from hydrometallurgical and pyrometallurgical zinc production

Description

The techniques to consider are:

- pretreatment of certain waste water streams (e.g. weak acid bleed from the cleaning of the roaster's wet gas) prior to sending them to the waste water treatment plant;

- waste water treatment plant based on an inorganic process (hydroxide precipitation followed, if necessary, by sulphide precipitation) (see Section 2.12.6.2);
- waste water treatment plant based on a biological process (see Section 2.12.6.2).

Technical description

Typically, in zinc plants most waste waters containing metals, sulphates and/or other elements that are not suitable for reuse in the process (see Section 6.3.1.2.6) are collected and eventually treated in a central waste water treatment plant (WWTP).

Pretreatment

A typical example of pretreatment is that performed on the weak acid bleed from the cleaning of the roaster's wet gas. This water is aerated so that part of the dissolved SO₂ is extracted. This SO₂ flow is added to the main gas flow from the roaster so that this SO₂ is recovered as well, while the amount of sulphides/sulphates that need to be treated in the WWTP is reduced too. Also, spontaneously formed mercury- and/or selenium-containing solid compounds can be present in the weak acid bleed. Removing this sludge (in a settler or filter) before the stream is sent to the central WWTP is a way to unburden the WWTP process.

The assessment of whether or not it is best to pretreat certain waste water streams can only be made on a case-by-case basis as the decisive parameters can be site- or region-specific (e.g. effluent discharge conditions, waste composition restrictions for landfilling or processing).

Also, when precipitation is applied in two or more stages (see below), it can sometimes be beneficial not to collect all the waste waters in one circuit, but to make a distinction between two (or more) 'families', for example heavily loaded waters (e.g. bleed from the cleaning of the roaster's wet gas) and slightly loaded waters (e.g. rainwater run-off). In this case, the latter can enter the process after the first stage, which can be beneficial with regards to overall performance and operating costs. Again, this must be evaluated on a case-by-case basis (e.g. the cost of a double sewer system depends to a great extent on the plant's layout).

Waste water treatment plant

For a zinc plant with an annual production capacity of 250 kt, the total flow to be treated in the central WWTP is of the order of 100–300 m³/h. Only techniques that are capable, from a technical and expenditure point of view, of treating high flows are applied.

In the inorganic process as well as in the biological process, the main goal is to precipitate metals and other compounds as insoluble or barely soluble compounds, in one or more steps. The solids are separated from the water flow by settling and/or filtering in one or more stages.

Waste water treatment plant based on an inorganic process

Typically, hydroxide precipitation is applied. By adjusting the pH to a value in the range of 9 to 10.5, usually by adding alkaline reagents such as lime or sodium hydroxide because most waste water flows are acidic, metals are precipitated as hydroxides. Usually this neutralisation and precipitation step is performed at one pH value; in some cases, it is done in two or more stages where different pH values can be applied.

The general equation for hydroxide precipitation is:

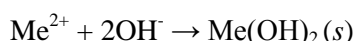

Almost all waste waters from a zinc plant contain significant amounts of sulphates and have a low pH (as they contain sulphuric acid). By adding lime (quicklime, caustic lime) to neutralise and to precipitate hydroxides, sulphates are simultaneously removed from the water as gypsum (until the equilibrium level is reached around 1.6 g/l sulphate):

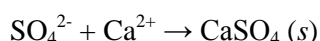

In some cases, the hydroxide precipitation is combined with or followed by sulphide precipitation through the addition of NaHS or Na₂S for example (simultaneous precipitation in the same reactor, such as multistage precipitation). As the solubility of metal sulphides is lower than that of the corresponding metal hydroxide, the sulphide stage is capable of removing metals to a lower concentration than that achieved by hydroxide precipitation.

The general equation for sulphide precipitation is:

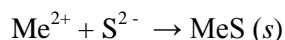

Hydroxide and/or sulphide precipitation is the core of the waste water treatment operations. However, in some specific cases, additional steps are added to remove elements that are insufficiently removed. Whether or not this is required depends on the site-specific situation (e.g. presence of typical elements, stringent emission standards). Some reported examples: fluorine can be partially precipitated as CaF₂ through addition of lime or another calcium source at pH 9.5, and arsenic can be partially removed by co-precipitation through addition of iron(III) salts.

Solid-liquid separation is normally done by means of settling in a cylindrical settler, lamella settler or another type of settler (i.e. thickener, decantation tank, clarifier, sedimentation tank). In some cases it is completed with a filtering operation (e.g. sand filter). To improve settling and/or filtering characteristics, flocculant-coagulant additives can be used.

The inorganic process is the most commonly used in EU hydrometallurgical zinc plants. The only pyrometallurgical zinc plant operating in the EU also applies this process.

Waste water treatment plant based on a biological process

One European plant uses a biological process to produce sulphide ions *in situ*. Weak acid, which is the bleed from the wet gas cleaning, has a high sulphate concentration (10–25 mg/l) and is treated first. The sulphate ions are reduced to sulphide ions (S²⁻, HS⁻) with hydrogen gas and sulphate-reducing bacteria in a biological waste water treatment plant:

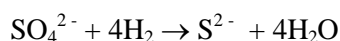

The hydrogen is produced from natural gas and steam in a reformer unit. The zinc and other metals react with the sulphide ions and precipitate as a metal sulphide:

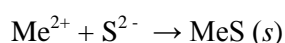

So the overall reaction is:

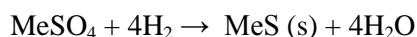

Sulphate and metal concentrations after this treatment are still too high to be discharged directly and the water is treated in another step together with other waste water from production (as well as groundwater from remediation activities). This also uses sulphate-reducing bacteria to precipitate metals with sulphide, but in this case ethanol is used as the electron donor instead of hydrogen. In this case the overall reaction is:



Because elevated concentrations of free metals in the waste water streams are toxic for the sulphate-reducing bacteria, the reactor has to produce an excess of sulphide. As the free sulphide concentration in the discharged water has to be low, an aerobic biological reactor is used to convert the remaining sulphide ions into elementary sulphur:

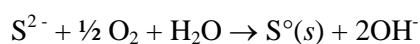

All the metal sulphides and biomass sludge are recycled to the roasting stage to recover metals in the zinc production sections, and the sulphur as sulphuric acid.

Achieved environmental benefits

- Reduction of metal emissions to water. The metal contents of the effluent of a biological process are similar to those of the cleaned water of the best-performing waste water treatment based on inorganic sulphide additions (NaHS, Na₂S), mainly as the chemistry behind both processes is fundamentally the same (based on the low solubility of metal sulphides).
- Reduction of sulphate emissions to water. The biological process has an additional positive effect in that the sulphate content of the treated water is reduced. Sulphate concentrations of around 600 mg/l can be reached versus concentrations of around 1600 mg/l in a classical inorganic WWTP process.

Environmental performance and operational data

Table 6.58 shows plant-specific data on emissions to water from RLE plants (averages over the samples obtained over a year and maximum daily averages within a year).

Table 6.58: Emissions to water from RLE plants (part 1)

Plant		A		B		C		D Leaching + Mg & Mn purge		D Leaching + rainwater		D H ₂ SO ₄ plant	
Flow	m ³ /h	110–145		248		257.4		84.6		81.4		5.8	
		Avg.	Max.	Avg.	Max.	Avg.	Max.	Avg.	Max.	Avg.	Max.	Avg.	Max.
Zn	mg/l	0.02–0.25	0.25	0.17	0.34	2.3	3.5	0.8	1.66	0.39	0.92	0.18	0.37
Cd	mg/l	< 0.004	0.004	0.0018	0.005	0.013	0.13	0.01	0.027	0.02	0.0352	0.01	0.0065
Pb	mg/l	NR	NR	0.002	0.015	0.035	0.107	0.022	0.031	0.029	0.05	0.033	0.064
Hg	mg/l	< 0.00025	NR	0.0001	NR	0.001	0.0026	0.0001	0.0002	0.0001	0.0001	0.001	0.0017
As	mg/l	0.005–0.01	0.01	0.0011	0.003	0.008	0.012	0.002	0.002	0.002	0.002	3.6	11.51
Cu	mg/l	< 0.05	< 0.05	0.0004	NR	0.006	0.01	0.005	0.012	0.006	0.013	0.009	0.024
Ni	mg/l	0.1–0.4	0.4	0.002	0.017	0.005	0.005	NR	NR	NR	NR	NR	NR
Fe	mg/l	1.2–2.9	2.9	0.85	1.9	0.2	0.2	NR	NR	NR	NR	NR	NR
Co	mg/l	0.1–0.3	0.3	0.0001	0.002	NR	NR	NR	NR	NR	NR	NR	NR
Cr	mg/l	NR	NR	0.003	NR	NR	NR	NR	NR	NR	NR	NR	NR
SO ₄ --	mg/l	NR	NR	574	NR	NR	NR	NR	NR	NR	NR	NR	NR

NB: Abatement techniques applied are:
Plant A: pH control with Ca(OH)₂ precipitation, sulphide precipitation with Na₂S, filter (common WWTP with Co-Ni-Cu plant next door).
Plant B: pH control with Ca(OH)₂ precipitation, biological reduction of sulphates to sulphide, settler.
Plant C: pH control with Ca(OH)₂ precipitation, flocculation, sand filter.
Plant D: pH control with Ca(OH)₂, sulphide precipitation with Na₂S, sand filter.
Plant D: pH control with Ca(OH)₂, sulphide precipitation with Na₂S, sand filter.
Plant D: sulphide precipitation with Na₂S + CuSO₄, pH control with NaOH + Na₂S, filtration.
NR = Not reported.
Source: [378, Industrial NGOs 2012]

Table 6.59: Emissions to water from RLE plants (part 2)

Plant		E	F		G		H	I	
Flow	m ³ /h	195	42		350		NR	330	
		Avg.	Avg.	Max.	Avg.	Max.	Avg.	Avg.	Max.
Zn	mg/l	0.04	0.04	0.1	0.56	2.5	0.39	0.03	0.06
Cd	mg/l	0.002	0.0012	0.0024	0.066	0.1	0.02	0.0007	0.006
Pb	mg/l	0.0031	0.013	0.029	0.091	0.3	0.02	0.0067	0.019
Hg	mg/l	NR	0.0006	0.0017	< 0.001	NR	NR	0.0002	0.00032
As	mg/l	0.0123	0.019	0.093	< 0.001	0.001	NR	< 0.001	< 0.001
Cu	mg/l	0.0003	0.005	0.005	0.02	0.05	0.05	< 0.01	< 0.01
Ni	mg/l	NR	0.005	0.005	NR	NR	NR	< 0.001	0.002
Fe	mg/l	0.06	0.04	0.077	0.04	0.2	0.09	< 0.05	< 0.05
Cr	mg/l	0.0015	0.005	0.005	NR	NR	NR	< 0.001	< 0.001
SO ₄ --	mg/l	996	NR	NR	650	1200	650	155	269
Sb	mg/l	0.002	NR	NR	NR	NR	NR	NR	NR

NB: Abatement techniques applied are:
Plant E: pH control with Ca(OH)₂, sulphide precipitation with Na₂S, settling, filtration.
Plant F: pH control with NaOH, sulphide precipitation with Na₂S, settling, filtration.
Plant G: pH control with NaOH, sulphide precipitation with Na₂S, settling, filtration.
Plant H: Waste water goes to a consortium waste water treatment plant.
Plant I: pH control with Ca(OH)₂ or H₂SO₄, special (undisclosed) chemical precipitation, flocculation, settling.
Plants E and I have a higher Cl content because of the waste water from Waelz oxide washing.
The amount of rainwater can vary a lot between plants. For example, annual precipitation in Plant D amounts to 2000 mm compared to 600 mm in Plant F.
When the settling capacity is too low, fine precipitated solids can be left in the discharge of the WWTP. During periods of rain, the flow of waste water is higher and the settling time is shorter.
NR = not reported.
Source: [378, Industrial NGOs 2012]

Table 6.60 shows plant-specific data on emissions to water from the only ISF plant in the EU.

Table 6.60: Emissions to water from an ISF plant

	Unit	Plant O
Zn	mg/l	0.70
Cd	mg/l	0.12
Pb	mg/l	0.12
Tl	mg/l	0.68
Cl-	mg/l	970
SO ₄ ²⁻	mg/l	770

NB: Abatement techniques applied are pH control with Ca(OH)₂ precipitation, and sulphide precipitation with Na₂S settler.
Waste water streams come from process waste water, rainwater and water from the dumping area.
Source: [378, Industrial NGOs 2012]

Emissions were also reported from a plant in Japan producing secondary zinc via the solvent extraction process (see Table 6.61).

Table 6.61: Emissions to water from secondary zinc production using solvent extraction

Waste water from solvent extraction		
	Unit	Plant in Japan
Zn	mg/l	< 0.2
Pb	mg/l	< 0.02
Cu	mg/l	< 0.5
Cd	mg/l	< 0.05
F	mg/l	3.3
COD	mg/l	4.7
TSS	mg/l	3.7
<i>Source: [378, Industrial NGOs 2012]</i>		

Cross-media effects

Waste water treatment plant based on an inorganic process

- Use of neutralising agents (lime, sodium hydroxide), sulphide sources (NaHS, Na₂S) and flocculants.
- Waste production.

Waste water treatment plant based on a biological process

- Use of neutralising agents (lime, sodium hydroxide) and flocculants. A smaller quantity of neutralising agents than in the inorganic process is needed.
- Use of natural gas, ethanol or other carbon sources.
- Increase in energy use (a minimum temperature of about 30 °C must be ensured).

Technical considerations relevant to applicability

Waste water treatment plant based on an inorganic process

Common technique, therefore the know-how is relatively easily accessible.

Waste water treatment plant based on a biological process

This process is more complicated and more sensitive than the inorganic version. This, and the fact that a minimum temperature of about 30 °C must be guaranteed, lowers this technique's overall applicability; a site-specific evaluation is required.

Economics

Waste water treatment plant based on an inorganic process

No information provided but the technique is used industry-wide.

Waste water treatment plant based on a biological process

No information provided. Investment costs and direct operational costs are higher than for a similar inorganic version, but the one plant in the EU operates viably.

Driving force for implementation

Reduction in emissions of metals and other pollutants to water.

Example plants

- Biological process: Nyrstar Budel (NL).
- Inorganic process: all other European zinc plants.
- Precipitation with a special (undisclosed) chemical: Plant I.

Reference literature

[319, Boonstra 2003], [320, Huisman 2004], [401, Houten et al. 2009], [402, Buisman et al. 1999]

[319, Boonstra 2003], [320, Huisman 2004], [401, Houten et al. 2009], [402, Buisman et al. 1999]

6.3.5 Cadmium production and recycling routes

6.3.5.1 Hydrometallurgical cadmium production

6.3.5.1.1 Techniques to prevent and reduce emissions from leaching and solid-liquid separation

Description

The techniques to consider are:

- central suction system;
- wet scrubber (see Section 2.12.5.2.2).

Technical description

In the case of a specific section dedicated to the production of cadmium, all the equipment is connected to a central suction system, and the exhaust gas is treated in a wet scrubber. The scrubbing solution bleed is returned to the zinc leaching section [234, UBA (D) 2007].

Achieved environmental benefits

Prevention and reduction of emissions to air.

Environmental performance and operational data

Data for Plant F are reported in Table 6.29 as, in this case, the reactors of the hydrometallurgical plant are connected to a central scrubber that covers the zinc solution purification reactors, the cadmium plant reactors, cadmium cementation and pelletising and the copper residue treatment reactor.

Cross-media effects

None reported.

Technical considerations relevant to applicability

Applicable to specific cadmium leaching sections.

Economics

No information provided.

Driving force for implementation

- Reduction of emissions to air.
- Occupational health.

Example plants

Plants in BE, BG, DE, NL and PL.

Reference literature

No reference literature provided.

6.3.5.1.2 Techniques to prevent emissions from electrolysis

Description

Covering of cells with a plastic tarpaulin or individual strips.

Technical description

Similarly to in the zinc electrolytic process, but on a smaller scale, cadmium is deposited from the purified cadmium sulphate solution onto aluminium starting cathodes and oxygen is formed at the anodes. Oxygen bubbles that burst at the surface can form an acid mist (aerosol). To reduce these mist emissions, the cells can be covered with a plastic tarpaulin or individual plastic cover strips can be placed over/between the electrodes.

Diffuse dust emissions can be reduced by good housekeeping, e.g. ensuring that spills of cadmium-containing liquids and solids are cleaned up without delay, keeping the floor wet in (part of) the area.

Achieved environmental benefits

Prevention of acid mist emissions and diffuse dust emissions.

Environmental performance and operational data

No Information provided on the specific contribution of the techniques mentioned.

Cross-media effects

None reported.

Technical considerations relevant to applicability

Generally applicable at any cadmium cell house.

Economics

The investment cost for plastic covers is relatively limited.

Driving force for implementation

- Prevention of emissions to air.
- Occupational health.

Example plants

Nyrstar Budel (NL).

Reference literature

No reference literature provided.

6.3.5.1.3 Techniques to prevent and minimise residues and wastes from hydrometallurgical cadmium production

Description

Recovery or precipitation of the cadmium-rich cementate from hydrometallurgical zinc production.

Technical description

Recovery

This consists of extracting the cadmium from the zinc process as a cadmium-rich cement in the purification section, to further concentrate and refine it (electrolysis or pyrometallurgical process) and finally transform it into marketable cadmium metal or cadmium compounds.

Precipitation

This consists of extracting the cadmium from the zinc process as a cadmium-rich cement in the purification section, to apply a set of hydrometallurgical operations in order to transform the cadmium into a cadmium-rich precipitate (e.g. cement (Cd metal), $\text{Cd}(\text{OH})_2$) that is landfilled under strictly controlled conditions.

Achieved environmental benefits*Recovery*

Waste-free process.

Precipitation

Apart from the targeted cadmium waste for landfilling, the process is waste-free: all process flows are recycled in the cadmium section or in the zinc plant flow. The volume of residue to be landfilled is relatively limited, as the process is run in such a way that its cadmium concentration is high (at least 20 %). The landfilling conditions are in line with the relevant legislation. This often means that the residue needs to be stabilised (e.g. adding lime), on site or at the landfill facilities, in order to improve its physical properties (e.g. leachability).

Environmental performance and operational data

The percentage of cadmium-rich precipitate sent to landfill depends on market demand.

Cross-media effects*Recovery*

- Use of reagents. Cementation of cadmium in the purification or in the cadmium section requires zinc powder (1.1–1.6 times the stoichiometric amount according to the reaction $\text{Cd}^{++} + \text{Zn} \rightarrow \text{Cd} + \text{Zn}^{++}$).
- Increase in energy use (electricity is required in electrolysis and melting/casting to transform cadmium into its metallic form).

Precipitation

- Use of reagents. Cementation of cadmium in the purification or in the cadmium section requires zinc powder (1.1–1.6 times the stoichiometric amount according to the reaction $\text{Cd}^{++} + \text{Zn} \rightarrow \text{Cd} + \text{Zn}^{++}$). Besides, precipitation of cadmium in a non-metallic form (e.g. as a hydroxide) requires the addition lime or NaOH.
- A concentrated cadmium waste is generated.

Technical considerations relevant to applicability

From a process point of view, the recovery process is a more complex and less robust process than precipitation: the cadmium sulphate solution must be purified before it can be processed in the electrolysis section, while the quality requirements for a cadmium sulphate solution from which a waste residue will be precipitated are less stringent.

The equipment required in the recovery process (reaction tanks, settlers, electrolytic cells, melting furnace, casting equipment) is significantly more comprehensive than in the precipitation one (reaction tanks, settlers, filter).

Which of these two options a plant opts for largely depends on market conditions (i.e. the cadmium market is too small to use all the cadmium that could theoretically be produced), landfilling possibilities/conditions, and the availability of the required equipment and expertise, etc. These conditions can be site- or region-specific and can change over the course of time.

Economics

No quantitative data available but the cost and benefits of both options strongly depend on market conditions (cadmium price, short versus long market), landfilling possibilities/conditions (price, distance to landfill), investment costs and operational costs (manpower, energy, reagents). These conditions can be quite site- or region-specific and can change over the course of time.

Driving force for implementation

The driving forces for implementing one of these two options are:

- profitability/cost in the short and long term;
- environmental impact (waste creation/avoidance, electricity and reagents use);

- ability to comply with environmental and human health legislation.

Example plants

- Recovery: Plant B, Plant D and Plant F.
- Precipitation: Plant A (stored in concrete bunker), Plant E (landfilled waste stream is cadmium hydroxide), and Plant P (landfilled waste stream is a cadmium-rich cement).

Reference literature

No reference literature provided.

6.3.5.2 Pyrometallurgical cadmium production

6.3.5.2.1 Techniques to prevent and reduce emissions from the cadmium plant in pyrometallurgical zinc production (ISP)

Data from Plants B, D and F are reported in Section 6.3.5.3.

6.3.5.2.2 Techniques to prevent and reduce emissions from briquetting and pelletising metallic cadmium cements

Description

The techniques to consider are:

- central suction system;
- wet scrubber (see Section 2.12.5.1.6).

Technical description

The cadmium sulphate solution is pumped into the cadmium precipitation tank. Zinc powder is added and the cadmium is precipitated in the form of small pellets. The pellets are separated from the solution in a Nutsche filter, washed and pressed to briquettes in a hydraulic press. The briquettes are collected in closed containers for transport to the cadmium refinery. The cadmium content is > 98 %. The depleted solution is recycled to the zinc leaching section.

The equipment is connected to a central suction system and the exhaust gas is treated in a wet scrubber. The scrubbing solution bleed is used in the zinc leaching section.

Achieved environmental benefits

Reduction of dust emissions.

Environmental performance and operational data

Data for Plant F are reported in Table 6.29 as, in this case, the reactors of the hydrometallurgical plant are connected to a central scrubber that covers the zinc solution purification reactors, the cadmium plant reactors, cadmium cementation and pelletising and the copper residue treatment reactor.

Cross-media effects

No information provided.

Technical considerations relevant to applicability

No information provided.

Economics

No information provided.

Driving force for implementation

Environmentally safe process to operate at a reasonable cost.

Example plants

Plant F.

Reference literature

No reference literature provided.

6.3.5.2.3 Techniques to reduce emissions from cadmium recovery by fuming/condensation**Description**

The techniques to consider are:

- bag filter (see Section 2.12.5.1.4);
- ESP (see Section 2.12.5.1.1);
- wet scrubber (see Section 2.12.5.1.6).

Technical description

In the low-temperature route, cadmium briquettes (produced in a process described in Section 6.3.5.2.2) are melted in a furnace under a blanket of caustic soda. Dross is removed and cast into small ingots. The liquid cadmium is transferred to the refining furnace.

In the refinery furnace, the molten cadmium is treated with caustic soda to remove the zinc. The mixture is stirred for several hours. Then the stirrer is switched off and the dross is removed and cast into small ingots. The metal now contains > 99.5 % cadmium and is transferred to the vacuum distillation.

In the vacuum distillation, cadmium is separated from components that have a lower vapour pressure. The distillation unit is kept under vacuum and the metal is evaporated at a temperature close to the melting point. The less volatile components condense and flow back to the furnace. High-grade cadmium is collected as condensate and cast into ingots.

All the cadmium refinery equipment is connected to a central suction system. In Plant F, the exhaust gas is treated in an ESP before release to the environment. The collected dust is periodically washed out of the ESP with water. The effluent is used in the zinc leaching section. Plant B uses a scrubber and Plant D a bag filter.

Achieved environmental benefits

Reduction of dust emissions to air.

Environmental performance and operational data

Data from Plants B, D and F are reported in Section 6.3.5.3, since both off-gases are treated with the same abatement device.

Table 6.62 shows the cadmium outlet distribution for Plants B, E (the final refining of cadmium from Plant E takes place in Plant B) and F (hydrometallurgical/vacuum distillation route for cadmium production).

Table 6.62: Distribution of cadmium output from European zinc refinery plants

Input (%)	Plant B	Plant E	Plant F
Cadmium metal recovered	90.4	14	Approx. 70
Cadmium as impurity in by-products (Cu and Pb-Ag concentrates)	9.4	41	20–25
Cadmium disposal	Not reported	35 (Cd waste) + 5 (goethite)	5–10 (Jarofix)
Cadmium to disposal with WWTP sludge	0.1	5	Approx. 0.1
Cadmium in emissions to air	< 0.01	< 0.01	< 0.01
Cadmium in emissions to water	< 0.01	< 0.01	< 0.01

Cross-media effects

No information provided.

Technical considerations relevant to applicability

- Technique only valid when there is a demand for pyrometallurgically refined cadmium.
- For waste-free operation, the process should be integrated in a hydrometallurgical zinc refinery.

Economics

No information provided.

Driving force for implementation

No information provided.

Example plants

Plants B, E and F.

Reference literature

No reference literature provided.

6.3.5.2.4 Techniques to prevent and minimise residues and wastes from pyrometallurgical cadmium production

All residues are internally or externally recycled/reused.

6.3.5.3 Melting, alloying and casting of cadmium ingots (primary and secondary loops)

6.3.5.3.1 Techniques to prevent and reduce emissions from melting, remelting, alloying, and holding and casting furnaces

Description

The techniques to consider are:

- bag filter (see Section 2.12.5.1.4);
- ESP (see Section 2.12.5.1.1),
- wet scrubber (see Section 2.12.5.1.6).

Technical description

High-grade cadmium is manually cast from the furnace for refined cadmium into balls, sticks or other formats. The castings are cut and packed into plastic-lined cardboard boxes or into big bags. The casting and cutting scrap is melted in a special furnace and recast.

The furnaces are connected to a central suction system. The exhaust gas is treated in a scrubber or an ESP before release to the environment. The collected dust is periodically washed out of the ESP with water. The effluent is used in the zinc leaching section. Similarly, bleed from the scrubber can be treated in the zinc plant.

Dross from the melting furnaces is recycled to the zinc plant.

Achieved environmental benefits

- No waste.
- Very low emissions with an ESP.

Environmental performance and operational data

Table 6.61 shows plant-specific data on emissions from different cadmium processes.

Table 6.63: Emissions from cadmium melting, remelting, alloying, and holding and casting furnaces

Plant		B		D		F	
		Avg.	Max.	Avg.	Max.	Avg.	Max.
Flow	Nm ³ /h	4 950	NR	10 087	NR	7 500	NR
Dust	mg/Nm ³	0.106	0.264	1.5	2.5	0.06	0.19
Cd	mg/Nm ³	0.093	0.232	0.090	0.16	0.001	0.006
Applied technique		Scrubber		Bag filter		ESP	
Sampling frequency	number/year	1		1		12	
Cd process		Cathode melting		Soda smelting		Soda smelting & Vacuum distillation	
NB: NR = not reported Source: [378, Industrial NGOs 2012]							

Cross-media effects

No information provided.

Technical considerations relevant to applicability

No information provided.

Economics

No information provided.

Driving force for implementation

- Environmental legislation.
- Workplace health.

Example plants

Plants B, D and F.

Reference literature

No reference literature provided.

6.3.5.3.2 Techniques to prevent and minimise residues and wastes from the melting process

There are no waste products in the melting process. All intermediate residues are recycled in the process.

6.3.5.3.3 Techniques to prevent waste water

Description

Prevention of waste water from cadmium casting.

Technical description

No waste water originates from this production route.

All solutions are handled in a closed circuit. The effluent of the wet scrubber is used in the zinc leaching section.

Cooling water is not applied.

Achieved environmental benefits

No waste water.

Environmental performance and operational data

No waste water.

Cross-media effects

No information provided.

Technical considerations relevant to applicability

No information provided.

Economics

No information provided.

Driving force for implementation

Minimisation of cadmium emissions to the environment.

Example plants

Plants B, D and F.

Reference literature

No reference literature provided.

6.3.5.4 Treatment of waste water from cadmium production plants (primary, secondary, hydrometallurgical and pyrometallurgical processes)

Description

Treatment of waste water from cadmium production plants.

Technical description

When the cadmium metallurgical plant is integrated with a zinc metallurgical plant, all waste water streams from the cadmium section are eventually treated in the common waste water treatment plant (see Sections 6.3.4 and 2.12.6.2).

When the cadmium section is not integrated in a zinc production unit and when the process is designed with a final release to the receiving water body, the same techniques as above apply with, potentially, additional absorption columns (when total flow allows).

Achieved environmental benefits

Low cadmium release to the receiving water body.

Environmental performance and operational data

No information provided.

Cross-media effects

- Use of reagents.
- Final residues inertised and landfilled.

Technical considerations relevant to applicability

Local conditions determine the applicability.

Economics

No information provided.

Driving force for implementation

Compliance with the Water Framework Directive and national regulations.

Example plants

Plants in BE, NL, FR, DE, BG, PL, SE and NO.

Reference literature

No reference literature provided.

6.4 Emerging techniques

Process to increase metal recovery from the Waelz slag (i-Meltor™)

It consists of processing the Waelz slag in an adapted AC electric arc furnace to extract metals and pig iron. The process is similar to the one applied to recover zinc from electric arc furnace dust in the steel industry.

So far, it has been tested in several European Waelz kilns, but it is still not economically competitive due to the increased energy costs that it entails.

The use of this process involves implementing complementary air abatement techniques, such as a post-combustion chamber, dry scrubber and dedusting systems.

SX-EW system for zinc recovery from EAF dust

A SX-EW system for zinc recovery from EAF dust has been reported.

Leaching processes based on chloride for zinc and lead recovery

Leaching processes based on chloride for zinc and lead recovery are reported as being at the demonstration stage [202, Fundación Entorno, Empresa y Medio Ambiente 1999].

Plasma burner for secondary zinc materials

The use of a plasma burner for secondary zinc materials has been reported.

Thermal treatment of jarosite and goethite

The thermal treatment of jarosite and goethite has been demonstrated in the Outotec process, [98, Lijftogt, J.A. et al 1998]. Zinc and other volatile metals are fumed off and recovered, and the slag produced could be suitable for construction purposes. The processes have not been shown to be economically viable as a general residue treatment method though.

The injection of fine material via the tuyères of a blast furnace has been successfully used and reduces the handling of dusty material and the energy involved in returning the fines to a sinter plant.

The EZINEX® process is based on ammonia/ammonium chloride leaching followed by cementation and electrolysis. It was developed for the direct treatment of EAF dusts and one plant is operational. It may be used for richer secondary zinc feed [117, Krüger, J. 1999].

Processes are being developed to optimise the recycling of batteries by treating only certain battery parts in a closed recycling loop. The known processes are all still in the development phase.

The treatment of slags arising from pyrometallurgical zinc and lead production in a submerged arc furnace for recovery of zinc and lead and production of a useable and environmentally friendly slag is being investigated.

The recirculation of electric arc furnace dust within the fabric filter agglomerates the dust. This results in an increase in the zinc content of the dust collected in the bag filters.

7 PROCESSES TO PRODUCE PRECIOUS METALS

7.1 Applied processes and techniques

Precious metals can be conveniently divided into three groups; silver, gold and platinum group metals (the latter, PGMs, comprises platinum, palladium, rhodium, ruthenium, iridium and osmium). The most significant sources are precious metal ores, by-products obtained from the processing of other non-ferrous metals (in particular anode slimes from copper production, and leach residues and crude metal from zinc and lead production) and recycled material. Many raw materials are subject to the Hazardous Waste Directive and this has an impact on the transport, handling and notification systems.

Production processes are common for primary and secondary raw materials and they are therefore described together. For a given refinery, the scale of operation reflects the relative quantities of each metal present. Typically there is much more silver and gold than PGMs.

A variety of processes have been developed which exploit the chemical properties of these metals. Although they are relatively inert, their reactivity varies and the various oxidation states of the metal in their compounds allows a variety of separation techniques to be used [5, B R Lerwill et al. 1993], [18, HMIP (UK) 1994]. For example, the tetroxides of ruthenium and osmium are volatile and can be separated easily by distillation. Many of the processes use very reactive reagents or produce toxic products, and these factors are taken into account by using containment, fail-safe systems and sealed drainage areas to minimise losses. This is further driven by the high value of the metals.

Many of the processes are commercially confidential and only outline descriptions are available. Production processes are usually carried out in various combinations to recover the precious metals that are present in a particular feedstock. The other feature of the industry is that, generally, the precious metals are recovered on a toll basis, which can be independent of the metal value. Much of the processing is therefore designed to accurately sample and assay the material as well as recover it. Sampling is carried out after the material has been processed physically or from side-streams during normal processing. There are over 200 types of raw materials available to the industry and they are normally characterised into five homogenisation categories as shown in Table 7.1.

Table 7.1: Homogenisation categories of raw materials

Homogenisation category	Type of raw material	Comment
Original	Catalysts, prepared sweeps, solutions	Direct to process
Sweeps	Mineral + metal, non-fusible carbon catalysts	Incineration, roasting and pre-enrichment
Scrap	Fusible material	
Material to be shredded	Photographic material, electronic scrap	
Material for dissolution	Material that is dissolved in acid, CN, NaOH, etc.	
<i>Source: [18, HMIP (UK) 1994].</i>		

The raw material characterisation is based on the most suitable processing flowsheet entrance point (see Figure 7.1), and is largely independent of the precious metals that the material contains. The raw materials are usually sampled according to this characterisation and it is reported that most companies use this scheme. The samples are subject to treatment to dissolve the precious metal content or produce a form capable of analysis. Sometimes this may also involve all or part of the actual recovery process and so abatement systems are used during the sampling process.

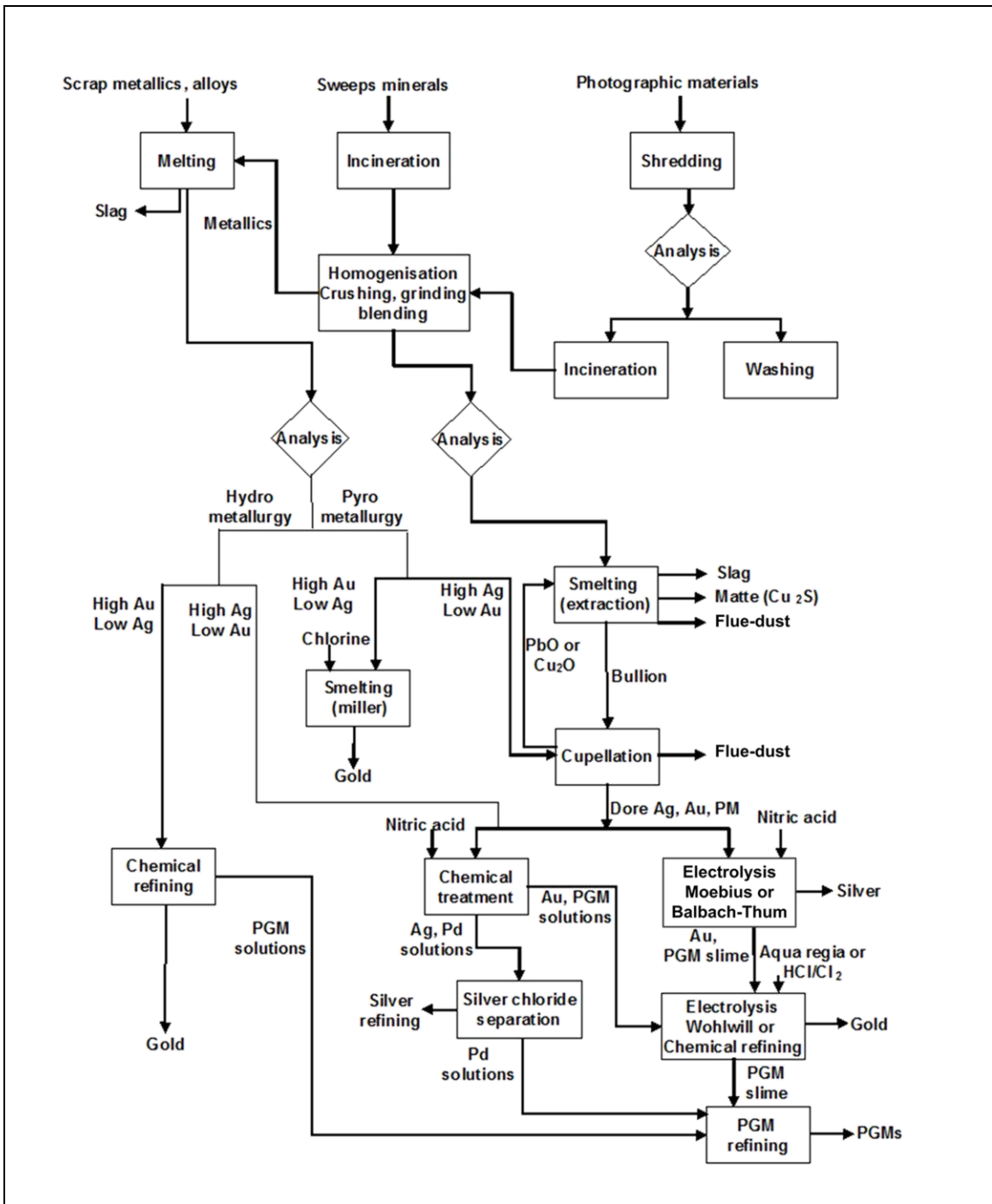

Figure 7.1: Example of a general flowsheet for precious metal recovery

There is also a need to process these materials rapidly and this is reflected in the intentional overcapacity of production in this sector. Extensive sampling and analysis also allow the optimum choice of process combinations to be made.

Anode slimes from electrolytic copper refining are a significant source of precious metals and they are treated to remove and recover the precious metals together with other metals such as selenium and tellurium. The process details depend on the proportion of metals present. Pyrometallurgical or hydrometallurgical routes are used, and solvent extraction stages are also included in some cases. Figure 7.2 gives a general example of a flowsheet for anode slime treatment.

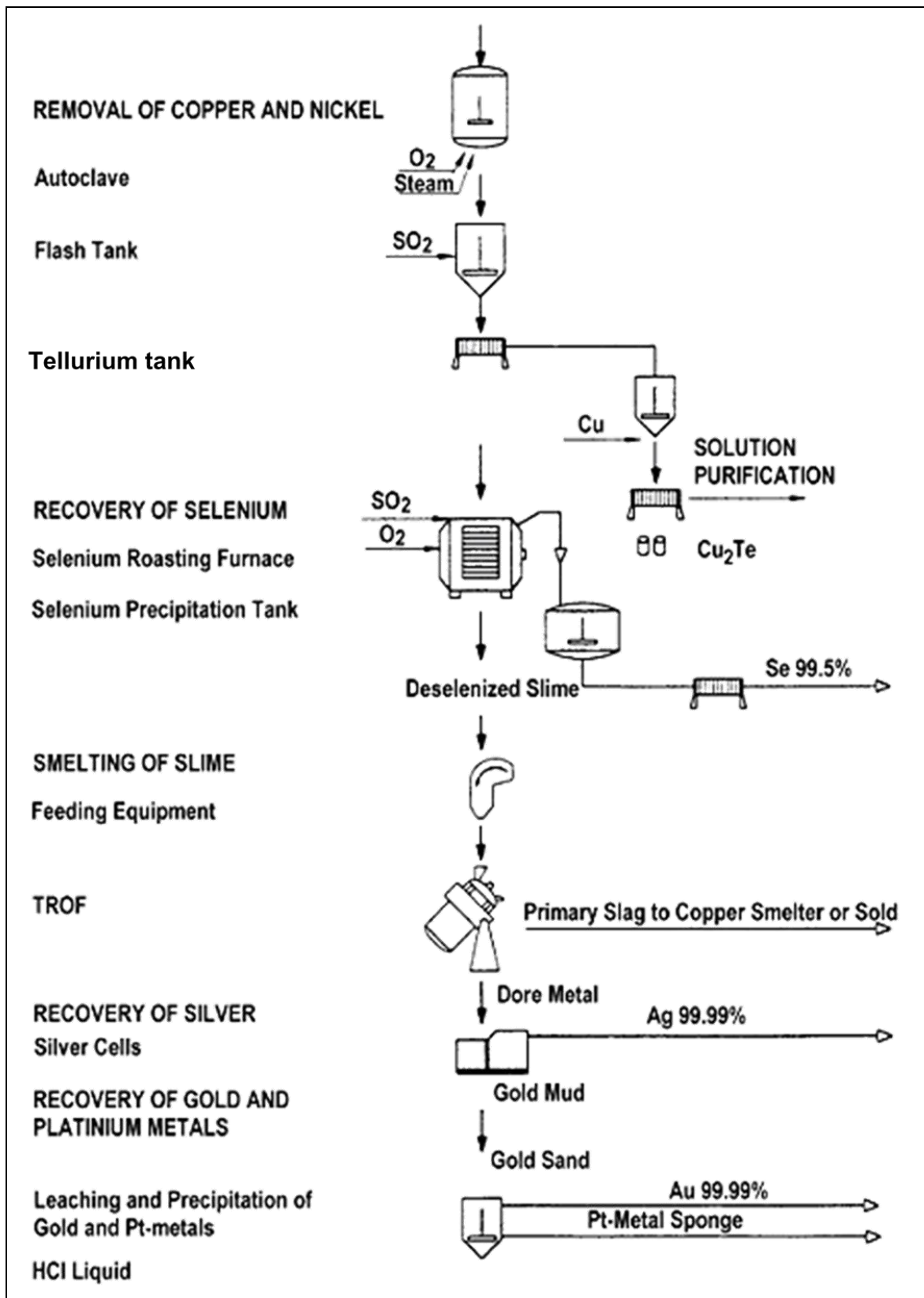

Figure 7.2: Example flowsheet for anode slime treatment

7.1.1 Silver

In 2012, global scrap supply increased by 12 % to a new all-time high of 7985 tonnes. The structural decline in the supply of photographic scrap, which had accounted for a dominant share of total scrap until the late 2000s, was offset by a material rise in industrial recycling and price-related scrapping of jewellery and silverware. Electronic scrap flows benefited not only from tighter environmental legislation, but also from the acute rise in silver prices. However, it was the recovery of silver from old silverware and jewellery that accounted for the bulk of the 12 % rise in world scrap supply. There was also a rise in coin scrap. Fundamental to the overall total was a jump in industrialised market collection (mainly in the United States and Europe), which comfortably exceeded the rise in recycling in the price-sensitive developing world markets (such as India) [426, GFMS 2012].

Mine production remains by far the largest component of silver supply, normally accounting for around two thirds of the total (in 2011 it was higher at 73 %). Much of the mine supply will contain silver as an impurity in other metals (typically lead), from which it is removed. However, mine production is not the sole source, the others being scrap, disinvestment, government sales and producer hedging. Scrap, or more accurately 'old scrap', is the silver that returns to the market when recovered from manufactured goods. This could include old jewellery, photographic chemicals, even discarded computers. Old scrap normally makes up around a fifth of the total supply [426, GFMS 2012]

7.1.1.1 Photographic materials

Photographic film, papers and sludges are incinerated on a batch basis in single hearth furnaces, or on a continuous basis in rotary kilns, to produce a silver-rich ash. Smaller recyclers use box furnaces. The calorific value of the feed is such that fuel is only required during start-up. An afterburner, located in a separate chamber, is used to combust the partially burnt products in the waste gas, as well as filter and caustic scrubber systems. The ash is recovered and treated with other silver-bearing material, the gases are filtered and the dust that is collected is treated to recover silver.

A chemical stripping process in which the silver salts are leached from the emulsion layer is also used. This process treats waste photographic film with a thiosulphate solution that may also contain enzymes. The silver is recovered from the leach liquor by electrowinning and the depleted electrolyte is recycled to the leaching stage. The plastic backing of the photographic film can in theory be recovered but the feed material usually includes some paper such as envelopes and this can inhibit recovery and result in a waste stream [5, B R Lerwill et al. 1993] Silver is also recovered from waste solutions from the photographic industry and others by chemical precipitation as sulphide to form a powder, which is dried, melted and refined.

7.1.1.2 Ashes, sweeps, etc.

Ashes, sweeps, printed circuit boards, agglomerated fines, sludges and other materials that contain copper and precious metals are blended and smelted in Ausmelt/ISASMELT, electric, blast, rotary and reverberatory furnaces or top-blown rotary converters (TBRCs). Lead or copper is used as a collector for the silver and other precious metals; electric power or a fuel such as coke, gas or oil is used to generate a reducing atmosphere. In some cases, select plastic waste can be used as a fuel or as a reducing agent and in these cases appropriate afterburning is used to prevent the emission of organic compounds such as VOCs and PCDD/F. Fluxes are added to collect the non-metallic components of the feed materials, which are removed as a slag. Periodically the furnace is run with a slag charge to recover any precious metals in the slag before it is granulated or cast prior to disposal, treatment for depletion or use.

The silver and other precious metals produced in the smelting furnace are collected into molten lead or copper. The lead alloy is transferred to a cupellation furnace where the lead is oxidised to litharge (lead oxide) using air or oxygen. The copper alloy is treated in a similar manner to that used to produce copper oxide. Some refiners do not oxidise, but process the lead alloy directly to recover precious metals.

These precious metal-bearing materials may also be treated in base metal smelters. The metals are then recovered from the lead, copper or nickel processes.

7.1.1.3 Recovery from base metal production

The electrolytic refining of copper anodes produces slimes, the composition of which depends on the feed materials and processes used in the copper smelter. Anode slimes generally contain significant quantities of silver, gold and PGMs and they are sold for their precious metals value [46, Guindy, M 1996], [47, Järvinen, O 1995], [48, Järvinen, O 1994], [49, Hyvärinen, O. et al. 1989] or recovered at the site of the smelter [90, Traulsen, H. 1998]

Treatment processes vary according to the composition of the slimes. An example is shown above in Figure 7.2 which includes the recovery of selenium. The stages can include the removal of copper and nickel (and a major proportion of the tellurium) by acid leaching (atmospheric or under pressure using O₂), or by roasting to also remove selenium, unless it has already been removed by volatilisation during smelting. In some cases, lead residues are produced which are recovered in dedicated lead processes.

Doré (silver or gold) is metal that has been concentrated to a form that contains 25–99.55 % silver and 0–99 % gold with specified impurities. Doré metal is produced by melting and refining anode slimes from copper electrorefining as well as from precious-metal-enriched alloys from lead refining, leach residues and crude metal from zinc and lead production, returns and sweeps from silver production (such as dust from bag filters, slimes from wet dedusting systems, silver cement obtained from spent silver electrolyte, slags, crushed refractory) and other silver-rich materials and/or silver scrap. Refining is carried out with coke, silica, lime and sodium carbonate fluxes to maximise separation from other metals whilst controlling the formation of volatile metal compounds. Different combinations of batch-wise processes can be used depending on the composition of the raw materials and the local conditions. In general, the following process steps are involved:

- drying of decoppered slime in indirectly heated steam dryers;
- melting and converting in a furnace (e.g. Kaldo, top-blown rotary or tilting rotary oxy-fuel (TROF) furnace) to remove impurities and retain crude PM alloy;
- volatilisation and recovery of selenium from the furnace off-gas during melting or prior to it, via separate roasting in an electrically heated furnace;
- final refining of the PM alloy/raw silver or gold in the same furnace or cupellation of precious-metal-enriched alloys from lead and copper lines in a separate furnace (e.g. TBRC, TROF, BBOC);
- casting of Doré anodes, ingots or bars.

Hydrometallurgical and solvent extraction stages are also used for the recovery of precious metals from anode slimes, for example the Kennecott and Phelps Dodge processes. In the hydrometallurgical production of zinc, the precious metals, if present in the concentrate, are enriched in the lead-silver leach residue, which can be processed further in a lead smelter. During lead smelting and refining, the precious metals are concentrated in a Pb-Zn-Ag alloy (see Figure 7.3).

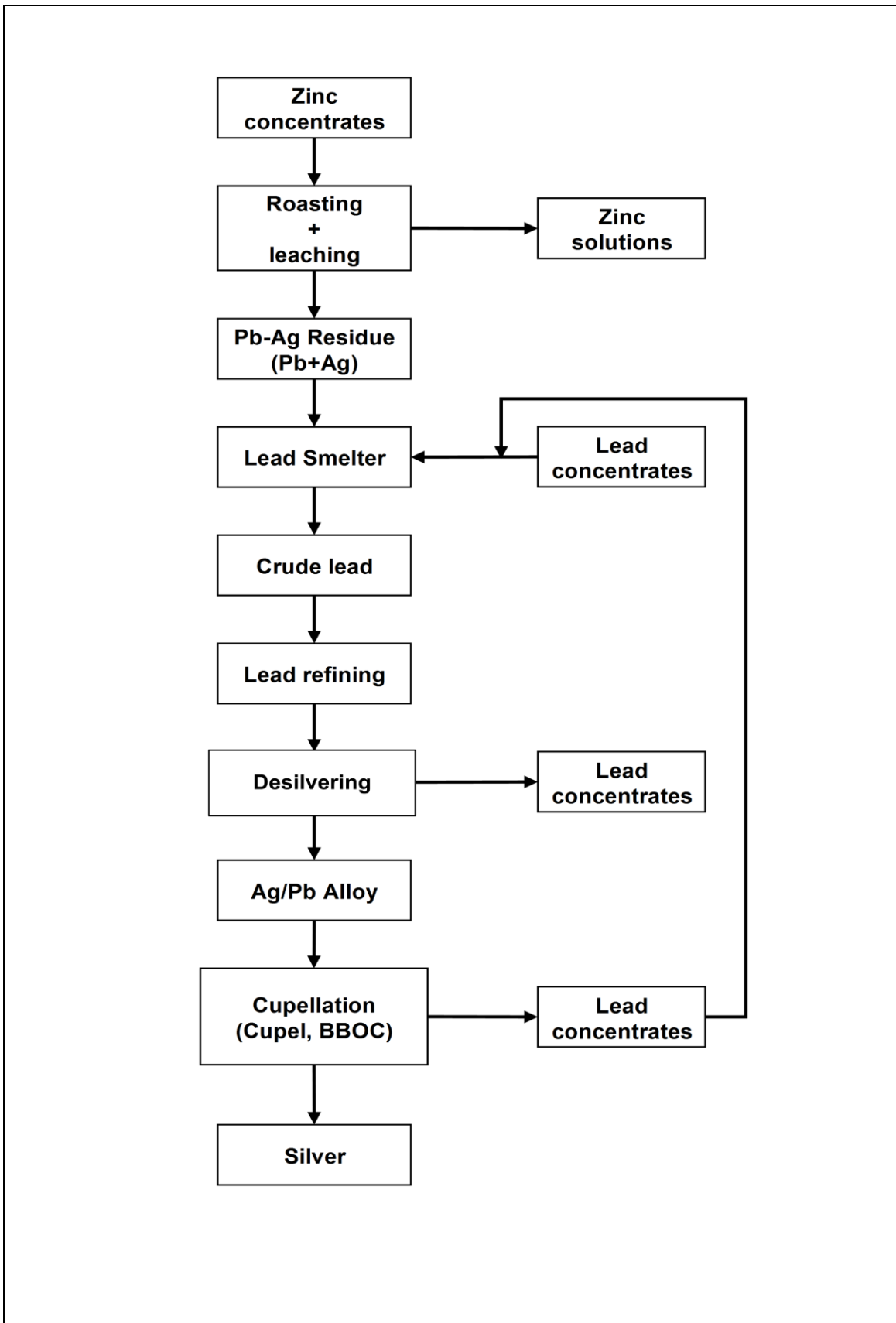

Figure 7.3: Recovery of silver from zinc and lead production

Further treatment can include the removal of the bulk of the lead and zinc by liquation and vacuum distillation and finally cupellation in a reverberatory furnace, TBRC, TROF, cupel or a bottom-blown oxygen cupel (BBOC). Lead is oxidised to litharge using air and oxygen. Some

installations that operate copper and lead refineries combine the precious-metal-enriched phases from the lead and copper lines during the cupellation stage.

In the refining of nickel, the precious metals are recovered from the copper by-product. In the refining of zinc in a zinc-lead shaft furnace, the precious metals may be recovered from the lead product. Precious metal recovery processes vary according to the amount of desired metals and other associated metals, such as selenium, present.

7.1.1.4 Refining

The anodes are refined in Moebius or Balbach-Thum electrolytic cells using titanium or stainless steel cathodes in an acidified silver nitrate electrolyte. A direct current applied between the electrodes causes silver ions dissolved from the anode to migrate and deposit as silver crystals on the cathodes. The crystals are continuously scraped off the cathodes, removed from the cells, filtered and washed. The slimes from the electrolytic cells are treated for their gold and PGM content.

The silver crystals may be melted in a crucible furnace and batch cast into market ingots or grains for rolling down. They can be continuously cast into market bars for rolling down to sheet and strip. Silver is also cast into billets for extrusion into rods for subsequent drawing into wire.

Silver produced by smelting and high-grade silver residues from manufacturing processes can be further refined by dissolution in nitric acid. The resulting solution is purified either by recrystallisation as silver nitrate suitable for use in the photographic industry or by electrolysis to fine silver for melting and casting into bullion bars.

7.1.2 Gold

The principal sources of gold are mining operations, industrial processes, jewellery, sweeps, and dental scrap. Gold is recovered along with silver from the anode slimes from copper electrorefining and from other materials using the processes described above. Gold is present in the anode slimes from the silver electrolysis stage and is recovered by leaching the slimes with hot hydrochloric acid and chlorine gas before it is precipitated from the resultant solution [282, KGHM 2008]. Scrap materials may contain significant proportions of zinc, copper and tin.

7.1.2.1 The Miller process

The Miller process can be used to pretreat the material. In this process, the feed materials are melted in an indirectly heated crucible or electric induction furnace while chlorine gas is injected into the melt. At the operating temperature of about 1000 °C, gold is the only metal present that does not react to form a stable molten or volatile chloride. Molten silver chloride rises to the surface of the melt. A borax flux is used to assist the collection and skimming of the metal chlorides. Zinc in the feed is converted to zinc chloride which, together with volatile metal chlorides, is exhausted to a gas scrubbing system [5, B R Lerwill et al. 1993] [102, Hasenpusch, W. 1998] [5, B R Lerwill et al. 1993], [102, Hasenpusch, W. 1998].

The Miller process is operated to produce either 98 % gold, which is cast into anodes for electrorefining, or 99.5 % gold, which is cast into bullion bars.

7.1.2.2 Electrorefining

Gold anodes are refined in Wohlwill cells that contain gold foil or titanium cathodes. The electrolyte used is an acidic gold chloride solution maintained at about 70 °C. A DC electric current applied between the electrodes causes gold ions dissolved from the anodes to migrate and deposit on the cathodes, yielding a product that contains 99.99 % gold. Chlorine is evolved at the anode and is collected in an integrated enclosure.

7.1.2.3 Other processes for gold recovery

Gold can also be recovered and refined by dissolving the feed materials in aqua regia or in hydrochloric acid/chlorine. This is followed by the precipitation of high-purity gold suitable for melting and casting. When the feed material contains significant quantities of metallic impurities, a solvent extraction step may be introduced before the gold precipitation stage. Solvent extraction processes and precipitation are also used to recover gold from liquors arising during the production of platinum.

Gold is also removed from solid and liquid cyanide solutions such as plating baths. Solutions of sodium or potassium cyanide can be used to remove gold from surface-coated material such as electronic contacts or plated materials. Gold is recovered from the cyanide solutions by electrolysis. Cyanides react with acids to form hydrogen cyanide (HCN) and therefore careful segregation of these materials is practised. Oxidising agents such as hydrogen peroxide or sodium hypochlorite, as well as high-temperature hydrolysis, are used to destroy cyanides.

7.1.3 Platinum group metals (PGMs)

PGMs comprise platinum, palladium, rhodium, ruthenium, iridium and osmium. The principal raw materials are concentrates produced from ores, mattes and slimes from nickel and copper operations. Secondary materials such as spent chemicals and automotive exhaust catalysts and electronic and electrical component scrap are also significant sources. PGMs can be present in the anode slimes described above and are separated from the gold and silver by a variety of hydrometallurgical processes. Low-grade feedstock may be crushed and blended while metallic feed materials are generally melted to provide a homogeneous product for sampling.

The main stages in the recovery of PGMs are [102, Hasenpusch, W. 1998], [5, B R Lerwill et al. 1993], [18, HMIP (UK) 1994]:

- pretreatment of the feedstock, sampling and assay;
- concentration and separation of PGMs by pyrometallurgical and hydrometallurgical techniques, such as chemical precipitation, chemical dissolution, liquid-liquid extraction, distillation of tetroxides, ion exchange and electrolytic processes;
- pyrolysis or reduction of metallic chloride compounds to pure metal sponges.

Specific processes have been developed for carbon-based catalysts, using incineration prior to the dissolution stage. Powder-based catalysts and sludges are treated in batches, often in box furnaces. Direct flame heating is applied to dry and then ignite the catalyst, which is allowed to burn naturally. The air ingress to the furnace is controlled to modify the combustion conditions and an afterburner is used.

Reforming or hydrogenation catalysts can be treated by dissolution of the ceramic base in sodium hydroxide or sulphuric acid. Prior to leaching, the excess carbon and hydrocarbons are burnt off. PGMs from automotive exhaust catalysts can be collected separately in copper or nickel in plasma, electric or converter furnaces [102, Hasenpusch, W. 1998]. Small operators use open trays to burn off catalysts by self-ignition or roasting. These processes can be dangerous and fume collection and afterburning can be used to treat the fume and gases.

Organic-based homogenous spent catalysts, e.g. from the chemical or pharmaceutical industries, can be treated by distillation and precipitation. The gaseous emissions are treated in an afterburner.

PGM refining is complex and individual process stages may have to be repeated to achieve the required purity. The number and order of the stages also depend on the contaminants to be removed and the specific mix of PGMs to be separated from any one batch of feedstock. The processing of secondary materials such as spent chemicals and automotive exhaust catalysts, electrical and electronic scrap in base metal smelters or specific equipment finally produces PGM-rich residues or precipitates.

7.2 Current emission and consumption levels

Precious metal (PM) refineries are complex networks of main and subsidiary processes. The raw materials used vary greatly in quality and quantity and therefore the equipment used has a variety of capacities and uses. Multi-purpose reactors and furnaces are used extensively and processing steps are often repeated. It is therefore not possible to identify single process steps and their contribution to emissions and consumption.

Some general principles apply to the emissions and consumption of this sector.

- To isolate precious metals, it is necessary to treat on average ten times more material than they amount to. The concentrations vary from < 1 % to nearly pure metal.
- High-energy techniques are used, e.g. electric furnaces. Energy is recovered if appropriate.
- Residues that contain base metals are sold for recovery.
- Many chemical treatments involve the use of cyanide, chlorine, hydrochloric acid and nitric acid. These reagents are reused within the processes but eventually require oxidation or neutralisation with caustic soda and lime. Sludges from waste water treatment are closely monitored for metals, which are recovered if possible.
- A variety of organic solvents are used for liquid-liquid extraction.
- A variety of oxidising and reducing agents are used.
- Acid gases such as chlorine or nitrogen oxides are recovered for reuse.
- Gas volumes vary greatly between cycles. The small scale of the processes usually allows for good containment. Local exhaust ventilation is used.

7.2.1 Material loops in the precious metal recycling industry

One of the characteristics of the PM industry is the need to keep solution volumes small to diminish the losses of precious metals or their compounds. Consequently, there are several closed cycles in operation to reclaim materials and these are shown below.

7.2.1.1 The non-metallic cycles

Hydrochloric acid and nitric acid are mainly used for the dissolution of metals. Sulphuric acid is used to a lesser extent as part of scrubber solutions for ammonia absorption and as an electrolyte in silver powder baths. Other materials are used as reagents or are present in the feed materials. [102, Hasenpusch, W. 1998].

- **The hydrochloric acid loop:** For processes involving dissolution, hydrochloric acid (HCl) is used in combination with excess chlorine. By using evaporation and collection in water, an azeotropic acid (in concentrations of about 20 wt-%) is obtained. This is used in different parts of the refinery.
- **The nitric acid loop:** Silver and palladium are often dissolved in nitric acid (HNO₃). A significant quantity of nitrogen oxide off-gases (NO and NO₂) can be captured with oxygen or hydrogen peroxide in special scrubber cascades. The long residence time needed to oxidise small quantities of NO and the reduction of gas absorption by exothermic reactions can produce problems. Therefore cooling and combined scrubbers are necessary to reach the limit values and avoid brown fumes from the stack. The resulting nitric acid from the first scrubber usually has concentrations of about 45 wt-% and can be reused in several processes.
- **The chlorine loop:** Chlorine is used in wet processes to dissolve metals and in dry chlorination steps at elevated temperatures to refine them. In both cases, closed systems

are used, e.g. using U-tubes with water to produce hypochlorite solutions. Hypochlorite is also used as an oxidising agent in scrubber solutions for various refining processes.

- **The ammonium, sodium or potassium chloride loop:** Ammonia and ammonium, sodium or potassium chloride are used in the recovery of PGMs. The relatively low solubility of ammonium chloride (NH_4Cl) in evaporated solutions at room temperature makes it possible to reuse crystalline precipitates of this salt.
- **The alumina loop:** Heterogeneous catalysts based on alumina (Al_2O_3) are treated in PM refineries in large quantities, for example, the reforming catalysts from the oil refining industry. The catalysts are dissolved in caustic soda above $200\text{ }^\circ\text{C}$ under pressure and the resulting aluminate solution is sold after separation of the PM as a precipitation aid in water treatment. Alternatively it can be returned to the alumina industry via the Bayer process (dissolution of bauxite). Similar external cycles are possible with aluminium sulphate solutions, which result when the catalysts are dissolved in sulphuric acid.

7.2.1.2 The non-PM loops

PM refineries process a lot of materials that contain copper, lead, tin, tungsten, rhenium, cadmium, mercury and other special metals. For the separation of all these metals, special processes are established which produce concentrates for external non-PM metallurgical plants [102, Hasenpusch, W. 1998].

- **Copper:** The use of copper as the carrier material for precious metals is becoming more important and, as a consequence, copper oxides often remain after the smelting processes. In hydrometallurgical stages, copper can be precipitated by caustic soda (NaOH) and/or lime (CaO). Copper residues can be recovered in a copper refinery or converted to sulphate and electrowon if the volume justifies it.
- For removing traces of copper, especially in the presence of chelates like ammonia, precipitation with sulphides or mercaptan compounds (e.g. TMT 15, a 15 wt-% solution of trimercaptotriazine) is necessary.
- **Lead:** Lead cycles are known to have been used since the Middle Ages in the refining of silver. The process is still used in the sweep extraction. Liquid lead is a good solvent for PMs, especially in an excess of silver. The PM-enriched lead is oxidised in furnaces or converters by oxygen, producing an almost quantitative separation of lead and other non-PMs. The resulting oxides are reduced by carbon, e.g. in a blast furnace, and lead is produced and is reused in the process. Excess lead is sold to lead refineries. Some refiners do not oxidise the lead alloy but process it directly and recycle the lead from the leach solutions.
- **Tin:** Tin is separated as the metal in solution or as a hydroxide precipitate.
- **Tungsten and other metals:** For some metals from galvanic processes, the base metals such as nickel alloys, tungsten and molybdenum can be recycled by cyanide stripping.
- **Rhenium:** For rhenium, ionic exchangers are used. After purification and precipitation, an ammonium salt (NH_4ReO_4) is produced.
- **Cadmium:** The cadmium concentration of special alloys, e.g. solders and brazes, has decreased in recent years. Cadmium is enriched in the flue-dusts of special campaigns and sent to external metallurgical plants.
- **Mercury:** Mercury may form part of some special materials in small concentrations, e.g. dental amalgam, powders or slimes, residues from battery plants and special Polaroid films. For this kind of material, high-temperature distillation, perhaps combined with a low vacuum, is the first step of recovery. Average concentrations of the distilled scraps and sweeps are less than 0.1 wt-% of mercury concentration limits.

These loops and the separation of non-PM compounds contribute to the avoidance of contamination and the optimisation of profitability.

7.2.2 Environmental issues for precious metal production processes

Precious metal production processes are primarily a source of particulate and gaseous emissions to air and emissions to water. Generally, the information given in Sections 7.2.2.1 to 7.2.2.3 below describes the most relevant environmental issues for precious metals production.

7.2.2.1 Emissions to air

The sources of emissions are as follows:

- Incineration.
- Other pretreatment.
- Smelting and melting furnaces. Typical smelting and melting operations responsible for generating dust and fume are:
 - o smelting in a top-blown rotary converter (TBRC), plasma arc furnace or other furnace;
 - o smelting/granulating ingots and metallic scraps containing precious metals and ingots of other valuable metals in a crucible furnace including induction melting;
 - o smelting silver chloride and other potentially silver-dust-bearing metals in a furnace;
 - o melting and casting silver metal from a furnace.
- Leaching and purification.
- Solvent extraction.
- Electrolysis.
- Final recovery or transformation stage.

The main emissions to air from precious metal production are:

- sulphur dioxide (SO₂) and other acid gases (HCl);
- oxides of nitrogen (NO_x) and other nitrogen compounds;
- metals and their compounds;
- dust;
- chlorine;
- ammonia and ammonium chloride;
- VOCs and PCDD/F.

Odour may be present as a result of some of the compounds listed above. The relevance of potential emissions to air from the major sources in precious metals production is given in Table 7.2.

Table 7.2: Relevance of potential emissions to air from the major sources in precious metals production

Component	Incineration or smelting	Leaching and purification	Electrolysis	Solvent extraction	Distillation
SO ₂ and HCl	••	•	•	NR	NR
VOCs	•	•••	NR	•••	•••
PCDD/F	••	NR	NR	NR	NR
Chlorine	•	•••	••	NR	NR
Nitrogen oxides	••	••	NR	NR	NR
Dust and metals	••• ⁽¹⁾	•	•	•	•

⁽¹⁾ Diffuse or uncaptured emissions are also relevant for these sources.
 NB: ••• More significant – • Less significant.
 NR = Not relevant.
 Source: [374, COM 2001]

7.2.2.1.1 Dust and metals

Dust and metals can generally be emitted from any pyrometallurgical process such as incinerators, smelting, melting and cupellation furnaces, as diffuse or collected and abated emissions. Furnace sealing and secondary collection from launders is an important factor in preventing diffuse emissions. Some electric furnaces use hollow electrodes for material additions, to allow improved furnace sealing. Ash from incinerators is usually quenched and the maintenance of the water seal is an important factor in reducing diffuse emissions. Batch incinerators using open trays or boxes present dust and ash containment problems. Collected emissions are usually treated in ceramic or fabric filters, ESPs or wet scrubbers [161, Bobeth, A. 1999]

Dust can arise from handling operations such as:

- mixing of smelt materials and fluxes, etc. in powder mixers prior to smelting;
- fettling of PM and other metal-containing ingots to remove traces of slag prior to sampling or melting;
- crushing of slag, spent crucibles and refractory materials in a crusher;
- mixing/sampling/crushing/sieving of feed materials containing PM and other valuable metals in powder form;
- pulverising (crushing) and disposal of process intermediates from drying and calcining operations.

7.2.2.1.2 Sulphur dioxide

Sulphur dioxide is formed from the combustion of sulphur contained in the raw material or the fuel, or produced from acid digestion stages. Control of the feedstock can be used to minimise emissions; wet or semi-dry scrubbers are used when the concentrations justify it. Electrode mists and gases can be produced during electrowinning. Gases can be collected and reused and mists can be removed by demisters and returned to the process. Some installations operate on the site of a primary smelter and the off-gases are treated in the sulphuric acid plant [238, ECI 2012], [282, KGHM 2008]

7.2.2.1.3 Chlorine and HCl

These gases can be formed during a number of digestion, electrolytic and purification processes. Chlorine is used extensively in the Miller process and in the dissolution stages using hydrochloric acid and chlorine mixtures. Chlorine is recovered for reuse wherever possible, e.g.

using sealed electrolytic cells for gold and PGMs. Scrubbers are used to remove residual amounts of chlorine and HCl.

The presence of chlorine in waste water can lead to the formation of organic chlorine compounds if solvents, etc. are also present in the mixed waste water.

7.2.2.1.4 Nitrogen oxides

Nitrogen oxides are produced to a certain extent during combustion processes and in significant amounts during acid digestion using nitric acid. High concentrations of nitrogen oxides are treated in scrubbers so that nitric acid can be recovered; various oxidising agents are used to promote conversion and recovery as nitric acid.

Residual nitrogen oxides from furnace off-gases can be removed by catalytic means such as selective or non-selective catalytic reduction if very high NO_x concentrations occur continuously [161, Bobeth, A. 1999].

The choice of the abatement system essentially depends on the variation of the NO_x concentration.

7.2.2.1.5 VOCs and PCDD/F

VOCs can be emitted from solvent extraction processes. The small scale of the processes usually allows the sealing or enclosure of reactors and good collection and recovery using condensers. Collected solvents are reused [102, Hasenpusch, W. 1998].

If the hot gases produced during the smelting stages are not cooled rapidly, the organic carbon compounds that can be emitted might include PCDD/F, resulting from the poor combustion of oil and plastic in the feed material and from de novo synthesis. Scrap treatment to remove organic contamination can be practised, but usually afterburners are used to treat the gases produced followed by rapid cooling. When it is not possible to treat the gases from the furnaces in an afterburner, they can be oxidised by adding oxygen above the melting zone. It is also possible to identify organic contamination of secondary raw materials so that the most appropriate furnace and abatement combination can be used to prevent the emissions of smoke and fumes and the associated PCDD/F. Organic compounds, including PCDD/F, can be decomposed by catalytic oxidation, often in joint reactors.

7.2.2.1.6 Summary of emissions to air

Table 7.3 gives the specific emissions for three major pollutants and Table 7.4 shows the emission concentrations for three different processes in precious metal production.

Table 7.3: Specific emissions to air from a range of precious metal production processes

Parameter	Unit	Plant 1	Plant 2	Plant 3	Plant 4	Plant 5
Production	t/yr	2155	1200	2500	1110	102
Dust	kg/t	58	4.5	2	18	127
NO _x		154	68	7	NR	21
SO ₂		232	3.1	9	NR	NR
NB: NR = not reported Source: [374, COM 2001]						

Table 7.4: Concentrations of emissions to air from three different processes in precious metal production

Parameter	Unit	Incineration processes	Pyrometallurgical processes	Hydrometallurgical processes
Production range	t/yr	73–365	150–1200	20–600
Dust	mg/Nm ³	2–10	4–10	
Nitrogen oxides		50–150	~ 200	1–370
Sulphur dioxide		1–25	10–100	0.1–35
CO		10–50	80–100	
Chloride		2–5	< 30	0.4–5
Cl ₂			< 5	2–5
Fluoride		0.03–1.5	2–4	
TVOC		2–5	2–20	
PCDD/F	ng I-TEQ/Nm ³	< 0.1	< 0.1	
HCN	mg/Nm ³			0.01–2
NH ₃				0.2–4

Source: [161, Bobeth, A. 1999]

Two plants have reported data for captured emissions to air for different process steps as summarised in Table 7.5.

Table 7.5: Captured emissions to air from two PM plants for different process steps

Pollutant	Unit	Plant 1						Plant 2		
		Without sulphuric acid plant	With sulphuric acid plant	Furnace hall (furnace in operation)	Furnace hall (awaiting charge)	Refinery	Slag crushing	Ag, Au process step	Pt scrubber	PtRh, Pd scrubber
Dust	mg/Nm ³	2.9	NR	0.5	0.3	1.1	1.1	0.097	NA	NA
NO _x	mg/Nm ³	520	230	NA	3	3	NA	17.1	NA	92
SO ₂	mg/Nm ³	9400	280	NA	6	2	NA	NA	NA	NA
H ₂ SO ₄	mg/Nm ³	NA	70	NA	NA	NA	NA	NA	NA	NA
CO	mg/Nm ³	830	NA	NA	21	1	NA	NA	NA	NA
Cl ₂	mg/Nm ³	NA	NR	NA	NA	NA	NA	N	NA	0.134
HCl	mg/Nm ³	NA	NR	NA	NA	NA	NA	NA	3.12	0.926
PCDD/F	ng I-TEQ/Nm ³	NA	NR	NA	NA	NA	NA	NA	NA	0.02
Cu	mg/Nm ³	0.24	NR	0.0005	NA	NA	0.022	NA	NA	NA
Pb	mg/Nm ³	0.2	NR	0.029	NA	NA	0.43	NA	NA	NA
As	mg/Nm ³	0.011	NR	0.0005	NA	NA	0.003	NA	NA	NA
Cd	mg/Nm ³	0.001	NR	0.00001	NA	NA	0.0002	NA	NA	NA

NB: Daily averages.
NA = Not available. NR = Not relevant.
Source: [282, KGHM 2008] [403, EPMF 2008]

7.2.2.2 Emissions to water

On sites handling a range of metals, common facilities are frequently employed to manage emissions to water. The techniques referred to below may therefore not relate solely to precious metals.

Pyrometallurgical and hydrometallurgical processes use significant quantities of cooling water. Liquors from leaching cycles are normally recirculated in sealed systems. The sources of potential emissions to water from precious metals production are shown in Table 7.6 below. Suspended solids, metal compounds and oils can be emitted to water from these sources.

All waste water is treated to remove dissolved metals and solids. Techniques used include precipitation of metal ions as hydroxides or sulphides, or a two-stage precipitation. Ion exchange is suitable for low concentrations and amounts of metal ions. In a number of installations, cooling water and treated waste water, including rainwater, are reused or recycled within the processes.

Special techniques have been developed for precious metal processes to detoxify nitrite by a reduction process, and cyanide by hydrolysis in the waste water [161, Bobeth, A. 1999].

Table 7.6: Sources of potential emissions to water from precious metals production

Emission source	Suspended solids	Metal compounds	Oil
Surface drainage	•••	••	•••
Cooling water for direct cooling	•••	•••	•
Cooling water for indirect cooling	•	•	NR
Quenching water	•••	••	NR
Leaching (if not closed circuit)	•••	•••	•
Electrowinning (if not closed circuit)	NR	•••	NR
Scrubbing systems	•••	•••	NR

NB: ••• More significant – • Less significant.
NR = Not relevant.
Source: [374, COM 2001]

Emissions to water from seven plants are given in Table 7.7 and Table 7.8.

Table 7.7: Emissions to water from five large plants

Plant	Production (t/yr)	Effluent (m ³ /h)	Main components (mg/l)					
			Ag	Pb	Hg	Cu	Ni	COD
1	2155	10	0.1	0.5	0.05	0.3	0.5	400
2	1200	2	NR	< 1	< 0.05	< 2	< 5	NR
3	2500	100	0.02	< 0.05	< 0.05	< 0.3	< 0.02	250
4	1110	NR	NR	3.9 kg/yr	0.05 kg/yr	194 kg/yr	24 kg/yr	NR
5	102	NR	NR	1260 kg/yr	NR	2750 kg/yr	1640 kg/yr	NR

NB: NR = not reported
Source: [374, COM 2001]

Table 7.8: Emissions to water from two PM plants

	Unit	Plant 1	Plant 2	
Water consumption	m ³ /yr	111 829	111 829	
Water discharge (including rainwater, cooling water, process water)	m ³ /yr	61 093	61 093	
Component emitted to water				
As	kg/yr	1.73	9.5	
Pb		0.25	3.6	
Hg		0.04	0.01	
Zn		0.80	10.7	
Cd		0.002	0.1	
Cu		3.88	7.9	
Ni		7.03	6.1	
Cr		0.044	0.7	
Fe			21.3	
Se			31.7	
Ag			9.5	
Se			31.7	
Cyanide			126.22	
COD			37 850	11 500
Chlorides (total as Cl)			408 066	
Nitrogen (total as N)			3240	
Suspended solids		4.313		
<i>Source: [403, EPME 2008]</i>				

Other potential emissions to water may include ammonium, chloride and cyanide ions depending on the individual process stages. No data have been submitted to quantify these components.

7.2.2.3 Process residues

The production of metals is related to the generation of several by-products, residues and wastes, which are also listed in the European Waste Catalogue. Most process residues are recycled within the process or sent to other specialists to recover any precious metals. Residues that contain other metals, e.g. copper, are sold to other producers for recovery. The final residues from aqueous waste liquors generally comprise hydroxide filter cakes. Some typical examples are given in Table 7.9.

Table 7.9: Example of filter cake waste quantities

Annual waste for disposal (tonnes)	Waste characterisation
1000	Iron hydroxide, 60 % water, (Cat. 1 Industrial Waste)
1000	Effluent filter cake
350	Effluent filter cake
<i>Source: [102, Hasenpusch, W. 1998]</i>	

7.3 Techniques to consider in the determination of BAT

The sections of this document entitled 'Techniques to consider in the determination of BAT' set out techniques generally considered to have potential for achieving a high level of environmental protection in the activities within the scope of the document. The background to the way the techniques are described is given in Section 2.12 and Table 2.10.

This section presents a number of techniques for the prevention or reduction of emissions and residues as well as techniques for reducing the overall energy consumption. They are all commercially available. Examples are given in order to demonstrate techniques which illustrate a good environmental performance. The techniques that are given as examples are based on information provided by the industry, European Member States and the evaluation of the European IPPC Bureau. The general techniques described in Chapter 2 on common processes apply to a great extent to the processes in this sector and influence the manner in which the main and associated processes are controlled and operated.

General techniques applied to reduce diffuse emissions from the reception, storage and handling of primary and secondary raw materials are considered in Chapter 2 (see Section 2.12.4.1) and in the Emissions from Storage BREF [290, COM 2006].

7.3.1 Techniques to prevent and reduce dust emissions from PM material pretreatment and handling operations (e.g. crushing, sieving and mixing)

Description

The techniques to consider are:

- connecting pretreatment and handling operations for dusty materials to dust collectors or extractors via hoods and a ductwork system (see Section 2.12.4);
- filtering collected or extracted dust in dedicated stand-alone or general plant units equipped with a bag filter (see Section 2.12.5.1.4) or cartridge filter;
- electrically interlocking pretreatment and handling equipment (e.g. mixers, crushers) with a dust collector or extractor.

In some sites, depending on their size and overall organisation (individual or annexed to other metal refining operations for instance), the recovery and treatment of dust generated from pretreatment and handling operations are carried out in a such a manner that dust (and fumes) generated by smelting and other dust-generating operations is captured, treated and controlled in a centralised manner. This explains the similarities between techniques described in Sections 7.3.1, 7.3.2, 7.3.3 and 7.3.8.

Technical description

Enclosed buildings can have appropriate extraction devices (e.g. building dedusting systems) or extractors at the transfer and tipping points, or equivalent measures (i.e. misting of material). Dust suppression systems can be applied, such as water sprays or fog systems. The mixing of dusty materials can be carried out in an enclosed building or enclosed bins/mixers.

Bulk powder mixing, fettling and crushing operations are connected via hoods and a ductwork system to a bag filter or an absolute filter. For stand-alone units, fans extract the dust and fume away from the equipment and through the dust collector, before the filtered air is released to atmosphere via a stack. Typically a dust collector in a small or medium-sized refining site (e.g. a site refining PGM, which is refined in significantly smaller volumes than silver for instance), where land is at a premium, will contain cartridge filter elements. Alternatively, some sites with higher space availability use dust collector units which employ bag filter systems. Where cartridge or bag filters are employed, reverse intermittent jet air pulsing removes the dust from

the units, and it falls into a hopper and collection system. All of the mixing equipment, fettling booths and crushers served are normally electrically interlocked with the dust collector, so that no equipment can be operated unless the dust collector and filtering system are in operation. Where bag filters are used, the collected dust is fed as a raw material to the most suitable metal refining operation, depending on its composition.

For stand-alone dust collector units or general extractor plants, the stacks may be routinely fitted with particle-impact dust-measuring probes (or similar equipment) and instruments which are connected to a data-logging computer and relayed to a local operating area and/or a central control room. Besides giving on-line emissions data for the stacks, this equipment can provide a sophisticated diagnostic record of the status of individual rows of filter elements in the dust collector or extract unit. Probes are set to raise the alarm at a preset figure (typically 5–10 mg/m³ dust) in order to alert operating or control room personnel to the potential failure of a filter element and to shut down dust/fume-generating operations.

Achieved environmental benefits

- Reduction of dust emissions.
- Reduction of the generation of solid waste for disposal. The recovered flue-dust and filters from the dust collector are recycled within the refinery or by a third-party refiner for the recovery of PM and other valuable metals either by direct smelting or, after pretreatment, by pelletising or hydrometallurgical upgrading (no solid waste results from handling and pretreatment operations).

Environmental performance and operational data

Plant 221 is predominantly involved in the refining of PGMs. This involves upgrading low-grade feeds by smelting and dissolving high-grade feeds, and sequentially extracting the PGMs by solvent extraction and ion exchange.

Dust collectors at the refinery contain cartridge filter elements which have a > 99.99 % capture efficiency for particles of 0.5 microns. The exhausted cartridge filters are incinerated off site by a contractor. The PM-containing ash is returned to the refinery for recycling. Typical emissions from a small to medium-sized unit containing eighteen filters would be as show in Table 7.10.

Table 7.10: Dust emissions from PM Plant 221

	Abatement technique	Values obtained	Dust (mg/m ³)	Method to obtain data	Type of average
Plant 221	Cartridge filter	Average	1.12	Continuous monitoring	Monthly
		95th percentile	3.5		
		Maximum	4.38		
<i>Source:</i> [378, Industrial NGOs 2012]					

In the Kaldo furnace of Plant 117, where Doré metal is produced, two types of slag are formed. The slag from the first stage is crushed and transferred to the lead plant on site. The slag from the second stage, known as converter slag, is crushed and returned to the Kaldo furnace. Both types of slag are crushed in two stages. The preliminary crushing operation takes place in the main hall. The crushing area is equipped with a local hood connected to the central ventilation system of the plant. The air, following treatment in a bag filter system, is discharged to the atmosphere through a stack (these emissions are reported in Section 7.3.3).

Next, the preliminary crushed slag is transferred to the slag crushing station, located in a separate building. The slag crushing station is equipped with its own ventilation system and, after treatment in the bag filter, the air is discharged to the atmosphere through a stack (see Table 7.11).

Table 7.11: Dust emissions from the slag crushing station in PM Plant 117

Plant 117 (slag crushing station)	Abatement technique	Values obtained	Dust (mg/m ³)	Method to obtain data	Type of average
	Bag filter	Minimum	0.4	Periodic monitoring (4 times per year)	Over the sampling period
		Average	1.3		
		Maximum	2.6		

Source: [378, Industrial NGOs 2012]

After crushing, the slag is transferred in containers via a forklift truck to a lead plant or the Kaldo furnace.

In Plant 121, all the materials for precious metal refining are stored in an enclosed building. Dusty materials are stored in closed vessels / big bags and transferred via closed bins fitted with an exhaust system and via closed conveyors. Non-dusty or large materials are handled by mechanical loaders or cranes in enclosed buildings on an impermeable floor. Exhaust gases are treated in bag filters (emissions for this plant are reported in Section 7.3.3, as gases from pretreatment operations are treated together with gases from Doré metal production).

Cross-media effects

Increase in energy use, in order to operate extraction and dedusting systems. Roof extraction systems are a particularly energy-intensive technique.

Technical considerations relevant to applicability

The choice of pretreatment and subsequent abatement techniques depends on the type of furnace and smelting process, as well as on the type and particle size of the raw materials used as feedstock.

Building ventilation may be installed depending on different factors, such as the size of the particles, the size and use of the storage hall and the individual emissions situation.

A centralised cartridge filter dust collection system would be applicable for new installations handling powder or dusty materials, but a major upgrade would be required for it to be implemented in existing installations.

A bag-filter-based system is easier to maintain, less likely to blind due to the pleating in cartridges, and the filtration media tend to last longer. Cartridge filter systems are generally easier to automate and are preferred for sites where land is at a premium, as they take up far less space.

Economics

A small to medium-sized cartridge filter dust collector, e.g. comprising 18 cartridge filters and with a fan rating of 7500 m³/hour, would have a capital and installation cost in the region of EUR 0.25 million at current prices [404, EPMF 2012].

Driving force for implementation

- Reduction of emissions.
- Environmental regulation requirements.
- To minimise the loss of valuable (precious) metals and to save and recover raw materials containing PM and other valuable metals.

Example plants

Plants 112, 113, 117, 121, 205, 221, 318 and 2113, among others.

Reference literature

[404, EPMF 2012].

7.3.2 Techniques to prevent and reduce emissions from PM smelting and melting operations (excluding those related to the production of Doré metal)

Description

The techniques to consider are:

- enclosed transfer systems for dusty materials (see Section 2.12.4);
- enclosed buildings and/or smelting furnace areas (see Section 2.12.4);
- operation under negative pressure;
- connecting furnace operations to dust collectors or extractors via hoods and a ductwork system (see Section 2.12.4);
- filtering collected or extracted dust in dedicated stand-alone or general plant units equipped with bag filters (occasionally, combined with cyclones) or cartridge filters;
- electrically interlocking furnace equipment with a dust collector or extractor.

In some sites, depending on their size and overall organisation (individual or annexed to other metal refining operations for instance), the recovery and treatment of dust generated from pyrometallurgical operations such as smelting are carried out in a such a manner that dust (and fumes) generated by pretreatment and handling and other dust-generating operations such as melting is captured, treated and controlled in a centralised manner. This explains the similarities between techniques described in Sections 7.3.1, 7.3.2, 7.3.3 and 7.3.8.

Technical description

Enclosed transfer systems for dusty materials

Dusty input materials are charged to the furnace via enclosed systems (conveyors, containers, sealed packaging); non-dusty material can be charged directly to the furnace via open boats/vessels under enclosed conditions.

Enclosed buildings and/or smelting furnace areas

Enclosed buildings can have appropriate extraction devices (e.g. building dedusting systems) or extractors at the transfer and tipping points, or equivalent measures (i.e. misting of material).

Connecting furnace operations to dust collectors or extractors via hoods and a ductwork system

Furnaces are encapsulated and connected to a hood. Enclosure or housing can be applied to the receiving ladle during the tapping/casting of metal/slugs. Ladles are kept within the enclosure until the material solidifies.

Furnaces can be covered by a water-cooled lid, which at the same time can be used as a hood for process off-gases. Additionally, the furnace can be placed inside an enclosure to capture diffuse emissions from the furnace.

Hoods/enclosures are connected to an exhaust system allowing dust and fume collection. The exhaust ventilation system can be connected to a gas abatement system present in the charging/tapping areas and casting areas.

Filtering collected or extracted dust

Bag filters and cartridge filters are used. The collected dust is returned to the process.

Achieved environmental benefits

- Reduction of dust emissions.
- The recovered flue-dust and filters from the dust collector are recycled within the refinery or by a third-party refiner for recovery of PM and other valuable metals, either by direct smelting or, after pretreatment, by pelletising or hydrometallurgical upgrading (no solid waste results from handling and pretreatment operations).

Environmental performance and operational data

Data from Plant 221 (see description of Plant 221 in Section 7.3.1) show that typical emissions from a medium-large cartridge filter unit containing eighty filters and with a fan rating of 30 000 m³/hour would be as follows.

Table 7.12: Dust emissions from PM Plant 221

Abatement technique	Values obtained	Dust	Method to obtain data	Type of average
		mg/Nm ³		
Cartridge filter	Average	1.12	Continuous monitoring	Monthly
	95th percentile	3.5		
	Maximum	4.38		

Source: [378, Industrial NGOs 2012]

In Plant 2426, the smelting operation consists of a rotary furnace which smelts all leady wastes which may contain silver. The releases from the smelter are particularly significant for lead but insignificant for silver, in that they arise chiefly from lead compounds and lead metal fume, whilst silver is present as a minor impurity. However, all solid materials (feed residues and internal process intermediates) are treated as potentially hazardous whether they are believed to contain lead or silver or not, as they may contain other substances that are toxic.

Typical smelting and melting operations responsible for generating dust and fume in Plant 2426 are summarised below:

- smelting of leady wastes containing silver as an impurity in a rotary furnace;
- casting of slag into blocks;
- casting of recovered lead containing the silver impurities.

The rotary furnace is connected front and rear via hoods and a ductwork system to a bag filter extraction unit. The extraction unit has a throughput capacity of 160 000 m³/h. In addition, the large front hood, which extracts from the door area and the casting area, is connected to two additional bag filtration units, each with a capacity of 34 000 m³/h. The dust and fume are extracted away from the processes and through the dust collectors, before the filtered air is released to atmosphere via a stack. Bag filters have a > 99.99 % capture efficiency for particles down to 0.5 microns.

Table 7.13: Dust emissions from PM Plant 2426

Abatement technique	Values obtained	Dust	Method to obtain data	Type of average
		mg/Nm ³		
Bag filter	Minimum	0.15	Continuous monitoring	Monthly average
	Average	0.3		
	Maximum	1.1		

Source: [378, Industrial NGOs 2012]

The recovered flue-dust is recycled within the refinery through the rotary furnace for the recovery of lead and silver. The stacks are fitted with particle-impact dust-measuring probes which trigger an alarm in the event of a fault developing. This is relayed to the 24-hour site security office, which then ensures that appropriate action is being taken. Probes are set to raise the alarm at a preset figure of 5 mg/m³ dust, as an hourly average.

All silver-producing processes are extracted to a common bag filtration unit. The typical silver content is ~ 1 % of the total mass and ~ 1.6 % of the typical lead content.

Plant 112 also reports emissions from a rotary furnace, shown in Table 7.14.

Table 7.14: Emissions from a rotary furnace in PM Plant 112

Abatement technique	Flow Nm ³ /h	Pollutant	Values	Unit	Method to obtain data	Type of average
				mg/Nm ³		
Cyclone, gas cooler, bag filter	36 090	Dust	Average	0.30	Periodic monitoring (6 times per year)	Over the sampling period
			Maximum	0.30		
		Total C	Minimum	0.6	Continuous monitoring	Half- hourly
			Average	6.7		
			Maximum	37.7		
		HCl	Average	0.13	Periodic monitoring (6 times per year)	Over the sampling period
		Cl ₂	Average	0.02		
			Maximum	0.04		
		PCDD/F	Average	0.024 ng I- TEQ/Nm ³		
			Hg	Minimum		
		Average		0.0032		
		Maximum		0.0095		
		Tl	Minimum	0.00002		
			Average	0.00003		
			Maximum	0.00003		
		Pb	Minimum	0.001		
			Average	0.0016		
			Maximum	0.0028		
		Co	Minimum	0.00002		
			Average	0.0001		
			Maximum	0.0004		
		Ni	Minimum	0.0008		
			Average	0.002		
			Maximum	0.0046		
		Se	Minimum	0.0407		
			Average	0.0469		
			Maximum	0.0572		
		Te	Minimum	0.00001		
			Average	0.0001		
			Maximum	0.0001		
		Sb	Minimum	0.0001		
			Average	0.0001		
			Maximum	0.0001		
		Cr	Minimum	0.0006		
			Average	0.0025		
			Maximum	0.0092		
		Cu	Minimum	0.0098		
			Average	0.0162		
			Maximum	0.026		
		Mn	Minimum	0.0004		
			Average	0.0031		
			Maximum	0.0106		
V	Minimum	0.00002				
	Average	0.00003				
	Maximum	0.00003				
Sn	Minimum	0.0004	Periodic	Over the		

			Average	0.0007	monitoring	sampling period
			Maximum	0.0018		
		As	Minimum	0.00003		
			Average	0.00005		
			Maximum	0.00011		
			Cd	Minimum		
		Average		0.0007		
			Maximum	0.0026		
			Cr(VI)	Minimum		
		Average		0.0002		
			Maximum	0.0003		
			Be	Minimum		
Average	0.000015					
		Maximum	0.00003			

Source: [378, Industrial NGOs 2012]

Cross-media effects

- Increase in energy use, in order to operate extraction and dedusting systems.
- Use of raw materials/fluxes to stabilise and maximise the efficiency of smelting reactions to prevent the formation of volatile metal compounds.

Technical considerations relevant to applicability

This type of dust collector is applicable for new installations and for major upgrades of existing installations.

Economics

A medium-large cartridge filter dust collector (80 filters) would have a capital and installation cost in the region of EUR 1–1.5 million at current prices.

Driving force for implementation

- Reduction of emissions.
- Environmental regulation requirements.
- To minimise the loss of valuable (precious) metals and to save and recover raw materials containing PM and other valuable metals.

Example plants

Plants 112, 121, 205, 221, 318, 2113 and 2426, among others.

Reference literature

[404, EPMF 2012]

7.3.3 Techniques to prevent and reduce emissions from pyrometallurgical processes for the production of Doré metal

Description

The techniques to consider are:

- encapsulated furnaces, appropriate housing/hoods, enclosures and covered washers; with efficient extraction and subsequent gas-cleaning systems (see Section 2.12.4);
- wet dedusting systems (quench, Venturi scrubbers, wet ESP);
- bag filter (see Section 2.12.5.1.4);
- SO₂ recovery in a sulphuric acid plant (see Sections 2.12.5.4.1 and 2.12.5.4.2) or SO₂ scrubber (peroxide process);
- recovery of selenium collected in the off-gas and precipitation from aqueous solution.

In some sites, depending on their size and overall organisation (individual or annexed to other metal refining operations for instance), the recovery and treatment of dust generated from pyrometallurgical processes for the production of Doré metal are carried out in a such a manner that dust (and fumes) generated by pretreatment and handling and other dust-generating operations such as melting is captured, treated and controlled in a centralised manner. This explains the similarities between techniques described in Sections 7.3.1, 7.3.2, 7.3.3 and 7.3.8.

Technical description

Encapsulated furnaces, appropriate housing/hoods, enclosures, and covered washers; with efficient extraction and subsequent gas-cleaning systems

Input materials such as anode slime are charged via closed and exhausted charging bins and conveyors to the dryer. Dusty materials are stored in closed big bags and charged to the Kaldo/TBRC furnace via closed bins with an exhaust system in a completely enclosed system. Non-dusty and large materials can be charged directly to the furnace via open boats/vessels under enclosed conditions too. Handling takes place under a hood.

Operation takes place under negative pressure. The Kaldo/TBRC furnace is encapsulated and connected to a hood. The receiving ladle is enclosed or housed during tapping/casting of metal/slugs. Ladles are kept within the enclosure until the material solidifies. The cupellation furnace (TBRC/TROF/BBOC) for the refining of precious-metal-enriched alloys from copper/lead lines is charged with large materials that do not contain sulphur and selenium. The furnace is covered by a water-cooled lid, which at the same time is used as a hood for process off-gas. Additionally, the furnace is placed inside an enclosure to capture diffuse emissions. Sodium carbonate and other fluxes for the refining process are stored in closed bins and charged through a closed system.

Doré metal may also be produced as a result of the removal of zinc by evaporation under a vacuum in a vacuum retort (VR). No fluxes are required. This is a closed process. Moulding into bars is carried out under an extraction hood and the extracted air is filtered via bag filters.

Hoods/enclosures are connected to an exhaust ventilation system allowing fume collection. The exhaust ventilation system is connected to the gas abatement system present in charging/tapping areas, as well as in casting areas for Doré/silver anodes.

Wet dedusting systems, bag filters and SO₂ recovery in a sulphuric acid plant or SO₂ scrubber (peroxide process)

Process off-gases from furnaces (melting/converting stage containing volatilised selenium) are cooled/quenched and treated in a Venturi scrubber, a wet cyclone and/or a wet electrostatic precipitator. SO₂ removal, if necessary, is achieved by a double contact/double absorption acid plant or a SO₂ washing tower or by a SO₂ scrubber. Off-gases from the separate roasting of selenium are captured by dedusting systems aimed at removing all dust.

Dry process off-gases from furnaces (cupellation furnace for smelting Doré / final refining stage or melting after pre-roasting, not containing volatilised selenium) can be treated in bag filters.

Secondary gases from various sources are usually mixed and treated in bag filters.

Recovery of selenium and valuable metals

Selenium is volatilised and recovered from smelting off-gas using a Venturi scrubber and/or a wet ESP. The suspension obtained in the wet dedusting systems is treated with sodium hydroxide and/or filtered by an (indirect steam-heated) filter press. The filtered slime is returned to the process. The solution is further heated and treated with gaseous sulphur dioxide in order to precipitate the selenium. The remaining effluent is treated in a waste water treatment plant (physical and chemical treatment) or recycled in an acid plant.

Selenium-containing slimes can also be roasted prior to smelting. Selenium is evaporated in an electrically heated furnace as selenium dioxide gas using oxygen and sulphur dioxide as

reagents. Selenium is removed from the off-gas into an aqueous solution and reduced to elemental selenium.

Process residues such as slags from different stages of the refining process, dust separated in bag filters, residues of the wet dedusting system, etc. are recycled internally or externally for metal recovery.

Achieved environmental benefits

- Prevention and reduction of dust, metals and SO₂ emissions.
- For those sites annexed to sulphuric acid plants, SO₂ emissions are recovered to produce sulphuric acid for reuse on site and/or sale to third parties.
- Selenium is recovered from the furnace off-gas.
- All residues generated in the wet dedusting systems which are likely to contain valuable metals (filtered slime) are returned to the refining process. The collected flue-dust in bag filters is recycled within the refinery or by a third party for recovery of PM and other valuable metals, hence promoting raw material savings and minimisation of waste streams.

Environmental performance and operational data

In Plant 117, the precious metals refining activity is annexed to a copper refining facility and, as such, the main raw material fed into the Doré production process is dried copper anode slimes, as well as other returned materials from precious metal production processes. Slimes are first dried in an indirect steam-heated dryer. Dried material is hermetically transferred to the charging bin of the Kaldo furnace and then (also hermetically) into the furnace itself. Some other charging materials, like returned crushed slag or silver cement, are (without drying) fed straight to the charging bin, from where they are hermetically charged into the Kaldo furnace. The auxiliary materials are fed straight to the Kaldo furnace through its throat. All charging areas are equipped with ventilation systems. The Kaldo furnace is completely encased by a hood.

Off-gases from the Kaldo furnace are dedusted in a Venturi scrubber and sent (as an additional gas stream) to a double contact/double absorption sulphuric acid plant located in the copper smelter. The stream of Kaldo flue-gas, containing 1.5–12 g/m³ SO₂, makes up about 4 % of the total stream entering the sulphuric acid plant.

Table 7.15: Emissions from PM Plant 117

Abatement technique	Pollutant	Values obtained	Unit	Method to obtain data	Type of average
			mg/Nm ³		
Venturi scrubber and double contact/double absorption sulphuric acid plant followed by demister	SO ₂	Minimum	140	Continuous monitoring	Hourly
		Average	186		
		Maximum	800		
	NO _x	Minimum	280		
		Average	299		
		Maximum	640		
	H ₂ SO ₄	Minimum	37	Periodic monitoring (12 times per year)	Over the sampling period
		Average	77		
		Maximum	200		

Source: [378, Industrial NGOs 2012]

There is a central ventilation system in the precious metals plant, equipped with two bag filters and two stacks. The system collects emissions from:

- off-gas from the dryer;
- the raw material handling hall;
- the Kaldo furnace hood and anode furnace aisle;

- ventilation air from the dryer charging area and the charging bin;
- the preliminary slag crushing area;
- other facilities of the precious metals plant.

Table 7.16: Emissions from the central ventilation system in PM Plant 117

Abatement technique	Pollutant	Values obtained	Unit	Method to obtain data	Type of average
			mg/Nm ³		
Bag filter	Dust	Minimum	0.1	Periodic monitoring (4 times per year)	Over the sampling period
		Average	0.23		
		Maximum	0.3		
	SO ₂	Minimum	14.6		
		Average	40.15		
		Maximum	64.24		

Source: [378, Industrial NGOs 2012]

The suspension obtained in the wet dedusting system is neutralised with sodium hydroxide. Lead and other residue metals precipitate. The pulp is filtered in a filter press. The filtered slime is returned to the dryer. The solution is heated and treated with gaseous sulphur dioxide, while selenium precipitates. The selenium is then filtered and rinsed in a filter press and dried with blown air. Waste water is discharged to the local waste water pretreatment plant, where it is neutralised with lime milk and filtered. The slime is returned to the copper concentrate stream to be briquetted and charged into shaft furnaces for copper smelting. The filtered solution is discharged into the copper smelter's acid waste water sewer for final neutralisation and coagulation.

Doré metal from the Kaldo furnace is transferred to the anode furnace in a ladle which is transported by an overhead crane. Crude silver is heated and cast into silver anodes. The anode casting hall is equipped with LEV (local exhaust ventilation). Ventilation gases from the anode furnace aisle as well as process gases from the furnace are dedusted in a bag filter. Dust from the bag filter is returned to the Kaldo furnace through a closed pipe system.

In Plant 121, the precious metal refinery is designed to refine both the precious-metal-enriched anode slimes from copper production and the precious-metal-enriched alloy from lead refining. The decoppered slime is dried. The dried slime is melted in a Kaldo/TBRC furnace to separate the base metals from the slag and retain the crude PM alloy. The selenium is volatilised, collected during gas scrubbing and precipitated as crude selenium which is sold for further refining. The precious-metal-containing alloys from the different production lines (lead, copper, market) are mixed and melted in a second furnace (TROF, TBRC), where finally the PM alloy/rich Doré metal/raw silver is refined and cast into silver anodes.

Anode slime is charged via closed charging bins and enclosed conveyors to the dryer. Converters and bins are emptied. Dusty materials are stored in big bags and charged from the big bags to enclosed bins which are exhausted. Non-dusty/large materials are charged via boats/vessels. The TBRC furnace is charged via a completely enclosed system.

The dryer is indirectly heated by a steam dryer and is charged via a closed charging conveyor (exhaust system). The gas is treated together with the secondary off-gas from the Kaldo furnace (TBRC 1) and the lead refinery in a bag filter. Closed bins are used to store and charge dried material.

The Kaldo furnace (TBRC 1) is encapsulated and connected to a hood. Primary process gases are rapidly cooled in a quench (from 600 °C to 80 °C), then pass through a Venturi scrubber, wet cyclone and wet ESP. The gas is treated for SO₂ recovery in a double contact/double absorption acid plant or a SO₂ scrubber. Dust suspension from the quench and Venturi scrubber is filtered by an (indirect steam-heated) filter press and the slime is recirculated back to the

TBRC. Aqueous solution is reused in the wet gas cleaning to concentrate selenium and is further used for the precipitation of crude selenium. The SO₂ content in gas discharged from the sulphuric acid plant is around 270–1080 mg/m³ (daily average).

Secondary gases from various sources (e.g. the Kaldo furnace (TBRC 1) and the lead refinery) are mixed together and cleaned in two bag filters.

Table 7.17: Dust emissions from secondary gases in PM Plant 121

Abatement technique	Maximum flow	Values obtained	Dust	Method to obtain data	Type of average
	Nm ³ /h		mg/Nm ³		
Bag filter	40 000	Minimum	< 0.5	Continuous monitoring	Daily
		Maximum	2.0		
		Minimum	< 0.5		Half-hourly
		Maximum	8.0		

Source: [378, Industrial NGOs 2012]

The cupellation furnace (TBRC 2) is placed inside a large enclosure. Large solid materials that do not contain sulphur and selenium are charged. Sodium carbonate and other fluxes for the refining process are stored in closed bins and charged through a closed system. The furnace is covered by a water-cooled lid, at the same time used as a hood for process off-gases. Additionally, the furnace is placed inside an enclosure to capture fugitive emissions. Both hoods are connected to exhaust ventilation. The off-gas of the cupellation furnace (TBRC 2) together with the secondary gases are cleaned in a separate bag filter.

Table 7.18: Dust emissions from several sources (cupellation furnace and secondary gases) in PM Plant 121

Abatement technique	Maximum flow	Values obtained	Dust	Method to obtain data	Type of average
	Nm ³ /h		mg/Nm ³		
Bag filter	50 000	Minimum	< 0.5	Continuous monitoring	Daily
		Maximum	2.0		
		Minimum	< 0.5		Half-hourly
		Maximum	4.0		

Source: [378, Industrial NGOs 2012]

At Plant 27, the separation and recovery of selenium are carried out by roasting decoppered anode slime and by evaporation of selenium dioxide gas in an electrically heated furnace using oxygen and sulphur dioxide as reagents. Selenium is then removed from the off-gas into an aqueous solution and reduced to elemental selenium. Dust is captured in precipitation solution tanks. The average dust content in the off-gas after selenium precipitation is < 25 mg/Nm³. Selenium-free slime is then smelted, reduced and refined in a TROF converter as Doré metal and cast as anodes. Off-gases are routed into two bag filters, one for process gas and one for ventilation gas. The dust content in the combined off-gas stream (18 000 Nm³/h) after the bag filter is shown in Table 7.19.

Table 7.19: Dust emissions in PM Plant 27

Abatement technique	Values obtained	Dust	Method to obtain data	Type of average
		mg/Nm ³		
Bag filter	Average	10	Periodic monitoring (4 times per year)	Over the sampling period

Source: [378, Industrial NGOs 2012]

At Plant 219, the drying of leached anode slime and mixing of slag fluxes (e.g. sodium carbonate and coke) are applied, followed by smelting and converting in a TBRC for impurity removal and the production of Doré metal in the form of anodes. Selenium is separated by volatilisation and recovered from the gas phase by a Venturi scrubber and in a wet ESP, before being finally precipitated as raw selenium. Gases are also cleaned for sulphur dioxide in an ESP and a washing tower. Off-gas from the secondary hood and concentrate dryer is cleaned in a bag filter. Table 7.20 shows the dust emissions.

Table 7.20: Dust emissions in PM Plant 219

Abatement technique	Flow	Values obtained	Dust	Method to obtain data	Type of average
	Nm ³ /h		mg/Nm ³		
ESP + scrubber	7 000	Minimum	< 0.5	Periodic monitoring (4 times per year)	Over the sampling period

Source: [378, Industrial NGOs 2012]

At Plant 2113, Doré metal is produced from various intermediates containing high concentrations of PM. Lime is injected in order to remove the SO₂ from the furnace off-gases with a bag filter, where the dust is also removed. The building ventilation air is cleaned with a bag filter. Table 7.21 shows the dust emissions from the process gases and Table 7.22 the dust emissions from the building ventilation air.

Table 7.21: Emissions from process gases in PM Plant 2113

Abatement technique	Flow (Nm ³ /h)	Pollutant	Values obtained	Unit (mg/Nm ³)	Method to obtain data	Type of average
Bag filter with lime injection (process gases)	18 500	Dust	Minimum	0.02	Periodic monitoring (5 times per year)	Over the sampling period
			Average	0.10		
			Maximum	0.14		
		SO ₂	Minimum	62	Periodic monitoring (15 times per year)	
			Average	248		
			Maximum	620 ⁽¹⁾		

⁽¹⁾ Values correspond to 1–2 hour samples. For the duration of the whole cycle (approximately 12 hours), values reported ranged between 250 mg/Nm³ and 480 mg/Nm³.

Source: [378, Industrial NGOs 2012]

Table 7.22: Emissions from building ventilation air in PM Plant 2113

Abatement technique	Flow (Nm ³ /h)	Pollutant	Values obtained	Unit (mg/Nm ³)	Method to obtain data	Type of average
Bag filter (building ventilation)	115 000	Dust	Average	0.05	Periodic monitoring	Over the sampling period
			90 th percentile	0.06		

Source: [378, Industrial NGOs 2012]

In Plant 2426, Doré metal is produced from silver impurities that are removed from lead during lead refining. Air emissions prevention measures such as encapsulated furnaces and appropriate housing/hoods are in place. During the casting of blocks, the process gas is extracted via an extraction hood connected to a bag filter with a capacity of 160 000 m³/h which serves the silver circuit processes. Filter dust is charged to the silver rotary furnace for recovery of metals. In Plant 2426, Doré metal comprises impure silver resulting from the removal of zinc from silver during silver refining. Removal of zinc is by evaporation under a vacuum using a vacuum retort. Doré metal is cast from the process into moulds, under an extraction hood connected to the bag filter described above which serves the silver circuit processes, to form solid bars of silver with lead and copper impurities, with a silver content which may fall below 80 %.

In Plant 2426, the gases from all silver-producing processes are extracted to a common bag filter. The typical silver content is ~ 1 % of the total mass and ~ 1.6 % of the typical lead content.

Cross-media effects

- Increase in energy use to operate extraction, filtration, dedusting, and scrubber systems.
- Use of fluxes to maximise efficiency of smelting reactions and to prevent the formation of volatile metal compounds.
- SO₂ removal requires reagents (e.g. H₂O₂ for scrubbers or lime injection in bag filters).

Economics

No information provided.

Technical consideration relevant to applicability

The techniques are applicable to new and existing plants.

Wet dedusting systems and recovery of selenium are applicable for off-gas containing volatilised selenium.

Bag filters are generally applicable for dry gases (not containing volatilised selenium) and for ventilation gases.

Recovery of SO₂ in a double contact/double absorption acid plant is predominantly applied for precious metal refineries that are installed in primary copper production sites, as these are equipped with sulphuric acid production units. Alternatively a SO₂ scrubber is applied.

Driving force for implementation

- Prevention and reduction of emissions.
- Environmental regulation requirements.
- To minimise the loss of valuable (precious) metals and to save and recover raw materials containing PM and other valuable metals.

Example plants

Plants 27, 117, 121, 318, 2113 and 2426, among others.

Reference literature

[404, EPMF 2012]

7.3.4 Techniques to prevent and reduce emissions from (electrolytic) silver and gold refining**Description**

The techniques to consider are:

- process-control-integrated measures;
- closed tanks/vessels and closed pipes for transfer of solutions (see Section 2.12.4);
- hoods and extraction systems for electrolytic cells, where relevant (e.g. gold electrolysis) (see Section 2.12.4);
- water curtain;
- recirculation of solutions for reuse;
- recycling of by-products for precious metals recovery;
- recovery of nitric acid from high-concentration NO_x gases;
- alkaline scrubber with caustic soda solution for gold electrolysis exhaust gas (see Section 2.12.5.2.2).

Technical description

Silver electrorefining is performed in electrolytic cells, using titanium or stainless steel cathodes and silver anodes cast from Doré. They are immersed in acidified silver nitrate electrolyte. A direct current applied between the electrodes causes silver ions dissolved from the anodes to migrate and deposit on the cathodes as silver crystals. The crystals are scraped from the cathodes, collected and removed from the bottom of the cells, washed, filtered and dried. Part of the electrolyte is periodically removed from the system for purification and recovery of silver through cementation.

The slimes from the electrolytic cells, collected in anode filtration bags, are washed, filtered and further treated for their gold and PGM content. Gold is produced via gold electrolysis or hydrometallurgical processes following the leaching of the anode slime with nitric acid. After leaching, the gold sand is cast into anodes. The electrolyte used is a solution of hydrochloric acid and tetrachloroauric acid. A direct electric current applied between the electrodes causes gold ions dissolved from the anodes to migrate and deposit on the cathodes.

Gold can also be recovered by the leaching of the slimes/gold sand with hydrochloric acid in the presence of oxidants (HNO₃, Cl₂, H₂O₂, etc.), followed by selective reduction and precipitation from the solution.

Process-control-integrated measures

Electrorefining processes are optimised in terms of cell design, anode cathode spacing, current density, electrolyte composition, temperature and flow rate in order to achieve low energy consumption and maintain high productivity.

Closed tanks/vessels and closed pipes for transfer of solutions

Closed vessels/storage tanks for electrolytes and closed vessels for the addition of reagents (copper powder, soda) for spent electrolyte purification and cementation of silver are used. Storage tanks/vessels are double-walled tanks or placed in resistant bunds. The floor is impermeable to water and acid-resistant. Closed pipelines are used for the transfer of solutions/electrolytes.

Silver crystals are transferred via closed conveyors to collecting vessels or lifted with collecting trays from the cell bottom.

The leaching of anode slime with nitric acid (prior to gold electrolysis) takes place in closed vessels.

Closed reaction vessels with exhaust ventilation are also used for the leaching of anode slime with hydrochloric acid or other solvents or solvent mixtures, and in further steps for the reduction and precipitation of gold.

The regular inspection and preventive maintenance of cells, tanks, pipes, pumps and cleaning systems are applied to ensure liquid-tightness and prevent leaks.

Hoods and extraction systems for electrolytic cells, where relevant (e.g. gold electrolysis)

Slime washing takes place within housing or an enclosure.

Electrolytic cells for gold electrolysis are equipped with hoods/integrated enclosures and exhaust ventilation to capture chlorine that is generated at the anode.

Water curtain

This can be used to prevent chlorine gas emissions during the leaching of anode slime with hydrochloric acid or other solvents.

Recirculation of solutions for reuse

Drainage systems are sealed and all collected solutions are recirculated.

Recycling of by-products for precious metals recovery

- Spent electrolyte from silver electrolysis and spent slime washing solutions are purified to recover silver. Spent anodes are remelted for metal recovery. Residues from electrolyte purification (silver cement, copper-carbonate-based residue) are recycled internally for metal recovery.
- Electrolyte from gold electrolysis is purified to recover gold. Spent anodes are remelted for metal recovery. Slimes containing gold and other PGMs are recovered and further refined.
- Solutions from gold leaching processes are purified to recover gold and PGMs.
- PGM-enriched solutions are used for the internal or external recovery of PGMs.

Recovery of nitric acid from high-concentration NO_x gases

NO_x-containing gases from the leaching of anode slime with nitric acid are collected via a dedicated ductwork system, and washed and/or treated in scrubbers for recovery of the nitric acid.

Alkaline scrubber with caustic soda solution for gold electrolysis exhaust gas

Exhaust gas from gold electrolytic cells is collected and cleaned in an alkaline scrubber containing aqueous caustic soda solution.

Achieved environmental benefits

- Prevention of diffuse emissions.
- Efficient energy use.
- Recovery of metals and raw materials savings.
- No waste is generated from the processes.

Environmental performance and operational data

In Plant 117, the room where silver electrorefining and silver cementation takes place is equipped with a supply-exhaust ventilation system connected to the exhaust stack on the roof, though emissions to air are negligible.

Crystals of silver are collected from the bottom of the cells, washed with (chlorine-free) hot water, filtered, and dried by blown hot air. Spent anodes are returned to the anode furnace. Spent electrolyte is withdrawn and cemented with copper powder. After filtration, silver

cement is returned to the Kaldo furnace, while the solution is discharged into the local waste water pretreatment plant, where it is neutralised with lime milk and filtered. The slime of the water pretreatment plant is returned to the copper concentrate to be briquetted and charged into the shaft furnaces for copper smelting. The filtered solution is discharged into the copper smelter's acid waste water sewer for final neutralisation and coagulation.

The anode slime from the silver electrorefining process is rinsed with chlorine-free water, filtered and collected for gold and other precious metals recovery. Gold is recovered by leaching the slimes with hot hydrochloric acid and chlorine gas and is then precipitated from the solution. The reaction vessels for gold leaching are closed. The water curtain prevents the release of chlorine gas. When the leaching process is over, all residue gases are directed to the sulphuric acid plant for treatment. Gold dust precipitates with the use of NaHSO_3 and NaOH , and it is then filtered and melted into bars. The remaining solutions from the pre-leaching process and precipitation are used externally for the recovery of platinum. Precipitate from the leaching process is cemented with iron powder and, after filtration, is returned to the Kaldo furnace. The filtrate is discharged into the local waste water pretreatment plant.

No solid waste for disposal is produced from the processes.

At Plant 121, silver electrolysis is applied for the production of high-purity silver crystals and for separating gold and PGMs in the anode slime. Slime is washed with water within housing and solution is recirculated. Spent electrolyte combined with spent washing solution is treated with copper powder for the precipitation of silver and is further treated with soda to remove impurities. Silver cement is recycled in the TBRC furnace. Copper-carbonate-containing residue is recycled in the primary copper smelter. Vessels for the addition of copper powder and soda are closed. A closed vessel/storage tank is used for electrolyte. Silver crystals from the bottom of the cells are pumped via a closed conveyor to collecting vessels and then further washed with water to remove the remaining electrolyte.

The anode slime is leached with nitric acid prior to casting into anodes for the gold electrolysis. Leaching takes place in a closed, heated vessel. NO_x gases are washed and a solution of nitric acid is recovered. The off-gas from the scrubber has a maximum flow rate of $20\,000\text{ Nm}^3/\text{h}$; measurements are performed for NO_x once a year (three 30-minute measurements): measured levels are in the range of $80\text{--}110\text{ mg/Nm}^3$. The remaining PGM-containing solution is used externally for recovery of PGMs.

Gold can be produced as high-quality gold cathodes in a gold electrolytic process or via leaching as a highly purified gold precipitate. Gold electrolytic cells and reactors are connected to hoods and exhaust gases are cleaned in a scrubber containing aqueous caustic soda solution. The off-gas flow rate is up to $5000\text{ Nm}^3/\text{h}$; measurements are performed for Cl (HCl) once a year (three 30-minute measurements): measured levels are in the range of $2\text{--}12\text{ mg/Nm}^3$. Spent electrolyte is cleaned for gold recovery and the remaining solution is used externally for the recovery of platinum group metals. Slime is reused for gold/PGMs recovery.

In Plant 27, the silver electrorefining room is equipped with a supply-exhaust ventilation system connected to the exhaust stack on the roof. Spent anodes are returned to the TROF. The spent electrolyte and waste water from washing cathode silver and spent anodes undergo cementation with copper powder. Silver is also cemented with powdered iron from AgCl slime obtained from leaching gold from the silver electrorefinery anode slime. After cementation, the filtered silver cement is returned to the TROF, while the solution is recycled back to the PM process. No solid waste from the process is produced for disposal.

Technical considerations relevant to applicability

Process-control-integrated measures, closed tanks/vessels and closed pipes for the transfer of solutions, and the recirculation of solutions for reuse are generally applicable.

The recycling of by-products/solutions for precious metals recovery is generally applicable depending on the particular stream and precious metals content (gold, silver or platinum group metals); if none are contained, recycling will not be performed.

Hoods and extraction systems are applicable for gold electrolytic cells.

The water curtain is applicable to prevent the release of chlorine gas during leaching processes (e.g. during gold production).

The recovery of nitric acid is applicable for gases with a high NO_x concentration, e.g. from processes involving the leaching of anode slime with nitric acid.

The alkaline scrubber with caustic soda solution is applicable for gold electrolysis exhaust gas.

Economics

No information provided.

Driving force for implementation

- Prevention and reduction of emissions.
- Environmental regulation requirements.
- To minimise the loss of valuable (precious) metals and to save and recover raw materials containing PM and other valuable metals.

Example plants

Plants 27, 112, 117, 121, 205 and 318, among others.

Reference literature

[404, EPMF 2012]

7.3.5 Techniques to prevent and reduce emissions from PM hydrometallurgical operations

Description

The techniques to consider are as follows:

- Containment measures, such as sealed or enclosed reaction vessels, storage tanks, solvent extraction equipment and filters, vessels and tanks fitted with level control, closed pipes, sealed drainage systems and planned maintenance programmes (see Section 2.12.4).
- Reaction vessels and tanks connected to a common ductwork system with off-gas extraction (automatic standby/back-up unit available in case of failure) (see Section 2.12.4).
- Sulphuric acid scrubber system to treat ammonia (see Section 2.12.5.2.2).
- Wet alkaline scrubber system containing aqueous caustic soda to treat acidic off-gases such as hydrochloric acid, chlorine and NO_x (see Section 2.12.5.2.2).
- NO_x scrubbers containing an aqueous mixture of hydrogen peroxide and nitric acid (see Section 2.12.5.2.2). These scrubbers are located on specific vessels which have the potential to generate high, localised concentrations of NO_x. The aim of these mini-scrubbers is to reduce the load of the main system.
- Control systems, such as connecting scrubbers on a priority electricity circuit served by a back-up generator in the event of a power failure and for operating start-ups and shutdowns; spent acid disposal and fresh acid make-up of scrubbers via an automated control system, assuring the availability of a back-up scrubbing-liquid-circulating pump from each scrubber reservoir in case of a pump failure.

Technical description

For the separation and purification of PM- and silver-containing materials, a variety of hydrometallurgical techniques are employed, including dissolving/leaching with hydrochloric acid, hydrochloric acid and chlorine, nitric acid, aqua regia (nitric acid and hydrochloric acid), distillation, filtration operations and selective extraction processes (including solvent extraction and ion exchange).

The chemistry undertaken in these operations in a complex PM hydrometallurgical operation results in a range of toxic and potentially environmentally damaging off-gases, which require treatment to reduce them to acceptably low concentrations before being released to atmosphere.

The vast majority of reactions result in acidic off-gases, amongst which the most significant are hydrochloric acid, chlorine and NO_x. In addition, some reactions result in the emission of small quantities of SO₂, bromine and sulphuric acid vapour.

There are also a number of operations throughout a PM refinery in which ammonia is the primary off-gas produced from the reaction vessels. This can be from any PM refining operation, but it is usually associated with palladium refining with solvent extraction and related operations, where ammonia is used as a reagent, and in the caustic soda treatment of PM liquors containing ammonium chloride, which releases ammonia.

Containment measures

All refineries using hydrometallurgical processes to refine PMs handle a complex range of aqueous liquors and, frequently, organic solvents. Many of the aqueous liquors will be either highly acidic or alkaline and, if accidentally released to the environment, have the potential to cause significant damage. In addition, many of the materials are handled at elevated temperatures so there is also the potential for the release of toxic gases. It is therefore necessary to have in place a series of containment measures to minimise the risk of both diffuse emissions and accidental releases.

All reaction vessels are sealed during operation, usually by clamping down the charge hole lid. They are normally only opened at the start of a process, during charging, or occasionally for sampling purposes. The use of closed reaction vessels also significantly reduces the duty of the off-gas treatment installation in comparison to ventilated reactors, hence lowering the consumption of chemicals, power and water. Vessels are always under negative pressure and all fumes generated during operations are extracted to a dedicated gas scrubbing plant.

Storage tanks, both internal and external, are sealed and usually fitted with a closable inspection hatch or port. These are only opened when the tanks are empty for maintenance purposes, etc. Storage tanks are also connected to the local exhaust ventilation (LEV) system and the fume directed to the appropriate gas scrubbing plant.

Solvent extraction equipment and filters are normally located within purpose-built housing fitted with LEV or under extraction hoods. The housing is typically made of transparent perspex or other plastic, so that operations can be viewed without exposure of workers or potential release of fumes, etc. to the workplace or environment. The plastic panels are removable for maintenance purposes.

Most reaction vessels and storage tanks are fitted with an automatic level control. This means that, when filling a tank or vessel, a transfer pump will automatically cut out when the desired level has been reached. In addition, high-level alarms are fitted which will warn operators if this level has been breached. These controls minimise the risk of tanks and vessels being overfilled and a spillage occurring.

All aqueous solutions and solvents are transferred between vessels, tanks, etc. through closed pipes to eliminate any contact with operators. Construction materials should be compatible with the type of liquor being transferred. In many cases, external pipes are fitted within secondary

clear plastic housing, which enables leaks to be quickly identified whilst preventing any spillage.

Reagent and intermediate storage tanks are constructed of materials compatible with the liquor contained. Typically, in many PM refineries these include high-specification reinforced plastic materials that are corrosion-resistant. External storage tanks are always located in bunded areas, where any accidental spillage can be retained and recovered. These bunded areas are made of acid-resistant materials or similar to eliminate any seepage to the ground. All internal floors are usually tiled to prevent any seepage to the ground, and are fitted with sumps to collect any accidental spillage. It is also good practice to bund individual buildings by constructing floor humps at doorways, to prevent any run-off in the event of a major vessel or tank failure.

It is standard practice for all drainage systems to be sealed so that, in the unlikely event of spillage, no liquor can enter the drainage system and be released into the public sewer or natural environment. Drainage systems are also normally fitted with interceptor tanks, so that if any liquor were to enter the system it would be retained. Interceptor tanks and outfall points may also be fitted with pH alarms, which will warn of any release and automatically shut off any discharge to the sewer, etc.

All PM refineries adopt rigorous, planned maintenance programmes to inspect and repair all equipment, and to minimise and prevent any emissions, leaks or spillages.

Reaction vessels and tanks connected to a common ductwork system with off-gas extraction (automatic standby/back-up unit available in case of failure)

All reaction vessels and tanks, etc. with the potential to emit ammonia gas or acidic gases are connected to a common ductwork system (normally via a glass water-cooled condenser) where a fan extracts the off-gases from the vessel. The duct transports the off-gas to the scrubber plant.

Scrubber system containing sulphuric acid solution

The scrubber plant typically consists of one or more gas scrubbing towers with a reservoir of sulphuric acid solution (i.e. 15 wt/vol-%) which is circulated around the scrubbing tower. Where more than one tower operates in the gas scrubbing system, the vast majority of ammonia off-gas is absorbed in the first scrubbing unit whilst the other serves as a second stage and/or a back-up unit in the event of failure of the first.

In terms of operating practice, the key parameter is the monitoring and control of acidity in the scrubbing liquid reservoir(s). The pH of the scrubbing liquid reservoir(s) is monitored and adjusted continuously.

The off-gases leaving the scrubber plants are released to the atmosphere via a dedicated stack.

Wet alkaline scrubber system containing aqueous caustic soda

Scrubber plants typically consist of one or more gas scrubbing towers with a reservoir of aqueous caustic soda solution which is circulated around the scrubbing tower. When more than one tower operates in the gas scrubbing system, the vast majority of acidic off-gases are absorbed in the first scrubbing unit, whilst the other serves as a second stage and/or a back-up unit in the event of failure of the first.

In terms of operating practice, a key parameter is the monitoring and control of alkalinity in the scrubbing liquid reservoirs. Another key parameter is the temperature of the scrubbing liquid which needs to be controlled below a set point to ensure good removal of NO_x and other acidic gases.

The off-gases leaving the scrubber plants are released to atmosphere via a stack, which would normally be one of the main controlled, gaseous release points from a PM refinery. Because of the potential significance of NO_x as an atmospheric pollutant, stacks may be fitted with a sample probe and gas transfer line connected to a dedicated NO_x monitor which is operated

continuously. Additionally, real-time NO_x levels are relayed continuously via the automated control system to a local panel or central control room, activating alarms at 'warning' and 'action' levels to alert those responsible for operating known NO_x-producing reactions, so that steps may be taken to limit/control its production at source.

NO_x scrubbers containing an aqueous mixture of hydrogen peroxide and nitric acid

Because of its potential significance as an atmospheric pollutant, special attention is given to monitoring and controlling the release of NO_x from a PM refinery. Monitoring can be done by continuous measurements or by discrete regular sampling and analysis of the output of the stack.

Scrubbing is performed to achieve NO_x emission limit values and avoid brown fumes at the plant stack. NO_x scrubbers are used (in addition to the main scrubbing system) for specific vessels which have the potential to generate high, local concentrations of NO_x. The aim of these mini-scrubbers is to reduce the load of the main system. Nitrogen oxide off-gases (NO and NO₂) can be captured, using oxygen or hydrogen peroxide as oxidation agents on the one hand, and nitric acid or urea (as reducing agents) on the other hand. Residence time and cooling of the circulating scrubbing liquid are essential to obtain optimal gas absorption and achieve the NO_x emission limits. The off-gases from the NO_x scrubber are diverted to caustic scrubbers (as described above) before release to the atmosphere.

The circulating scrubbing liquid is either acidic (diluted nitric acid and hydrogen peroxide) or alkaline (caustic soda, with hydrogen peroxide). In concentrated NO_x streams from closed refining operations, acidic scrubbing is preferred, since the absorbed NO_x can be converted and concentrated up to 50 wt-% nitric acid, enabling the recycling of the acid to the refining operations.

Control systems

It is good practice to have the scrubber plant on a priority electricity circuit, which is served by a back-up generator in the event of a power failure.

Also, the scrubbing-liquid-circulating pump from each scrubber reservoir should have a back-up which comes on automatically in the event of a pump failure. And the fan to pull the off-gases through the system should also have a standby back-up unit.

In order to minimise dilution and maximise residence time in the scrubbers, scrubber feed and management systems are linked to an automated control system such as a PLC or DCS.

Achieved environmental benefits

- Prevention and reduction of emissions to air and water.
- Recycling/use of spent/recovered scrubbing liquids and other hydrometallurgical reagents in leaching and other PM refining operations. Spent scrubbing liquid used for the reduction of the gaseous ammonia emissions (aqueous ammonium sulphate) can be sent to the WWTP, used internally as a reagent, or removed by a contractor (who may use it as a by-product for crystallisation to ammonium sulphate for use as fertiliser). Spent scrubbing liquid from the NO_x scrubbers (nitric acid) can be recycled internally in the refining operations. Spent scrubbing liquid used for the reduction of the acidic gaseous emissions, essentially sodium chloride from neutralisation of hydrochloric acid with caustic soda but containing residual alkali, some hypochlorite and other products from the absorption of off-gases, is a significant source of the aqueous effluent sent to the WWTP or removed from the site by a licensed waste contractor. The contractor may use the liquid as an alkali/oxidant in their base metal treatment precipitation processes.

Environmental performance and operational data

In Plant 221, the ammonia and acid scrubber releases are monitored before release to atmosphere via the corresponding stacks.

Table 7.23: Emissions from scrubbing processes in PM Plant 221

Abatement technique	Pollutant	Values obtained	Unit	Method to obtain data	Type of average
			mg/Nm ³		
Ammonia scrubber (sulphuric acid as scrubbing medium)	NH ₃	Maximum	< 1	Periodic monitoring (12 times per year)	Average over the sampling period
Alkaline scrubber	NO _x as NO ₂	Average	3.07	Continuous monitoring	Hourly average
		95th percentile	22.54		
		Maximum	70.71		
	Chlorine	Maximum	< 3	Periodic monitoring (52 times per year)	
Gaseous chlorides (as HCl)	Maximum	< 1.5			
Alkaline scrubber	NO _x as NO ₂	Average	0.76	Continuous monitoring	
		Percentile 95 %	3.69		
		Maximum	25.82		
	Chlorine	Maximum	< 3	Periodic monitoring (52 times per year)	
	Gaseous chlorides (as HCl)	Maximum	< 1.5		

Source: [378, Industrial NGOs 2012]

Plant 1019 reported using counterflow acidic scrubbers and having NH₃ emissions of 2.72 mg/Nm³ as an average value (the reported maximum is higher than the reported ELV). This plant also reported average values of 16.4 mg/Nm³ for HCl (maximum values of 50 mg/Nm³) and average values of 1.8 mg/Nm³ for Cl₂ (maximum values of 5.9 mg/Nm³) [378, Industrial NGOs 2012].

Plant 1315 specialises in the recovery of copper and other valuable metals from scrap copper and other secondary materials with copper content. The procedure developed by this plant for the production of high-grade gold, silver and platinum/palladium from the copper anode slime is a purely hydrometallurgical process. There are no emissions to air.

Any anode slime that arises is mostly cleaned of copper and nickel by leaching in sulphuric acid. This sludge is treated in solution reactors in separate silver and gold lines. Selective cementation leads to production of pure silver, pure gold and, in two other steps, a palladium/platinum cementate and a raw selenium cementate. Any silver and gold powder that arises is cast into silver and gold granules in crucible furnaces and sold. The palladium/platinum cementate and raw selenium are sold as raw products.

Any process sewage that occurs in the production lines of the nickel sulphate plant, precious metal plant and oxychloride plant, as well as lab sewage, is cleaned so that the sewage limits prescribed by authorities are safely respected.

For this, the sewage is subjected to a two-stage precipitation process in which its metals are sulphidically precipitated and separated. Sulphidic precipitation was selected because the metal sulphides formed are much less soluble than, for example, the corresponding hydroxides. Waste water is subsequently neutralised before release. The sewage cleaning plant is designed for 150 m³/d sewage and works continually 24 hours a day.

Most of the operations of Plant 2113 are carried out in closed vessels, resulting in low exhaust airflows, which are treated in dedicated scrubbers. The off-gas from the refinery reactors and the pyrometallurgical operations is treated by alkaline scrubbing. From part of the flow, dioxins are removed by active coal filtration.

Table 7.24: Emissions in PM Plant 2113

Abatement technique	Pollutant	Values obtained	Unit	Method to obtain data	Type of average
			mg/Nm ³		
Alkaline scrubber (for the total exhaust gas of PGM refinery)	NO _x as NO ₂	Minimum	109	Periodic monitoring (4 times a year)	Average over the sampling period
		Average	193		
		Maximum	254		
	HCl	Minimum	< 0.04	Periodic monitoring (3 times a year)	
		Average	0.52		
		Maximum	1.12		
	Cl ₂	Minimum	< 0.04	Periodic monitoring (4 times a year)	
		Average	0.25		
		Maximum	0.45		
Active coal filter (for part of the flow)	PCDD/F	Minimum	0.0046 ng I- TEQ/Nm ³	Periodic monitoring (3 times a year)	
		Average	0.0056 ng I- TEQ/Nm ³		
		Maximum	0.0074 ng I- TEQ/Nm ³		
Bag filters and scrubber (for the combined emission point of silver refinery)	Dust	Minimum	0.14	Periodic monitoring (3 times a year)	
		Average	0.30		
		Maximum	0.45		
	NO _x as NO ₂	Minimum	8	Periodic monitoring (4 times a year)	
		Average	35		
		Maximum	60		

Source: [378, Industrial NGOs 2012]

All operations and off-gas treatment at this plant are completely automated. The total off-gas of the PGM refinery is 12 100 Nm³/h with 90th percentile concentrations of 0.98 mg/Nm³ for hydrochloric acid (HCl), 251 mg/Nm³ for NO_x, 0.43 mg/Nm³ for chlorine (Cl₂) and 0.0069 ng I-TEQ/Nm³ for dioxins.

The total off-gas of the silver refinery has a flow rate of 22 600 Nm³/h, with 90th percentile concentrations of 0.42 mg/Nm³ for dust and 59 mg/Nm³ for NO_x.

Plant 113 is predominantly involved in the production of silver salts. This involves dissolving high-purity silver bullion and also high-silver-bearing wastes from very specific industries. The monitored emission results can be found in Table 7.25.

Table 7.25: Emissions from scrubbing processes in PM Plant 113

Abatement technique	Values obtained	NO _x	Method to obtain data	Type of average
		ppm		
Wet scrubber and oxygen injection	Minimum	0.4	Continuous monitoring	Hourly
	Average	17		
	Maximum	78		

Source: [378, Industrial NGOs 2012]

In Table 7.26, Plant 112 reports the emissions for a combined gold and PGM refinery and a combined silver and PGM refinery.

Table 7.26: Emissions from scrubbing processes in PM Plant 112

Abatement technique	Pollutant	Values obtained	Unit	Method to obtain data	Type of average
			mg/Nm ³		
Alkaline scrubber (six columns with alkaline solution and hydrogen peroxide), for the combined emission point of a gold and PGM refinery	NO _x as NO ₂	Average	138	Periodic monitoring (11 times per year)	Average over the sampling period
		HCl	Average		
	Maximum		2.0		
	Cl ₂	Average	0.1		
		Maximum	2.0		
	SO _x	Average	0.1		
		Maximum	2.0		
	Alkaline scrubber (four chambers, three with nitric acid and one with alkaline solution), for the combined emission point of a silver and PGM refinery	NO _x as NO ₂	Average		
HCl			Average	6.0	
		Maximum	11.8		
Cl ₂		Average	0.9		
		Maximum	2.4		
SO _x		Average	0.6		
		Maximum	0.9		
<i>Source: [378, Industrial NGOs 2012]</i>					

Cross-media effects

- Requires reagents and other raw materials (e.g. caustic soda) as a scrubbing medium; some of these raw materials can however be recovered from on-site processes, resulting in the production of certain acid and alkali solutions and hence the reduction or minimisation of the use of fresh reagents instead.
- Increase in energy use to operate scrubbers and extraction/ventilation and control systems.
- Increase in water use to wash vessels, tanks and other reaction equipment after use.
- Generation of waste water effluents containing process run-off, spills and spent scrubbing liquids.

Technical considerations relevant to applicability

The techniques described are applicable for new installations but would require a major upgrade of existing installations.

Economics

No information provided.

Driving force for implementation

The main driving force for the implementation is the prevention and reduction of emissions to comply with legal requirements, as well as to minimise the loss of valuable (precious) metals and to save and recover raw materials containing PM and other valuable metals.

Example plants

- Containment measures: Plants 113, 205, 221, and 2113, among others.
- Sulphuric acid scrubber: Plants 221, 318, 13515, and 2113, among others.
- Alkaline scrubber: Plants 112, 113, 205, 221, 318, and 2113, among others.

- NO_x scrubber: Plants 113, 205, 221, 318, and 2113, among others.

Reference literature

[404, EPMF 2012]

7.3.6 Techniques to prevent and reduce emissions from PM incineration, calcining and drying operations

Description

The techniques to consider are the following:

- Connecting all calcining furnaces, incinerators and drying ovens to a ductwork system extracting process exhaust gases.
- Water scrubbing followed by caustic (alkaline) scrubbing (see Section 2.12.5.2.2). Water scrubbing can be used to absorb gases such as hydrochloric acid vapour, ammonium chloride and chlorine. Caustic (alkaline) scrubbing can be added to treat the gas stream not abated by the water scrubbing.
- Control systems, such as having the entire scrubber plant on a priority electricity circuit which is served by a back-up generator in the event of a power failure and operating start-up and shutdown, spent acid disposal and fresh acid make-up of scrubbers via an automated control system.
- Afterburner (see Section 2.12.5.2.1), cyclone (see Section 2.12.5.1.3), gas cooler, bag filter (see Section 2.12.5.1.4) and active coal adsorber (see Section 2.12.5.5).

Technical description

One of the most environmentally significant operations in PM processing with respect to gaseous emissions is the calcination of pure salts and blacks to metals, and especially the salts (of platinum, ruthenium and iridium) whose decomposition products include hydrochloric acid vapour, ammonium chloride and chlorine. Furthermore, these gases are produced at high temperatures (around 350–900 °C) which presents a further challenge for their handling and scrubbing. Hence, 'pure salts' calcination furnaces are normally connected to a dedicated 'pure salts' scrubber and the gases from this scrubber are directed to the caustic (alkaline) scrubber. The 'pure salts' scrubber comprises two stages of water scrubbing to quench (cool) the gases, and to absorb the ammonium chloride and hydrochloric acid; whilst chlorine and any residual acid not scrubbed by the water are efficiently scrubbed in the subsequent alkaline scrubber.

A similar scrubber unit is provided to handle exhaust gases from the 'impure salts' calcining furnaces, incinerators and drying ovens where similar temperatures are concerned. The gaseous products of these operations are usually much less significant than those from the ignition of platinum salt but include low concentrations of hydrochloric acid and possibly traces of other acidic gases such as sulphur, selenium dioxide and NO_x. As with the 'pure salts' operation, the gases leaving the 'impure salts' scrubber are routed via an alkaline scrubber before being discharged to atmosphere via a stack.

The scrubbing efficiency for these 'pure salts' and 'impure salts' units can be > 99 % prior to the alkaline scrubber. It is normal practice to have the entire scrubber plant on a priority electricity circuit, which is served by a back-up generator in the event of a power failure.

Normal operations including start-up and shutdown, spent acid disposal and fresh acid make-up are carried out via an automated control system (PLC or DCS). All process variables are relayed to the local control panel and to the central control room, where applicable.

Achieved environmental benefits

- Reduction of emissions to air.

- Recycling of recovered acid; the spent scrubbing liquid from the 'pure salts' and 'impure salts' scrubber units (dilute hydrochloric acid) is recycled and used as make-up acid in other refining operations, including in the waste liquor and effluent treatment plant.

Environmental performance and operational data

The gases from the 'pure salts' and 'impure salts' scrubber units in Plant 221 are fed to a caustic scrubber before being released to atmosphere. Typical emissions data are given in Section 7.3.5.

Plant 112 reported data for sweep incineration. An afterburner was used to abate PAH and especially PCDD/F. Before entering the bag filter, the exhaust gas had to be cooled down, so as not to exceed the tissue temperature limit. The very last stage of the treatment is the active coal adsorber, in order to remove mercury and the last traces of PCDD/F.

Table 7.27: Emissions from sweep incineration in PM Plant 112

	Abatement technique	Flow Nm ³ /h	Pollutant	Values	Unit	Method to obtain data	Type of average				
					mg/Nm ³						
Plant 112	Afterburner, cyclone, gas cooler, bag filter, active coal adsorber	3983	Dust	Minimum	0.10	Periodic monitoring (18 times per year)	Over the sampling period				
				Average	0.60						
				Maximum	1.95						
			SO ₂	Minimum	0.462						
				Average	2.3						
				Maximum	7.1						
			HCl	Minimum	0.46						
				Average	1.29						
				Maximum	3.60						
			HF	Minimum	< 0.5						
				Average	0.53						
				Maximum	< 0.6						
			PAH	Minimum	< 0.00002						
				Average	< 0.00002						
				Maximum	< 0.00002						
			PCDD/F	Minimum	0.028 ng I-TEQ/Nm ³			Periodic monitoring (3 times a year)			
				Average	0.059 ng I-TEQ/Nm ³						
				Maximum	0.083 ng I-TEQ/Nm ³						
			NO _x	Minimum	104			Continuous monitoring	Half-hourly		
				Average	202						
				Maximum	435						
			CO	Minimum	6						
				Average	15						
				Maximum	15						
			Total C	Minimum	< 2						
				Average	< 5						
				Maximum	< 5						
			Cd	Minimum	0.0001					Periodic monitoring (18 times per year)	Over the sampling period
				Average	0.0004						
				Maximum	0.0017						
			Tl	Minimum	0.0005						
				Average	0.0009						
				Maximum	0.0012						
Hg	Minimum	0.0016									
	Average	0.0028									
	Maximum	0.0037									
Sb	Minimum	0.0016									
	Average	0.0028									
	Maximum	0.0037									
As	Minimum	0.0005									
	Average	0.0009									

				Maximum	0.0012		
			Pb	Minimum	0.0011		
				Average	0.0023		
				Maximum	0.0048		
				Minimum	0.0022		
			Cr	Average	0.0041		
				Maximum	0.0069		
				Minimum	0.0002		
			Co	Average	0.0004		
				Maximum	0.0005		
				Minimum	0.0033		
			Cu	Average	0.0116		
				Maximum	0.0273		
				Minimum	0.0022		
			Mn	Average	0.0067		
				Maximum	0.0202		
				Minimum	0.0022		
			Ni	Average	0.0038		
				Maximum	0.0049		
				Minimum	0.0005		
			V	Average	0.0009		
				Maximum	0.0012		
				Minimum	0.0044		
			Sn	Average	0.0074		
				Maximum	0.0098		
				Minimum	0.0044		
<i>Source:</i> [378, Industrial NGOs 2012]							

Plant 102 reported data for its spent catalyst incinerator, as shown in Table 7.28.

Table 7.28: Emissions from spent catalyst incineration in PM Plant 102

	Abatement technique	Flow	Pollutant	Values obtained	Unit	Method to obtain data	Type of average
		Nm ³ /h			mg/Nm ³		
Plant 102	Bag filter		Dust	Average	9.2	Continuous monitoring	Daily average
	Caustic scrubber		NO _x	Maximum	88.1	Continuous monitoring	
			Ag	Average	0.14	Periodic monitoring	Average over the sampling period
	Afterburner		TVOC	Maximum	11.4	Continuous monitoring	Daily average
			CO	Maximum	67.5		
			PCDD/F	Average	0.0008 ng I-TEQ/Nm ³	Periodic monitoring (twice a year)	Average over the sampling period

Source: [378, Industrial NGOs 2012]

Cross-media effects

- Requires reagents and other raw materials (e.g. caustic soda) as the scrubbing medium; some of these raw materials can however be recovered from on-site processes, resulting in the production of certain acid and alkali solutions and hence the reduction or minimisation of the use of fresh reagents instead.
- Increase in energy use to operate extraction, scrubber and control systems.

Technical considerations relevant to applicability

This type of wet scrubber is applicable for new installations and major upgrades of existing installations.

Economics

No information provided.

Driving force for implementation

- Reduction of emissions.
- Environmental regulation requirements.
- To minimise the loss of valuable (precious) metals and to save and recover raw materials containing PM and other valuable metals.

Example plants

Plants 102, 112, 121, 205, 221 and 318, among others.

Reference literature

[378, Industrial NGOs 2012]

7.3.7 Techniques to prevent, treat and release or recover waste liquors from PM refining operations

Description

Techniques to prevent and treat waste liquors before release or recovery include:

- dedicated bunded storage tanks to hold process end liquors;
- chemical/metal reduction, precipitation or hydrolysis to treat process end liquors;
- scrubber system containing sulphuric or hydrochloric acid (it is possible to recycle ammonium chloride back into the refining process for a more sustainable operation) (see Section 2.12.5.2.2);
- ion exchange column containing a scavenging chelating resin to recover traces of soluble (precious) metals in the resulting liquor;
- for reactions generating hydrogen, dilution with large volumes of air to avoid explosive mixtures;
- use of ultrafine candle filters to (re)filter reaction filtrates before transfer to storage tank.

Technical description

PM refineries aim to minimise any release of metals to the sewer system and other watercourses. Therefore the effluent management system collects run-off from processes, process spills, maintenance, etc. The process end liquors are held in dedicated storage tanks prior to treatment. These tanks are all bunded so that any leak or spillage can be recovered without risk of release to the environment. The process end liquors have usually been treated by a combination of chemical/metal reduction, chemical precipitation and/or hydrolysis or ion exchange. Certain liquors, e.g. ammonia-bearing effluent streams, are segregated for ammonia stripping prior to reduction cementation and chemical precipitation treatment to remove ammoniated complexed species in solution. In some cases, these liquors can be discharged directly to the sewer if the analysis of the solution is within the limits set by the local regulator. In a few cases, the liquor being discharged to the sewer is also passed through an ion exchange column containing a scavenging chelating resin which extracts the last traces of soluble silver and other precious metals. When exhausted, the ion exchange resin is recycled to recover silver and precious metals.

PM refineries should have procedures in place for senior personnel to check and sign off analytical data before any liquor is discharged to the sewer or another watercourse (e.g. marine estuary). If the analysis of the waste liquor is above the discharge limits then it will be reprocessed. The final check on effluent discharged to the sewer, which is normally a mixture of process liquors, boiler water, cooling water and rainwater, is carried out just prior to it entering the public sewer or another watercourse. In addition to constant monitoring of the pH of the liquor, the effluent is continuously sampled using dedicated equipment, producing a composite sample. This composite sample is normally analysed for metal content on a daily basis to ensure the consent to discharge is being achieved.

For those liquors treated by chemical/metal reduction, electrochemical reduction, chemical precipitation or hydrolysis and ion exchange (or a combination of these processes), a suitable batch is transferred to a mixing tank where it is sampled and assayed, and its acidity adjusted up or down as appropriate (using hydrochloric acid or caustic soda solution). In certain cases, the initial alkaline solution is steam-distilled to remove ammonia prior to the treatment process and the ammonia gas is collected in a dedicated ammonia scrubber (see Section 7.3.5). The mixed solution is then transferred into a stirred tank and treated using the appropriate method. When the liquor is treated with iron metal (recycled scrap iron is often used when available), zinc or a chemical reductant, it reduces the PM and base metal from the solution as a 'reduction residue'. The iron and zinc reductions generate hydrogen and, to eliminate the risk of forming explosive hydrogen-air mixtures, large volumes of air are drawn across the surface of these reactions and vented unabated through stacks. Careful control of acidity and temperature not only controls hydrogen generation but also ensures minimal release of hydrogen chloride to air.

When the treatment process is completed (no PM in solution), the resulting mixture is filtered. The residue is recycled to the refining operation, either by direct hydrometallurgical processing or, where lower grade, by calcination and smelting operations. The PM-free filtrate which is normally the most significant source of aqueous effluent produced at the refinery is refiltered through a series of ultrafine candle filters and transferred to a storage tank. The solution is then mixed, sampled and analysed for PMs, base metals and ammonia/ammonium content. If the liquors do not meet the required discharge criteria, they are usually collected by a licensed contractor using road tankers and taken to their site for processing. The contractor mixes the refinery liquors along with those from other industrial sources, and precipitates them to produce an inert filter cake which is disposed of at a landfill site. In some EU Member States, landfilling is not an accepted practice and the residues have to be reprocessed to recover any base metals.

Achieved environmental benefits

- Reduction of emissions to water.
- Maximising the recycling of PM and base metal residues returned to refining operations, whilst ensuring that there are no uncontrolled releases of process liquors to drains, soil or other watercourses.

Environmental performance and operational data

Discharge to the sewer from Plant 221 (see description of Plant 221 in Sections 7.3.1, 7.3.2, 7.3.5 and 7.3.6) is shown in Table 7.29. The pH of the liquor is required to be in the range of 6 to 11, and is normally around 9. Discharge volumes would typically be 40 m³/d. The sewage treatment plant (STP) receiving this liquor has a maximum daily discharge volume of 1 344 000 m³/d.

Table 7.29: Emissions to water from PM Plant 221

Abatement technique	Metal	Concentration	Method to obtain data	Type of average
		µg/l		
Hydrolysis, followed by precipitation, filtration and ion exchange, then mixing with boiler water, cooling water and rainwater, etc. before discharge to drain/sewer	Arsenic	4.0	Continuous composite sampling	Daily average
	Cadmium	< 10		
	Chromium	< 100		
	Copper	175		
	Lead	< 1000		
	Mercury	0.050		
	Nickel	< 1000		
	Silver	500		
Zinc	325			

Source: [378, Industrial NGOs 2012]

The final filtrate liquor is managed by a licensed contractor (to landfill), and its typical metal concentration would be as indicated in Table 7.30.

Table 7.30: Concentration of the final filtrate liquor generated in PM Plant 221

Metal	Concentration
	µg/l
Arsenic	25
Copper	475
Lead	200
Nickel	140
Iron	2000
Zinc	600

Source: [378, Industrial NGOs 2012]

Volumes would be in the range of 15–40 m³ per day.

Plant 113 is predominantly involved in the production of silver salts. This involves dissolving high-purity silver bullion and also high-silver-bearing wastes from very specific industries. Emissions to water are given in Table 7.31.

Table 7.31: Emissions to water from PM Plant 113

Abatement technique	Metal	Concentration		Method to obtain data	Type of average
		mg/l			
		Avg.	Max.		
Settlement pits, precipitation and reduction reactions, pH adjustment	Silver	0.363	2	Continuous composite sampling	Daily average

Source: [378, Industrial NGOs 2012]

In Plant 117, spent electrolyte from silver electrolysis is first cemented with copper powder. Residue silver in gold production is precipitated in the form of silver chloride and next cemented with iron dust. After filtration both solutions are collected in tanks, to which the filtrate from selenium filtration is also directed. Then the mixed waste water is neutralised with lime milk in a local waste water treatment plant. After filtration the slime is returned on site to the copper smelting plant, while the filtered solution is discharged into the copper smelter's acid waste water sewer for final neutralisation and coagulation, to be finally discharged into the river.

Table 7.32: Emissions to water from PM Plant 117

Abatement technique	Metal	Concentration after local pretreatment			Concentration after final treatment before discharge		
		mg/l			mg/l		
Pretreatment with lime milk		Minimum	Average	Maximum	Minimum	Average	Maximum
	Cu	< 1	< 1	6	0.024	0.031	0.357
	Ag	< 5	< 5	< 5	< 0.02	< 0.02	< 0.02
	As	1	21.35	88	0.003	0.022	0.098
	Pb	< 1	< 1	6	0.071	0.148	0.22
	Se	1	22.25	202	NA	NA	NA

Source: [378, Industrial NGOs 2012]

Table 7.33: Emissions to water from PM Plant 1019

Abatement technique	Metal	Concentration			Method to obtain data	Type of average
		mg/l				
		Minimum	Average	Maximum		
Iron cementation or hydrazine reduction & filtration of PGM liquors, pH adjustment with lime & filtration (press)	Arsenic	0	0	0.11	Continuous composite sampling	Daily average
	Cadmium	0	0	0		
	Chromium	0	0	0.06		
	Copper	0	0.04	0.31		
	Lead	0	0	0.05		
	Mercury	0.0002	0.0003	0.0008		Weekly average
	Nickel	0	0.08	0.46		Daily average
	Silver	0	0.01	0.09		
	Zinc	0	0.01	0.28		
	Thallium	0.0001	0.0001	0.00015		
	Cobalt	0	0	0.01		
	Tin	0	0	0.17		
	Vanadium	0	0	0.12		
	Bismuth	0	0.01	0.18		
	Platinum	0	0	0.19		
	Ruthenium	0	0	0.07		
	Iridium	0	0.01	0.18		
	Gold	0	0	0.09		
	Selenium	0	0	0.17		
	Iron	0	0.27	3.54		
	Cl ⁻	0	5850	NR		
	NH ₃	0	4	48		
	COD	190	595	1300		
SO ₄	30	140	700			
Suspended solids	20	82	270			
Sulphides	< 1	< 1	< 1			

NB: NR = Not representative.
Source: [378, Industrial NGOs 2012]

Pretreated waste water from the PM plant is discharged to the acid waste water sewer of the copper smelter. The merged stream of the PM plant's and the copper smelter's waste water is transported by sewerage system to the central waste water treatment plant of the copper smelter, where, after neutralisation and coagulation, it is discharged into the river. Pretreated waste water from PM plants constitute about 2 % of the acid waste water sewer stream directed to the waste water treatment plant.

Table 7.34: Emissions to water from PM Plant 205

Abatement technique	Metal	Concentration			Method to obtain data	Type of average
		mg/l				
		Minimum	Average	Maximum		
Addition of Zn powder and resins filtration (for waste water from Au refining). Addition of lime milk, filtering in a filter press and neutralising with HCl (for all waste water treated)	Arsenic	< 0.005	< 0.005	< 0.005	Continuous composite sampling	Daily average
	Cadmium	0.05	0.05	0.05		
	Chromium	< 0.3	< 0.3	< 0.3		
	Copper	< 0.1	< 0.1	< 0.1		
	Lead	< 0.25	< 0.25	0.25		
	Nickel	< 0.2	< 0.2	< 0.2		
	Zinc	< 0.3	< 0.3	< 0.3		
	Tin	< 1	< 1	< 1		
	Iron	< 0.2	< 0.2	< 0.2		
AOX	0.1	0.12	0.15			

Source: [404, EPMF 2012.]

Cross-media effects

- Requires reagents and other raw materials (e.g. caustic soda, resin) to recover metals; some of these raw materials can however be recovered from on-site processes, resulting in the production of certain acid and alkali solutions and hence the reduction or minimisation of the use of fresh reagents instead.
- Increase in energy use to operate the scrubber, monitoring and control systems.
- Generation of waste streams that enter the sewer or are landfilled.

Technical considerations relevant to applicability

The techniques described are applicable for new installations, but would require a major upgrade of existing installations, assuming there is space available within the effluent processing areas.

Reliability issues could affect ion exchange and ultrafine filtration (e.g. membranes) with some sites' effluents. Trials show that resins may become poisoned by dissolved species which are a by-product of the process and any treatment after lime/caustic precipitation would suffer from scaling issues, making these techniques not applicable at the tail end of the process.

Economics

No information provided.

Driving force for implementation

- Prevention and reduction of dust emissions.
- To minimise the loss of valuable (precious) metals and to save and recover raw materials containing PM and other valuable metals.

Example plants

Plants 112, 113, 117, 205, 221, 1019 and 318, among others.

Reference literature

[404, EPMF 2012.]

7.3.8 Techniques to prevent and reduce emissions from the melting of final metal products in PM refining

Description

The techniques to consider are:

- enclosed furnace with negative pressure (see Section 2.12.4);
- appropriate housing, enclosures, capture hoods with efficient extraction/ventilation (see Section 2.12.4);
- bag filters (see Section 2.12.5.1.4).

In some sites, depending on their size and overall organisation (individual or annexed to other metal refining operations for instance), the recovery and treatment of dust generated from pretreatment and handling operations are carried out in a such a manner that dust (and fumes) generated by smelting and other dust-generating operations is captured, treated and controlled in a centralised manner. This explains the similarities between techniques described in Sections 7.3.1, 7.3.2, 7.3.3 and 7.3.8.

Technical description

The melting of final products such as silver crystals, gold cathodes and gold precipitate takes place in small batch-wise operated melting furnaces. Electric induction crucible furnaces or gas/oil-fired furnaces can be used. Molten metal is cast in different shapes (bars, ingots) or granulated. Induction furnaces minimise the production of combustion gases and the associated size of the abatement plant.

Melting furnace exhaust gas and ventilation gas are cooled and dedusted in bag/micro-cassette filters.

Achieved environmental benefits

Prevention and reduction of dust emissions.

Environmental performance and operational data

At Plant 121, a natural-gas-heated furnace is used to melt silver crystals. Silver is granulated or cast in silver bars. An induction furnace is used to melt gold cathode or gold precipitate. Gold is cast in bars of different weights. The casting of anodes for gold electrolysis also takes place. Furnaces are enclosed. The casting area is underneath a capture hood. Off-gas and secondary gases are cleaned in bag/micro-cassette filters. The off-gas has a flow rate of up to 4000 Nm³/h; measurements are performed once a year (three 30-minute measurements) and measured dust levels are below 1 mg/Nm³.

In Plant 2426, the Small Pan process which is used for final refining may also be used to remelt an out-of-specification product (e.g. one rejected for an out-of-specification physical appearance). Remelted material will typically consist of silver bars. The bag filter has an efficiency of > 99.99 % and the extraction rate capacity is 160 000 m³/h, which serves all the silver circuit processes.

Cross-media effects

Increase in energy use to operate extraction, ventilation, and dedusting systems.

Technical considerations relevant to applicability

Generally applicable.

Economics

Driving force for implementation

- Prevention and reduction of dust emissions.

- To minimise the loss of valuable (precious) metals and to save and recover raw materials containing PM and other valuable metals.

Example plants

Plants 112, 117, 121, 221, 318, 2113 and 2426, among others.

Reference literature

[404, EPMF 2012]

7.4 Emerging techniques

The 'J' process is not operated in Europe but can operate with a lower inventory of gold than other gold refining processes. It uses a regenerable iodine solution to dissolve impure gold (< 99.5 %). The gold is reduced by potassium hydroxide, separated, washed and dried to a powder that contains 99.995 % gold. Liquor from the reduction stage is fed to an electrolytic cell where soluble impurities and any unreduced gold iodide are deposited on the cathode and removed for recovery in a precious metals circuit. The solution is then transferred to an electrolytic diaphragm cell fitted with inert electrodes. Iodine solution produced in the anode compartment and KOH solution produced in the cathode compartment are recycled [5, B R Lerwill et al. 1993].

A process has been designed to treat a pyrite concentrate that contains microscopic gold particles (< 1 μm) to produce a gold Doré, a lead-silver concentrate and a zinc concentrate [210, Greek State 1999]. The metallurgical flowsheet is shown below in Figure 7.4.

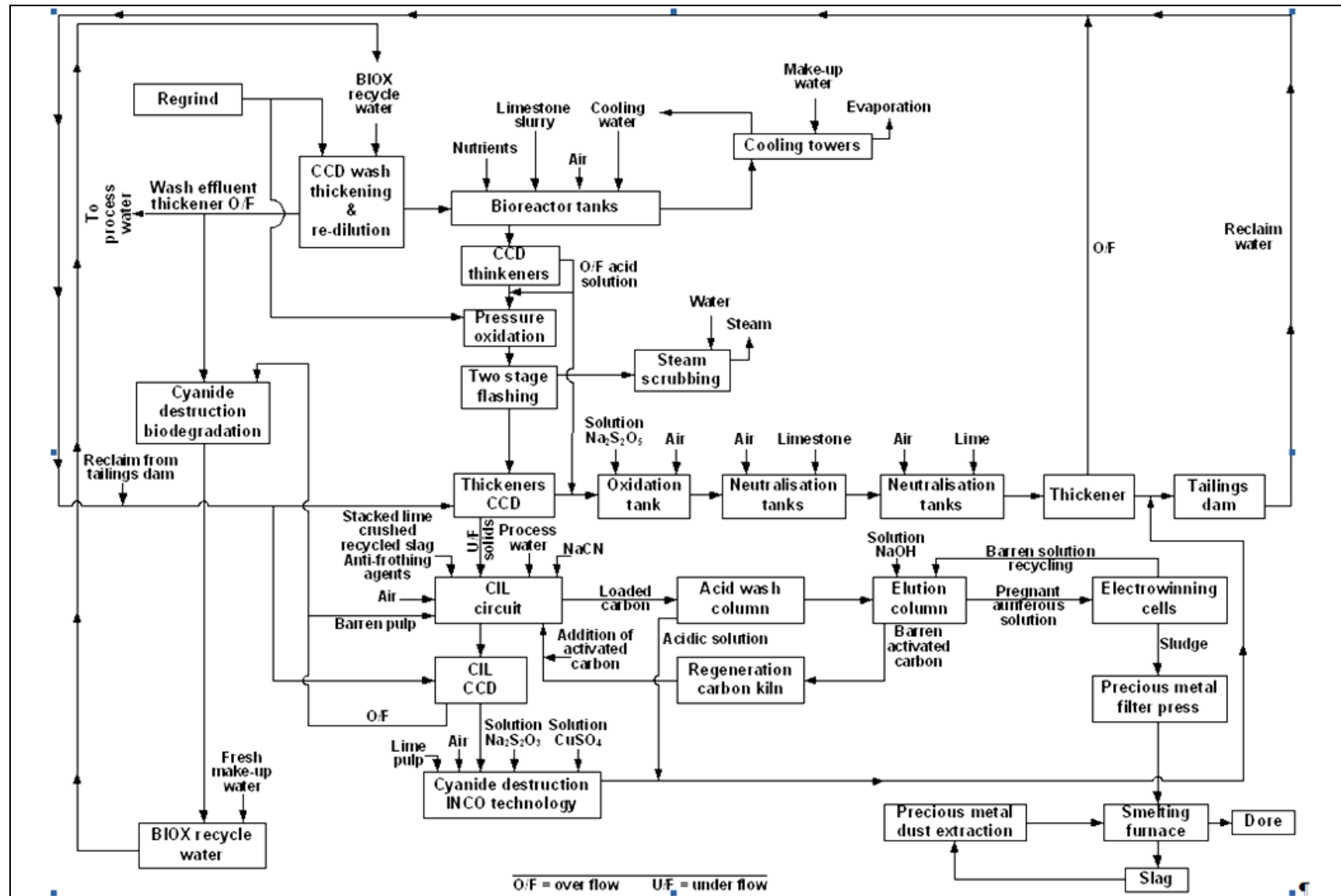

Figure 7.4: Metallurgical process flowsheet

8 PROCESSES TO PRODUCE FERRO-ALLOYS

Ferro-alloys are mainly used as master alloys in the iron, foundry and steel industry, because it is the most economical way to introduce an alloying element into the steel melt. Besides this, special ferro-alloys are also needed for the production of aluminium alloys and as starting material in specific chemical reactions.

As an additive in steel production, ferro-alloys improve the properties, especially the tensile strength, wear and corrosion resistance. The effect of the improved properties of steel by using ferro-alloys as an alloying element depends more or less on the following influences [104, Ullmann's Encyclopedia 1996]:

- a change in the chemical composition of the steel;
- the removal or the tying up of harmful impurities such as oxygen, nitrogen, sulphur or hydrogen;
- a change in the nature of the solidification, for example, upon inoculation.

Depending on the raw material that is used (primary or secondary raw material), the production of ferro-alloys can be carried out as a primary or secondary process. The principal chemistry of both processes can be shown as follows:

Primary processes:

Oxidic metal ore + iron ore/scrap + reducing agent → ferro-alloy + reducing agent oxide + slag

Secondary processes:

Metal scrap + iron scrap → ferro-alloy

Primary ferro-alloys are principally produced either by the carbothermic or metallothermic reduction of oxidic ores or concentrates. The most important process is carbothermic reduction, in which carbon in the form of coke (metallurgical coke), coal or charcoal is normally used as a reducing agent. When a blast furnace is used, coke is also needed as an energy source. [255, VDI 2010].

Metallothermic reduction is mainly carried out with either silicon or aluminium as the reducing agent. The following chemical equations show the basic principles of the carbothermic and metallothermic production routes.

Carbothermic reduction: metal oxide + carbon → metal + carbon monoxide

Silicothermic reduction: metal oxide + silicon → metal + silicon oxide

Aluminothermic reduction: metal oxide + aluminium → metal + aluminium oxide

8.1 Applied processes and techniques

Depending on the production rate, ferro-alloys can be divided into two main categories: bulk alloys and special alloys. Bulk ferro-alloys (ferro-chrome, ferro-silicon, ferro-manganese, silico-manganese and ferro-nickel) account for about 90 % of the total production of ferro-alloys in the European Union.

Compared to bulk ferro-alloys, the production rate of special ferro-alloys is small. Special ferro-alloys (ferro-vanadium, ferro-molybdenum, ferro-tungsten, ferro-titanium, ferro-boron and ferro-niobium) are mostly used in the iron, steel and cast iron industries. Besides this, some special ferro-alloys are increasingly also used in other industry sectors, e.g. aluminium and chemical industries.

8.1.1 Ferro-chrome

Ferro-chrome, along with nickel (ferro-nickel), is the major alloying element in the production of stainless steel. Stainless steel is used in a variety of areas from cutlery to aircraft engine turbine blades.

The chromium content of ferro-chrome normally varies from 45 % to 75 % and it also contains various amounts of iron, carbon and other alloying elements. The use of ferro-chrome depends mainly on the carbon content. Ferro-chrome can therefore be classified as follows:

- high-carbon ferro-chrome (HC FeCr) with 2–12 % C (ferro-chrome carburé);
- medium-carbon ferro-chrome (MC FeCr) with 0.5–4 % C (ferro-chrome affiné);
- low-carbon ferro-chrome (LC FeCr) with 0.01–0.5 % C (ferro-chrome suraffiné).

8.1.1.1 Raw materials

The main raw material to produce ferro-chrome is chromite ore, which is a mineral that contains iron and chromium oxides. The ratio between Cr and Fe in the chromite ore determines the chromium content of the alloy produced, e.g. a high Cr to Fe ratio is advantageous for the production of a ferro-alloy with a high chromium content. Chromite ore is used in the form of hard or upgraded lump varieties, friable lumps or fine concentrate.

The reducibility of diverse ores is quite different. Generally speaking, for the production of FeCr, podiform ores are of a higher quality, resulting in a high-Cr alloy, while stratiform ores have a lower chromite content and a low Cr to Fe ratio, resulting in a charge chrome alloy. For this reason, podiform ores will most often give a chromium recovery in excess of 90 %, while for fine stratiform ores the recovery is below 70 % in conventional production routes. This is the case with South African ores. With the DC plasma process, recovery is reportedly above 90 %. This compensates for the higher consumption of electrical energy needed to increase the process temperature to achieve faster reduction. In the widely used technology of sintered pellets (grinding, pelletising and sintering) the increased reduction rate of the fine stratiform ores is based on increased reaction surface, the recovery with pellets being close to 87 %. For podiform ores, the recovery benefits of these alternative process routes will not be of the same magnitude.

Depending on the different production routes and the desired carbon content of the ferro-chrome, carbon or silicon is used as a reducing agent [255, VDI 2010]. For the production of HC FeCr, carbon is added to the process as a reducing agent in the form of metallurgical coke, coal or charcoal. Metallurgical coke is the most common reducing agent. It is important that a coke with a low phosphorus and sulphur content is used because 60–90 % of the phosphorus and 15–35 % of the sulphur is transferred into the metal. For the production of LC FeCr, ferro-silico-chromium and ferro-silicon are used in a silicothermic reduction as reducing agents and raw material. To achieve sufficient purity of the reducing agent (mainly coal), a coal washing

step may be carried out. This may be done by heavy media separation and takes place at coal mines or coal disposal points but not at the ferro-alloy plant.

For some processes, primary raw materials, like coke, or secondary raw materials need to be dried before they are used in the process. In some cases, coke drying is important for removing moisture, depending on the climate, snow and ice.

In order to achieve the right metal analysis, a good metal recovery and a satisfactory furnace operation, auxiliary materials such as quartzite, bauxite, corundum, lime and olivine can be added to the burden as fluxing agents.

8.1.1.2 Pretreatment techniques

Chromite is used as a raw material for the production of ferro-chrome in the form of lumpy ore, fines and concentrates, although mainly as fine concentrate (< 1 mm). To convert ore fines and concentrates to furnaceable material, they first need to be agglomerated by briquetting, pelletising and sintering, or sintering alone. Agglomeration is necessary to achieve good recoveries and also to give a permeable burden, which allows the gas from the reaction zone to escape [255, VDI 2010].

Green pellets are made by rolling fine, ground, moist ore with the addition of a binder and fine-grained coke breeze into balls in a rotary drum or on a disc. These are later sintered in a steel belt furnace to hard, porous pellets with constant physical and chemical properties. The steel belt sintering process consists of a multi-compartment oven through which the green pellets are carried on a perforated steel conveyor belt. Green pellets are dried in the drying compartment, by circulating gas from the last cooling compartment. In the preheating compartment, the temperature of the pellets is increased so that they are calcined and the carbon in the bed is ignited. Heating gas is taken from the second cooling compartment. In the sintering compartment, a sintering temperature of 1350–1450 °C is achieved. Heating gas, in addition to the energy from the burning of carbon and the oxidation of iron, is taken from the first cooling compartment. The front-end compartments are in a draught configuration, and cooling air is blown into the three cooling compartments from below. To control the temperature profile in the compartments, CO gas from smelting or natural gas is burnt in the burners located in the recycling gas duct of the preheating and sintering zones. Product pellets and circulating pellets are used as a bottom layer on the steel belt to protect it from excessively high temperatures. The steel belt sintering furnace is closed. The process is shown in Figure 8.1.

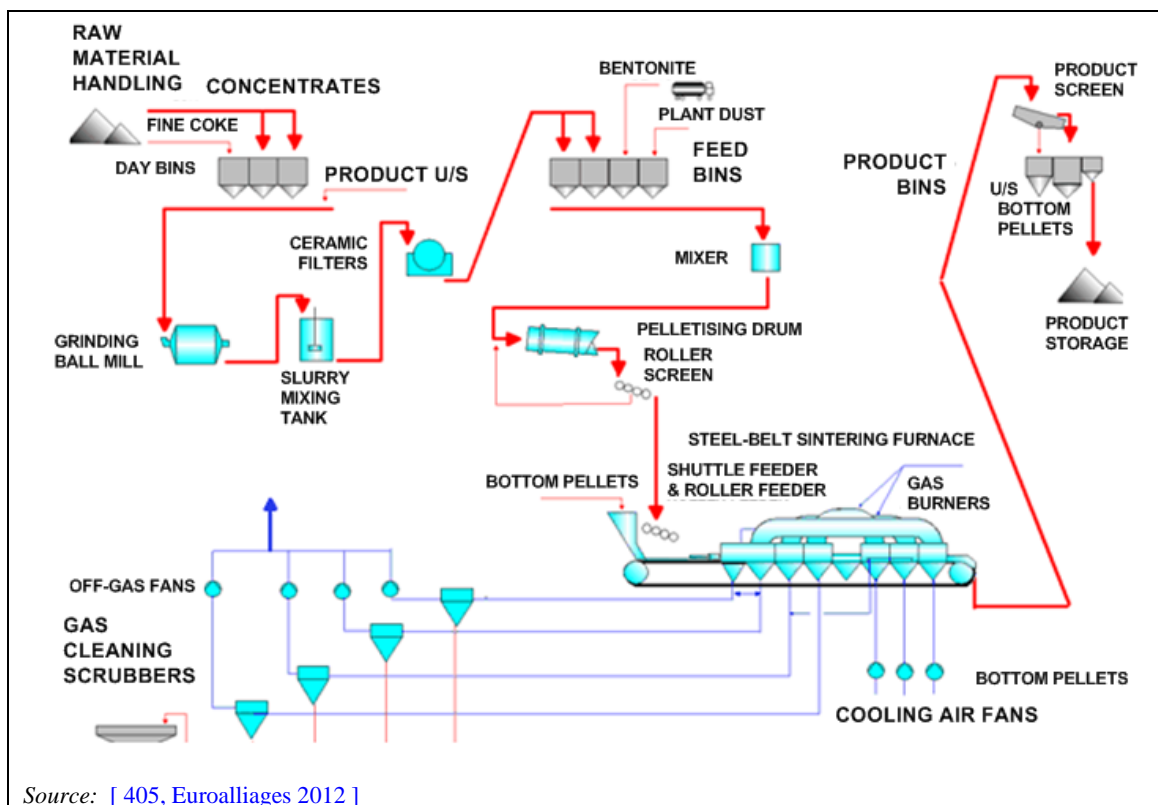

Source: [405, Euroalliages 2012]

Figure 8.1: Steel belt sintering process

Where thermal treatment (sintering) is involved, process off-gases must be cleaned in cascade scrubbers or fabric filters. For all the agglomeration processes, collected raw material dusts from these processes or from other raw material handling processes can be recycled. The external energy consumption in a steel belt sintering furnace is lower than in a shaft furnace and a grate furnace: energy consumption in a steel belt sintering furnace is 700–1400 MJ/t of pellets. In a Finnish plant applying this process, CO from the smelter is used as a fuel together with coke fines.

8.1.1.3 Production of ferro-chrome and silico-chromium

8.1.1.3.1 High-carbon ferro-chrome

High-carbon ferro-chrome (HC FeCr) is produced almost exclusively by the direct carbothermic reduction of chromite ore in three-phase submerged electric arc furnaces with continuous operation. The burden can be preheated in a shaft or rotary kiln using the CO gas from the smelting process. Pre-reduction in a rotary kiln is also possible. In both cases, the specific consumption of electrical energy will be reduced. Closed, semi-closed or open submerged electric arc furnaces including three-phase AC (alternating current) operation and single-phase DC (direct current) plasma arc furnaces are used. The DC arc furnace includes a single hollow graphite electrode. The building of open furnaces for ferro-chrome production is prohibited in many countries for environmental reasons. The formation of chromium(VI) in the dust is too high.

The submerged arc furnaces use Søderberg electrodes. The electrode may be formed by hot paste, briquettes, blocks or paste cylinders. The electrode paste is charged on top of the electrode in accordance with its consumption. The material is subject to increased heat as it moves downwards in the electrode column. It melts at about 80 °C and bakes at 500 °C. To control the smelting process, the furnace operation can be based on resistance or current control, so that the electrodes are lifted and lowered when necessary to keep the resistance or current

constant. A system of electrode sealing is needed to prevent air leakage into the furnace. As an alternative, another practice is commonly used where the electrode moves only during slipping and otherwise stands in place.

During the smelting process, the metal oxides are reduced by the coke, with metal carbides as the final product. The reduction produces large volumes of CO gas from the reaction zone under the electrode tips. In an open furnace, the CO gas is burnt at the surface of the furnace. Thus, the heating value of the CO-rich gas is wasted. Compared with an open furnace, the off-gas volume can be reduced in a closed sealed furnace by a factor of 50–75 and by a factor of 10–20 in the case of a semi-closed furnace. The investment costs for the off-gas cleaning systems for closed furnaces are much lower than for open furnaces. The cleaned CO gas can be used as fuel for preheating raw material, coke drying and similar processes, substituting oil or other fossil fuels. The heating value of the off-gas from semi-closed furnaces can be recovered in the form of steam or hot water.

Ferro-chrome and the slag are tapped off at regular intervals from tapholes near the bottom of the furnace. Slag and metal are tapped through the same tapholes using cascade tapping into the same metal vessel. The lower density slag will float to the top and eventually overflow through the ladle spout to the slag pot or via a secondary launder to a slag pit, granulating basin or other slag vessel. Bed casting and layer casting are the most frequently used methods for casting ferro-chrome because of the simplicity and the low costs of these methods. The cooled castings are crushed and screened on the product handling line to produce the commercial product lot specified by the customers. If possible, the molten ferro-chrome can also be transferred directly to an adjacent stainless steelmaking plant.

The slag can either be granulated with a high-pressure water jet or cast outdoors in layers, cooled, crushed and screened.

Below is a description of how the slag is directly granulated during tapping, where ferro-chrome is tapped into ladles. The overflow from the ladles flows along the slag launder to the granulation pond, where high-pressure water breaks the slag into small fractions and efficiently cools it down. Granulated slag is a very homogeneous product. The grain size is < 6 mm. Each granule is tight and partly crystalline. Typically the granulated slag includes three different phases: an amorphous glass phase, crystalline and zonal Fe-Mg-Cr-Al spinels, and metal drops. The granulation process is shown in Figure 8.2.

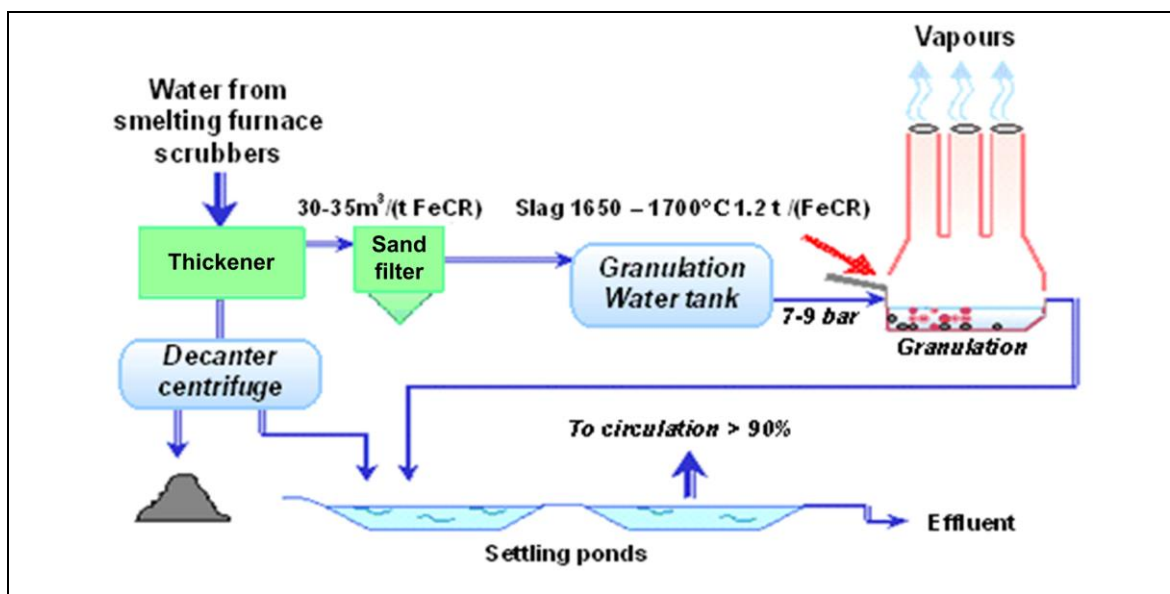

Figure 8.2: Slag granulation process

Cast slag that contains metal is also crushed and the metal content recovered by means of slag-metal separation [255, VDI 2010]. Recovered slag-free lump metal can be sold, while slag-contaminated metal and fines can be sold or recycled to the smelting process. Slag can also be treated by heavy media separation, magnetic separation or jigging. Both the granulated and the lump slag are reused as building and road construction material.

An example of a high-carbon ferro-chrome production process using a closed submerged electric arc furnace is shown in Figure 8.3.

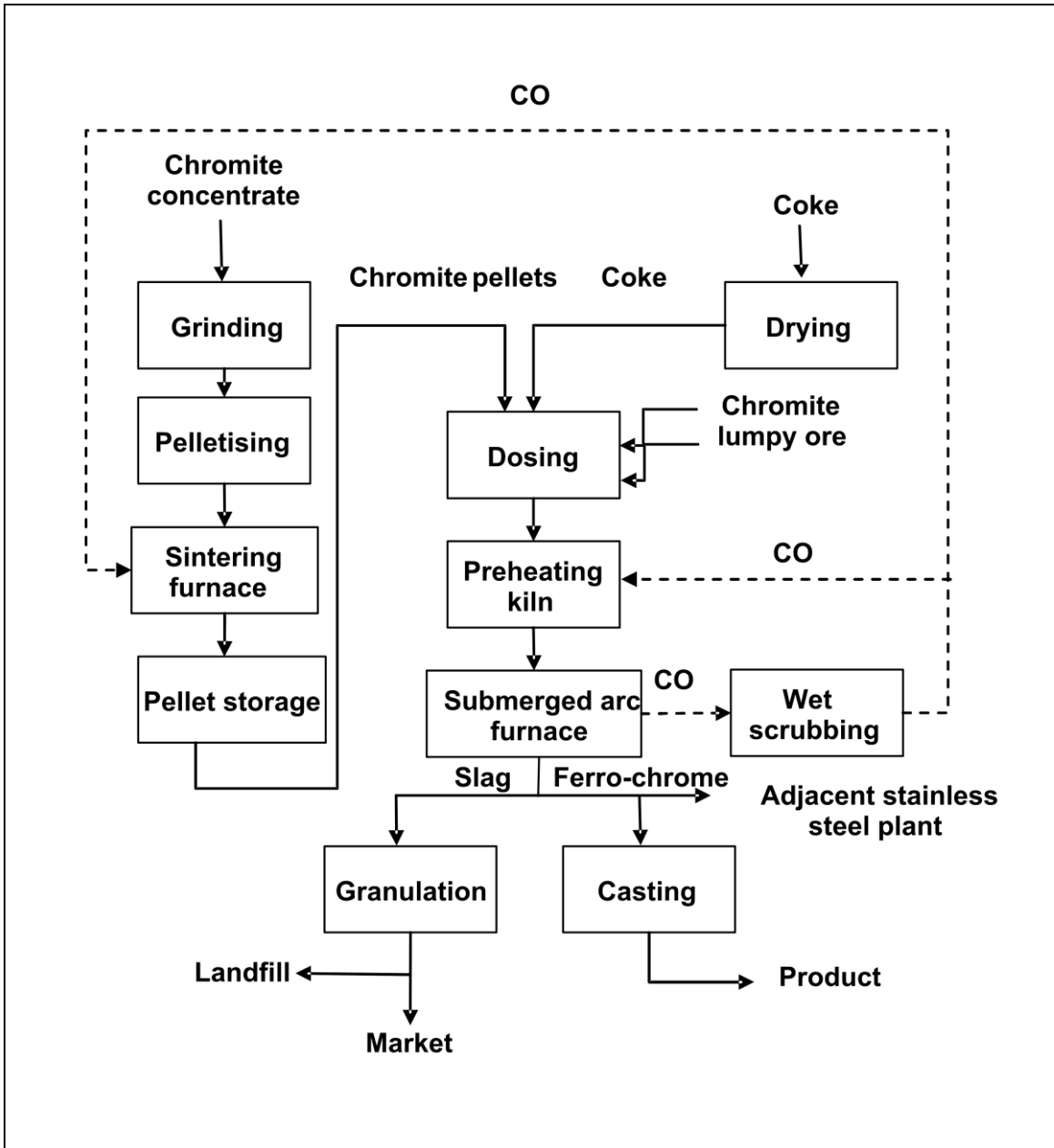

Figure 8.3: High-carbon ferro-chrome production using a closed submerged electric arc furnace

An example of a ferro-chrome production process using a semi-closed submerged electric arc furnace is shown in Figure 8.4.

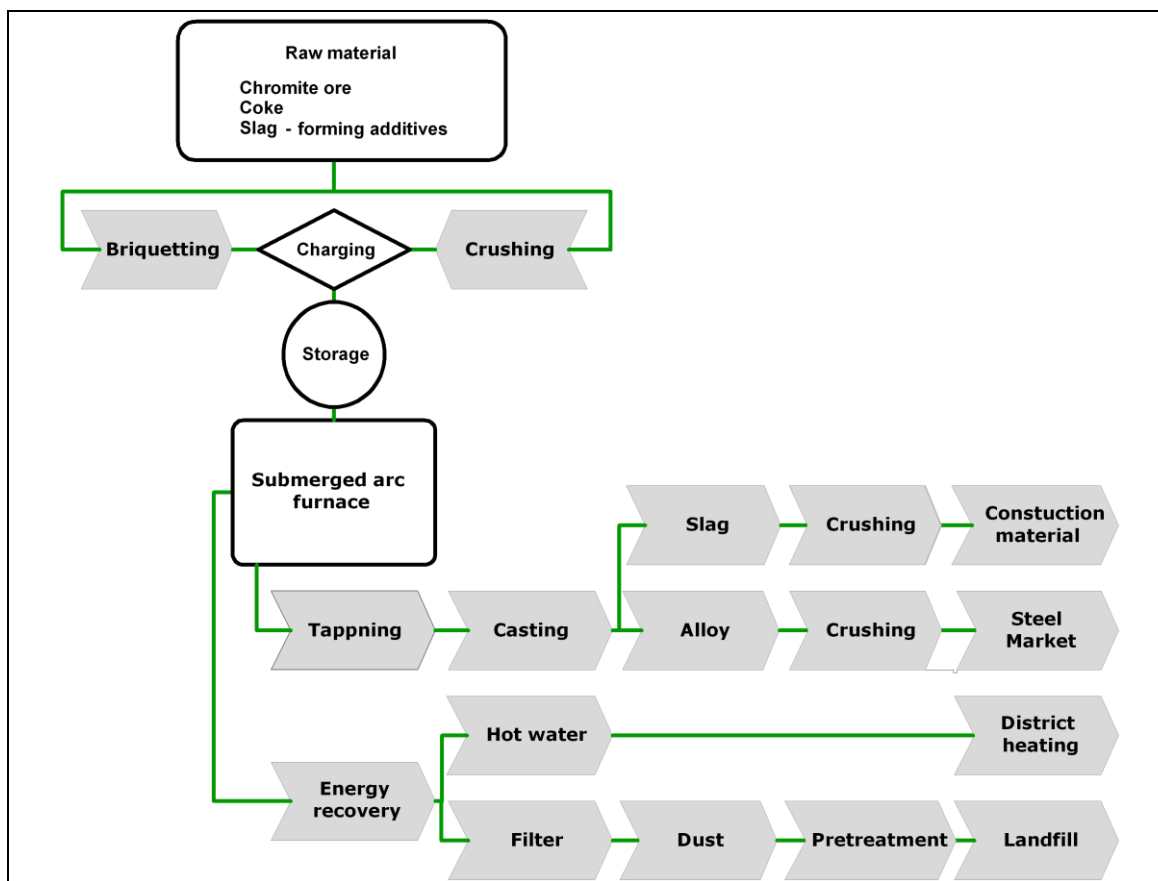

Figure 8.4: Ferro-chrome production using a semi-closed submerged arc furnace

8.1.1.3.2 Medium-carbon ferro-chrome

Medium-carbon ferro-chrome (MC FeCr) can be produced by the silicothermic reduction of chromite ore and concentrates, or by the decarburisation of HC FeCr in an oxygen-blown converter. The oxygen can be introduced in the molten metal from the top of the melt using water-cooled lances or by injection at the bottom of the converter. The bottom-blowing process has the advantage that a high decarburisation rate can be achieved together with a high chromium recovery. The high bath temperature in a bottom-blown converter affects the high decarburisation and chromium recovery rates.

The silicothermic route is more economical and therefore more suitable for producing MC FeCr. The reason may be the small MC FeCr demand compared with the high demand for HC FeCr together with the fact that low-carbon ferro-chrome can be produced by the same process as well.

8.1.1.3.3 Low-carbon ferro-chrome

In order to get the desired low carbon content in low-carbon ferro-chrome (LC FeCr), a carbothermic process cannot be used. The most commonly used processes are therefore metallothermic reductions known as the Duplex, Perrin or Simplex processes.

The only process used in the EU-28 to produce LC FeCr is the Duplex process. In this process, LC FeCr is produced by the silicothermic reduction of a lime-chromite slag. The slag smelting process takes place in a tiltable AC arc furnace with Söderberg electrodes. The furnace is operated at about 1750 °C. The liquid melt is tapped at regular intervals into a first reaction ladle. When SiCr, ore and lime are added to the ladle, the reacting mixture is converted into LC FeCr and an intermediate slag. During this process the ladle is covered by a smoke hood. About

70 % of the intermediate slag is transferred to a second reaction ladle, which is also covered by a fume collection hood. Adding Si, FeSi, sand and boric acid to the mixture produces a final slag and a metal. The metal is recycled back to the first ladle. A fabric filter cleans the off-gas of the furnace from both reaction ladles. The dust from the bag filter is recycled into the smelting furnace. The Perrin process is similar but uses two arc furnaces.

LC FeCr can also be produced by the Simplex process. In the Simplex process, HC FeCr is crushed in a ball mill in order to get a ferro-alloy powder. After briquetting the HC FeCr powder together with Cr_2O_3 and Fe_2O_3 , the mixture can be decarburised by annealing at about 1350 °C in a vacuum furnace.

8.1.1.3.4 Silico-chromium

Silico-chromium is also used as an alloying element in the steel industry. It can be produced in the same kind of three-phase submerged electric arc furnaces as used for HC FeCr production. The reduction of SiO_2 to Si is combined with the generation of huge amounts of CO gas. The high generation rate of CO makes it important to use a porous burden (e.g. gas coke), and a semi-closed or closed furnace with an appropriate energy recovery system.

8.1.2 Ferro-silicon and silicon alloys

Ferro-silicon, silicon metal and silico-calcium (CaSi) are used as additives in different industrial products. As an alloying element, ferro-silicon increases the strength of steel and is therefore used in steel that is needed to produce wire cords for tyres or ball bearings. Ferro-silicon is also used to remove dissolved oxygen from molten steel. High-purity FeSi is used to produce high-permeability steel for electric transformers. Silicon metal is important as an alloying element in aluminium and for the production of chemicals and electronic products. The major user of silico-calcium is the steel industry. The aforementioned metals can be classified by their silicon content as follows:

- ferro-silicon: silicon content of less than 96 %;
- silicon metal: silicon content of above 96 %;
- silico-calcium: silicon content of about 60–65 % and calcium content of 30–35 %.

8.1.2.1 Raw materials

The raw materials that are commonly used for the production of ferro-silicon, silicon metal and silico-calcium are listed in Table 8.1.

Table 8.1: Raw materials for the production of ferro-silicon, silicon metal and silico-calcium

Raw material	Ferro-silicon	Silicon metal	Silico-calcium
Quartz	X	X	X
Coke	X	NA	X
Petrol coke	NA	X	NA
Coal	X	X	X
Charcoal	X	X	NA
Woodchips	X	X	NA
Limestone	NA	X	X
Iron ore/steel scrap	X	NA	NA
Amorphous carbon	NA	X	NA
Graphite electrodes	NA	If a combined graphite/ Söderberg electrode is used	NA
Söderberg electrode paste	X	NA	X
NB: NA = Not applicable.			

In order to achieve good process results, the selection of the raw material is made based on strict quality requirements. The thermal strength of the quartzite for example is of special importance because it is connected to the gas permeability of the charge where too much fine-sized material may prevent gas flow. The carbon quality is important for the environmental performance of the process, because the coal and coke contain sulphur and trace elements which can be emitted into the environment [226, Nordic Report 2008]. If carbon contains mercury or other vaporous elements, they will evaporate in the process and will be emitted as part of the off-gas into the environment.

The generation of fines due to the free fall of different raw materials has been studied and is presented in Table 8.2 (repetitive falls may result in higher fines generation per fall). To avoid the generation of fines, excessive falls/drops and handling of the raw materials should be avoided. A more extensive literature study of how quartz handling generates fines has been done by Aasly et al. [337, K. Aasly 2008].

Table 8.2: Fines generation due to free fall

Fines generation	Coal	Coke	Quartz	Iron pellets
2 m fall	0.6 %	0.2 %	0.2 %	0.1 %
16 m fall	2.7 %	0.5 %	0.8 %	0.4 %

8.1.2.2 Production of ferro-silicon, silicon metal and silico-calcium

The different raw materials that are used for Si, FeSi and CaSi production are preferably stored on hard surfaces in order to prevent contamination. The reducing agents are stored outdoors or indoors, the latter to protect the material from humidity caused by rain. Some of the reducing agents can have self-igniting characteristics. In these cases, appropriate methods have to be implemented to avoid self-combustion, e.g. in charcoal or coal with a high volatile matter and woodchips content.

Ferro-silicon, silicon metal and silico-calcium are commonly produced in low-shaft three-phase submerged electric arc furnaces [255, VDI 2010]. The furnace can be of the open or semi-closed type. The furnace normally rotates in order to connect the reaction areas around each electrode tip to break down crust in between the electrodes. The rotation gives rise to some difficulties in obtaining good capture efficiency of the diffuse emissions at the taphole as the location of the taphole will rotate with the furnace. The raw material is fed from storage bins above the furnace, through feeding tubes. In small furnaces, the raw material can also be fed using stocking cars.

The smelting of silicon metal and silicon alloys normally takes place in open or semi-closed furnaces. The open furnaces are commonly built with movable curtains or gates around the furnace hood to secure access for maintenance and possible manual feeding. The furnace/smoke hood is the upper part of the furnace and has several tasks. First of all, it collects the process off-gas and shields the equipment from the process heat. Secondly, the hood is where the electrodes are placed and raw materials are charged. Hoods often include a cooling arrangement. For FeSi and CaSi production, Söderberg electrode technology is used. For silicon production, the electrode is often prebaked and screwed on top of the previous electrode depending on the electrode consumption. In recent years, an electrode has been developed utilising a combination of the Söderberg technology and a graphite core with a stable iron electrode casing. This combined electrode allows the implementation of the Söderberg technology in the production of silicon metal. The aims are to reduce the iron impurities caused by the electrode casing and to reduce the high costs of prebaked graphite electrodes [233, COM 2008], [226, Nordic Report 2008].

The semi-closed furnace has been introduced to control the suction of air into the furnace top, thereby reducing the total gas stream from the furnace. This increases the gas temperature and requires an improved temperature control on the off-gas side, but at the same time allows for an even higher energy recovery. The process off-gas which contains silica fumes is cleaned in a bag filter. The liquid metal is tapped continuously or at regular intervals. The metal is cast from the ladle after the tapping is finished. Transportable tapping vessels can be brought to the tapping position by suitable vehicles or by overhead cranes. The metal can also be directly tapped to the casting area without using transport vessels. The silicon alloy is then cast into moulds and crushed by jaw, rotary or roll crushers or granulated in water.

In semi-closed furnaces, an energy recovery system can be implemented, although this largely depends on the local parameters/circumstances (applicability). Figures 8.5 and 8.6 outline the energy balances for a silicon production process in a semi-closed furnace with and without energy recovery.

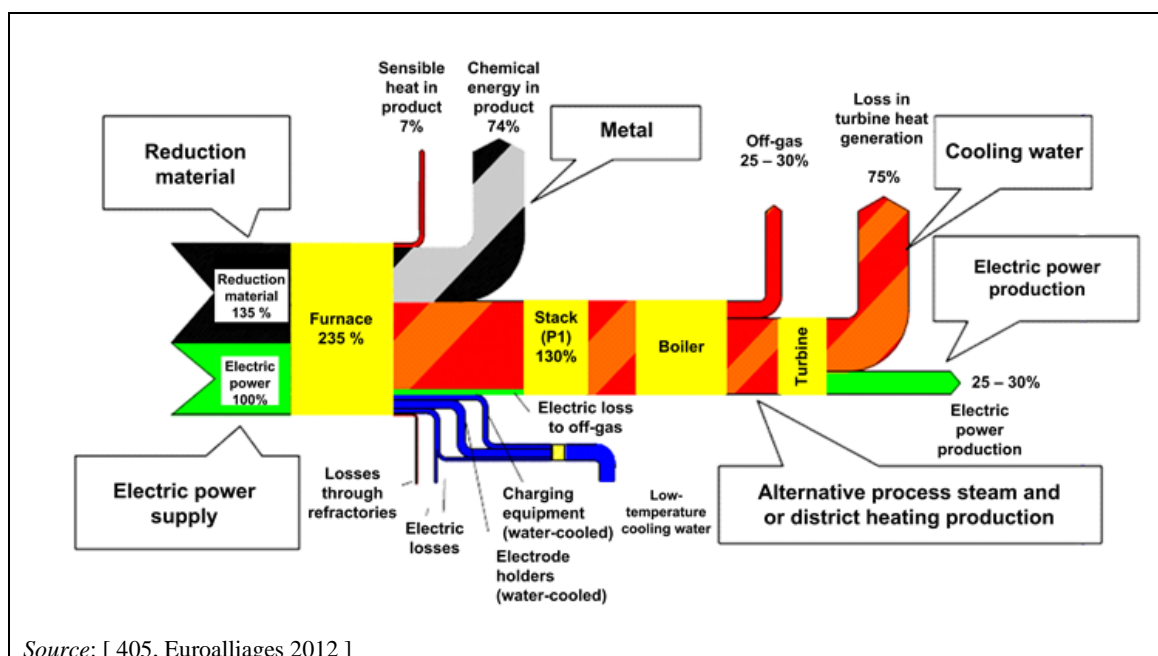

Figure 8.5: Energy balance for a silicon production process with energy recovery

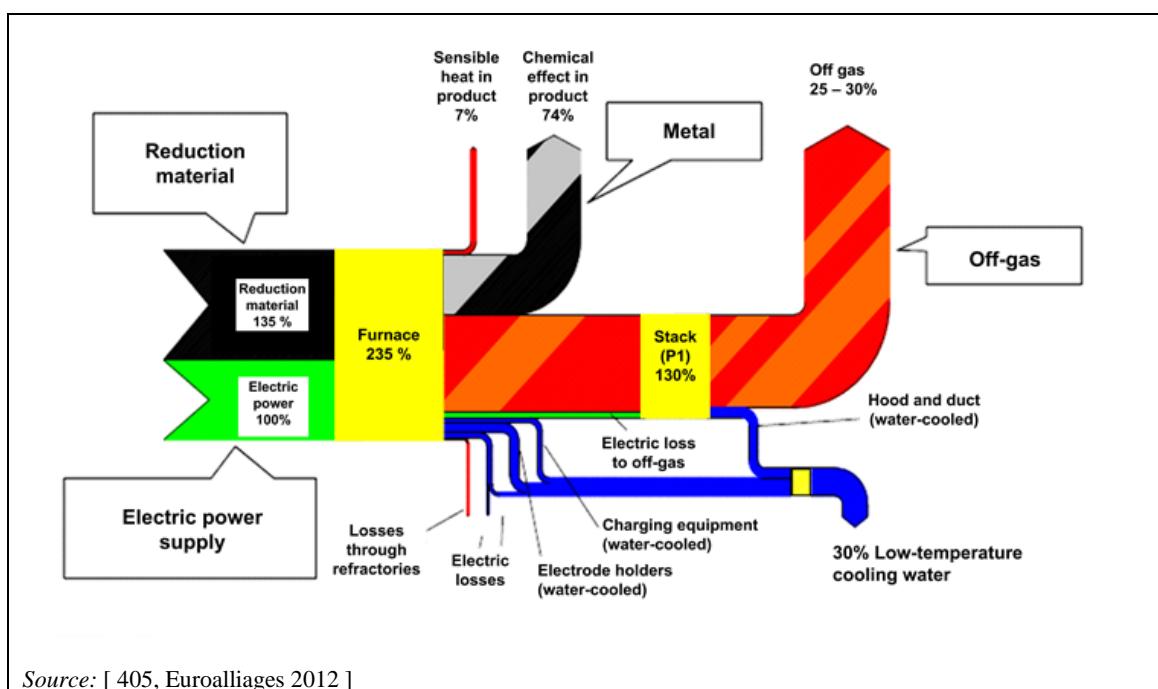

Figure 8.6: Energy balance for a silicon production process without energy recovery

It should be noted that the production of silicon metal and ferro-silicon is an almost slag-free process, as nearly all the impurities present in the raw material are transferred to the products, metal or micro-silica. To obtain a higher purity metal, a further refining step is needed. The refining takes place by oxidising the impurities in a ladle. Injection of oxygen gas or air is done through immersed lances, porous plugs in the ladle bottom or injectors. Correcting slag can also be added to improve the refining process. The refining stage is covered with a fume collection system, e.g. a fume collection hood, which is connected to a bag filter.

8.1.3 Ferro-manganese and manganese alloys

Ferro-manganese is another bulk ferro-alloy of great importance, mainly in the steel and stainless steel industries. Initially employed as a deoxidising and desulphurising agent, today ferro-manganese is mostly used to improve the hardness and wear resistance of steel. Ferro-manganese and other important manganese alloys can basically be classified as [226, Nordic Report 2008]:

- high-carbon ferro-manganese (HC FeMn): Max. C content of 7.5 %;
- medium-carbon ferro-manganese (MC FeMn): Max. C content of 2.5 %;
- low-carbon ferro-manganese (LC FeMn): Max. C content of 0.75 %;
- silico-manganese (SiMn): Max. C content of 2.0 %;
- low-carbon silico-manganese (LC SiMn): Max. C content of 0.10 %.

8.1.3.1 Raw materials

The production of ferro-manganese and silico-manganese is based on a blend of ores that contain manganese as a primary raw material. In order to obtain good process efficiency, the manganese ore and concentrates (with a low iron content) should be of a lump variety or as sintered material. Other raw materials that are required for the smelting process are iron ore and fluxing agents such as limestone and dolomite. Coke and low volatile coal are used as a reducing agent and, in the case of HC FeMn production in a blast furnace, also as an energy

source. For the production of silico-manganese, rich ferro-manganese slag, ferro-silicon scrap, silicon skulls and quartz are needed.

8.1.3.2 Pretreatment techniques

To use fine ores in the production of ferro-manganese, an agglomeration, pelletising and sintering step is used. Besides ore fines, the burden for sinter incorporates fuels (coke fines, coal fines, gas for ignition) and fluxes like limestone and dolomite as well as recycled fines and dust. Sintering is used in order to achieve a more suitable size and to reduce the natural ore to an intermediate metallurgical-grade raw material. The main advantages of the agglomeration and sinter process are [104, Ullmann's Encyclopedia 1996]:

- fine ore, which has a limited application and value in conventional smelting, is agglomerated and converted to a superior product;
- reduced gas volumes, and hence fewer furnace eruptions result when smelting sinter;
- furnace availability and operating loads are increased;
- better porosity of the burden with easier penetration and elimination of the gas generated by the reduction reactions.

For the production of HC FeMn and SiMn, travelling grate sintering is usually applied. In the grate sintering technology, sintering of the burden is achieved by batch in a static way. For each cycle, burners are positioned above the burden and fuel is consumed until the layer is properly sintered. At the end of the sintering cycle, burners are removed and the layer is collected by rotation.

The off-gases generated during sintering can be dedusted with an electrostatic precipitator and fabric filter. A complementary filtration of the off-gas produced during sintering and cooling of the sinter can be achieved using cyclones or fabric filters.

8.1.3.3 Production of ferro-manganese and silico-manganese

8.1.3.3.1 High-carbon ferro-manganese

High-carbon ferro-manganese (HC FeMn) is produced by the carbothermic reduction of lumpy or sintered manganese ore in a three-phase submerged electric arc furnace.

The commonly used electric arc furnaces are the closed, semi-closed and open types, which has no or only limited consequences on the furnace itself, but does affect the gas composition, flow rate, recovery and dedusting system used. The diameter of the furnace varies from 2 metres to 20 metres. Smaller furnaces have the advantage of being more flexible, because they can switch more easily between different products.

The raw material is fed to the smelting process by gravity from storage bins above the furnace. The feeding tubes are placed around the electrodes in order to ensure an even distribution of raw material to the furnace.

The electric arc furnace for the production of HC FeMn should be adapted compared to the furnaces that are normally used to produce ferro-alloys. Due to the high vapour pressure of ferro-manganese, the smelting process needs a careful temperature control because the charge should not be overheated. The vapour pressure together with the relatively low resistivity of the ferro-manganese burden results in the electrodes having a low current density. As a consequence, the furnace should be operated at a low voltage which requires the electrodes to have a larger diameter for the high current that is needed for the process. A typical closed electric arc furnace for the production of ferro-manganese operating with Söderberg electrodes is shown in Figure 8.7.

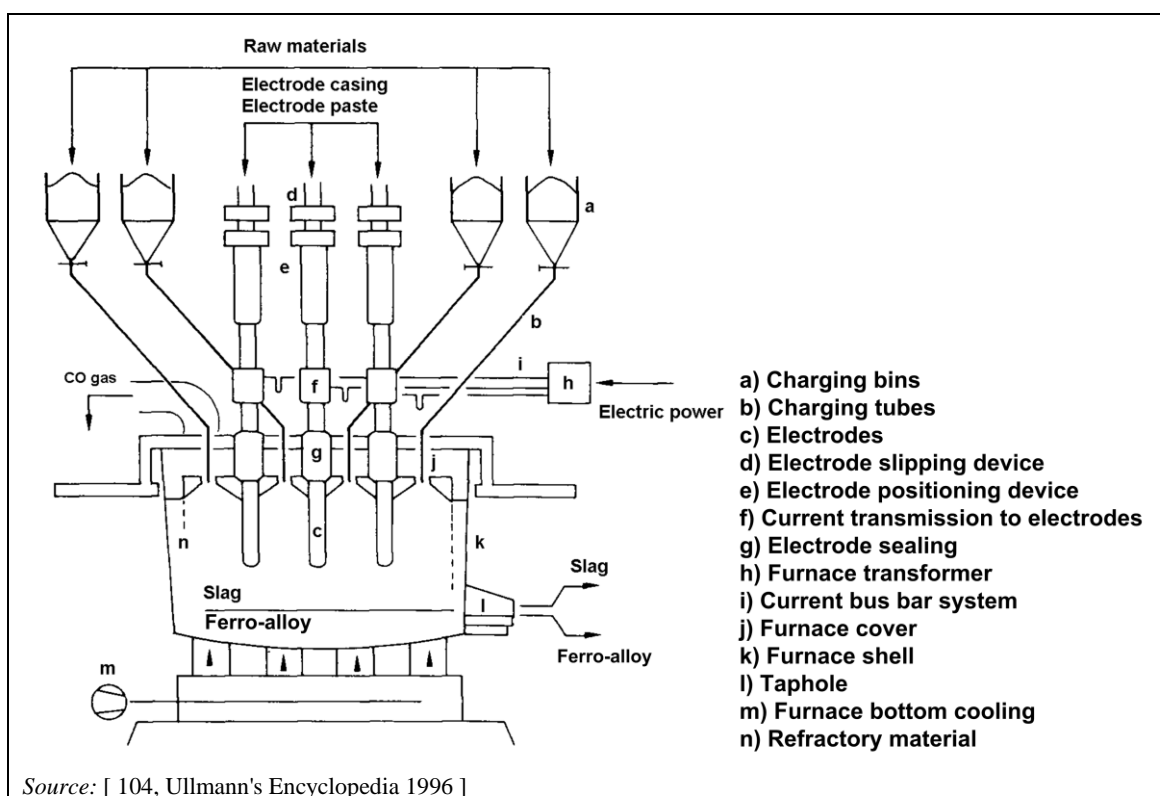

Figure 8.7: Closed electric arc ferro-manganese furnace operating with Søderberg electrodes

Electric arc furnaces for the production of ferro-manganese are operated only with self-baking Søderberg electrodes. Because of the large diameter, the use of prebaked electrodes is uneconomical compared with Søderberg electrodes. (See Figure 8.7).

Søderberg electrodes consist of a mild steel or stainless steel casing which is stiffened with internal fines and filled with a carbonaceous paste, consisting of a solid aggregate, usually calcined anthracite, and a binder of coal tar pitch. The tar becomes plastic when hot and fills the entire volume of the casing. On further heating of the electrode by the current and furnace heat, the paste is baked and becomes solid [104, Ullmann's Encyclopedia 1996].

The molten metal and the slag can be tapped off continuously or at regular intervals. The metal is cast into moulds lined with crushed ferro-manganese. A casting machine can also be used for casting the liquid metal. The solidified metal is then crushed and screened for the specific needs of the customers. Slag is normally obtained as rich slag (with about 30 % manganese) and is used further for the production of silico-manganese.

There are some facilities where the CO-rich off-gas is used to produce electricity. The CO-rich gas can also be utilised for other industrial uses, for instance as a raw material for chemical synthesis.

8.1.3.3.2 Medium-carbon ferro-manganese

For the production of medium-carbon ferro-manganese (MC FeMn) two different routes can be used:

- the silicothermic reduction of manganese ore;
- the decarburisation of HC FeMn in an oxygen-blown converter.

The most important process in the EU is the decarburisation of HC FeMn, which is also known as the refining process of HC FeMn.

For the decarburisation of HC FeMn, oxygen is blown into the molten metal, which is tapped off from the furnace into a ladle. The oxygen blown into the melt oxidises part of the manganese and increases the bath temperature from about 1350 °C to 1550 °C. With increasing temperatures, the carbon present in the HC FeMn also tends to be oxidised which again raises the temperature from 1550 °C up to 1750 °C. The oxidation of carbon consequently reduces the carbon content of the ferro-manganese. For the production of MC FeMn, the decarburisation process ends when a corresponding carbon content of about 1.3 % is reached. The high temperature also leads to the vaporisation of ferro-manganese which leaves the process as fumes. The fumes can be collected using hoods and further abated using a bag filter or electrostatic precipitators (ESPs) before being sent back to the HC FeMn smelter or sold.

In contrast to the refining process which uses HC FeMn as a raw material, the silicothermic process needs manganese ore and lime or a high-grade slag and silico-manganese. The reduction itself is performed in a three-phase electric arc furnace, with electrodes made of graphite. At the end of the cycle, the molten alloy and the slag are cast and separated. The slag is recycled, after cooling and crushing, as a raw material to the silico-manganese production plant. The fumes of the furnaces will be dedusted in a fabric filter. With the silicothermic reduction, production of MC FeMn containing < 1 % carbon is possible.

The main advantages of the refining process are the lower operating and capital investment costs. The main advantage of the silicothermic process is the production of low-carbon ferro-manganese in the same process.

8.1.3.3 Low-carbon ferro-manganese

Low-carbon ferro-manganese (LC FeMn), which usually contains less than 0.75 % carbon, is traditionally produced by a silicothermic process route. A rich slag is suitable as a raw material due to its low level of impurities. Also, the presence of already-reduced manganese oxides in the rich slag is favourable for the process. The production of LC FeMn takes place in an electric arc furnace very similar to that used for MC FeMn produced by a silicothermic process. The slag obtained is used for silico-manganese production as a raw material or sold for other applications in the metallurgical industry.

Recent process developments have made the decarburisation of HC FeMn an economical and environmentally favourable processing route for LC FeMn. A carbon content of less than 0.5 % can be achieved, but the level usually produced is 0.75 % [226, Nordic Report 2008].

8.1.3.4 Silico-manganese

Silico-manganese is required as an alloying element in the steel industry as well as a raw material to produce MC and LC FeMn. The production of silico-manganese is based on manganese ore or sinter and quartz as raw material. Instead of manganese ore, a rich ferro-manganese slag like that produced as rich slag in HC, MC and LC FeMn production may be used as a manganese source. Silico-manganese is only produced in submerged electric arc furnaces, which can be closed, semi-closed or open types. The furnaces are the same or very similar to those used for HC FeMn production and often a furnace is operated with alternate campaigns of each alloy. Depending on the composition of the feed mix, silico-manganese with a silicon content from 15 % to 35 % can be produced. For proper furnace operation and effective silicon reduction, it is necessary to insert the electrodes deeper into the burden in order to reach the high temperature needed for the process.

8.1.4 Ferro-nickel

8.1.4.1 Raw materials

Ferro-nickel (FeNi), as well as ferro-chrome, is the major alloying agent in the production of stainless steel. Laterite ore is the main raw material. Laterite ore is characterised by a relatively low nickel content (1.2–3 %) and a high moisture content (up to 45 %) together with chemically bound water in the form of hydroxide [104, Ullmann's Encyclopedia 1996]. Typical European ores contain 1–3 % nickel and have a moisture content of 5–10 %.

Besides laterite ore, coke and/or coal are the other raw materials that are needed in ferro-nickel production. Coke or coal is needed as a reducing agent, as ferro-nickel production takes place by a carbothermic process. FeNi can also be produced from secondary raw materials, such as spent catalysts and sludge from the galvanising industry.

8.1.4.2 Production of ferro-nickel from primary raw materials

The production of ferro-nickel from primary raw materials is carried out exclusively by the rotary kiln electric furnace process. As already mentioned, the raw material can carry a significant amount of water. Consequently, when there is a high moisture content, the first step of the process is a drying operation. Drying normally takes place in a directly fired rotary dryer where the moisture content can be reduced from about 45 % to 20 %. The resulting emissions are treated in an abatement system such as an ESP. Further drying to below 20 % should be avoided though, in order to limit dust generation in the subsequent calcining and smelting process.

The next process step is homogenisation where the different ores are mixed with coal, coke and pelletised dust, which is recycled from the main process. The feed is then fed to a rotary kiln. The rotary kiln is used to dehydrate the ore by calcination and to pre-reduce the nickel and iron oxide. The process takes place at about 800–1000 °C. The calcining and pre-reducing process results in a furnace feed that contains the nickel as a metal and the pre-reduced iron, mostly in the form of iron(II) oxides.

The hot pre-reduced calcine can be introduced directly to the smelting furnace, or by ladles. These may be used for two reasons; first to conserve heat, and second to also add the coke or coal required for complete reduction before they are discharged into the electric arc furnace, where melting and final reduction occurs [110, Anthony, T. 1997].

Ferro-nickel smelting takes place in open bath semi-closed electric arc furnaces with submerged electrodes. In the electric arc furnace, the reductive smelting operation occurs by the combined action of carbon electrodes and added solid carbonaceous reducing agent. The choice of the most suitable operation mode (open bath or closed bath) depends mainly on the oxides content of the slag (primarily FeO, SiO₂, MgO, CaO) as well as the mass ratio between the slag and nickel metal.

To reduce a high content of nickel oxides, the burden commonly contains an excess of carbon. This also increases the amount of iron that will be reduced and the final carbon content of the crude ferro-nickel. To reduce the iron and carbon content, a further refining step is necessary. To avoid further refining, several process improvements have been made. For instance, in the Ugine ferro-nickel process, no reducing agent is added. The electric arc furnace produces a molten ore, which is reduced to ferro-nickel by using ferro-silicon in a further ladle furnace. In the Falcondo ferro-nickel process, a shaft furnace is used instead of a rotary kiln. In the shaft furnace, a briquetted ore is reduced with a reducing gas (low-sulphur naphtha). The subsequent electric arc furnace is then only used to melt the metal and to separate it from the slag.

Ferro-nickel produced by the conventional process needs further refining. Besides the reduction of iron and carbon, the impurities like sulphur, silicon and phosphorus should be removed. For ferro-nickel refining, a variety of equipment is available, e.g. a shaking reaction ladle, an induction furnace, an electric arc furnace and oxygen-blown converters. The purified ferro-nickel is cast into ingots or granulated under water.

The off-gas from the calcination rotary kiln, the electric arc smelting furnace and the refining step is treated by an appropriate abatement system such as a dry ESP. The filtered dust can be pelletised and recycled to the raw material blending station.

8.1.4.3 Production of ferro-nickel from secondary raw materials

Ferro-nickel can also be produced from residues that contain nickel. These residues, mostly spent catalysts from grease production, are burnt in a rotary kiln in order to concentrate the nickel content as nickel oxide in the flue-dust. The off-gas is cleaned in a membrane fabric filter, where the collected dust is used as the raw material for the smelting process. The production of FeNi then takes place in a submerged electric arc furnace. The molten alloy is tapped, granulated in water and packed in drums or big bags for supply.

8.1.5 Ferro-vanadium

The addition of ferro-vanadium to a steel melt increases the tensile strength and the high-temperature strength of carbon steel even if small amounts are added. Vanadium alloyed steel is therefore used for high-speed cutting tools.

Ferro-vanadium (FeV) can be produced by a carbothermic or a metallothermic reduction of vanadium oxides, assisted by the presence of iron. Because carbon is used in a carbothermic reduction, the final carbon content of the produced alloy is high. The production of ferro-vanadium using carbon as a reducing agent is therefore only possible if there are no requirements for a low carbon content.

8.1.5.1 Raw materials

The base materials for ferro-vanadium are vanadium oxides of different oxidation states produced in the vanadium oxide plant, with lime, aluminium and scrap iron included as additives.

Purchased raw material used in FeV production is delivered by truck or train. The raw materials V_2O_3 and V_2O_4 are stored temporarily in refined steel containers. In a further step, these raw materials are kept in a vanadium hopper. V_2O_5 is temporarily stored in a locked poison storeroom. Before use, V_2O_5 is kept in a raw material hopper.

The auxiliary agents used in FeV production are delivered by truck or train and temporarily stored in defined storerooms. Before use, these auxiliary agents are stored in a hopper, from where weighted amounts will be taken for use in the production process.

A given composition of the vanadium raw materials and the auxiliary agents are taken from the hoppers and transported via conveying tubes to a weighing scale. From there, weighted amounts are transported to the furnaces.

8.1.5.2 Production of ferro-vanadium

Ferro-vanadium is usually produced by an aluminothermic reduction.

When necessary, grinding, sizing and drying can be carried out prior to charging the mix to the smelting process. The aluminothermic reduction of vanadium oxide is a self-sustaining process that can be carried out in a refractory-lined crucible. The reaction vessels used for this process can be of the following types:

- Refractory-lined crucible using a non-reusable lining.
- Refractory-lined ring placed into a pit that contains sand.
- Electric furnace where additional energy can be supplied either to increase the heat of reaction or to enable slag-refining operations to be carried out. The electric arc furnace is also used, because the FeV fines generated by FeV crushing can be remelted.

The smelting operation takes place in a batch process where the whole charge is transferred to the reaction vessel and ignited. After ignition, the combustion time for a common batch size of about 1 tonne of ferro-vanadium is only a few minutes. Due to the short reaction time, the content of vanadium oxides in the slag and the aluminium content in the metal may not reach equilibrium. The production in an electric furnace therefore has the advantage of keeping the charge in a molten state until the reaction is completely finished. The fumes from the process are exhausted and cleaned using fabric filters or wet scrubbers.

Depending on the process type, the slag and metal can be allowed to cool down in the crucible, or the slag and metal can be tapped together into ladles or into beds to allow the separation of the slag and the metal and to provoke rapid cooling. Tapping of the crucible requires extraction hoods and extraction rates sufficient to evacuate the fumes and the dust escaping during the tapping. The slag from the aluminothermic process can be used for further crucible linings or crushed and sized to be used in other industries (as aggregate in the steel industry and as basic material in the refractory industry). The metal block can be air-cooled or water-cooled which facilitates further crushing. All crushing and sieving operations have dedicated dust extraction units, from where the dust is returned to the production process at the most appropriate point to ensure a continuous recycling of recovered products.

The following figure shows the production route for ferro-vanadium.

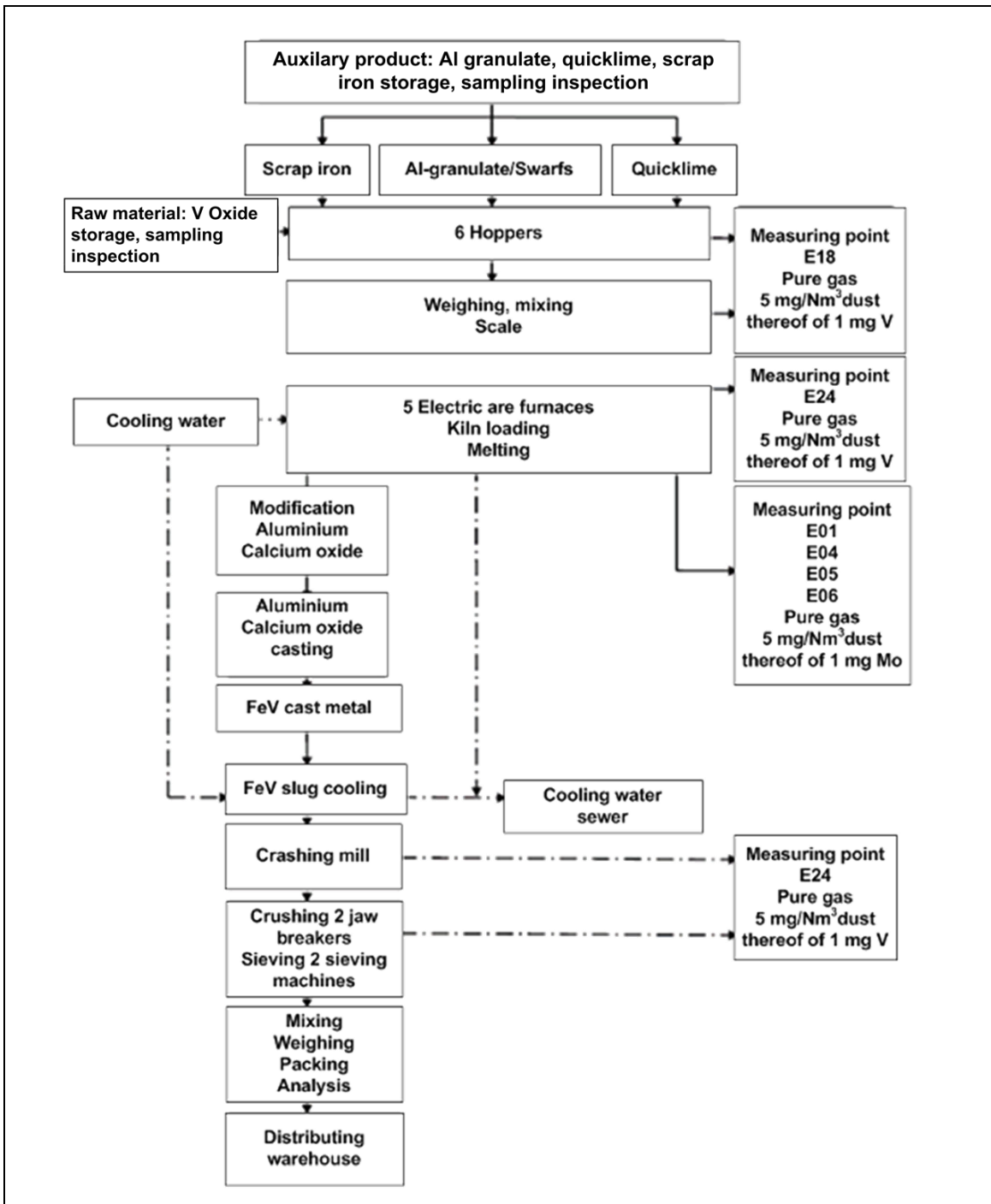

Figure 8.8: Ferro-vanadium production flowsheet

In the premelt plant, nickel, vanadium oxides and molybdenum oxides are used for the production of ferro-molybdenum-nickel alloys and ferro-vanadium alloys. The raw materials are melted together with lime, to create slag, in an electric arc furnace. With aluminium, ferro-silicon or coke, the metallic oxides are reduced to the metal. The slag resulting from the production is removed and sold to the steel industry as conditioner slag. The metal is poured off, either to form granulated metal or to form blocks.

8.1.5.3 Post-production operations

The packaging of the finished crushed ferro-vanadium alloy occurs in the packing station. The content of the FeV finished product hopper is discharged over a vibrator chute to several packaging drums and weighted via a calibrated scale. The finished FeV alloys are loaded into sheet steel drums, big bags, PE bags, drums or tin plate boxes and palletised according to customer specifications. Afterwards, the drums and big bags are secured with strapping bands.

In the pulveriser plant, fine-grained FeV materials are pulverised to powdery alloys, which are mainly used in the production of welding electrodes. The undersized particles of the individual alloys are pre-ground to a grain size of < 3 mm in the pulveriser plant. The material is transferred into conical transport containers. All intermediate fractions are lifted via an assembly-hall crane to the respective feed hopper. The next grinding step occurs in the Palla (rod) mill. The obtained powdery alloys are control-sieved via a double deck screen. After sampling and analysis, these alloys are stored in metal containers. This pulverisation process is also applied for ferro-molybdenum (Austria).

8.1.6 Molybdenite roasting and the production of ferro-molybdenum

8.1.6.1 Molybdenite roasting

Technical-grade molybdenum trioxide (MoO_3), also named roasted molybdenum concentrate (RMC) by REACH, is the main raw material in the production of ferro-molybdenum and alloys that contain molybdenum, as well as the starting compound for a number of other molybdenum-based products such as ammonium dimolybdate, sodium molybdate and molybdenum metal [104, Ullmann's Encyclopedia 1996]. Roasting as shown schematically in Figure 8.9 converts concentrated molybdenite (molybdenum sulphide ore) into technical-grade molybdenum trioxide for the metallurgical or chemical industry.

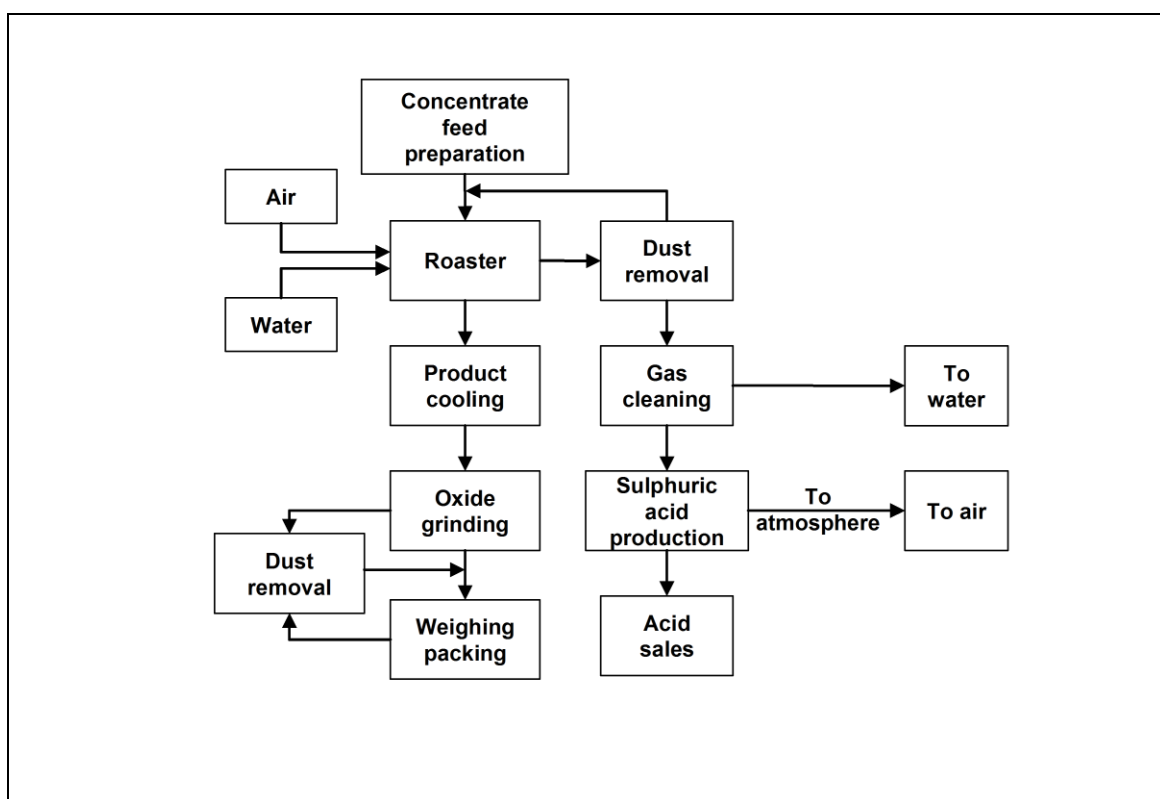

Figure 8.9: Molybdenite roasting flowsheet

The process of roasting molybdenite concentrate takes place in a multiple hearth furnace (see description in Section 13.1.1.3). Multiple hearth furnaces consist of a number of vertically arranged hearths. In the upper part of the furnace, additional energy is added in the form of natural gas (or a liquid fuel such as diesel), in order to evaporate water and bring the feed to roasting temperature.

The roasting process itself is exothermic and does not need additional energy, unless the heat losses associated with the centre axle column cooling air, radiation from the shell of the roaster, or the discharge of hot oxide from the roaster are significant. By means of induced-draught fans, the roaster operates at a negative pressure relative to atmospheric pressure. This serves to control the inflow of ambient air for oxidation and cooling, and prevents any emissions of sulphur dioxide to the environment. Airflow, transportation rate, and sometimes water spray injection control the reaction rates and temperatures. The molybdenum oxide produced is discharged from the roaster and then cooled, ground to a fine powder, sampled and analysed prior to weighing and packing.

The off-gas from the process contains large amounts of sulphur dioxide and dust (up to 15 % of the concentrate feed). The dust content can be removed from the gas stream using (multi-) cyclones and high-temperature electrostatic precipitators together and recycled to the concentrate feed entering the roaster. The sulphur dioxide is normally converted into sulphuric acid in an adjacent sulphuric acid plant. The conversion of sulphur dioxide into sulphuric acid is described in detail in Section 2.7.1. In addition to the generation of dust and sulphur dioxide, elements such as rhenium and selenium are vaporised and emitted. These elements can be removed from the gas stream by wet scrubbing, with a subsequent treatment plant for the scrubbing liquid. Selenium is mostly recovered by flocculation, decantation and filtration, and rhenium is generally recovered by solvent extraction or ion exchange techniques. Other metals are removed using precipitation techniques.

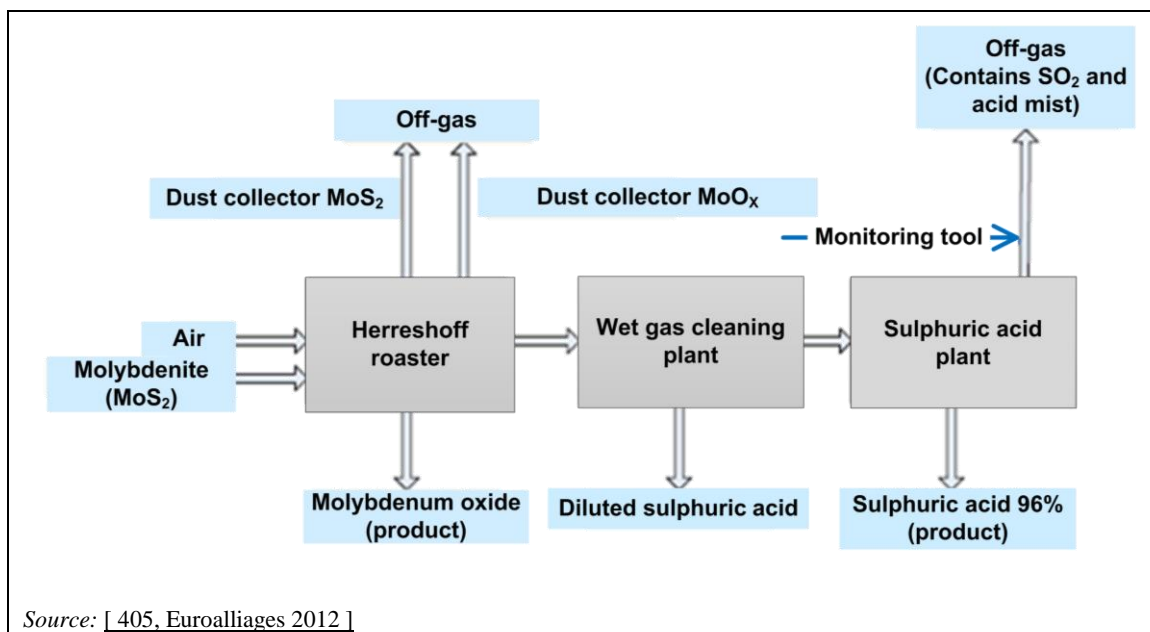

Figure 8.10: Molybdenite roasting and gas cleaning (the Netherlands)

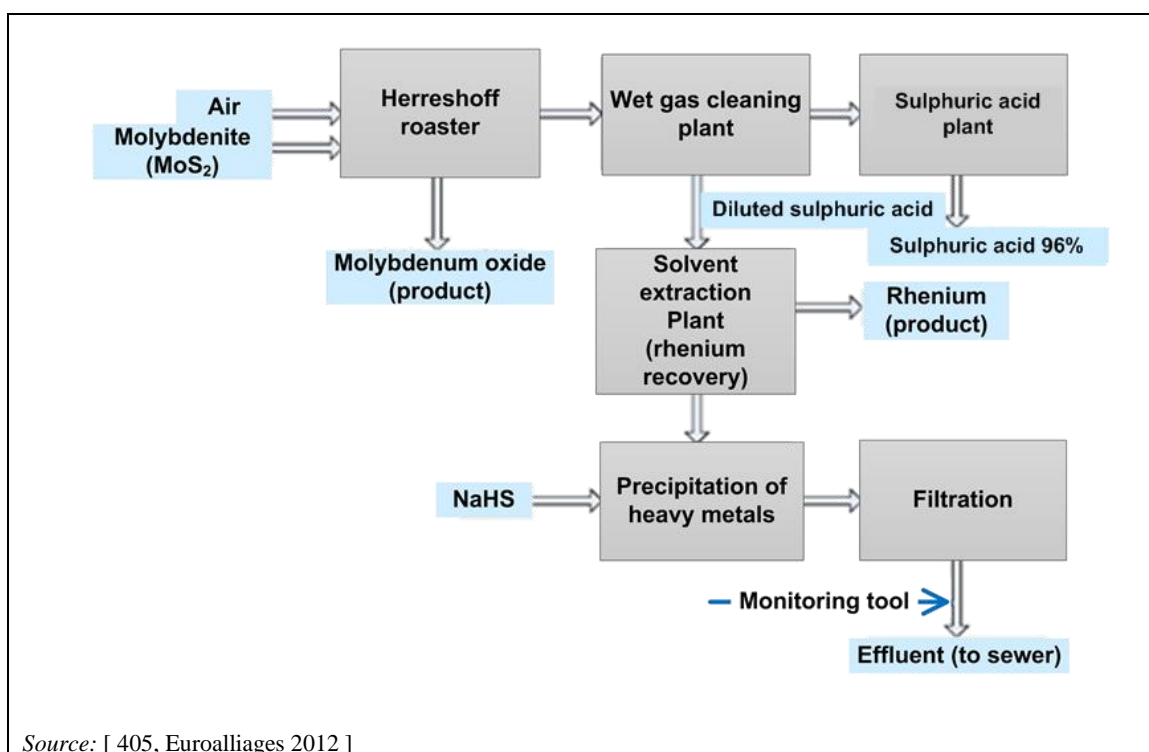

Figure 8.11: Molybdenite roasting and waste water treatment (the Netherlands)

In the toll conversion of molybdenum concentrates, batches of raw material can have high differences in molybdenum content (46–59 %) and in other components. The roasting of batches with different grades influences the treatment of the off-gases.

8.1.6.2 Production of ferro-molybdenum

Ferro-molybdenum can be produced either by the carbothermic or metallothermic reduction of molybdenum oxides. Due to practical reasons like the smelting equipment used for the process and the reduced manufacturing costs, the metallothermic production of ferro-molybdenum is much more widespread than the carbothermic reduction. Thus the latter is not described.

The following figure shows the production route for ferro-molybdenum.

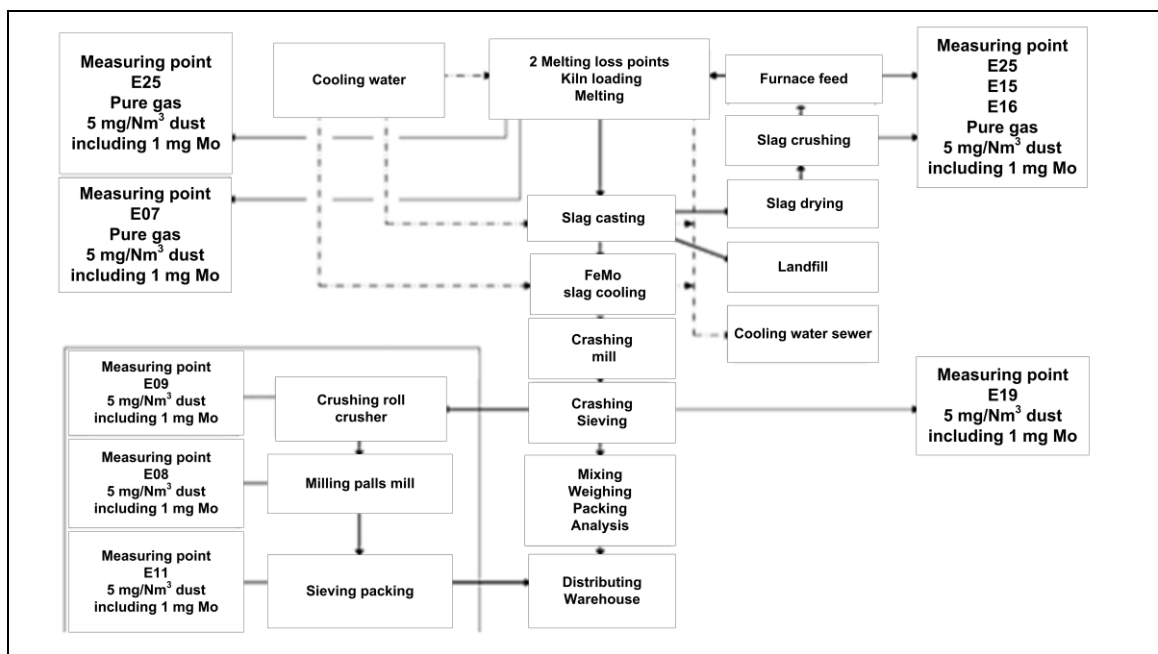

Figure 8.12: Ferro-molybdenum production flowsheet

8.1.6.2.1 Raw materials

The production of ferro-molybdenum is based on the use of molybdenum oxides as raw material. Besides the main raw material, molybdenum trioxide, iron oxide or millscale iron scrap, steel punchings or turnings are needed to produce ferro-molybdenum. Lime and fluorspar are commonly used as fluxing agents and charcoal, silicon (ferro-silicon) and some aluminium are needed as a reducing agent.

8.1.6.2.2 Metallurgical production of ferro-molybdenum

Metallurgical reduction is the most common process used for the production of ferro-molybdenum. Due to the higher Gibbs free energy of aluminium compared with silicon, ferro-silicon is the preferred reducing agent in order to ensure safe process conditions. However, to obtain the required heat balance for the reaction, it is necessary to use a small amount of aluminium.

The metallurgical process requires dry raw material for the process. Millscale that arrives wet is stored in a covered bunker prior to screening and drying in order to prevent diffuse losses. Steel scrap that also arrives in bulk is offloaded and stored in a covered bunker. Smooth, efficient smelting reactions require a blend of suitably sized raw material, this is of particular importance with respect to the oxides and the reducing agents. Fluorspar is sometimes added to improve the slag and metal separation. To get the right size raw material, it is often necessary to grind and screen ferro-silicon. All the pretreatment operations like grinding, screening, transferring and blending should be carried out using dust control measures.

The smelting operation can be done in a number of ways, the most common are as follows [125, Euroalligies (B) 1998]:

- The use of long pits that contain sand where refractory-lined steel cylinders are placed to form crucibles that contain the metallurgical reaction. The reaction itself can be carried out in different ways. The 'top-fired reaction' takes place when the whole charge is placed in the crucible and then ignited from the top. Alternatively, only a part of the charge may be placed in the crucible and ignited, the remainder of the charge can then be added as the reaction proceeds (fed reaction).

- The use of refractory-lined crucibles that are placed inside a chamber that can be enclosed. As in the previous description, the reaction can then be carried out by placing all of the charge in the crucible and igniting it, or by adding only a part of the charge, initiating the reaction and then progressively adding the rest of the charge as the reaction proceeds.

As the reaction is caused by metals instead of carbon, the exothermic reaction does not generate CO or CO₂. Theoretically, no gas is generated at all. However, the intense heat generation creates a substantial updraught of the included and surrounding air and of any water vapour present. These fumes carry a substantial amount of dust particles.

The dust and fumes generated by the process must be extracted, recovered and recycled in order to protect the environment. The treatment of the fumes consists of classical dedusting units such as a settling chamber, cyclones and bag filters. The filter bags may be manufactured from special fabrics sometimes applied with additional coating to withstand high temperatures. The bag filter dust can then be fed directly back to the main smelting process. Good housekeeping is also necessary to recycle all splashes, floor sweepings, etc. in order to get an efficient overall molybdenum yield.

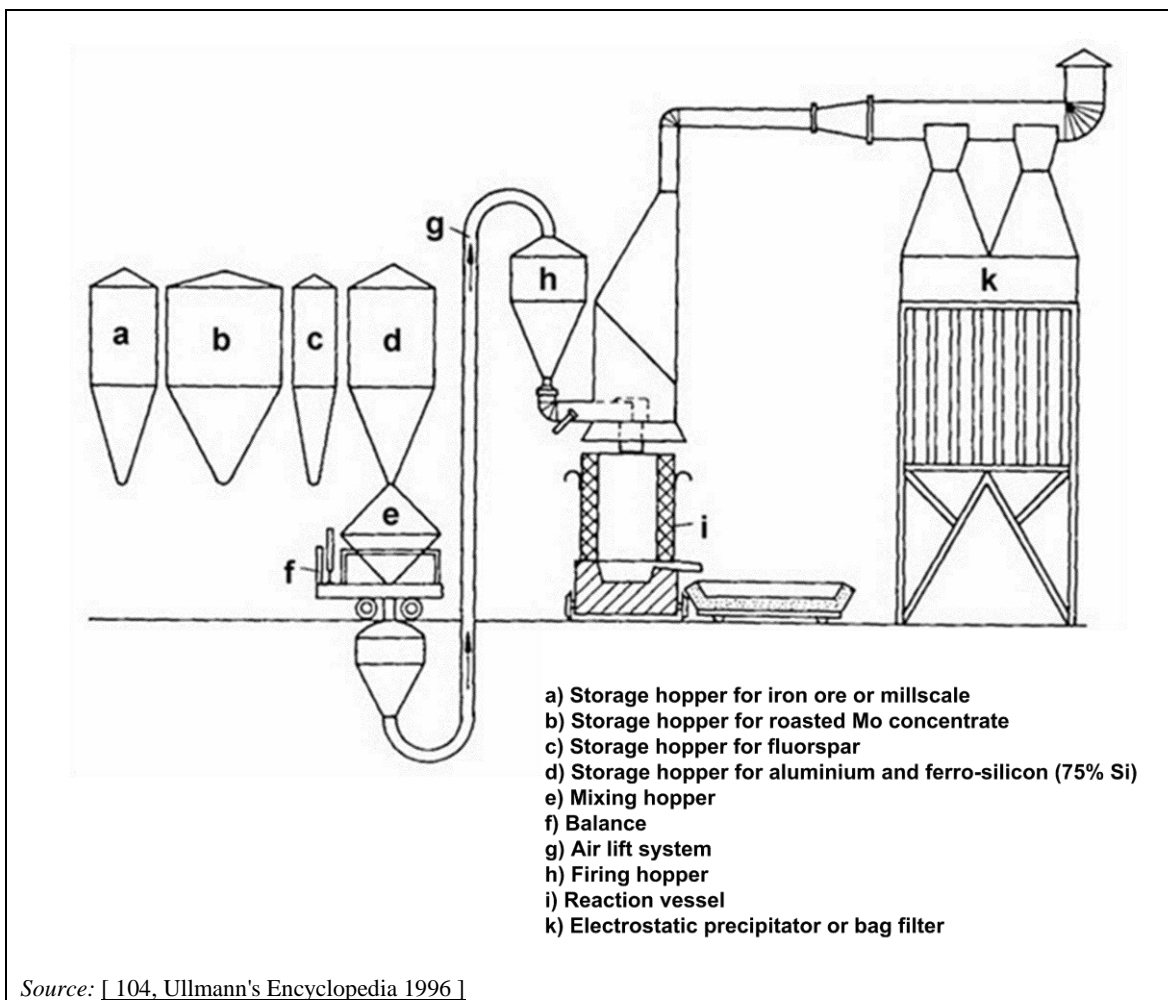

Figure 8.13: Metallothermic firing arrangement

The smelting process produces an alloy block that weighs between 2.5 tonnes and 4 tonnes. After the slag is separated, the hot metal block must be cooled. This can either be done by natural air cooling or by quenching in water. The cooled metal block is then broken into pieces

that can be fed into an integrated crushing and screening plant to produce the wide range of product sizes used worldwide.

A process flowsheet that demonstrates the principle steps of the metallothermic ferro-molybdenum production process is presented in Figure 8.14.

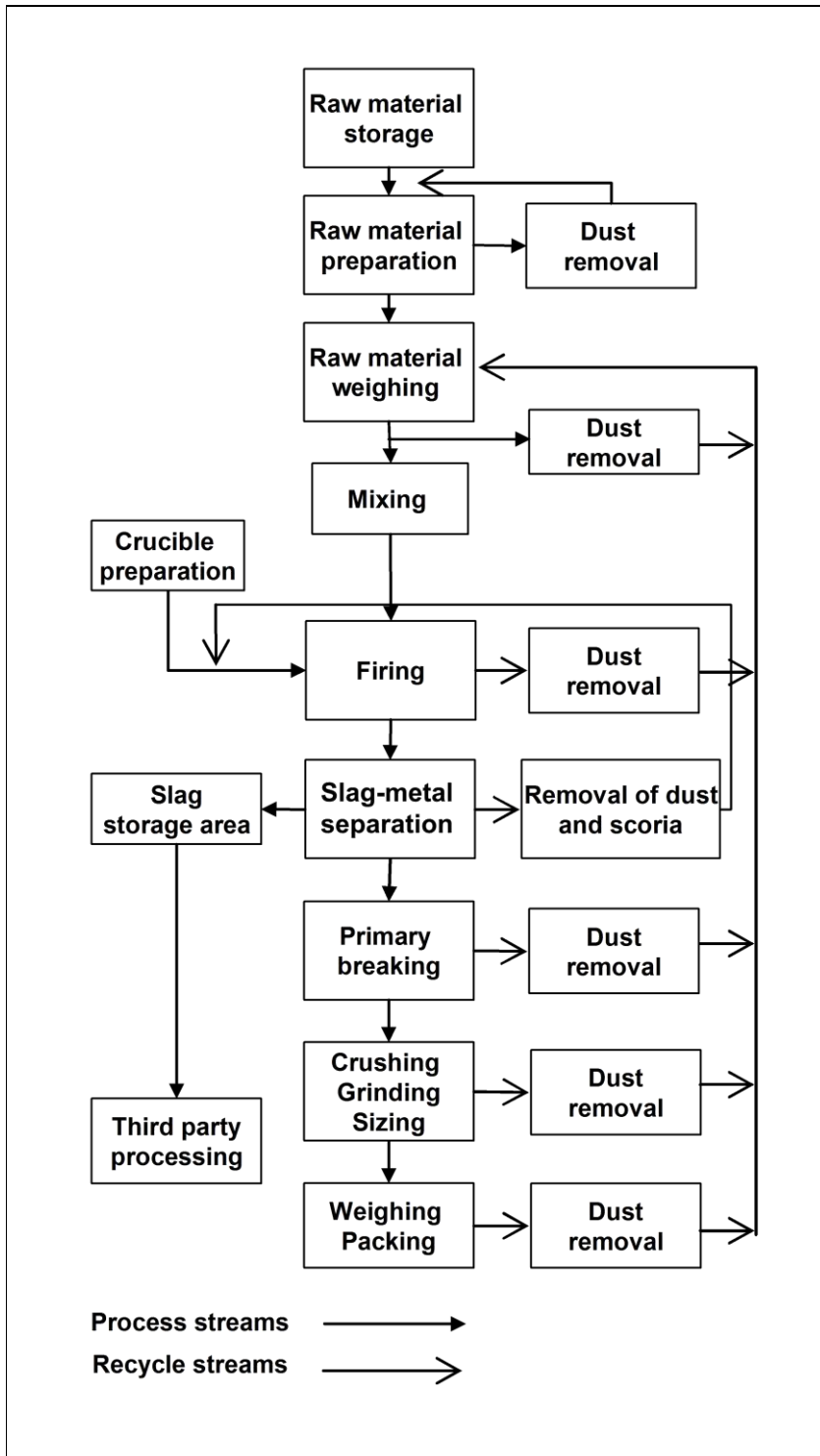

Figure 8.14: Production of ferro-molybdenum by metallothermic reduction

8.1.7 Ferro-tungsten

Ferro-tungsten, as well as tungsten melting base (TMB), which is made from secondary raw material, is mainly used to improve the properties of steel. Tungsten as an alloying element forms stable carbides and therefore increases the high-temperature strength and wear resistance of steel. Such steel (high-speed steel) is needed to produce high-speed cutting tools that can be used up to temperatures of about 600 °C. Tungsten will also increase a number of other properties of the steel, such as the hardness, yield strength and the ultimate tensile strength [104, Ullmann's Encyclopedia 1996].

8.1.7.1 Production of ferro-tungsten and tungsten melting base

Ferro-tungsten can be produced from different raw materials that contain tungsten oxides, e.g. wolframite, scheelite and hübnerite. The reduction of these minerals can be done either by carbothermic or metallothermic reduction, or by a combination of both.

The carbothermic process, which is known as the solid block melting process, takes place in an electric arc furnace. Due to the high melting temperature of ferro-tungsten, the alloy produced cannot be tapped off from the furnace. After the smelting has started, the metal accumulates in the bottom of the furnace. When the amount of metal has reached the desired weight, the furnace is switched off. The metal ingot can then be recovered from the furnace once the refractory lining has been removed. The metal is then crushed and screened. If several furnaces are used in parallel, the production can then take place as a quasi-continuous process. The off-gases from the furnace are treated by a gas purification system in order to minimise the environmental impact and to recover the tungsten trioxide in the flue-dust.

A combination of the carbothermic and metallothermic processes using both carbon and ferro-silicon as reducing agents is used to produce a ferro-alloy with a high tungsten content. The process is carried out in three successive stages in an electric arc furnace. In the first stage, a tungsten trioxide slag is produced, which is further reduced with ferro-silicon in the following stage. The third and final stage is needed to increase the tungsten content by refining the low-tungsten metal from the second stage by adding tungsten concentrates.

The metallothermic process is less economical because the process requires very pure and therefore expensive raw material. In order to keep the process self-sustaining, a mixture of silicon and aluminium is normally used as a reducing agent. The metal can be recovered from the furnace vessel after the cooling and removal of the furnace linings. Metallothermic production of ferro-tungsten is today only economically viable if there are special customer requirements.

TMB is a tungsten alloy that is produced from secondary raw material. The main sources are different kinds of tungsten metal scrap. TMB production is only a remelting and alloying process, which can take place in an electric arc furnace. The fact that more and more tungsten scrap is available on the market increases the use of a remelting process that requires less energy than the primary smelting process.

8.1.8 Ferro-titanium

Ferro-titanium can be produced either from primary or secondary raw material and is used for a variety of different purposes. As an alloying element, it increases yield strength and reduces the cracking tendency. In the production of stainless steel with a high chrome and nickel content, ferro-titanium is used to bond the sulphur [104, Ullmann's Encyclopedia 1996].

For the production of ferro-titanium, the primary raw materials are minerals that contain titanium oxide, such as ilmenite. The reduction is usually carried out by the metallothermic process since carbothermic reduction produces an alloy that contains too much carbon and is therefore not of interest as an alloying element in the steel industry. The production takes place as a batch process in a refractory-lined crucible or in an electric furnace, depending on the process variation.

In recent years, the availability of titanium scrap on the market has increased and therefore the production of ferro-titanium from secondary raw material is more common. The production of ferro-titanium is achieved by melting ferrous scrap and titanium in an electric induction melting furnace. The alloying process is a slag-free process.

Ferrous units are purchased to a specification in the form of mild steel solids. Titanium scrap is delivered to the site in container trucks. The feedstock includes lump scrap metal castings, wrought products and turnings (swarf) from machining processes. Upon receipt, materials are checked to ensure that they are not contaminated with radioactive materials. Large lumps of scrap are reduced in size by oxy-flame cutting. Swarf is chipped using a swarf pulveriser and then fed through a centrifuge to remove oil and moisture.

The titanium swarf is degreased in a rotary dryer, where the oil-bearing gases are led through a cyclone to remove dust and carry-over. These gases then pass through an afterburner, which is heated by a gas-fired burner. Combustion gases/fumes are either recirculated through the dryer or are ducted to a second cyclone. After passing through the cyclone, sorbent (sodium bicarbonate) is introduced to neutralise the gas stream and to prevent corrosion damage to the filtration plant. Finally, the gas passes through a ceramic filter before being discharged to the atmosphere via a stack.

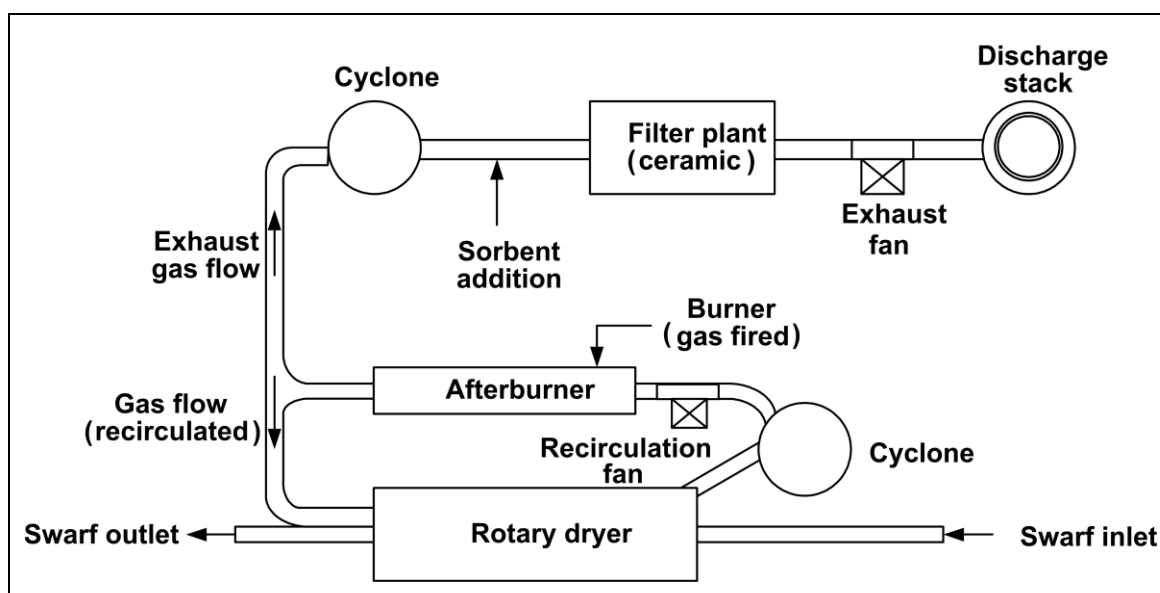

Figure 8.15: Gas-cleaning system for a degreasing plant

Furnace charges are calculated based on the analysis of the raw materials. The materials are weighed into pans and fed into an electric induction melting furnace. A chute system is used to feed in materials during the melting operation. When melting is complete, the molten metal is tapped into an ingot mould and a stream sample is taken for analysis. After cooling, the ingot is transferred to other operations such as breaking, crushing and grinding to achieve the required product size. Figure 8.16 presents a flow diagram for the production of ferro-titanium.

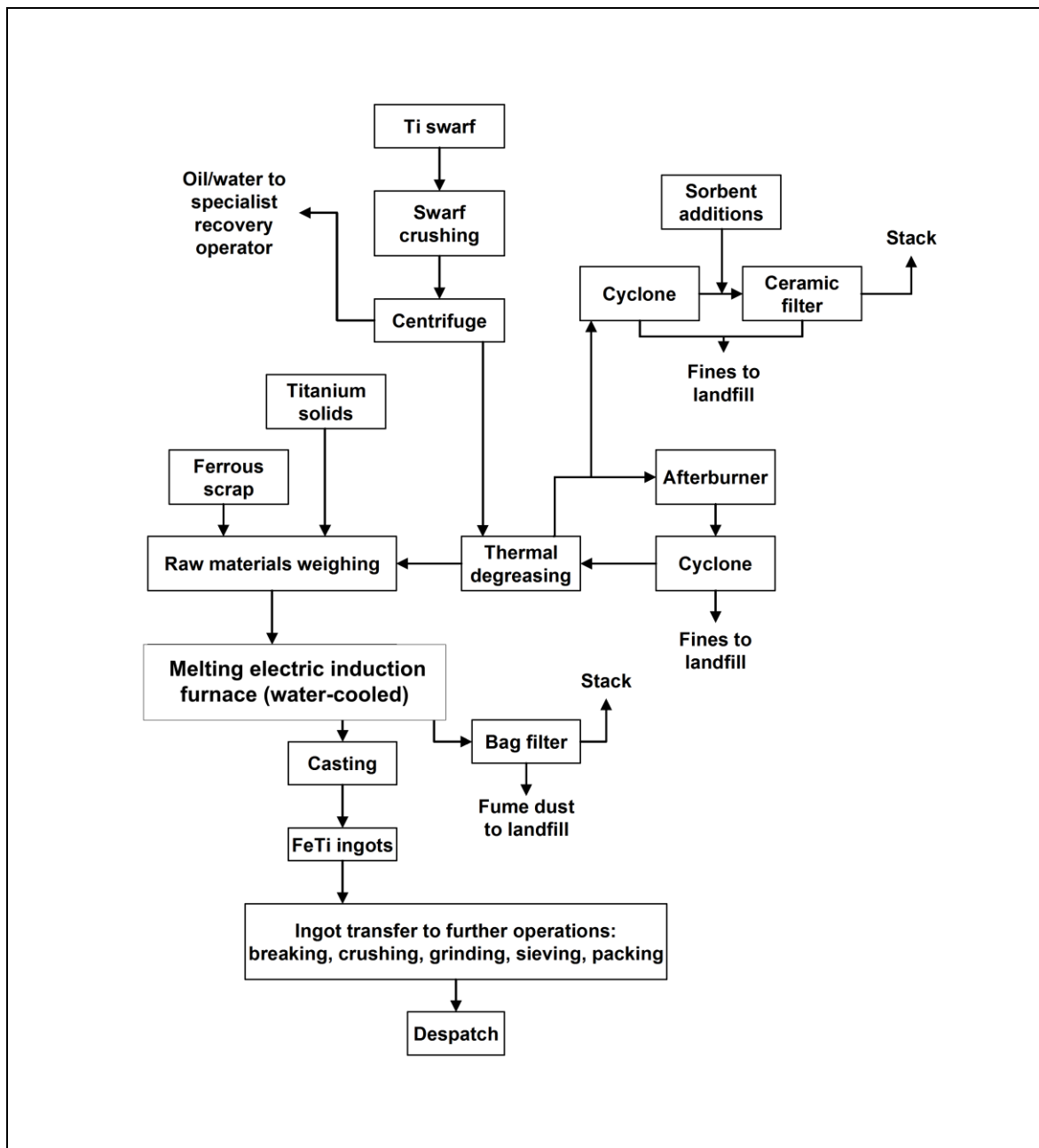

Figure 8.16: Flow diagram for ferro-titanium production

8.1.9 Ferro-boron

Ferro-boron is mainly used as an additive in steelmaking to increase the hardenability, creep resistance and hot workability because boron-alloyed steel is oxidation-resistant up to 900 °C. The raw materials needed to produce ferro-boron are boric oxides and boric acid. Carbon (charcoal), aluminium or magnesium is used as a reducing agent. The alloys can be produced by carbothermic or metallothermic reduction processes.

The raw materials arrive in a variety of containers for example drums, flexible intermediate bulk containers, pallets, stillages and polyethylene-wrapped bales. The materials are weighed out into enclosed bins at a specially designed weigh station. The bulk bags are discharged within a framework incorporating a sealing membrane, which prevents diffuse emissions. A local exhaust ventilation system vented to a filter unit furthers the removal of any dust.

The carbothermic reduction takes place in single- or three-phase submerged electric arc furnaces depending on the process specifications. Some variations of the carbothermic process exist. In one, boric oxides and iron oxides are reduced simultaneously with charcoal in a submerged electric arc furnace. In another process, boric acid, iron powder and charcoal are reacted in a Héroult-type electric arc furnace. Figure 8.17 shows the process for ferro-boron and boron alloy production.

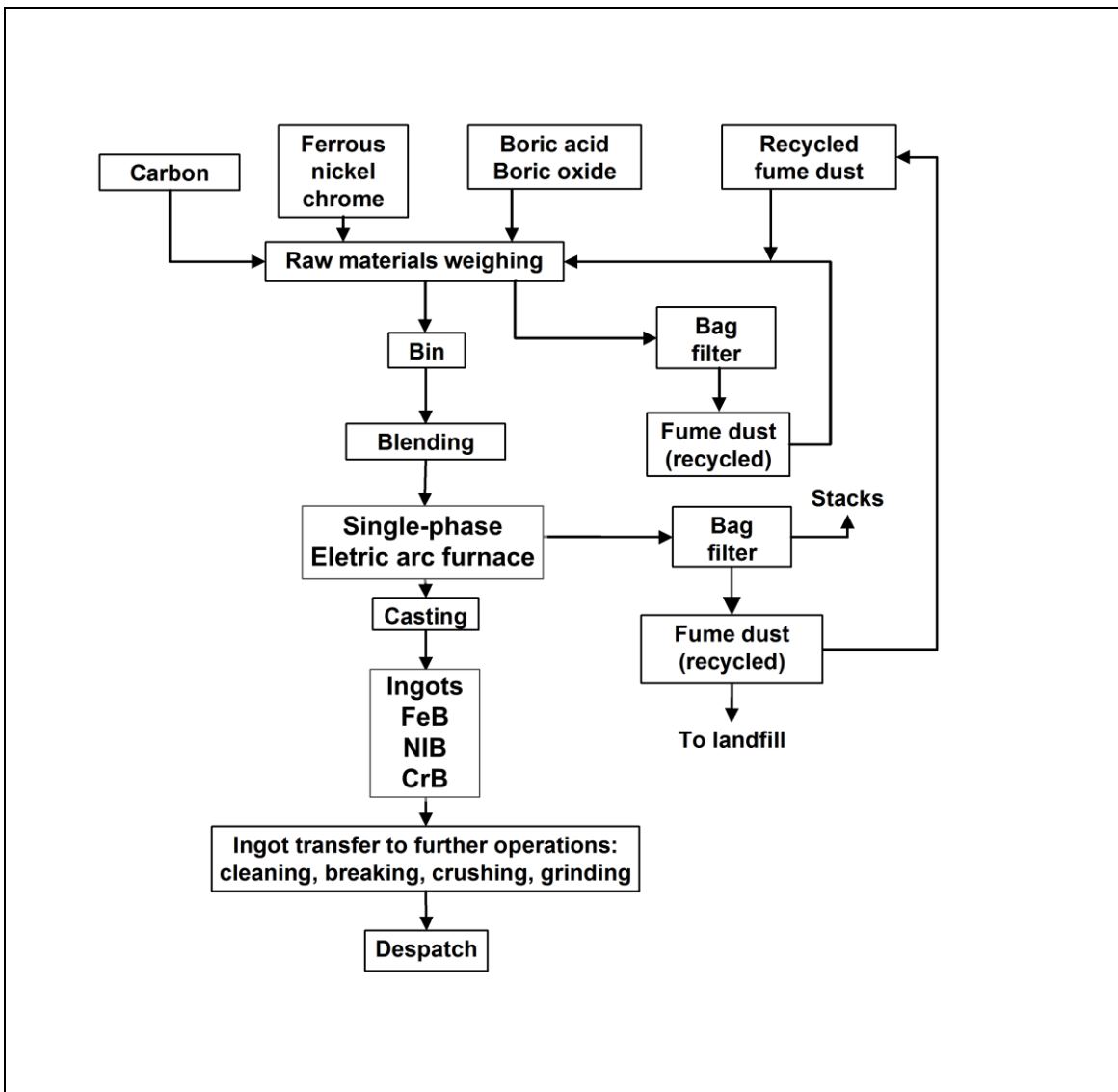

Figure 8.17: Process for ferro-boron and boron alloy production

The metallothermic process uses aluminium together with a small portion of magnesium as a reducing agent. This reaction is highly exothermic and needs only a few minutes to take place in a refractory-lined crucible. The reaction can be ignited as a whole charge or as a starting mix. After the reaction is finished, the metal alloy that builds up in the bottom of the furnace can be removed mechanically. It can then be crushed and screened in order to produce the desired particle size.

8.1.10 Ferro-niobium

Ferro-niobium as an alloying agent improves the corrosion resistance and weldability of steel and especially prevents the inter-crystalline corrosion of stainless chrome-nickel steel. The raw materials needed to produce ferro-niobium are ores and concentrates that contain niobium and iron oxide. The reduction occurs as an aluminothermic process. The reaction normally takes place in a refractory-lined crucible where the whole charge can be ignited or just a part of it that then serves as a starting mixture.

Niobium can be produced from pyrochlore ore, which also contains traces of polonium, which is a volatile, radioactive metal. The smelting of pyrochlore therefore requires enhanced safety and environmental procedures.

8.1.11 Production of ferro-alloys from secondary raw materials

Due to the large number of available secondary raw materials, especially metal oxides from the production of stainless steel, the recovery of ferro-alloys, mainly ferro-chrome, has become an important part of the ferro-alloy industry. The development of the various processes followed the increasing need of stainless steel manufacturers to treat their waste products in order to reclaim the valuable metal content and to limit or prevent the dumping of waste.

The main constituent of recovered materials is furnace dust, which contains a high proportion of zinc and other volatile metals (up to 30 %) besides the main components of stainless steel, Fe, Cr, Ni and Mo.

The total waste treatment market of these kinds of residues from the stainless steel industry in Europe is estimated to be approximately 200 000 t/yr corresponding to approximately 100 000 tonnes of alloys. Two thirds of this market is processed and converted into metal and enriched zinc oxide. The market is strongly related to the development of the stainless steel industry.

8.1.11.1 Raw material and its preparation

The typical raw materials for the production of secondary ferro-alloys are the following residues generated mainly within the production of stainless steel:

- electric arc furnace (EAF) filter dust;
- converter filter dust;
- all kinds of scale fines;
- shot blasting dust;
- grinding dust.

The chemical and the physical characteristics of these raw materials vary considerably, but typical contents are shown in Table 8.3.

Table 8.3: Typical amounts of metal oxides in secondary raw materials

Element	Content (%)
Cr ₂ O ₃	10–25
NiO	2–15
MoO ₃	0–5
Fe ₂ O ₃	30–65
CaO	1–30
Al ₂ O ₃	0.5–4
SiO ₂	1–15
MgO	1–5
ZnO	1–20
PbO	0.2–1
CdO	0.001–0.05
CuO	0.1–3
S	0.2–0.5
Cl	0.1–1
F	0–3
Hg	0–15 ppm

The residues are mostly oxidised materials with a smaller, variable fraction of metals. The metallic fraction comes mostly from surface treatment operations such as grinding, shot blasting, etc. The grain size of the raw material is typically between 1.0 µm and 30 µm and some materials are agglomerated and compacted.

The moisture content in the raw material might vary between 0 % and 35 % due to different gas-cleaning or other separation steps installed at the steel mills. This requires, to a certain extent, flexible handling and the use of conveying equipment, as well as drying equipment.

Owing to the various sources and qualities of residues, the economic viability of the activity requires a minimum content of alloying elements: nickel, chromium and if it can be used, molybdenum. Residues from the manufacture of austenitic (18-8 or better) stainless steel offer an appropriate content of typically > 3 % nickel and > 12 % chromium, while a large proportion of residues from ferritic stainless steel production (17 % chromium) are still dumped for processing cost reasons.

The product range of a single steelworks mainly influences the composition of the waste products by the technology employed and by the raw materials fed. Two major issues in this regard are the amount of lime in the filter dust and its zinc content. The lime content is mainly influenced by the different operations in the steel plant and the quality of the lime itself. The quality of the lime, i.e. its proportion of fines, influences the total quantity of lime present in the filter dust. The zinc content in the filter dust and other metals, e.g. lead, cadmium and mercury, is mainly dependent on the quality of the scrap feed for the electric arc furnace. If there is a high proportion of scrap feed that contains galvanised scrap, the entire zinc content is collected in the steel mill filter dust.

PCDD/F may be present in the furnace filter dust. The presence and the quantity of PCDD/F are dependent on the quality of the scrap feed in the stainless steel melt shops and the manner in which the off-gas is treated. Plastic impurities (chlorine compounds) support the formation of PCDD/F in the filter dust.

Other oxidised secondary raw materials are generated by other industries. Depending on the extent to which their composition is compatible with the metal requirements, they may be added to the mix. In this category are dust from foundries, Mo- and Ni-based spent catalysts, etc.

The quantity of raw material necessary to produce ferro-alloys varies considerably due to the differing metal contents in the feed. Typically, reclamation produces 400–600 kg of metal per tonne of dry raw material.

8.1.11.2 Preprocessing

Due to the presence of various undesired coarse elements in the raw material, e.g. filter masks, scrap pieces and refractories, it is necessary to screen the raw materials. The raw material can be delivered in big bags or in bulk. The big bags are emptied in an enclosure that is equipped with separate dedusting equipment. The dry raw material is then conveyed to a vibrating screen where foreign elements are removed. After this step, the material is conveyed to a silo group, which is used as a buffer silo prior to the mixing step.

When using the submerged arc furnace, the free lime contained in the raw materials is neutralised with water in a specific mixer prior to agglomeration by briquetting. After curing under cover, the briquettes are mixed with other charge ingredients and fed to the furnace.

8.1.11.2.1 Mixing and drying (plasma dust process only)

After screening, the slag-forming agents in the raw materials are analysed in order to determine the quantity of additions (sand, lime) required to balance the composition of the slag. The necessary amount of slag-formers are added, predominantly silica sand together with approximately 1–10 % water, in a high-turbulence batch mixer in order to obtain enough free-flowing micropellets. The consumption of silica sand is dependent on the basicity of the raw material. However, it is typically in the range of 0–100 kg/tonne of dry raw material.

The aim of drying the material is to obtain a homogeneous dry feed that can be sent pneumatically to the furnace building. The indirect rotating dryer used for this purpose is heated with CO-rich process gas. The dryer is equipped with a combined gas and oil burner. After drying, the material leaves the dryer at less than 100 °C. The material is screened again before it is conveyed to an intermediate silo.

A filter unit is used where the mercury emissions are monitored continuously on-line. Before entering the dryer, a small amount of Na₂S is added to the material to form stable mercury compounds, in order to prevent the evaporation of mercury.

8.1.11.3 Submerged arc furnace process

The recovery process that uses a submerged electric arc furnace is very similar to the production of ferro-chrome in an electric arc furnace. One installation in the US employs a rotary hearth furnace for the pre-reduction, followed by melting in a submerged arc furnace.

The furnace off-gas is dry-filtered in a conventional fabric filter. The gas is diluted by the ambient air in the open-top furnace where the combustion of CO is complete. Typical composition is 90 % air (18–20 % excess O₂), 7 % CO₂, and 3 % H₂O.

Off-gas cleaning is done in a two-stage bag filter. After cooling to below 200 °C, furnace dust is separated in the first stage and collected for recycling or processing for shipment. The dust is highly concentrated in zinc and can be further processed in a Waelz kiln prior to its use as feed for zinc production. In the second stage, adsorbent granules (activated carbon or lignite coke) are injected. Volatile metals, notably mercury and to a lesser extent cadmium and lead, are chemisorbed on the surface of the carbon. The absorbent also traps chlorine compounds including PCDD/F. This second stage operates below 130 °C. The same fabric filter collects the fumes from the tapping process.

A limited amount of water is injected and vaporised in the off-gases for temperature control. Process and cooling water are circulated in a closed circuit, the net water consumption is released as steam in the furnace flue-gases and by evaporative coolers.

Therefore, the process does not produce liquid effluents. About 60 % of the water consumption is covered by the collection of rainwater falling on the industrial site (ground and buildings).

The liquid slag is separated from the metal by gravity. The use of multiple cascades affords virtually complete separation. The low basicity of slag (0.7–0.8) ensures the formation of stable silicates which are non-leaching. Prior to shipment, chemical composition and leaching tests are performed to qualify each production load. The slag is used in various construction applications after the appropriate downsizing.

The alloy is cast in iron moulds. The pigs weigh 2–4 tonnes each. The free-flowing slag is collected in an open pit where it solidifies. After the solidification of the metal, the ingots are broken into a few large pieces with a hydraulic hammer in order to facilitate shipment and remelting. Because of its nickel content, the metal is relatively tough (not brittle), in contrast to most ferro-alloys. It requires no further processing and is suitable for bulk transport by truck or rail cars.

8.1.11.4 Plasma dust process

After the preprocessing steps described above, the raw material is pneumatically transported from the raw material preparation building to the furnace building, [233, COM 2008]

Smelting takes place in a shaft furnace comprising a 12-metre-high water-cooled shell with an inner diameter of approximately 2.5 metres. The furnace is equipped with three plasma generators providing an installed plasma heating effect of 21 MW_{th}. The shaft is filled with lump coke, which acts as a reducing agent. The plasma generators are symmetrically placed around the lower part of the furnace to supply the energy required for the endothermic reactions. The recirculated process gas is led to the furnace through water-cooled copper tuyères. The raw material is injected through tuyères and mixed with the plasma gas (approximately 4000–5000 °C) in the raceway where the reactions take place.

Coke is charged from the top of the furnace at regular intervals. The coke column acts as a reducing agent and filter for the gas being led out of the furnace. Due to the equal heat distribution in the furnace and its height, a high yield can be achieved in terms of the reduction of the valuable elements Ni, Cr, Mo and Fe and a comparatively low carry-over into the gas-cleaning step. Before tapping is carried out, raw material is injected into the shaft. At regular intervals, the furnace is tapped by drilling a hole at the bottom of the furnace, similar to the procedure with blast furnaces. The hot metal is cast at a temperature of approximately 1400 °C into casting beds lined with refractory material, to pigs of 3–4 tonnes each. This corresponds to a 40–60 % metal yield. The alloy is enriched with carbon (4–6 %) and can be granulated in a water bath which benefits handling and transportation, or crushed into pieces of approximately 500–800 kg, depending on the requirements of the end-users in the various steel mills.

Emissions to air come from channelled emissions and from diffuse sources. The process gas is cooled and cleaned in a three-stage Venturi scrubber system, followed by a wet ESP. Process gas that is not recycled to the shaft furnace is treated in a mercury filter unit (selenium filter). The cleaned gas is combusted/used in the drying of raw materials, in water boilers, or for energy delivery to the communal remote heating network, or is flared (excess gas). The raw material dryer system exhaust gases are cleaned in two bag filters. About 50 % of this energy for the district heating system is produced by direct heat exchange of cooling water from the furnace, the other 50 % is produced in a hot water boiler. About 50 % of the process gas is recirculated into the plasma generators through a compressor and used as heat transfer gas. The mercury emissions in the gas stream after the flare are measured continuously on-line [233, COM 2008]

The filter cake from the scrubber is highly concentrated in zinc and can be further processed in a Waelz kiln prior to its use as feed for zinc production.

The slag is separated from the metal by gravity and skimming the slag from the metal. The inert slag flows into a pit where it is regularly dug out and crushed at the same time. The slag can also be granulated. Then, the slag is separated externally from metal pieces. Based on experience, the basicity is approximately 1.0 (CaO , SiO_2), meaning that this kind of slag product can be sold as a non-leachable material for road construction. Long-term large-scale leaching tests have been carried out, in which slag was exposed to rainwater for 1.5 years. Slag has proven to be a suitable material for road construction purposes due to its very low leachability of metals and characteristics similar to those of natural mineral rocks.

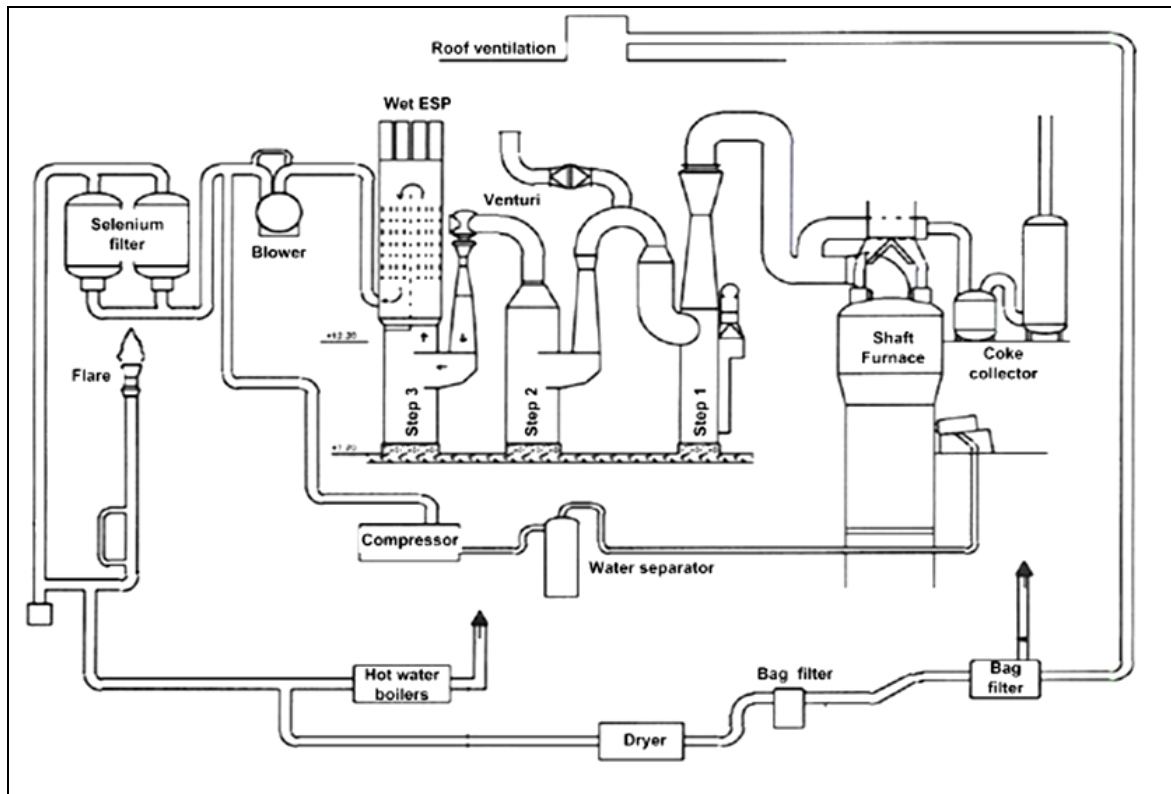

Figure 8.18: Plasma dust processing smelter (Sweden)

8.1.12 Summary of the smelting systems used in the ferro-alloy industry

Table 8.4: Summary of the smelting systems used in the ferro-alloy industry

Smelting system	Production	Gas collection and abatement	Advantages	Disadvantages
Open submerged electric arc furnace with three electrodes	FeCr, FeMn, SiMn, FeSi, FeNi, FeV, Si metal alloy recovery	Hooded and cleaned in a fabric filter	<ul style="list-style-type: none"> Robust, simple design Low investment and maintenance costs Can use almost any raw material and can perform pre-reduction Remelting and reuse of the furnace dust The smelting process can be easily controlled Hot water production 	<ul style="list-style-type: none"> High electrical energy consumption No heat recovery except hot water production Large off-gas volumes Need for large pollution control systems Higher environmental impact due to the off-gas volume and the heat supplied to the ambient air Formation of Cr(VI) when FeCr is produced
Open submerged arc furnace with a single electrode	Special ferro-alloys, FeV, FeB	Hooded and cleaned in a fabric filter	<ul style="list-style-type: none"> Robust, simple design High flexibility in production Low investment and maintenance costs Can use almost any raw material Can remelt fines and perform pre-reduction 	<ul style="list-style-type: none"> The open furnace with a single electrode is normally used in the production of special alloys for small quantities. The aforementioned disadvantage is therefore relatively lower
Semi-closed submerged arc furnace	FeCr, FeMn, SiMn, FeNi FeSi, Si metal alloy recovery, special ferro-alloys	Hooded and cleaned in a fabric filter	<ul style="list-style-type: none"> More flexibility in raw materials Energy recovery as electrical energy and/or steam Hot water production Smaller off-gas filter plant Easy control of the smelting process Reduced environmental impact 	<ul style="list-style-type: none"> Relatively high energy consumption if no pre-reduction More complex system Higher maintenance costs Can use a limited amount of fines without agglomeration Formation of Cr(VI) when FeCr is produced
Closed submerged arc furnace	FeCr, FeMn, Si Mn, FeNi, special ferro-alloys	Sealed furnace with wet scrubber or a dry wire-cloth filter	<ul style="list-style-type: none"> Low environmental impact Energy recovery in the form of CO-rich gas as a secondary fuel Low off-gas volume Fairly simple system 	<ul style="list-style-type: none"> Need for well-sized lumpy or agglomerated raw materials Off-gas consists of CO (explosive and poisonous) Wet gas cleaning system Waste water and sludge need to be treated or reused
Closed submerged arc furnace with preheating in a rotary kiln	FeCr	Sealed furnace with a wet scrubber	<ul style="list-style-type: none"> Low electrical energy consumption Energy-efficient Low environmental impact Increased furnace capacity 	<ul style="list-style-type: none"> Need for stricter amounts of well-sized hard lumpy ore or concentrates have to be agglomerated Agglomeration or pelletising plant Higher investment costs Little flexibility in the choice of raw material Complex system Wet gas cleaning system
Closed submerged arc furnace with a preheating shaft furnace	FeCr	Sealed furnace with a wet scrubber	<ul style="list-style-type: none"> More flexibility in raw materials Low energy consumption Energy recovery Low environmental impact Increased productivity of the furnace 	<ul style="list-style-type: none"> Need for well-sized hard lumpy ore or agglomerated raw material Wet gas cleaning system

Smelting system	Production	Gas collection and abatement	Advantages	Disadvantages
Closed submerged arc furnace with pre-reduction in a rotary kiln	FeCr	Sealed furnace with a wet scrubber	<ul style="list-style-type: none"> • Very low electrical energy consumption • Heat recovery, full utilisation of off-gases • Higher coal consumption, lower coke consumption • Increased productivity of the furnace 	<ul style="list-style-type: none"> • Higher investment costs • Wet gas cleaning system • Very complex system • No flexibility in raw material supply • Relatively high maintenance cost • Possibility of accretion formation
Plasma arc furnace	FeCr	Sealed furnace	<ul style="list-style-type: none"> • Possibility to use any ore except lumpy ore • Use of fines without agglomeration • Energy recovery • Use of coal instead of coke 	<ul style="list-style-type: none"> • Higher investment costs • High energy consumption • Complex system • Shorter operating time • CO in a pressurised system
DC furnace	FeCr	Sealed furnace	<ul style="list-style-type: none"> • Lumpy ore cannot be used • Use of fines without agglomeration • Low investment costs • Higher energy density 	<ul style="list-style-type: none"> • Injection with unknown difficulties • Problems with the bottom electrode when overheated • Need for prebaked electrodes
Refractory-lined crucible	Special ferro-alloys, FeMo, FeV	Hooded and cleaned in a fabric filter	<ul style="list-style-type: none"> • Low investment costs • High flexibility in production 	<ul style="list-style-type: none"> • Higher off-gas volume • Less effective gas collection system
		Enclosed in a reaction chamber connected to a fabric filter	<ul style="list-style-type: none"> • Low investment costs • High flexibility in production • Effective fume collection system • Lower off-gas volume 	<ul style="list-style-type: none"> • Slightly higher investment costs
Multiple hearth furnace	Molybdenite roasting	Wet scrubber	<ul style="list-style-type: none"> • Proven technology • Sulphuric acid can be produced 	<ul style="list-style-type: none"> • NA
Plasma dust process	Ferro-alloys recovery	Sealed furnace	<ul style="list-style-type: none"> • Use of fines without agglomeration • Energy recovery • High energy density • High flexibility in production 	<ul style="list-style-type: none"> • Higher investment costs • High energy consumption • Complex system • CO in a pressurised system • Wet gas cleaning system
<p>NB: NA= not available The use of open furnaces for producing FeCr is limited by the production of Cr(VI). For Mn and FeMn, a mercury removal stage should be incorporated. These are described in detail in Chapter 2. Source: [405, Euroalliances 2012]</p>				

8.2 Current emission and consumption levels

The production of ferro-alloys generates mainly dust and solid waste/by-products, and consumes a considerable amount of energy. When abatement techniques are applied to reduce emissions, cross-media effects occur. Generally, Sections 8.2.1 to 8.2.6 describe the most relevant environmental issues in ferro-alloy production processes.

Consumption of raw material and energy

- Raw material and energy consumption.

Emissions to air

- Dust and fume emissions including metals.
- SO₂, NO_x, CO gas, CO₂, polycyclic aromatic hydrocarbons (PAH), VOCs, PCDD/F and volatile metals.

Emissions of noise and vibrations

- Associated with machinery and releasing of skulls.

Solid residues, wastes and by-products

- Dust and sludge.
- Slag.

Waste water emissions

- Waste water from wet scrubbing systems.
- Waste water from the cooling of slag and the granulation of metals.
- Blowdown from cooling water cycles.

Energy recovery

- Energy recovery in terms of the utilisation of the CO-rich off-gas from closed furnaces.
- Energy recovery from the high-temperature off-gas either as electrical energy or hot water for heating purposes.
- Energy recovery from cooling water.

8.2.1 Consumption of raw material and energy

The raw material consumption mainly depends on the metal content of the ore or concentrate, the metal yield in the furnace process, the composition of the product and losses during raw material and product handling (transport, screening, etc.) and treatment (refining, solidification, crushing, packing, etc.). Higher yields result in a lower consumption of raw materials and energy per tonne of metal for a specific process. The production of special alloys may require cleaner raw materials that have less favourable process properties, giving a low yield and with a higher consumption of raw materials and energy per tonne of metal produced.

The energy consumption per tonne of metal differs greatly from one ferro-alloy to another. One reason is the difference in the chemical bonding strengths to oxygen for different elements in the ore and the temperature required for the chemical reactions to proceed. Silicon, for instance, has both a higher bonding energy and requires higher process temperatures than manganese. Other reasons are variations in the metal content of the ore or concentrate and the final product, and the metal yield that it is possible to obtain for different ferro-alloys. The latter is mostly governed by the amount of slag that is produced per tonne of metal and the amount of metal fume contained in the gases present in the production furnace at different temperatures.

The raw material and energy consumption figures listed in this section are for producing 1 tonne of tapped liquid metal. As an example, standard ferro-silicon can be tapped directly into moulds filled with low-value fines from previously crushed metal, adding several percentages to the

tapped tonnage. This gives low raw material and energy consumption values per tonne of product sold. The production of high-purity low-titanium ferro-silicon, on the other hand, requires extremely clean raw materials with less favourable process properties and post-taphole refining, often involving the use of both a tapping ladle and a refining ladle. The poorer raw materials give less silicon yield in the furnace process, while the post-taphole treatment results in substantial losses through oxidation of elements to be removed by refining, imperfect slag-metal separation and through metal that solidifies in the ladles used. The raw material and energy consumption levels per tonne of product sold are therefore much higher for this quality. The consumption values are given as intervals covering normal variations in the metal yield.

The latent chemical combustion energy of the free carbon in the carbon materials is listed even though this carbon is used as a reducing agent for the ore in highly energy-consuming chemical reactions rather than for energy production by combustion with oxygen. The substantial amount of volatile components in coal cannot, for instance, be used in the silicon metal and ferro-silicon process since they do not react with the ore. Nor does it add any energy in parts of the furnace where energy is needed. The energy consumption in ferro-alloy production is therefore always given by the amount of electrical energy used per tonne of tapped metal. The values in the tables are for the metal production process only and do not include auxiliary energy for operating various support systems like fans, heat exchangers, raw material handling, keeping ladles warm, etc. The auxiliary power normally amounts to between 5 % and 10 % of the values given in Table 8.5, Table 8.6, Table 8.7, Table 8.8, Table 8.9 and

Table 8.10.

To avoid false differences between process alternatives, it is important to present only the gross energy consumption. The energy sources going into the production process consist of electrical energy and latent chemical energy in the carbonaceous material. One kg of carbon has a potential gross energy content on conversion to CO₂ of approximately 8.8 kWh, or approximately 7.7 kWh/kg of coke. If these figures are used, the gross consumption of energy for the production of bulk ferro-alloys can be calculated. The gross amount of CO₂ emitted will be directly proportional to the amount of coke consumed in the process. Auxiliaries consumption is not included in the figures of the following tables. The auxiliary power normally amounts to between 5 % and 10 % of the values shown.

Table 8.5: Gross consumption data for the production of ferro-chrome as specific input of raw materials per tonne of alloy produced

Raw material	HC FeCr				LC FeCr
Chromite (kg/t)	2400–3000 ⁽¹⁾	2300–2400 ⁽²⁾	NA	NA	1600
Reducing agent (kg/t)	550–700 ⁽¹⁾	500–550 ⁽²⁾	600 ⁽³⁾	NA	675 (FeSiCr)
Fluxes (kg/t)	100–400 ⁽¹⁾	200–300 ⁽²⁾	NA	NA	1100
Others (kg/t)	Electrode 8–25 Remelts 0–300	Electrode 7–10	NA	NA	Sand < 100 kg Si < 40 kg Electrode 10 kg Boric acid 3kg
Electricity (kWh/t)	3800–4500 ⁽¹⁾	3100–3500 ⁽²⁾	2600–3100 ⁽³⁾	4500 ⁽⁴⁾	3400 ⁽⁵⁾
Potential energy by using coke (kWh/t)	4235–5390 ⁽¹⁾	3850–4235 ⁽²⁾	4620 ⁽³⁾	NA	NR
Total energy input (kWh/t)	8035–9890 ⁽¹⁾	6950–7735 ⁽²⁾	7220–7720 ⁽³⁾	NA	3400
<p>⁽¹⁾ Consumption data of a conventional open submerged arc furnace, lumpy and fine ore without agglomeration, preheating and/or pre-reduction processes.</p> <p>⁽²⁾ Consumption data for using preheated pellets as raw material and no remelts.</p> <p>⁽³⁾ Consumption data for using pre-reduced pellets as raw material. In this case, the energy consumption is dependent on the grade of metallisation.</p> <p>⁽⁴⁾ DC furnace without pre-reduction process.</p> <p>⁽⁵⁾ The energy consumption presented refers to the conversion of FeSiCr to LC FeCr. If the production of the intermediate product - FeSiCr - is included, the electrical energy consumption is 8050–9500 kWh/t, the potential energy consumption by using coke 5750–6400 kWh/t and the total energy input 13 800–15 900 kWh/t.</p> <p>NB: The aforementioned electricity and reducing agent consumption are for the whole production process. The electrical energy consumption is about 95 % of the total consumption. Most of the remaining 5 % is electrical energy needed for the off-gas treatment.</p> <p>NA = Not available. NR = Not relevant. Source: [226, Nordic Report 2008]</p>					

Generally, a higher chromium content in the alloy requires more energy for production. Coke breeze consumption will generally be in the range of 60–90 kg per tonne of sinter. With sinter consumption of 2–2.5 tonnes per tonne of ferro-chrome, this equals 120–225 kg of breeze per tonne of ferro-chrome. The external energy consumption of a steel belt sinter furnace ranges between 200 kWh and 400 kWh per tonne of pellets. The energy comes from coke breeze and CO gas from smelting. The coke breeze consumption is 20–40 kg per tonne of pellets and the proportion of CO as external energy is about 20–40 %. The external energy for coke drying in a shaft furnace is about 200 kWh per tonne of coke, equalling 100 kWh per tonne of FeCr.

The consumption of Söderberg electrode paste ranges between 8 kg and 25 kg per tonne of FeCr, the lowest consumption being achieved when using preheated or pre-reduced and agglomerated charge.

Water is used in the production of ferro-chrome both as process water and cooling water. Process water is used for scrubbing and slag granulation. If the process water treatment is in a closed circuit, 3–10 m³ per tonne of ferro-chrome is normally used. For cooling purposes, 5–15 m³ per tonne of ferro-chrome is also used.

Oxidised steel mill waste, dust and scale are recovered using processes adapted from high-carbon ferro-chrome production. The energy consumption for the metallurgical reduction is shown in Table 8.6 for typical contents of recoverable metals. Two types of furnaces are in use, conventional submerged arc furnaces and DC plasma shaft furnaces.

Table 8.6: Consumption data for the recovery of ferro-alloys from steel mill residues as specific input of raw materials per tonne of recovered metal

Component	Conventional submerged electric arc furnace	Plasma dust process
Residues (kg/t)	1650–2500	1650–2500
Reducing agent (kg/t)	400–500	400–500
Electricity (kWh/t)	3000–3400	2800–3800
Metal contents (output):	(%)	(%)
Ni	3–15	3–15
Cr	15–25	15–25
Mo	1–5	1–5
C	4–6	4–6
Si	0.5–8	0.1–1
Fe	Balance	Balance
Water (m ³ /t)	1.0–1.5	2.8–3.2
Alloy recovery (output):	(%)	(%)
Cr	90–95	90–95
Ni	90–98	90–98
Mo	90–98	90–98
Fe	90–98	90–98
<i>Source: [226, Nordic Report 2008]</i>		

The consumption of energy and raw material for the production of ferro-silicon, silicon metal and silico-calcium are presented in terms of specific input factors in Table 8.7. The amount of electrical energy that is given is for the furnace process only and refers to 1 tonne of liquid metal tapped from the furnace at the specified silicon yield, electrical efficiency of the furnace and carbon loss from the top of the furnace.

Table 8.7: Consumption data for the production of ferro-silicon, silicon and silico-calcium as specific input of raw materials per tonne of alloy produced

	Ferro-silicon (75 % Si)	Silicon metal	Silico-calcium
Quartzite (kg/t)	1800	2700	1500
Reducing agent (kg/t)	1100–1200	1150–1500	925
Electrode (kg/t)	40	100 ⁽¹⁾	120
Iron ore pellets (kg/t)	300–350	NR	NR
Limestone (kg/t)	NR	NR	900
Woodchips (kg/t)	0–900	1000–2000	NR
Electricity (kWh/t)	9000	10 800–12 000 ⁽²⁾	9500
Potential energy assuming coke or coal is used (kWh/t)	10 500 (coke/coal)	10 120–13 200 (coal)	7122 (coke)
Total energy input (kWh/t)	19 250	20 920–25 200	16622
⁽¹⁾ Some silicon producers are using a combined Söderberg-graphite electrode. The aim is to use the Söderberg technology but reduce the iron impurities caused by the electrode casing.			
⁽²⁾ The ideal energy consumption for the production of silicon metal is 10 100 kWh/t (heat of reaction = 8 kWh/t, heat loss with the metal = 0.9 kWh/t and heat loss in the off-gas = 1.2 kWh/t).			
NB: NR = Not relevant.			
<i>Source: [226, Nordic Report 2008]</i>			

A combination of the Söderberg technology and a graphite core is used for the production of silicon metal. The aim of this compound electrode is to reduce the cost of the electrode, whilst keeping the iron impurities caused by the electrode casing at an acceptable level for the silicon metal.

The specific input factors for the production of the different sorts of ferro-manganese as well as for silico-manganese and the sinter process of manganese ores and concentrates are given in Table 8.8 below.

Table 8.8: Consumption data for the production of manganese ore sinter, ferro-manganese and silico-manganese as specific input of raw materials per tonne of alloy produced

Source	Sinter	HC FeMn	MC/LC FeMn (silicothermic)	MC/LC FeMn (decarburisation process)	SiMn (standard and LC SiMn)
		EAF			
Ore ⁽¹⁾ (kg/t)	1000–1300	1900–2400	1000–2000	2200–2800	500–2000
Coke or coal (kg/t)	100	410–500	200–300	480–580	400–700
Gas (m ³ /t)	150–200	NR	NA	NR	NR
Electrode (kg/t)	NR	8–30	6–8	9–29	10–50
Water ⁽²⁾ (m ³ /t)	12–18	1.5–40 ⁽³⁾ cooling water	Cooling water	2–50 ⁽³⁾	1.5–40 ⁽³⁾ cooling water
Others (kg/t)	NR	NR	Fluxes 500–1000 SiMn 700–1000	Oxygen 60–100 m ³ /t	FeMn slag 400–2500
SiMn (kg/t)	NA	NA	500–1200	NA	NA
Electricity (kWh/t)	100	2200–3200	1400–2000	2600–3700	3800–6000
Potential energy by using coke (kWh/t)	900–1000	3800–4100	5700–13 300	4400–4800	3100–5000
Total energy input (kWh/t)	1000–1100	6000–7300	7300–15 300	7000–8500	6900–11 000
⁽¹⁾ The raw materials consumed normally contain recycled materials such as dusts and sludges from the abatement system. ⁽²⁾ The consumption of water is dependent on the water processing equipment and varies from 20 m ³ /t to 40 m ³ /t in open circuits and from 1.5 m ³ /t to 5 m ³ /t in closed circuits. ⁽³⁾ Water consumption is associated with wet dedusting. NB: Silicon can be replaced by aluminium. EAF = Electric arc furnace. NA = Not available. NR = Not relevant. Source: [226, Nordic Report 2008] [370, France 2009]					

The specific input factors for the production of ferro-nickel are given in Table 8.9 below.

Table 8.9: Consumption data for the production of ferro-nickel alloy as specific input of raw materials per tonne of alloy produced

Source	FeNi alloy (~ 20 % Ni)
Ore (t/t)	20
Coke or coal (t/t)	4
Gas (m ³ /t)	0.006
Electrode (t/t)	0.048
Others (crude oil, limestone, cement) (kg/t)	0.57
Electricity (MWh/t)	10
<i>Source: [406, Greece 2013]</i>	

The available information on the consumption of raw material and energy for the production of various special ferro-alloys is presented in

Table 8.10.

Table 8.10: Consumption data for the production of special ferro-alloys as specific input of raw materials per tonne of alloy produced

Component	FeV	FeMo ⁽¹⁾	FeTi	FeB
Metal oxides (kg/t)	1100–2000 ⁽²⁾	NA	NA	NA
Electricity (kWh/t)	2200–2800	160–405	770	6000–11 000
Gas (m ³ /t)	NR	148–155 MJ/t	55	75
Water (m ³ /t)	NA ⁽³⁾	NR	NM	0.3
⁽¹⁾ The consumption data for the production of FeMo are based on one tonne of molybdenum. ⁽²⁾ The data presented contain the amount of V ₂ O ₃ and V ₂ O ₅ . ⁽³⁾ The consumption of water is very site-specific and therefore not representative. NB: NA = Not available. NR = Not relevant in this production process. NM = Not measured. <i>Source: [226, Nordic Report 2008]</i>				

The process of roasting molybdenite concentrates is an exothermic process as the oxidation reaction is ignited. External energy in the form of electricity will therefore only be needed for the mechanical operation of the multiple hearth furnaces. Natural gas is used to dry the concentrates and to ignite flotation oil and elevate the temperature to the point at which the exothermic reactions are triggered and the remaining sulphur removed.

8.2.2 Emissions to air

8.2.2.1 Dust and fume emissions

Depending on the raw material that is needed and the unit operations used, e.g. crushing, drying, sintering, reduction, tapping and product handling, the most important sources of environmental emissions are dust and fumes. Figure 8.19 shows the potential emission points for dust and fumes from a ferro-alloy production plant. The main sources of diffuse emissions are raw material handling from quay to storage bin, raw material transport from storage bins to the reduction furnace, furnace processes, tapping, metal transport and refining processes, casting processes and crushing, screening and packing.

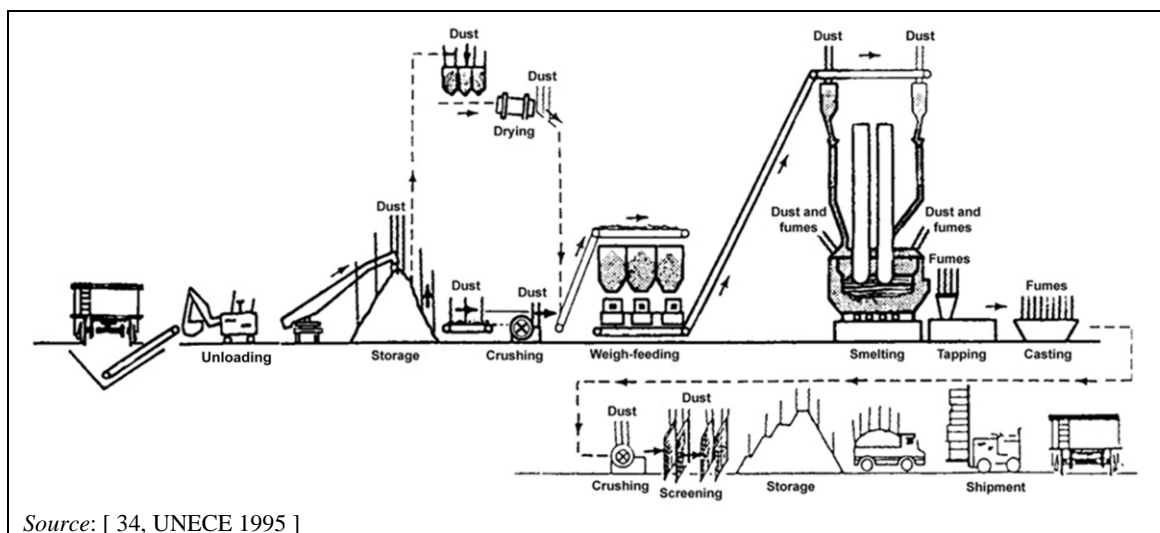

Source: [34, UNECE 1995]

Figure 8.19: Ferro-alloy production flow diagram showing potential points of emissions to air

Some raw materials contain a considerable amount of fines and dust. The unloading and storage of raw material can generate dust when the material falls from one conveyor to another. Dust can also be produced if the conveyor is running too fast (i.e. more than 3.5 m/s). If a front-end loader is used, dust is emitted during the whole journey.

Dust that is produced by the reduction process is collected by hoods or, for a closed furnace, by the furnace sealing itself, and transferred to an abatement plant and dedusted. The dedusting of closed furnace off-gases is generally achieved with wet scrubbers or dry cleaning systems, while bag filters can be used for open and semi-closed furnaces. Typically, by using a closed, sealed furnace, the volume of the off-gas can be reduced by a factor of 50–75, and by a factor of 10–20 by using a semi-closed furnace. The investment costs for the off-gas cleaning systems for closed furnaces are much lower than for open furnaces.

Tapping off-gas consists of dust and fumes from the furnace process and oxygen lancing, dust from drilling, fumes from vaporised slugs if a tapping gun is used and fumes from all exposed metal and slag surfaces. These fumes that arise from tapping contain little CO or CO₂ but will mainly be oxides of the metals involved in the reduction process.

Table 8.11, Table 8.12, Table 8.13 and Table 8.14 present the available emission data for the emissions of dust when producing different ferro-alloys.

Table 8.11: Dust emissions from the production of ferro-chrome based on the production of one tonne of alloy

Source	HC FeCr		MC FeCr		LC FeCr	
	(kg/t)	(mg/Nm ³)	(kg/t)	(mg/Nm ³)	(kg/t)	(mg/Nm ³)
Raw material handling	0.01–0.02	f ⁽¹⁾	NA	f ⁽¹⁾	f ⁽¹⁾	
Drying	0.01–0.02 (coke)	1–50	NA	NA	0.082 (ore)	5
Crushing	0.002	NA	NA	NA	0.003	3
Pelletising/sintering ⁽²⁾	0.01–0.02 /t pellets	1–15	NR	NR	NR	NR
Dosing station	0.01–0.02	1–30 ⁽²⁾	NA	NA	0.024	5
Preheating	0.001–0.005	1–15 ⁽²⁾	NR	NR	NR	NR
Smelting furnace	0.02–0.1 ⁽³⁾	1–100 ⁽²⁾⁽⁴⁾⁽⁵⁾	NA	NA	0.101	8
Tapping	⁽⁶⁾	5–12 ⁽²⁾	NA	NA	⁽⁷⁾	⁽⁷⁾
Casting	⁽⁶⁾	5–12 ⁽⁶⁾	NA	NA	0.2–0.4 ⁽²⁾	3–15 ⁽²⁾
Slag handling	NM	NM	NA	NA	0.04	10–15
Product handling (crushing, screening, storage, etc.)	0.02–0.05	r	NA	NA	NA	NA

⁽¹⁾ The material loss caused by handling and storage of raw material is estimated to be less than 1 %.

⁽²⁾ The dust emissions presented are dependent on the furnace type and the off-gas abatement technique used. For instance, most bag filters achieve less than 5 mg/Nm³. Dust emissions from a sinter furnace using a cascade wet scrubber are reported to be below 5 mg/Nm³.

⁽³⁾ The Cr(VI) content of the furnace dust is between 5 ppm and 100 ppm in the closed furnace and between 1000 ppm and 7000 ppm in the open furnace.

⁽⁴⁾ This illustrates the range between good and poor performers.

⁽⁵⁾ The furnace gas from a closed furnace is used as fuel after wet scrubbing. The gas is flared only if a customer is temporarily not available.

⁽⁶⁾ Sampling of the ventilation air leaving the furnace building, including the tapping and casting area, over long periods of time can give an indication of the average values. These show average dust concentrations of between 5 mg/Nm³ and 12 mg/Nm³.

⁽⁷⁾ The furnace gas from a closed furnace is used as fuel after wet scrubbing. The gas is flared only if a customer is temporarily not available.

⁽⁷⁾ Included in 'smelting furnace' source.

NB: NA = Not available. NR = Not relevant. NM = Not measured.

f = Diffuse dust emissions. r = Dust is recycled back into the process.

Source: [226, Nordic Report 2008]

Table 8.12: Dust emissions from the production of ferro-silicon and silicon metal based on the production of one tonne of alloy

Source	FeSi		Si and CaSi	
	(kg/t)	(mg/Nm ³)	(kg/t)	(mg/Nm ³)
Raw material handling	f ⁽²⁾	f ⁽²⁾	f ⁽²⁾	f ⁽²⁾
Drying of woodchips	NM	NM	NM	NM
Crushing	NM	NM	NM	NM
Weighing dosing station	f	f	f	f
Smelting	0.1–2	1–20 ⁽¹⁾	0.1–1.5	1–20 ⁽¹⁾
Tapping	⁽³⁾ (⁴)	⁽³⁾ 5–12 ⁽⁴⁾	⁽³⁾ (⁴)	⁽³⁾ 5–12 ⁽⁴⁾
Casting	⁽⁴⁾	5–12 ⁽⁴⁾	⁽⁴⁾	5–12 f ⁽⁴⁾
Refining	⁽³⁾	⁽³⁾	⁽³⁾	⁽³⁾
Product crushing	0.3–0.5	r	0.3–0.5	r

(¹) Using a bag filter, plants achieve dust emissions below 5 mg/Nm³, corresponding to a cleaning grade of above 99.5 %. The silica fume is collected in the filter as a by-product (micro-silica).

(²) The material loss caused by handling and storage of raw material is estimated to be around 0.2 %.

(³) If the fumes and dust from the tapping area are collected and cleaned in the bag filter the dust concentrations are in the same range as the concentration of dust emissions from the smelting furnace.

(⁴) Sampling of the ventilation air leaving the furnace building, including the tapping and casting area, over long periods of time can give an indication of the average values. These show average dust concentrations between 5 mg/Nm³ and 12 mg/Nm³ and total dust emissions amounting to 0.2–0.6 kg/tonne of alloy produced.

NB: NA = Not available. NR = Not relevant. NM = Not measured.
f = Diffuse dust emissions. r = Dust is recycled back into the process.

Source: [226, Nordic Report 2008]

Data provided by Norway indicate that sometimes a significant amount of channelled dust emissions bypasses the abatement system during the production of ferro-silicon and silicon metal. Reasons given for bypassing the abatement system are associated with excessively high temperatures (which could damage the bag) that may occur when irregularities in the furnace take place and during start-ups and shutdowns.

Table 8.13: Dust emissions from the production of ferro-manganese and silico-manganese based on the production of one tonne of alloy

Source	HC FeMn			MC and LC FeMn		SiMn	
	BF	EAF		(kg/t)	(mg/Nm ³)	(kg/t)	(mg/Nm ³)
		(kg/t)	(mg/Nm ³)				
Raw material handling	NR	f	f	f	f	f	< 0.1
Weighing dosing station	NR	NA	NA	NA	NA	NA	< 0.1
Smelting	NR	0.1–0.4	5–60 ⁽¹⁾	NA	< 25	0.02–0.4	5–60
Tapping	NR	NA	NA	NA	NA	NA	3.2
Casting	NR	0.05–0.1	NA	0.05–0.1	NA	NA	NA
Refining	NR	NA	NA	NA	NA	NA	NA
Product crushing	NR	0.1–0.3	r	0.1–0.3	r	NA	r
Waste heat boiler	NR	NR	NR	NR	NR	NR	NR
Electricity production	NR	NR	NR	NR	NR	NR	NR

⁽¹⁾ If the dedusting of the off-gases from a closed sealed furnace takes place in a cascaded wet scrubber dust emissions below 10–40 mg/Nm³ are achieved. Some plants that are operating semi-closed furnaces using bag filters for dedusting are achieving dust emissions below 5 mg/Nm³.
 NB: BF = Blast furnace. EAF = Electric arc furnace.
 NA = Not available. NR = Not relevant.
 f = Diffuse dust emissions. r = Dust is recycled back into the process.
 Source: [226, Nordic Report 2008]

Table 8.14: Dust emissions to air (after abatement) from the production of ferro-alloys

Source	Fe Ni (mg/Nm ³)	FeV (g/Nm ³)	FeMo (mg/Nm ³)	FeTi (mg/Nm ³)	FeB (mg/Nm ³)	Molybdenite roasting (mg/Nm ³)
Raw material handling	1–15	< 5	0.5–15	1–15	1–15	1–15
Raw material drying	1–15	NR	4–17	1–15	1–10	NR
Crushing	< 1 ⁽¹⁾	NR	1–5			NR
Pelletising		NR	NR			1–15
Sintering/roasting		NR	NA			1–15
Dosing		NR	1			NM
Preheating		NR	NR	NR		
Smelting	1–15	< 5	1–30	1–15	1–10	NR
Tipping/tapping	NA		5–15	NA	NA	NR
Casting			⁽²⁾	NA	NA	NR
Slag handling	NA	NA	NA	NA	NA	NR
Product crushing	1–15	< 5	0.5–5	NA	NA	NM

⁽¹⁾ Data are from the production of secondary FeNi where a modern membrane fabric filter is used. The result gives the amount of Ni oxide as part of the emitted dust from the rotary kiln.
⁽²⁾ Emissions are estimated from the roof exhaust fans.
 NB: NA = Not available. NR = Not relevant. NM = Not measured.
 Source: [226, Nordic Report 2008]

Table 8.15: Ferro-nickel emissions to air

Component smelter total	Measured concentration in stack emissions (mg/m ³)	Maximum airflow rates (Nm ³ /h)	Sampling frequency
Dust	113	1 200 000	4 times per year
Ni	1–1.551		
Co	0.078		
As	0.012		
Pb	0.049		
Cd	0.002		
Hydrocarbons	1322		
CO	3262		

Source: [356, ENIA 2008]

Table 8.16: Sources of ferro-nickel emissions

Source	Stack emission factor (g/tonne)	Abatement system
Rotary kilns	1993 (reference year: 2006)	ESP, multi-cyclones, Venturi scrubbers and bag filters
EAF	20 993 (reference year: 2006)	
Converter	315	

Source: [356, ENIA 2008]

Table 8.17 shows the measured data after dust abatement by bag filter from different sources when producing ferro-vanadium and ferro-molybdenum at one site.

Table 8.17: Emissions from the production of ferro-vanadium and ferro-molybdenum

Source	Off-gas flow (Nm ³ /h)	Dust (mg/Nm ³)	Tot. C (mg/Nm ³)	PAH ⁽¹⁾ (µg/Nm ³)	PCDD/F (ng I-TEQ/Nm ³)
Rolling scale drying	10 000	4.83	NR	NR	NR
Mo burden preparation	10 000	1.74	NR	NR	NR
5 EAF (FeV)	approx. 17 000 per furnace	1.36	1.7–3.3	23	0.00032–0.00044 PCDF 0.0011–0.0015 PCDD
Thermite oven (FeMo) (exothermic reaction)	19 411	1.43	2.3–3.8	35	0.0012–0.0014 PCDD 0.00015–0.0005 PCDF
Product crushing					
FeMo	9700	0.82	NR	NR	NR
FeV	11 800	0.91			
Slag crusher					
FeMo	1500	0.99	NR	NR	NR
FeV	25 000	2.80			
Refractory crushing	1400	1.03	NR	NR	NR
Packing	5400–8200	1.73	NR	NR	NR
Diffuse emissions via the roofline	225 700–314 300 ⁽²⁾	3.88	NR	NR	NR

(¹) 16 EPA PAH.
(²) The lower value represents the furnace out of operation and the higher value represents the furnace in operation.
NB: NR = Not relevant.
Source: [369, Treibacher Industries AG 2008]

8.2.2.2 Other emissions to air

The most important pollutants from the production of ferro-alloys besides dust are SO_2 , NO_x , CO, CO_2 , HF, polycyclic aromatic hydrocarbons (PAH), volatile organic compounds (VOCs) and metals. The formation of PCDD/F in the combustion zone and in the cooling part of the off-gas treatment system (de novo synthesis) may be possible in open or semi-closed furnaces. N_2O and CH_4 are emitted from sinter and pelletising plants. Mercury, if present in the ore, can also be emitted from reduction processes. The emissions can escape the process either as stack emissions or as diffuse emissions, depending on the design and maintenance of the plant and the technology used. Stack emissions are normally monitored continuously or periodically and reported by on-site staff or off-site consultants to the competent authorities.

In the carbothermic process, only the fixed carbon content is used as a reducing agent, which means that volatile matter, ashes and moisture mostly leave the furnace with the off-gas and slag. The volatile matter consists mainly of hydrocarbons and does not take part in the reaction but leaves the furnace together with the CO when the furnace is closed, or is burnt near the surface in a semi-closed or open furnace to produce CO_2 . Closed furnaces produce higher concentrations of CO that can be used as a fuel gas in other processes.

The sulphur content in metallurgical coke varies between 0.4 % and 1.0 %. Of this sulphur, 60–85 % remains in the slag and about 5 % escapes the furnace as SO_2 . The production of silicon alloys requires different reducing agents like coal, coke, petrol coke and charcoal. These reducing agents contain different amounts of sulphur, and typical variations are between 0.5 % and 3 %. Silicon alloy production is almost slag-free and nearly all sulphur escapes from the furnace as SO_2 or as sulphur bound to the micro-silica. By using a reducing agent or a mixture of different carbon sources, with in total a high sulphur content of about 2–3 %, higher SO_2 emissions may occur.

The off-gas generated by roasting molybdenite concentrates contains large amounts of SO_2 that are normally cleaned in a desulphurisation plant, producing sulphuric acid. The tail gas from the desulphurisation plant of a molybdenite roaster contains SO_2 , since the conversion of SO_2 into SO_3 will not be 100 %. The off-gas also contains a certain amount of sulphuric acid mist as well as some SO_3 .

Metals are carried into the process as trace elements in the raw material. The metals with a high enough vapour pressure will escape as gases in the form of metal vapour, which partly condenses and oxidises to form part of the dust from the smelting furnace. Even after tapping and especially during refining, the temperature of the molten metal and slag is high enough to allow vaporisation of components both from the metal and from the slag. The fumes arising from this evaporation evolve the whole time, from the start of tapping until casting is finished. Even after the ladle is emptied, some fumes may evolve from the metal skull. During tapping, most of the fumes are collected through the tapping fume collection system and cleaned.

Depending on the type of raw materials used, mercury could be emitted to the air by ferro-manganese or silico-manganese furnaces. This can be addressed either by controlling the mercury content in the raw materials, pretreating the raw materials in order to remove the mercury (for instance through sintering) or by treating the off-gas (several commercial technologies are available for mercury removal from off-gases, as reported in Section 2.12.5.5) [[226, Nordic Report 2008](#)].

Mercury removal from raw materials will involve large-scale equipment. Ore dressing is only economical due to scale. For the converting step, the cleaning of the off-gas might be feasible if a satisfactory gas collection system can be installed. Sintering plants are usually built for the treatment of ore fines. If the material must be sintered due to size, mercury removal should be installed. For alloy production, online measurement and cleaning measures must be at least a minimum requirement.

In the production of ferro-molybdenum, fluorspar may be used to improve slag and metal separation. Fluorspar is a calcium fluoride ore that is used as a flux and lowers the melting point and the viscosity of the slag, resulting in an enhanced fluidity of the slag. Additionally, when mixed with lime, it reduces the phosphorus and sulphur content of the metal. Lower melting points favour the metal-slag separation, since the slag remains liquid for a longer time during the cooling. This effect, together with the reduced viscosity, makes it possible for small dispersed droplets to sink and coagulate in the metal phase at the bottom. However, the use of fluorspar as a fluxing agent results in emissions of fluorides within the range of 150–260 mg/Nm³. Due to the biotoxic nature of fluoride, the use of fluorspar should be minimised as far as possible. Table 8.18 and Table 8.19 present some figures of measured emissions to air when producing bulk ferro-alloys, however the data are not meant to be representative of the whole EU-28 industry.

Table 8.18: Emissions to air (after abatement) when producing bulk ferro-alloys

Component	FeCr				FeSi		Si metal		FeMn				Silico-manganese	
	HC FeCr		MC and LC FeCr						HC FeMn EAF		MC and LC FeMn			
	(kg/t)	(mg/Nm ³)	(kg/t)	(mg/Nm ³)	(kg/t)	(mg/Nm ³)	(kg/t)	(mg/Nm ³)	(kg/t)	(mg/Nm ³)	(kg/t)	(mg/Nm ³)	(kg/t)	(mg/Nm ³)
SO ₂	0.2–3.0	NA	NR	NR	0.5–5 ⁽¹⁾	< 450	12–18	< 450	0.1–0.2	NA	NA	NA	0.002–0.1	NA
CO	NM	NM	NM	NM	2.0–2.5	< 200	NM	< 200	NA	NA	NA	NA	NA	NA
CO ₂	1200–2000 ⁽²⁾	NA	110 ⁽³⁾	NA	5300 ⁽⁴⁾	93 g/Nm ³	7500 ⁽⁴⁾	125 g/Nm ³	1100–1800	NA	1800 ⁽⁵⁾	NA	1100–1800	NA
NO _x	0.5–1.5	NA	0.35	NM	10–11	400	10–13	< 500	NA	NA	NA	NA	NA	NA
HF	NM	NM	NM	NM	NM	NM	NM	NM	NA	NA	NA	NA	NA	NA
PCDD/F	< 0.1 ng/Nm ³	NA	NM	NM	40 ng/t ⁽⁶⁾	NA	40 ng/t ⁽⁶⁾	NA	NA	NA	NA	NA	NA	NA
Metals	Cr (in the dust) 1–15 % Cr(VI) 0.1–0.3 % ⁽⁷⁾	NA	Cr < 0.01 Cr ⁶⁺ < 0.002	NA	NA	1.0 µg Hg/Nm ³ ⁽⁶⁾	NA	1.0 µg Hg/Nm ³ ⁽⁶⁾	See Table 8.19					
PAH	NM	NM	NA	3–6 µg/Nm ³	0.0015 ⁽⁶⁾	70 µg/Nm ³	0.003 ⁽⁶⁾	0.02	NA	NA	NA	NA	NA	NA
VOCs	NM	NM	NA	NA	0.045 ⁽⁶⁾	100	0.13 ⁽⁶⁾	100	NA	NA	NA	NA	NA	NA
Cyanides	0.02–0.05	NA	NA	NM	NM	NM	NM	NA	NA	NA	NA	NA	NA	NA

⁽¹⁾ The high value corresponds to a production of high-purity FeSi in which a great quantity of petrol coke is used.

⁽²⁾ The emissions of CO₂ include total emissions from the pretreatment smelting and post-furnace processes. The external use of the CO gas from the smelting furnace reduces the local emissions from the FeCr plant only.

⁽³⁾ The emissions are due to 80 kg/t from the natural-gas-fired dryer, ladle heating, etc. and 30 kg/t from the electrode pastes that are consumed.

⁽⁴⁾ The CO₂ data contain the amount of fossil fuels as well as the amount of biological CO₂.

⁽⁵⁾ The CO₂ data are due to the silicothermic production of LC FeMn. The CO₂ emissions by producing MC FeMn from HC FeMn are about 100–500 kg/t of alloy.

⁽⁶⁾ Results from comprehensive 24-hour surveys of emissions to air from the production of FeSi 75 and high-purity Si metal. In this case, it should be noted that the data are based on relatively short measuring periods at two specific plants and should not be taken as representative of the industry.

⁽⁷⁾ The amount of Cr(VI) in the dust is emitted from a semi-closed furnace; cyanides account for 0.2–0.05 % from a closed furnace.

NB: NA = Not available. NR = Not relevant. NM = Not measured.

Source: [226, Nordic Report 2008], [373, Grådahl et al. 2007]

Table 8.19: Emission of metals from ferro-manganese and silico-manganese production

FeMn				
	HC FeMn		MC and LC FeMn	
	EAF			
	(kg/t)	(mg/Nm ³)		
SO ₂	0.1–0.2	NA	NA	
CO	NA	NA	NA	
CO ₂	1100–1800	NA	60–100	
NO _x	NA	NA	NA	
Hg	0.0001–0.00015	0.001–0.2		
Pb	0.0002–0.0004	NA		
As	2×10 ⁻⁵	NA		
Cd	5×10 ⁻⁶	NA		
Cr	2×10 ⁻⁵	NA		
Cu	8×10 ⁻⁵	NA		
Sum	0.0001	0.0002		
Emissions to air				
SiMn				
	(kg/t)	(mg/Nm ³)		
SO ₂	0.002–0.2	NA		
CO	NA			
CO ₂	1100–1800			
NO _x	NA			
Hg	0.00003–0.0007			
Pb	0.0002–0.0007			
As	2×10 ⁻⁵			
Cd	5×10 ⁻⁶ –10 ⁻⁴			
Cr	2×10 ⁻⁵ –10 ⁻³			
Cu	0.0001–0.0003			
Sum	0.0001		0.0002	

NB: NA = Not available.
Source: [233, COM 2008], [226, Nordic Report 2008] [395, France 2013]

The emissions to air when producing primary ferro-nickel are shown in Table 8.20 and Table 8.21.

Table 8.20: Emissions to air from primary ferro-nickel production

Component	FeNi	
	(kg/t)	(mg/Nm ³)
SO ₂	20–25	NA
CO ₂	45 000	NA
NO _x	10–15	NA
PCDD/F	NA	0.4 ng/Nm ³

NB: NA = Not available.
Source: [406, Greece 2013]

Table 8.21: Characterisation of the emissions to air from primary ferro-nickel production

Operation	Emissions to air						
	Dust/Fume			Gases			
	Total	Ni	Others	SO ₂	CO ₂	CO	NO _x
Ore crushing	HL	LL	NA	NA	NA	NA	NA
Drying	HL	HL	NA	LL	ML	LL	NA
Roasting	HL	HL	NA	HL	ML	LL	LL
Reductive calcination	HL	LL	NA	LL	ML	LL	LL
Smelting	HL	LL	NA	NA	ML	ML	LL
Converting	HL	ML	SiO ₂	NA	ML	LL	LL
Pouring	HL	LL	NA	NA	NA	NA	NA

NB: NA = Not applicable.
 LL = Low level. ML = Medium level. HL = High level.
Source: [226, Nordic Report 2008], [106, Raffinot, P. 1993]

Emissions from a process producing ferro-alloys are presented in Table 8.22. This process uses material recovered from steel mill residues in a submerged electric arc furnace. The percentage of metals in dust will dictate the concentration of metals.

Table 8.22: Emission from a secondary ferro-alloys production process

Pollutants	Concentrations (gas and particles) (mg/Nm ³)
Dust	2–5
SO ₂	< 100
CN	0.002–0.006
HC	< 50
F	0.1–1.5
Cd	< 0.001
Cd+Hg+Ti	< 0.1
As	< 0.003
Se	< 0.002
Te	< 0.002
Zn	2.0
Pb	0.2
CO ₂	1.2–1.5 t/t of alloy

Source: [226, Nordic Report 2008]

In the production of silicon and ferro-silicon, the combustion process in the smoke hood and off-gas channels may create emissions to air. The main problems are the formation of NO_x, PAH and PCDD/F. The preferred reporting convention is the EPA 16, as this is compatible with the PRTR reporting requirements.

8.2.3 Emissions of noise and vibrations

Heavy machinery, such as crushers and large fans, used in ferro-alloy production can give rise to emissions of noise and vibration. Also, the mechanical releasing of skulls from the ladles may be a source of noise.

8.2.4 Emissions to water

For the production of ferro-alloys, the emissions to water are very dependent on the process, for instance the abatement system and the type of waste water treatment used. A variety of different water collection and waste water treatment systems are used in the ferro-alloy industry. Some plants use a central waste water treatment plant in which water from different production processes and surface run-off water will be cleaned together. Other facilities use a separate treatment system for rainwater and special treatment processes for the different process waste water streams. The main water pollutants are suspended solids and metal compounds. The waste water is treated in order to remove dissolved metals and solids and is recycled or reused as much as possible in the process. The possible waste water streams are:

- surface run-off and drainage water;
- waste water from wet scrubbers;
- waste water from slag cooling and metal granulation;
- cooling water.

The contaminated water is normally led to a thickener or a settling pond to settle out the suspended solids. Precipitation steps are often used to remove metal compounds from the water. In special cases, for instance for cleaning scrubbing water from a molybdenite roasting furnace, ion exchangers are used to remove metal compounds such as selenium and rhenium from the scrubbing water.

The particles mostly consist of very fine particles, so it may therefore be necessary to add a flocculant to assist settling in thickeners. After the treatment in a thickener or a settling pond, the suspended solids are usually below 40 mg/litre, which allows the water's reuse in scrubbers as cooling water or as process water for other purposes.

If a thickener, slag granulation and settling ponds are used, emissions of suspended solids will correspondingly be 10–20 g with a total amount of chromium of about < 1 g, zinc < 2 g and cyanide in the range of < 1 g per tonne of FeCr. For the production of LC FeCr, it has been reported that the amount of chromium discharged in the waste water is < 1.0 g/tonne of product. PAH emissions to water after abatement for the production of ferro-manganese have been reported to be in the range of 0.05–0.2 g/t of FeMn.

The contaminated waste water of the scrubber system from an alloy recovery plant is cleaned in a separate waste water treatment plant in which rainwater from the site may also be cleaned. The partly oxidised particles contained in the water are concentrated in a thickener and, in a later step, separated from free water in two filter presses. The resulting filter cake with 20–25 % moisture consists of the following main constituents:

- ZnO: 30–40 %;
- SiO₂: 10–15 %;
- CaO: 5–15 %;
- FeO: 5–7 %;
- PbO: 3–5 %;
- Hg: 0.001 %.

The amount of dry cake generated is 200–400 kg/tonne of alloy.

This filter cake is shipped at regular intervals for zinc and lead recycling either to the ISF (Imperial Smelting Furnace) or the Waelz process.

There is a bleed-off from the scrubber system of approximately 0.5–2 m³/tonne of ferro-alloys recovered. This bleed-off is cleaned in several steps as follows:

- cyanide removal;
- reduction of Cr₆₊ to Cr₃₊;
- precipitation of metal hydroxides at a high pH together with the oxidation of cyanides;
- precipitation of fluoride and cleaning the water of particles in a sand filter.

The emissions to water from the recovery of ferro-alloys from steel mill residues using the plasma dust process with a wet scrubber followed by a wet ESP as the abatement technique are presented in Table 8.23.

Table 8.23: Emissions to water from the recovery of ferro-alloys from steel mill residues using the plasma dust process with a wet scrubber followed by a wet ESP as the abatement technique

Component	mg/l	kg/year
As	NA	0.05
Cr	0.3	0.56
Ni	0.1	0.66
Zn	0.5	2.7
Cu	0.2	0.55
Cd	NA	0.04
Pb	NA	0.04
Hg	NA	0.003
F	35	235
Total N	NA	347
CN	0.5	1.05
NB: 2008 total water discharge: 0.2 m ³ /t. 2008 total water treated: 11 761 m ³ . NA = Not available. Source: [379, Sweden 2013]		

Data reported for an example of a waste water treatment plant for a molybdenite roaster and ferro-molybdenum plant are presented in Table 8.24.

Table 8.24: Emissions to water from roasting molybdenite and ferro-molybdenum in one plant

SO ₄ ²⁻ (mg/l)	HF (mg/l)	Mo (mg/l)	Pb (mg/l)	Cu (mg/l)	Zn (mg/l)	As (mg/l)	Se (mg/l)
10–680	1.1–1.3	0.015–1.7	0.008	0.016–0.028	0.035–0.088	0.017	0.018
Source: [407, Euroalliances 2013]							

8.2.5 Process residues

The production of ferro-alloys is related to the generation of a number of by-products, residues and wastes, which are also listed in the European Waste Catalogue. The most important process-specific residues are filter dusts, sludge from wet scrubbers, slag from the reduction process, used furnace linings and packaging material like drums or big bags. These residues are sold as by-products, recycled to the process or, in cases of wastes without economic utility, transported to a deposit or a disposal site. The amount of slag and filter dust or sludge generated per tonne of ferro-alloy produced and the possibilities for exploiting them are shown in Table 8.25 and Table 8.26.

Table 8.25: Generation, recycling, reuse and discharge of ferro-alloy slag

Ferro-alloy		Slag (t/t of alloy)	Analytical composition	Recycling, reuse and discharge
FeCr	HC FeCr	1.0–1.7	Mixture of spinel, MgO, Al ₂ O ₃ , forsterite, 2MgO, SiO ₂ and Cr ₂ O ₃ (3–15 %) Slag is chemically very stable	The low basicity of slag (0.7–1.0) ensures the formation of stable silicates, which are non-leachable. Crushed lump and granulated slag is used as building material and road construction materials. Slag can also be used as a sandblasting grit, and for the production of refractory castables
	MC FeCr	NA	NA	
	LC FeCr	1	CaO 44–45 % SiO ₂ 23–33 % MgO 9–13 % Al ₂ O ₃ 5–9 % Cr ₂ O ₃ 2.5–6.5 % FeO 0.6–1.2 %	The slag will be reused
Alloy recovery from steel mill residues		0.4–1.2	CaO 25–40 % SiO ₂ 35–50 % MgO 3–15 % Al ₂ O ₃ 1–35 % Cr ₂ O ₃ < 3 % Fe ₂ O ₃ < 2 % NiO < 0.1 %	The low basicity of slag (0.7–1.0) ensures the formation of stable silicates, which are non-leachable. The slag is used in various construction applications
Si metal FeSi		20–30 kg/t	Si/FeSi 20–30 % SiO ₂ 5–20 % SiC 20–40 % CaO 25–40 % Al ₂ O ₃ 3–35 %	The production of silicon metal and FeSi is almost a slag-free process (small amounts of quartz are transformed into slag, < 1 %). During refining of silicon metal and FeSi, some small amounts of refining slag are produced. FeSi slag can be reused (i.e. SiMn production, road construction)
CaSi		0.4–0.6	SiO ₂ 10–20 % SiC 15–25 % CaO 50–60 % Al ₂ O ₃ 5–10 % CaC ₂ 3–8 %	All the slag is recycled to the furnace
FeMn	HC FeMn	Electric arc furnace 0.8–1.7	MnO 20–50 % SiO ₂ 20–40 % Al ₂ O ₃ 5–20 % CaO 4–20 % MgO 2–15 %	Standard exhausted slag (low MnO content) is used as a construction material. Rich slag (high MnO content) is sold as raw material for the production of silico-manganese or other metallurgical applications
	MC FeMn	0.9–1.9	Decarburisation process: same as HC FeMn. Silicothermic process: NA	
	LC FeMn	0.9–1.9	Decarburisation process: same as HC FeMn. Silicothermic process: NA	
SiMn		0.9–2.2	MnO 2–17 % SiO ₂ 30–50 % CaO 15–30 % Al ₂ O ₃ 9–30 % MgO 3–15 % K ₂ O 0–2 % BaO 0–2 % S 0–1.5 % Fe < 1 %	Slag is used as a construction material

Ferro-alloy	Slag (t/t of alloy)	Analytical composition	Recycling, reuse and discharge
FeNi	20 (~ 20 % Ni)	MnO 0.3–0.4 % SiO ₂ 35–45 % CaO 3–6 % Al ₂ O ₃ 6–10 % MgO 3–8 % FeO ~ 1–3 % Cr ₂ O ₃ 2–4 % Fe ₂ O ₃ 33–35 %	Slag is sold as secondary raw material to the process industry, e.g. for the production of refractories and geopolymers, as sandblast material, as an additive in the cement industry
FeV	2.6–3	NA	Depending on the composition, the slag is sold for further processing or deposited in a landfill
FeMo	1.5–3	NA	Slag can be used as a construction material
FeW, FeTi, FeB	NA	NA	
FeNb	1.9	NA	
<i>Source: [226, Nordic Report 2008], [406, Greece 2013], [407, Euroalliages 2013]</i>			

Table 8.26: Generation, recycling, reuse and discharge of dust and sludge from the air emissions abatement system

Ferro-alloy		Dust or sludge (kg/t of alloy)	Recycling, reuse and discharge
FeCr	HC FeCr	20–80 ⁽¹⁾	Dust from the furnace will be landfilled. Dust from crushing and screening is remelted in the furnace or is used in stainless steel production. Dust from the raw material transport systems, coke drying, agglomeration and dosing station can be recycled back to the processes. Sludge from the wet scrubber may contain PAH and metals and will in that case need to be discharged to a hazardous waste landfill. About 8–10 kg/t of coarser dust with a high chromium content that is collected in a waste heat boiler after a semi-closed furnace can easily be recirculated to the furnace after agglomeration. Dry dust from FeCr open furnaces often contains Cr(VI) and cannot be landfilled
	MC FeCr	NA	
	LC FeCr	70	Dust is recycled back to the smelting furnace
Alloy recovery from steel mill residues		100–500	Furnace dust is high in ZnO (20–60 %) and PbO (2–6 %). It is pelletised and recycled by the zinc industry (in the IFS or using the Waelz process as an intermediate concentration step). Sludge from the wet scrubber is recycled in the Waelz process to recover Zn and Pb
FeSi		200–300	Silica fume (micro-silica) is collected in the fabric filter and sold as a by-product. Micro-silica is used as a cement additive, which increases the strength of the concrete and leads to a very smooth surface that protects the concrete from water infiltration
Si metal		300–400	
FeMn	HC FeMn	30–50	Dust and sludge are recycled, used in other industries or discharged to a landfill. Sludge from the wet scrubber will contain PAH and metals and need to be treated in a waste water system or discharged in a hazardous waste landfill
	MC FeMn	30–50	Dust and sludge are recycled, used in other industries or discharged to a landfill
	LC FeMn	EAF 30–50	Dust and sludge are recycled, used in other industries or discharged to a landfill
SiMn		30–60	Dust and sludge are recycled, used in other industries or discharged to a landfill. Sludge from wet scrubbers will contain PAH and metals and should be disposed of in a hazardous waste landfill
FeNi		NA	Dust and sludge are pelletised and recycled in the production process (rotary kilns)
FeV		NA	Dust is recycled to the smelting process or partly discharged to a landfill
Molybdenite roasting		NA	Off-gas leaving the roaster contains a quantity of dust equivalent to up to 15 % of the concentrate feed. Most of the dust and sludge from the off-gas cleaning is recycled to the concentrate feed
FeMo		NA	Dust is recycled to the smelting process or sent to special waste disposal or processed to recover Mo
FeW, FeTi, FeB, FeNb		NA	Dust from the furnace is discharged to a landfill except for some FeNb
⁽¹⁾ The composition of the dust or sludge varies depending on the smelting furnace and the raw materials used. Source: [226, Nordic Report 2008], [406, Greece 2013]			

8.2.6 Energy recovery

The production of ferro-alloys is a highly energy-consuming process because high temperatures are needed for the reduction of metal oxides and smelting. Factors affecting the energy consumption are, among other things, the quality of raw materials (such as ores, quartz and reducing agents) and their pretreatment before smelting, the utilisation of reaction energies, and the heat content of the processes. The energy used in the process can be supplied as electrical energy or fossil fuel in the form of coal, coke, charcoal or sometimes natural gas.

The electrical energy used is necessary for the chemical reduction process in the furnace. In a semi-closed furnace, the heat in the off-gases can be recovered in a waste heat boiler. In a closed furnace, the off-gases contain CO, CH₄ and H₂, which can be used for energy production.

In a sealed furnace, if carbon is used as a reducing agent, the process gases produced in the smelting process contain significant concentrations of CO which can be used as a secondary fuel and transferred by pipe within the plant like any other fuel gas. It can be used by direct burning for instance in the sinter furnace and for drying or preheating the furnace charge, as well as for energy recovery in the form of hot water, steam and/or electricity.

Recovery of energy from ferro-alloy smelting furnaces is site-specific as it relies on the technical and economic feasibility. There are several examples of successful energy recovery.

Figure 8.20 below shows the energy flow in a 10 MW_e submerged electric arc furnace for the production of silicon metal.

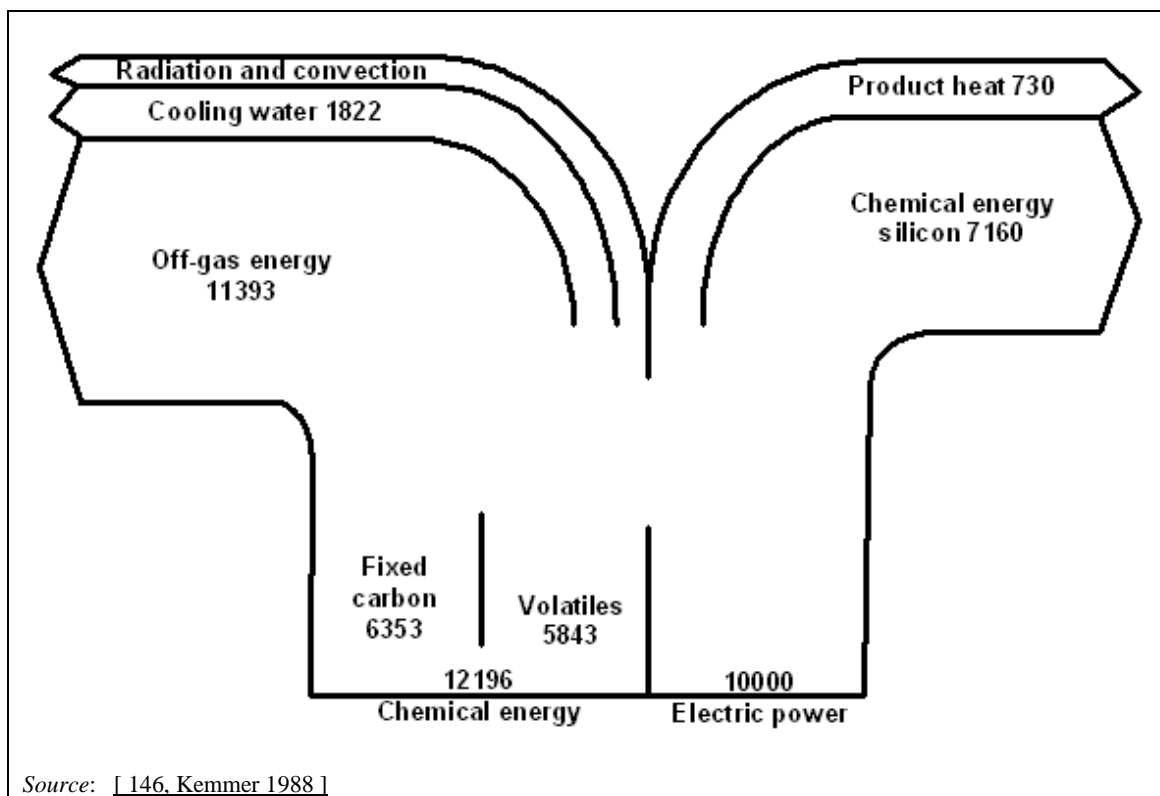

Figure 8.20: Energy flowsheet (in MW_{th}) in a 10 MW_e silicon furnace

Figure 8.20 shows that there is a large amount of waste energy from the silicon and ferro-silicon processes. For instance, in the production of ferro-silicon and silicon metal, only about 32 % of the energy consumed is retained as chemical energy in the product. This means that about 68 % of the energy is lost as waste heat in the furnace off-gas and cooling water system. The figure

also shows that volatiles from the reduction materials contribute significantly to the energy input. The viability of energy recovery is a site-specific issue depending on potential savings and the use of the energy.

There are some direct plant improvements that can be made to reduce energy consumption, such as running the process with a high metal yield or improving the furnace design to achieve lower energy loss. A high amount of metal oxides would imply a lower content of gangue materials and less slag generation, thus reducing the proportion of electrical power necessary to melt the slag. Nevertheless, the quality of raw materials and their metal oxide content are limited by the necessary minimum proportion of slag to metal required to achieve the adequate operating conditions of the furnace in the production of ferro-alloys.

In the case of silico-manganese production, the introduction of metallic silicon can decrease the energy consumed [243, France 2008].

In a plant in Austria producing ferro-vanadium, the electricity consumption of the electric arc furnace is reduced by higher reaction enthalpy during the reaction of V_2O_5 and aluminium if a higher quantity of V_2O_5 is available. In return, the higher oxygen content of the raw material must be reduced by including a higher quantity of aluminium. The specific electricity consumption has been gradually reduced from an yearly average of 3.1 kWh/kg of vanadium to < 1.0 kWh/kg of vanadium. This energy reduction has been mainly achieved by improving the operating mode.

In addition to the direct plant improvements, about 15–20 % of the electrical energy consumed by the electric arc furnace can be recovered as electricity by an energy recovery system. This percentage is considerably higher for a system that produces electricity and uses the thermal energy of the furnace cooling and the off-gas. This will also be the case if the CO gas is utilised directly as a secondary fuel in order to replace fossil fuels.

The best way to recover energy is to produce heat energy. The temperature from the furnace is determined by the total off-gas from the furnace and may vary from 200 °C to 900 °C. Due to the lack of a (economically) feasible usage for heat energy, some installations recover energy as electrical energy. This gives a lower energy recovery rate.

Often energy recovery efficiency is defined as the amount of energy recovered in relation to the electrical energy input to the furnace, as shown in Table 8.27.

Table 8.27: Energy recovery efficiency for silicon and ferro-silicon furnaces

Applicability	Electric power recovery (%) ⁽¹⁾	Heat energy recovery (%) ⁽¹⁾ (hot water or steam)
Existing plants	22	70
Optimised new plants	30–35	70–100

⁽¹⁾ Recovery is related to the electrical energy input to the reduction furnace. The heat energy in the off-gas may be in the order of 20 % higher than the electrical energy.
Source: [226, Nordic Report 2008]

If a semi-closed submerged electric arc furnace is used for the production of FeCr, FeSi, silicon metal, SiMn or FeMn, the CO gas from the smelting process burns in air, thus creating a hot off-gas. Therefore, the semi-closed furnaces are sometimes equipped with a waste heat boiler as an integrated energy recovery system. The waste heat boiler generates superheated steam that can be sold to neighbouring mills or used for electricity production in a back-pressure turbine.

During the production of FeCr, FeMn or SiMn in a closed electric arc furnace, the off-gas contains a very high percentage of CO, which is collected without being burnt above the charge surface. This CO is a high-quality fuel that can be favourably used for electricity production or

supplied to a neighbouring industrial plant as a secondary fuel or as a synthesis gas that serves as a raw material in chemical processes. A typical CO-rich gas formed in a closed furnace producing HC FeCr contains 75–90 % CO, 2–15 % H₂, 2–10 % CO₂, 2–5 % N₂ and < 5 % H₂O.

Table 8.28 and Table 8.29 give an overview of the different possibilities for energy recovery and the use of the recovered energy.

Table 8.28: Overview of energy recovery in the Norwegian ferro-alloys industry

Ferro-alloy	Number of plants	Electrical energy used (GWh/yr)	Possible recovery (GWh/yr)			Actual recovery (GWh/yr)		
			Electrical energy	Thermal energy	Total	Electrical energy	Thermal energy	Total
FeSi	9	4940	856	1024	1880	115	183	298
Si metal	3	1250	163	215	378		1	1
FeMn SiMn	4 ⁽¹⁾	2290	100	790	890	90	386	476
Total	16	8480	1119	2029	3148	205	570	595 ⁽²⁾

⁽¹⁾ Gas is partly used as fuel or synthetic gas.
⁽²⁾ Of the 16 reported ferro-alloy plants in 1989, energy was recovered by 8 plants.
 NB: Energy recovery data of 16 Norwegian ferro-alloy plants.
 Source [148, Kolbeinsen, L. et al. 1995], [226, Nordic Report 2008]

Table 8.29: Energy reuse when producing bulk ferro-alloys

Ferro-alloy	HC FeCr		HC FeMn		SiMn		FeSi	Si metal
	Semi-closed EAF	Closed EAF	Semi-closed EAF	Closed EAF	Semi-closed EAF	Closed EAF	Semi-closed EAF	Semi-closed EAF
Drying		X	X	X	X	X		
Ladle heating		X		X		X		
Sintering		X		X		X		
Preheating		X		X		X		
Hot water	X	X	X	X	X	X	X	X
Steam	X	X	X	X	X	X	X	X
Electricity	X	X	X	X	X	X	X	X
Neighbouring mills	X	X				X	X	X

NB: Energy recovery is not always used because local conditions, for instance local energy prices, production periods and the absence of possible customers, should be taken into account.
 Source [148, Kolbeinsen, L. et al. 1995]

8.3 Techniques to consider in the determination of BAT

The sections of this document entitled 'Techniques to consider in the determination of BAT' set out techniques generally considered to have the potential for achieving a high level of environmental protection in the industries within the scope of the document. The background to the way the techniques are described is given in Section 2.12 and Table 2.10.

This section presents a number of techniques for the prevention or reduction of emissions and residues as well as techniques for reducing the overall energy consumption. They are all commercially available. Examples are given in order to demonstrate techniques which illustrate a good environmental performance. The techniques that are given as examples are based on information provided by the industry, European Member States and the evaluation of the European IPPC Bureau. The general techniques described in Chapter 2 on common processes apply to a great extent to the processes in this sector and influence the manner in which the main and associated processes are controlled and operated.

8.3.1 Raw materials, reception, handling and storage

8.3.1.1 Techniques to reduce emissions from the reception, storage and handling of primary materials

General techniques applied to reduce diffuse emissions from the storage, handling and transport of raw materials for ferro-alloys production are considered in Chapter 2 (see Section 2.12.4.1) and in the Emissions from Storage BREF [290, COM 2006]

Description

The technique to consider is the use of a bag filter (see Section 2.12.5.1.4).

Technical description

The raw materials used for the production of ferro-alloys are basically ores, quartz, concentrates, reducing agents (coke, coal, woodchips or other carbon-rich compounds), electrodes or another energy source, such as plasma, fuels (gaseous, solid or liquid) and additives. The main environmental impacts of the storage and handling of these materials are diffuse dust emissions and the contamination of surface water and soil caused by washout from rainwater.

Dusty fine materials are handled on conveyors. Depending on their hazard classification and on their potential impact, water sprays can be used at transfer points to abate the dust, or closed conveyors and transfer systems can be used where extraction and filtration equipment are used for dusty delivery points. In these cases, the dust-laden air from the silos, closed conveyors, and charging systems is cleaned using bag filters, which may be monitored by measuring the pressure drop to control the cleaning mechanism.

Achieved environmental benefits

Reduction of dust emissions.

Environmental performance and operational data

Table 8.30 shows the dust emissions from the reception, handling and storage of primary materials.

Table 8.30: Dust emissions from the reception, handling and storage of primary materials

Plant	Ferro-alloy produced	Pollutant	Abatement technique	Minimum (mg/Nm ³)	Average (mg/Nm ³)	Maximum (mg/Nm ³)	Type of measurement	Monitoring frequency (number/year)	
Y	SiMn	Dust	Bag filter	3.6	15.6	Invalid data (higher than ELV)	Periodic	12	
X	FeMo			0.4	17.7	NR	Periodic	2	
AC	FeV + FeMo			NA	2.00	NA	NA	Periodic (4 furnaces)	NA
					1.13				
					1.01				
O	FeMn			3	4.6	5.6	Periodic	Once every 5 years (3 samples)	
O	SiMn	0.4	0.65	0.8	Periodic	Once every 5 years (3 samples)			

NB: NA = Not available. NR = Not representative.
Source: [378, Industrial NGOs 2012]

Cross-media effects

No information provided.

Technical considerations relevant to applicability

This technique is applicable to most installations.

Economics

No information provided.

Driving force for implementation

- Environmental impact.
- Indirect energy loss.

Example plants

Plants in NO, AT, BE and ES.

Reference literature

[290, COM 2006],

8.3.2 Material pretreatment techniques**8.3.2.1 Techniques to reduce emissions from the crushing and grinding of raw materials****Description**

The technique to consider is the use of a bag filter (see Section 2.12.5.1.4).

Technical description

Some plants use crushers and screens to obtain the desired size of the charging material. If the material is wet, the problem with diffuse dust from the crushers is small as the dust is heavy.

Crushing and screening of wet materials can be performed outdoors if dust is not produced. The crushing facilities are built in a manner that minimises noise emissions and vibration. If needed, bag filters clean the suction air of crushers and agglomeration equipment. The collected dust is recycled to the charging system, and may need an additional agglomeration step (not necessary if the operation is performed indoors).

When mobile equipment is used for the crushing of dry and dusty raw materials or crushing of wet slags that are used as raw materials, dust emissions should be controlled by the use of a water spraying system. In these cases, the water is recycled.

High-grade ores, especially for the production of ferro-chrome, are not always readily available as lump material. Upgrading low-grade ores by wet grinding or wet gravitational methods (heavy media separation, jig washing, spiral washing, wash tables, etc.), to remove gangue minerals and increase, for instance, the Cr_2O_3 content, is common practice worldwide. Most of these methods give a fine-grained, high-grade product that must be dewatered by filtering, and agglomerated by briquetting, sintering or pelletising/sintering before smelting. Also, lump material such as quartz may be washed using water to remove fine material which contains a higher amount of impurities.

Achieved environmental benefits

Reduction of emissions to air.

Environmental performance and operational data

In Table 8.31 the dust emissions from crushing and grinding of raw materials are reported.

Table 8.31: Dust emissions from crushing and grinding of raw materials

Plant	Ferro-alloy produced	Pollutant	Abatement technique	Minimum (mg/Nm ³)	Average (mg/Nm ³)	Maximum (mg/Nm ³)	Type of measurement	Monitoring frequency (number/year)
S	Si	Dust	Bag filter	NA	0.53	NA	Periodic	1 (12 samples, 2 hours each)
I	LC SiMn + HC SiMn			7.8	8.3	8.8	Periodic	4
T	Si			1.6	1.6	1.7	Periodic	1 (3 samples)
DE 1	FeCr			0.2	NA	0.3	Periodic	Half-hourly

NB: NA = Not available.
 Source: [378, Industrial NGOs 2012]

Cross-media effects

No information provided.

Technical considerations relevant to applicability

Generally applicable.

Economics

No information provided.

Driving force for implementation

Reduction of dust emissions.

Example plants

Plants in NO, FR and ES.

Reference literature

No reference literature provided.

8.3.2.2 Techniques to reduce emissions from metering, mixing and blending**Description**

The techniques to consider are:

- water sprays;
- bag filter (see Section 2.12.5.1.4).

Technical description

Before sintering, the mixing is done by layering primary materials on conveyor belts. The mixing can also be improved by using closed mixing drums. Closed conveyors and transfer systems are used for the handling of dusty fine materials. Extraction and filtration equipment are used for dusty delivery points. The dust-laden air from closed conveyors and charging systems is cleaned using bag filters, which may be monitored by measuring the pressure drop to control the cleaning mechanism.

Water spraying or misting systems can be used at the transfer points of conveyor systems when handling dusty materials. For instance, nozzles spraying a small amount of water can be located above the conveyors transferring the materials contained in the raw materials silos into the weigh hoppers in the metering/blending systems. The fine water droplets capture the dust particles in the air and agglomerate them into heavier and larger ones that fall quickly onto the conveyor or to the ground. For an efficient operation, the size of the water droplets needs to be as small as possible, and good housekeeping is needed.

Achieved environmental benefits

Reduction of dust and metal emissions.

Environmental performance and operational data

Table 8.32 shows the dust emissions from metering, mixing and blending.

Table 8.32: Dust emissions from metering, mixing and blending

Plant	Ferro-alloy produced	Pollutant	Abatement technique	Minimum (mg/Nm ³)	Average (mg/Nm ³)	Maximum (mg/Nm ³)	Type of measurement
Y	SiMn	Dust	Bag filter	3.0	4.8	7.7	Continuous
AC	FeV + FeMo	Dust	Bag filter	NA	1.01 1.74	NA	Periodic

NB: NA = Not available.
 Source: [378, Industrial NGOs 2012]

Cross-media effects

No information provided.

Technical considerations relevant to applicability

Generally applicable.

Economics

No information provided.

Driving force for implementation

No information provided.

Example plants

Plants in Norway and Austria.

Reference literature

[369, Treibacher Industries AG 2008]

8.3.2.3 Techniques to prevent and reduce emissions from the briquetting, pelletising, sintering of raw materials

Description

The techniques to consider are:

- ESP (see Section 2.12.5.1.1) and bag filter (see Section 2.12.5.1.4) with or without injection of specific clays;
- wet scrubber (see Section 2.12.5.1.6).

Technical description

A large number of ores and concentrates are only available as fines and, to use these fines, some plants, especially those producing HC FeCr, HC FeMn and SiMn, use sintered pellets as a raw material in the furnace. The most important reason for sintering fines is to obtain a better porosity of the burden, with an easier penetration and elimination of gas generated by the reduction reactions. Sintering can take place in grate furnaces (manganese sinter for the production of HC FeMn or SiMn) or in steel belt sintering furnaces (sinter chromite pellets for the production of FeCr), with the latter providing several economic and environmental advantages.

Dust is the main issue with cold processes, while other emissions (SO₂, etc.) should concern only hot briquetting and sintering.

The off-gases generated during grate sintering can be dedusted with an electrostatic precipitator and fabric filters. A complementary filtration of the off-gas produced during the sintering and cooling of the sinter can be achieved using cyclones or fabric filters.

It should be noted that some ores, for example manganese ores, have an increased mercury concentration. The volatile mercury is released in the processes and methods are needed to reduce mercury emissions. Mercury, as well as other pollutants like SO_x or dioxins, can be chemically captured inside the filter by injecting specific clays directly into the off-gas.

The only EU-28 plant applying a steel belt sintering furnace uses wet scrubbers as abatement equipment. Worldwide there are about 15 plants using steel belt sintering furnaces.

Achieved environmental benefits

Reduction of dust and metal emissions.

Environmental performance and operational data

ESP and bag filter with or without injection of specific clays

Table 8.33: Emissions from briquetting, pelletising and sintering

Plant	Ferro-alloy produced	Pollutant	Abatement technique	Minimum (mg/Nm ³)	Average (mg/Nm ³)	Maximum (mg/Nm ³)	Type of measurement	Monitoring frequency (number/year)
Z	HC FeMn	Dust	ESP + chemically activated bag filter	2.1	2.8	3.9	Continuous	Half-hourly
		Hg		0.00	0.02	0.08	Periodic	39
		Pb		0.01	0.04	0.11		
		As		0.00	0.003	0.017		
		Cd		0.00	0.003	0.014		
		Zn		0.02	1.29	1.80	Periodic	36
		Mn		0.02	0.51	1.35	Periodic	12
		SO ₂		19	87	129	Periodic	21
		NO _x		158	261	333	Periodic	15
		PCDD/F		0.01 ng/Nm ³	0.07 ng/Nm ³	0.16 ng/Nm ³	Periodic	
Y	SiMn	Dust	NR	0.04	1.3	4.5	Continuous	
DE 1	FeCr	Dust	Bag filter	1.8	NR	2.8	Periodic	Half-hourly

NB: NR = Not reported.
Source: [378, Industrial NGOs 2012] [385, Germany 2012]

Wet scrubber

Emissions below 10 mg/Nm³ as daily average values have been reported for wet scrubbers at this stage.

Technical considerations relevant to applicability

Different types of wet scrubbers are used in certain processes due to both the cold climate and winter conditions (i.e. where temperatures might be between -10 °C and -45 °C for extended periods) and the moisture of the gases coming from these processes. In these conditions, bag filters are not applicable due to the moisture content and low temperature of the process gases, which cause freezing and clogging of the filter.

Economics

Investment costs for a bag filter (< 100 000 m³/h) are about EUR 3 million.

Driving force for implementation

- Reduction of emissions.
- Reduction in energy consumption.

Example plants

- Bag filter: Plants in France and Norway (grate sintering).
- Wet scrubber: Plant in Finland (steel belt sintering).

Reference literature

No reference literature provided.

8.3.2.4 Techniques to reduce emissions from the drying of ores and other raw materials

Techniques to reduce emissions from the drying of sulphidic ores are relevant in the production of ferro-nickel. They are already described in the chapter on nickel production.

A plant outside Europe, processing lateritic ores, is using an ESP as a stand-alone technique to abate dust from an ore dryer. The ESP was commissioned recently and values for just one month were reported. Dust emission values range from 24 mg/Nm³ to 58 mg/Nm³, with an average value of 36 mg/Nm³.

When the raw materials used for the production of ferro-alloys come from a steel mill, the residues in submerged electric arc furnaces are predominantly dry EAF dust. They are generally blended and require drying only if the moisture in the mix exceeds the range required for cold briquetting. Cold briquetting requires moisture in any case. By contrast, for the plasma process, drying is necessary.

8.3.2.5 Techniques to reduce emissions from coke drying

Description

The technique to consider is the use of a bag filter (see Section 2.12.5.1.4).

Technical description

A shaft furnace is used for coke drying in one ferro-chrome production plant. The furnace uses CO-rich off-gas from the smelting furnace as a fuel. For the abatement equipment, a bag filter or a wet scrubber can be used [138, Niemelä, P. 1999].

The moisture of the coke used in the smelting process can be as high as 10–20 % when the coke is wet-quenched. High moisture contents in the raw materials are generally harmful to the smelting process, particularly in closed furnaces, and also lead to increased power and coke consumption. Coke drying is a way of ensuring the right amount of carbon in a smelting charge.

Achieved environmental benefits

- Reduced generation of dust and fines.
- The use of CO-rich off-gas as a fuel reduces the overall energy consumption of the process. The energy content of the CO used for drying is 550–700 MJ.

Environmental performance and operational data

Coke dust emissions to air are around 35–45 g/tonne of coke. The temperatures of the coke bed are low for the formation of SO₂. Emissions of CO₂ are 45–70 kg/tonne of FeCr, and of NO₂ about 20 g/tonne of coke.

Cross-media effects

No information provided.

Technical considerations relevant to applicability

The use of a bag filter is generally applicable.

The technique is applicable to all new and existing plants that use wet-quenched coke, provided there is a CO-rich off-gas available from the furnaces.

Economics

No information provided.

Driving force for implementation

- Reduction of energy consumption.
- Reduction of emissions.

Example plants

A plant in Finland.

Reference literature

[138, Niemelä, P. 1999].

8.3.2.6 Techniques to reduce emissions from the thermal treatment of rolling scale or swarf before smelting**Description**

The technique to consider is the use of an afterburner (see Section 2.12.5.2.1) followed by a ceramic filter (see Section 2.12.5.1.5).

Technical description

The degreasing of titanium swarf in a rotary kiln is described in Section 8.1.8 on ferro-titanium production.

The maximum temperature of gases entering the filter plant is 350 °C. The filter is rated at approximately 7000 Nm³/h at 350 °C and contains 576 ceramic filters. The filters are tubular and manufactured from calcium or alumina silicate. The cleaning cycle is fully automated and cleaning is achieved by means of a reverse air pulse system. Dust emissions from the stack are continuously monitored and any deviation above a preset level signals an alarm.

Although for most applications the metals industry uses bag filters to control airborne emissions, for this application, a ceramic filter is used due to the high temperature of the waste gas stream. The ceramic filter provides good filtration with the lowest environmental impact.

Achieved environmental benefits

Reduction of dust and VOC emissions.

Environmental performance and operational data

The plant uses the following utilities:

- Gas: the amount of gas consumed varies widely depending on the density of the material being processed and the amount of oil and moisture contamination present. The average consumption is typically 374 m³/tonne of swarf processed.
- Electricity: the plant is not independently metered. However, it is calculated that electricity consumption is typically 180 kWh/tonne of swarf processed.
- Water: none is used.

The afterburner achieves VOC values below 20 mg/Nm³ and ceramic filters dust values below 5 mg/Nm³.

No emissions to water occur and waste fume dusts from the process are taken to a licensed landfill site. The quantity of fume dust generated will depend on the quantity and quality of the swarf being processed.

Cross-media effects

No information provided.

Technical considerations relevant to applicability

These techniques are applicable to new and existing plants.

Economics

The rotary dryer and afterburner were installed in 1993. The cost in 1998 was EUR 0.607 million. The cyclone, ducting and (ceramic filter) filtration plant installed in 1998 cost EUR 0.410 million. The estimated overall project cost (1998) was EUR 1.017 million

Driving for implementation

Reduction of emissions.

Example plants

A plant in the UK.

Reference literature

[159, Coulton, G. 1999]

8.3.2.7 Preheating and pre-reduction of ores to reduce the energy consumption

Description

The preheating and pre-reduction of chromite, laterite or manganese ore using furnace gas reduces the specific electrical energy consumption and increases the productivity of the smelting furnace at the same time.

Technical description

For manganese ore, the pre-reduction of higher manganese oxides is achieved directly in the upper part of the furnace itself when lumpy ore is used or during the sintering in the sinter plant. Other pre-reduction techniques (rotary kiln, shaft-type kiln, etc.) could be used for manganese but are currently only used by a very small number of plants (if any) worldwide.

When mercury is present in the raw materials used (e.g. some manganese ores), the volatile mercury is released in the process and hence it is necessary to take action to reduce mercury emissions.

In Japan, in ferro-chrome production, chromite ore fines are pelletised with coke as a reducing agent and fired in a rotary kiln. A pulverised coal/CO/oil burner heats the kiln. Waste heat from the kiln is recovered in a waste heat boiler to generate steam. The exhaust gas is cleaned in a bag filter. The pre-reduced pellets are stored in a completely sealed surge hopper designed to prevent reoxidation. The reduced material is then charged hot to the furnace, which combines preheating and pre-reduction

In ferro-nickel production, the preheating and pre-reduction of the metallurgical mixture (laterite ores, recycled dust and sludge in the form of pellets, coal and coke) is applied in the rotary kiln prior to the smelting furnace. The benefits are the decrease in electrical energy consumption and the increase in the productivity of the smelting furnace.

In the Outokumpu process, the charge is preheated by the CO gas generated by smelting. By preheating the charge, it has been possible to cut the consumption of electric energy by 250–330 MJ per 100 °C increase in preheating temperature per tonne of ferro-chrome. By preheating the charge to 700 °C, the moisture and most of the volatiles can be removed before the material is charged into the electric furnace. Thus the formation of reduction gases in the submerged arc furnace is stable.

The preheating kiln is closed. The pressure is kept at zero over the bed in the shaft-type kiln to avoid leakage of air into the kiln or leakage of gas to the environment. Carbon losses are minimised by the temperature (800 °C) and very low oxygen content inside the kiln. The off-gas from the kiln is cleaned in a Venturi scrubber.

This technique is not only used to reduce the energy consumption, it also makes the raw material supplied to the closed furnace more uniform and facilitates the chemical processes taking place in the furnace.

Achieved environmental benefits

- Reduction of the electrical energy required for the subsequent smelting process. For the processes producing HC FeCr or HC FeMn in closed furnaces, coke consumption is in the range of 420–520 kg/tonne. Pre-reduction of the ore using coal or other carbonaceous materials as an energy source and as a reducing agent will lower both the amount of coke and the electric power required in the reduction furnace.
- By preheating the charge to 700 °C, the moisture and most of the volatiles can be removed before the material is charged into the electric furnace. Thus the formation of reduction gases in the furnace is stable.

Environmental performance and operational data

The electrical energy consumption of the subsequent smelting furnace is reduced by 70–90 kWh per 100 °C increase in the preheating temperature of the smelting furnace.

In the shaft-type kiln, where pellets/lumpy ore mix and a preheating temperature of 700 °C are used, the amount of off-gas released to air is 500–600 Nm³/tonne of FeCr, the CO₂ amount is 300–400 kg/tonne of FeCr and the dust emission is 1–5 g/tonne of FeCr. The kiln processes are equipped with extraction and abatement equipment. Because of the temperatures, wet scrubbing is used to clean off-gases. The inert sludge can be used for some construction applications.

Cross-media effects

In the rotary kiln pre-reduction technique, there is an increase in the total consumption of carbonaceous materials and the gross energy consumption of the process as a whole [149, Schei, A, et al. 1998].

In shaft preheating, the consumption does not increase.

Technical considerations relevant to applicability

Preheating and pre-reduction are applicable to new and existing plants.

The use of CO as a secondary fuel is only possible for plants using closed furnaces.

Economics

No information provided.

Driving force for implementation

Reduction of energy consumption (the electricity consumption of ferro-chrome smelting can be decreased by preheating the feed materials).

Example plants

Plants in France and Finland.

Reference literature

[111, Shunan Denko, Japan 1998], [140, Ferro-Alloy Expert Group 1998], [243, France 2008]

8.3.3 Ferro-alloy reduction

8.3.3.1 Techniques to prevent and reduce emissions from smelters

In the production of ferro-alloys, the most important stage is the reduction of metal oxides and the alloying with the iron present in the process. Depending on the reducing agent, different types of smelting systems (such as the electric arc furnace or a reaction crucible) are used. Electric arc furnaces are normally operated submerged as a closed, semi-closed or open type. The designs of the different smelting systems are influenced by the desired production flexibility, the range of raw materials, the possibilities for energy recovery in new furnaces, the furnace design, and the environmental performance. The different techniques to be considered for the recovery of energy depend on the smelting system used and on local conditions such as energy prices, periods of construction and the presence of potential customers.

The different furnaces used for the production of ferro-alloys have been described earlier and are listed in Table 8.4, which summarises the alloys produced and the advantages/disadvantages of the various systems.

8.3.3.1.1 Techniques to prevent and reduce emissions from open submerged arc furnaces

Open furnaces have a higher electrical energy consumption than semi-closed or closed furnaces, due to the higher off-gas volume to be cleaned and to the different operation modes (e.g. use of fines, furnace conditions, lack of preheating). Also, energy recovery is much more restricted (only as hot water) than in the case of semi-closed and closed furnaces.

Open submerged arc furnaces with three electrodes are used for the production of FeMn, SiMn, FeSi, FeNi and silicon metal and for alloy recovery. Open submerged furnaces with one electrode are used for FeV, FeB and special ferro-alloys production. The open furnace is also used in the smelting of ferro-alloys from steel mill residues. In a ferro-alloy plant in Austria, FeV₈₀ is produced in an open submerged arc furnace with three electrodes.

Description

The technique to consider is the use of a bag filter (see Section 2.12.5.1.4) with or without injection of adsorbents.

Technical description

Bag filter

Bag filters, in many cases in the ferro-alloy and metallurgical industry, are pressure filters with fans on the dirty fume/gas side. Closed suction filters with fans on the clean gas side are also used. Closed suction filters, compared with overpressure filters, have advantages when it comes to energy recovery (for electricity production) and in certain monitoring conditions.

Bag filter with adsorbent injection

When mercury is present in the raw materials used (e.g. some manganese ores), the volatile mercury is released in the processes and specific techniques are needed to reduce mercury emissions. For smelting ferro-alloys from steel mill residues, the high zinc content of the raw materials (up to 30 % ZnO) requires excess air in order to ensure the combustion of zinc vapour present in the off-gas and the collection of large amounts of ZnO-rich dust (up to 200 kg per tonne of raw materials) in bag filters.

In these furnaces, the injection of activated carbon or lignite coke is used to lower dioxin and mercury levels in the off-gas.

Achieved environmental benefits

Bag filter

Reduction of dust and metal emissions.

Bag filter with adsorbent injection

Reduction of dust, mercury, cadmium and dioxins emissions.

Environmental performance and operational data

Bag filter

Table 8.34: Emissions from open submerged arc furnaces (concentrations)

Plant	Ferro-alloy produced	Pollutant	Abatement technique	Minimum (mg/Nm ³)	Average (mg/Nm ³)	Maximum (mg/Nm ³)	Type of measurement	Monitoring frequency (number/year)				
T	FeSi	Dust	Bag filter	NA	0.53	NA	Periodic (furnace A)	1 (2 samples)				
		SO ₂	None		36			1 (1 sample)				
		NO _x			10							
	FeSi	Dust	Bag filter	NA	NR	NA	Periodic (furnace B)	1 (2 samples)				
		SO ₂	None		50			1 (1 sample)				
		NO _x			27							
	FeSi	Dust	Bag filter	NA	NR	NA	Periodic (furnace C)	1 (2 samples)				
		SO ₂	None		65			1 (1 sample)				
		NO _x			55							
P	Si metal	Dust	Bag filter	0.6	1.6	2.6	Periodic (furnace A, years 2010, 2011 and 2012)	2				
				2.7	5.5	8.2						
				1.5	4.5	7.4						
				2.2	2.2	2.2	Periodic (furnace B, year 2012; in years 2010 and 2011 furnaces A and B shared the bag filter)					
				2.7	5.5	8.2						
				1.5	4.5	7.4	Periodic (furnace C, years 2010, 2011 and 2012)					
				1.9	2.5	3.1						
				2.9	3.9	4.9						
					SO ₂	None	34		86	169	NA	NA
					NO _x	None	29.4		83	131	NA	NA
Q	Si metal	Dust	Bag filter	NA	3.9	NA	Periodic	2				
		SO ₂	None		41							
		NO _x			42							
		VOCs			3.75							
R	Si metal	Dust	Bag filter	NA	5.4	NA	Periodic (furnace A)	3				
		Particulate metals			0.12							
		SO ₂	None		19				1			
		NO _x			18							
		VOCs			3.2							
		PAH			0.00002							
		PCDD/F			0.0008 ng/Nm ³							
	FeSi	Dust	Bag filter	NA	31.17*	NA	Periodic (furnace B)	3				
		Particulate metals	0.08									
		SO ₂	82									
		NO _x	28									
		VOCs	8.57									
		PAH	0.0001									
		PCDD/F	0.0018 ng/Nm ³									
CaSi	Dust	Bag filter	NA	22.0*	NA	Periodic (furnace C)	3					
	Particulate metals			0.05								
	SO ₂	None		48.3				1				
	NO _x			34.3								
	VOCs			8.57								
	PAH			0.00001								
	PCDD/F			0.0008 ng/Nm ³								
S	Si	Dust	NA	0.86	2.84	8.2**	Periodic		1 (12 samples)			

U	metal	Particulate metals		NA	0.048	NA	(furnace A)	1 (1 sample)			
		SO ₂			18						
		NO _x			41						
		VOCs			0.98						
	PAH	NM									
	Si metal	Dust	Bag filter	1.01	14.98**	NA	Periodic (furnaces B and C)	1 (16 samples)			
		Particulate metals	None	NA	0.086	NA		1 (1 sample)			
		SO ₂							9.4		
		NO _x							28		
		VOCs							2.33		
PAH		NM									
Si metal	Dust	Bag filter	1.7	2.0	2.8	Periodic (furnace A)	1 (4 samples)				
	Particulate metals	None	NA	0.008	NA		1 (2 samples)				
	SO ₂						31	32	32	1 (2 samples)	
	NO _x						6.3	6.4	6.3	1	
	VOCs						NA	10	NA	1	
	PAH						0.0002			1 (2 samples)	
	Si metal	Dust	Bag filter	1.4	4.0	11.4* *	Periodic (furnace B)	1 (4 samples)			
		Particulate metals	None	0.008	0.17	0.328		1 (2 samples)			
		SO ₂						30.3	31.2	32	1 (2 samples)
		NO _x						NA	19	NA	1
VOCs		NA						12	NA	1	
PAH		0.0008						0.0008	0.0009	1 (2 samples)	
Si metal	Dust	Bag filter	1.5	1.6	1.7	Periodic (furnace C)	1 (4 samples)				
	Particulate metals	None	0.008	0.008	0.009		1 (2 samples)				
	SO ₂						34.5	35.3	36	1 (2 samples)	
	NO _x						NA	17.8	NA	1	
	VOCs						NA	5.4	NA	1	
	PAH						0.0009	0.0001	0.0001	1 (2 samples)	
V	Si metal	Dust	Bag filter	NA	11.3	NA	Periodic	1			
		Particulate metals			0.007						
		SO ₂	None		210						
		NO _x			34						
		VOCs			8.9						
		PAH			0.045						
H	HC FeMn	Dust	Bag filter	1.53	4.141	7.96	Periodic	5			
		Cd+Hg+Tl		0.0012	0.0087	0.016					
		Pb		0.0041	0.011	0.0302					
		Mn		0.68	1.24	2.368					
		Sb+Cr+Co+Cu+Mn+Ni+V		0.7	1.37	2.41					
		As+Te+Se	0.001	0.002	0.004						
		HCl	None	0.09	1.8	3.7					
		HF		0.19	0.26	0.85					
		SO ₂		0.232	1.6	2.9					
		NO _x		7.14	11.34	15.4					
		VOCs		0.5	1.14	4.4					
		PCDD/F		0.0031 ng/N m ³	0.013 ng/Nm ³	0.024 ng/N m ³					
		AC		FeV + FeMo	Dust	Bag filter			NA	1.0	NA
0.99											
1.07											
1.36											
Organic carbon	None	1.7			3.3						

		PAH		NA	23 µg/Nm ³	NA		
		PCDD/F			< 0.001 ng I- TEQ/Nm ³			
O	LC SiMn	Dust	Bag filter	0	3	NA	Continuous (year 2012)	Daily
		Pb+Cd+Hg		0.004	0.005	0.007	Periodic	3
		CO	None	17	70	213	Continuous	Daily
		SO ₂		0	0	0	Periodic	24
		NO _x		0	7	16		
PCDD/F	0.004 ng I- TEQ/ Nm ³	0.007 ng I-TEQ/ Nm ³	NA	Periodic	1			
O	LC SiMn	Dust	Bag filter	1	2.1	4.2	Periodic (year 2012)	1
DE 1	FeCr	Dust	Bag filter	0.1	NA	0.4	Periodic (year 2011)	Half-hourly

* Reported ELV is 9 mg/Nm³.
** Reported ELV is 5 mg/Nm³.
NB: NA = Not available. NM = Not measured. NR = Not representative.
Source: [378, Industrial NGOs 2012]

Table 8.35: Emissions from open submerged arc furnaces (mass loads)

Plant	Ferro-alloy produced	Pollutant	Abatement technique	Minimum (kg/t)	Average (kg/t)	Maximum (kg/t)	Type of measurement	Monitoring frequency (number/year)
N	FeSi	Dust	Bag filter	0.56	0.57	0.58	Calculated	
		SO ₂	Primary measures	4.0	6.3	8.7	Periodic	2 times (1 sample each time)
		NO _x		4.7	5.4	6.1		2 times (3 samples each time)
M	FeSi	Dust	Bag filter	0.47	0.47	0.47	Calculated	
		SO ₂	Primary measures	4.5	5.4	6.3	Periodic	2 times (1 sample each time)
		NO _x		2.2	3.6	3.9		2 times (3 samples each time)

Source: [378, Industrial NGOs 2012]

Bag filter with adsorbent injection

Emissions of mercury and cadmium of below 0.2 mg/Nm³ can be achieved.

Cross-media effects

Increase in energy consumption.

Technical considerations relevant to applicability*Bag filter*

Bag filters can be applied both in open submerged arc furnaces with three electrodes and in those with a single electrode.

Technical restrictions can influence the type of measurements: for ferro-silicon and silicon metal, the higher temperature of the fume and the specific geometry of the exhaust of the bag filter (exhaust boxes instead of exhaust pipe) do not technically permit continuous monitoring.

Bag filter with adsorbent injection

The injection of adsorbent is associated with processes like alloy recovery from steel mill residues, where there is a need to reduce the volatile metals (e.g. mercury) content in the off-gas.

Economics

No information provided.

Driving force for implementation

Reduction of dust emissions.

Example plants

Plants in ES, FR and AT.

Reference literature

[369, Treibacher Industries AG 2008]

8.3.3.1.2 Techniques to prevent and reduce emissions from semi-closed submerged arc furnaces

Semi-closed submerged arc furnaces are used to produce FeCr, FeMn, SiMn, FeNi, FeSi and silicon metal alloy and for the recovery of special ferro-alloys.

Description

The technique to consider is the use of a bag filter (see Section 2.12.5.1.4) with or without injection of adsorbents.

Technical description

The main emissions from ferro-alloy processes in semi-closed furnaces are dust, metals, CO₂, NO_x, SO₂ and PCDD/F. Trace emissions include PAH.

Achieved environmental benefits

Reduction of dust and metal emissions.

Environmental performance and operational data

Bag filter

Table 8.36: Emissions from semi-closed submerged arc furnaces using bag filters

Plant	Ferro-alloy produced	Pollutant	Abatement technique	Minimum (mg/Nm ³)	Average (mg/Nm ³)	Maximum (mg/Nm ³)	Type of measurement	Monitoring frequency (number/year)	
L	SiMn	Dust	Bag filter	2	3	3	Periodic (year 2012)	Once every 2 years (3 samples)	
				1	1	1	Periodic (year 2010)		
				5	5	5	Periodic (year 2008)		
O	LC FeMn	Dust	Bag filter	0	2	20	Continuous (year 2012)	Daily	
		Pb+Cd+Hg	Bag filter	0.004	0.006	0.010	Periodic	3	
		CO	None	21	48	119	Continuous	Daily	
		SO ₂		0	0.2	1.4	Periodic	24	
		NO _x		6	52	185			
		PCDD/F	None	0.004 ng I-TEQ/Nm ³	0.006 ng I-TEQ/Nm ³	0.01 ng I-TEQ/Nm ³	Periodic	1	
O	LC FeMn	Dust	Bag filter	10.2	20.3	NR	Periodic (furnace A, year 2013)	Once every 2 years	
	LC FeMn	Dust	Bag filter	10.2	17.4	NR	Periodic (furnace B, year 2013)	Once every 2 years	
AA	FeCr	Dust	Bag filter	1.2	3.0	8.8	Continuous	Daily	
		Cr			0.3		Periodic	4	
	FeSi	Dust	Bag filter	NA	1.0	2	3.9	Continuous	Daily
		Cr				0.04		Periodic	2
		CO	None	NA		60	NA	Periodic	1
		SO ₂				120			
NO _x		245							
NB: NA = Not reported. NR = Not representative. Source: [378, Industrial NGOs 2012], [407, Euroalliages 2013]									

Table 8.37: Emissions from semi-closed submerged arc furnaces using bag filters with adsorbent injection

Plant	Ferro-alloy produced	Pollutant	Abatement technique	Minimum (mg/Nm ³)	Average (mg/Nm ³)	Maximum (mg/Nm ³)	Type of measurement	Monitoring frequency (number/year)
AB	FeCr	Dust	Two-stage bag filter, with injection of adsorbent in the second stage	3	5	7	Continuous	Daily
		Hg		< 0.0005	0.013	0.033	Periodic	5
		Pb		0.013	0.026	0.075		
		F		0.057	0.113	0.29		
		Cd		0.0003	0.0013	0.0052		
		Cr		0.0051	0.0383	0.148		
		Ni		0.0007	0.0024	0.006		
		Mn		0.006	0.0087	0.0094		
		Zn		0.05	0.133	0.23		
		VOC		6.3	7.1	7.4		
		Sb+Cr+Co+Cu+Mn+Ni+V		NA	0.16	NA		
		As+Te+Se			0.0027			
		Total cyanide			0.008			
		SO ₂			< 0.22			
		NO _x			59			
PCDD/F	0.004 ng/Nm ³							
NB: NA = Not available. Source: [378, Industrial NGOs 2012]								

Cross-media effects

Increase in energy consumption.

Technical considerations relevant to applicability

Generally applicable.

Technical restrictions can influence the type of measurements: for ferro-silicon and silicon metal, the higher temperature of the fume and the specific geometry of the exhaust of the baghouse (exhaust boxes instead of exhaust pipe) do not technically permit continuous monitoring.

Economics

No information provided.

Driving force for implementation

Reduction of dust emissions.

Example plants

Plants in SE, NO, ES and FR.

Reference literature

No reference literature provided.

8.3.3.1.3 Techniques to prevent and reduce emissions from closed submerged arc furnaces

Closed submerged arc furnaces are used for the production of FeCr, FeMn, SiMn and special ferro-alloys. Premelt plants producing FeNiMo and FeV₆₀ also apply this type of furnace.

Description

The techniques to consider are:

- wet scrubber (see Section 2.12.5.1.6);
- wet scrubber followed by mercury abatement techniques (wet ESP and adsorber);
- bag filter (see Section 2.12.5.1.4).

Technical description

Wet scrubber

Applying a wet scrubber is a technique to consider when closed furnaces produce a CO-rich exhaust gas that should be washed and dedusted at very high temperatures.

The CO-rich gas formed in the closed smelting furnace in FeCr production contains 85–90 % CO, 5–7 % H₂, 2–5 % CO₂, 2–5 % N₂ and 1–2 % H₂O, and the gas formed in the closed smelting furnaces of FeMn/SiMn production contains 40–80 % CO, 5–50 % CO₂ and 0–15 % H₂ [407, Euroalliages 2013]. The CO gas is a high-quality fuel with a very low sulphur content. Because the exhaust gas volume from smelting is small and utilised in other processes, dust emissions into the atmosphere are minimised. The gas goes to different consumption units to substitute other fuels, for instance heavy oil and liquefied petroleum gases.

Wet scrubber followed by mercury abatement techniques (wet ESP and adsorber)

When mercury is present in the raw materials used (e.g. some manganese ores), the volatile mercury is released in the processes and specific techniques are needed to reduce mercury emissions.

Bag filter

One case of a closed ferro-alloy furnace being equipped with a fabric filter instead of a wet cleaning system has been reported. This filter recovers heat from the exhaust gases and eliminates the need for a scrubbing unit. The collected dust is pelletised and then returned to the furnace, and the cleaned gas is burnt in a boiler unit.

Achieved environmental benefits

Wet scrubber

Reduction of dust and metal emissions.

Wet scrubber followed by mercury abatement techniques (wet ESP and adsorber)

Reduction of dust and mercury emissions.

Bag filter

Reduction of dust and metal emissions.

Environmental performance and operational data

The chromium(VI) content of furnace dusts is 5 ppm in the closed furnace. The furnace dust consists mainly of SiO₂, MgO, Zn and C, and smaller amounts of Cr, Fe, Al₂O₃ and CaO.

Wet scrubber

Table 8.38: Emissions from closed submerged arc furnaces using wet scrubbers (concentrations)

Plant	Ferro-alloy produced	Pollutant	Abatement technique	Minimum (mg/Nm ³)	Average (mg/Nm ³)	Maximum (mg/Nm ³)	Type of measurement	Monitoring frequency (number/year)
Z	HC FeMn	Dust	Wet scrubber	NA	0.7	NA	Estimation	NA
		Hg		0.002	0.084	0.164	Periodic	36
		Pb		NA	0.004	NA	Estimation	NA
		As			0.002			
		Cd			0.01			
		Mn			0.09			
		Zn			0.01			
M	FeMn + SiMn	Dust	Wet scrubber	NA	NA	25.4	Periodic (furnace A, years 2011 and 2012)	Once every year (1 sample)
						33.8		
						2.6	Periodic (furnace B, years 2010 and 2012)	
						7.7		
L	FeMn + SiMn	Dust	Wet scrubber	16	23.7	32	Periodic (furnace A, year 2011)	Once every 2 years (3 samples)
				11	11.7	13	Periodic (furnace B, year 2013)	
				10	12.3	14	Periodic (furnace C, year 2012)	
				30	34	39	Periodic (furnace D, year 2012)	

NB: NA = Not available.
Source: [378, Industrial NGOs 2012]

Table 8.39: Emissions from closed submerged arc furnaces using wet scrubbers (mass loads)

Plant	Ferro-alloy produced	Pollutant	Abatement technique	Minimum (kg/t)	Average (kg/t)	Maximum (kg/t)	Type of measurement	Monitoring frequency (number/year)
AE	HC FeCr	Dust	Wet scrubber	NA	0.2247	NA	Periodic	NA
		Cr			0.0021			
		Hg			0.000002			
		Pb			0.0003			
		As			0			
		Cd			0.0000007			
		Zn			0.0061			
		Ni			0.00003			
		Cu			0.000004			
		V			0.00001			
		VOC			0.0195			
		PCDD/F			2.1645 ng/t			
M	SiMn	Dust	Wet scrubber	0.042	0.0635	0.085	Periodic	2
		SO ₂		0.0001	0.00055	0.001		
M	FeMn	Dust	Wet scrubber	0.026	0.059	0.092	Periodic	2
		SO ₂		0.0002	0.0004	0.0006		
L	FeMn + SiMn	Dust	Wet scrubber	NA	0.05	0.164	Periodic	NA

NB: NA = Not available.
Source: [378, Industrial NGOs 2012]

To see the correlation between concentrations and loads, Table 8.40 includes the concentrations and loads reported by Plants M and L.

Table 8.40: Correlation between concentrations and mass loads in plants using closed furnaces

Plant	Ferro-alloy produced	Pollutant	Minimum (mg/Nm ³)	Average (mg/Nm ³)	Maximum (mg/Nm ³)	Minimum (kg/t)	Average (kg/t)	Maximum (kg/t)
M	FeMn + SiMn	Dust	NA	NA	25.4	NA	NA	0.022
					33.8			0.026
					2.6			0.003
					64.1			0.085
L	FeMn + SiMn	Dust	16	23.7	32	0.034	0.050	0.067
			12	23.3	35	0.019	0.037	0.057
			20	25.7	31	0.031	0.036	0.044
			11	11.7	13	0.01	0.012	0.014
			13	38.3	58	0.015	0.050	0.075
			10	18.7	31	0.007	0.013	0.02
			10	12.3	14	0.014	0.017	0.02
			9	11	13	0.011	0.013	0.015
			10.2	13.1	15	0.012	0.014	0.018
			30	34	39	0.042	0.047	0.052
			12	18.3	30	0.019	0.028	0.045
			26	38	55	0.035	0.047	0.065

NB: NA = Not available.
Source: [378, Industrial NGOs 2012]

*Wet scrubber followed by mercury abatement techniques***Table 8.41: Emissions from closed submerged arc furnaces using wet scrubbers followed by mercury abatement techniques**

Plant	Ferro-alloy produced	Pollutant	Abatement technique	Minimum (mg/Nm ³)	Average (mg/Nm ³)	Maximum (mg/Nm ³)	Type of measurement	Monitoring frequency (number/year)
I	LC SiMn + HC SiMn	Dust	Venturi washers, boiler and mercury treatment plant (wet scrubbing)	2.5	3.35	4.0	Periodic	4
J	HC FeMn	Dust	Venturi, wet ESP and adsorber	NA	2	NA	Calculated	NA
K	LC FeMn + MC FeMn + SiMn	Dust	Venturi, wet ESP and adsorber	NA	2	NA		

NA = Not available.
Source: [378, Industrial NGOs 2012]

*Bag filter***Table 8.42: Emissions from closed submerged arc furnaces using bag filters**

Plant	Ferro-alloy produced	Pollutant	Abatement technique	Average (mg/Nm ³)	Type of measurement
AC	FeV + FeMo	Dust	Bag filter	0.10	Periodic
				0.16	
				0.10	

Source: [378, Industrial NGOs 2012]

Cross-media effects*Wet scrubber*

Generation of a washing liquid and a sludge that require further treatment. Water from the gas scrubbers will contain different quantities of suspended solids. These must be removed before the water is recirculated or discharged. The inert waste water sludge can be used for some construction applications or landfilled. The contaminated water is pumped to a combination of thickeners and settling ponds. Since the particles are mostly extremely fine, it is necessary to add a flocculant to assist settling in thickeners. The water will also contain a small amount of cyanides. This cyanide level can be reduced by using the scrubber water for slag granulation, which leads to evaporation and oxidation of most of the cyanides. Further reduction can be achieved by long retention times in large ponds, allowing time for oxidation of the cyanides before discharge, and also allowing time for the settling of suspended solids to a low level. Cyanide removal utilises the heat content of the slag.

Technical considerations relevant to applicability

Wet scrubbers are generally applicable in closed submerged arc furnaces.

It was reported that bag filters can only be applied in closed submerged furnaces in which the exhaust gas is oxidised (and therefore has a low CO content) before being extracted from the furnace, because otherwise there would be a risk of explosion.

Economics

No information provided.

Driving force for implementation

Reduction of dust emissions.

Example plants

- Wet scrubber: Plants in NO, ES, FR and FI.
- Wet scrubber followed by mercury abatement techniques: A plant in Norway.
- Bag filter: A plant in Austria.

Reference literature

[369, Treibacher Industries AG 2008]

8.3.3.1.4 Techniques to prevent and reduce emissions from the closed plasma dust process

The plasma dust process is used for the processing of steel mill residues (mostly stainless steel EAF dust). It processes fine-grained material without the need for agglomeration, but requires dry feed.

Description

The techniques to consider are:

- bag filter (see Section 2.12.5.1.4);
- wet scrubber (see Section 2.12.5.1.6);
- wet ESP (see Section 2.12.5.1.2);
- selenium filter (see Section 2.12.5.5).

Technical description

In one plant in Sweden, the process gas is cooled and cleaned in a three-stage Venturi scrubber system, followed by a wet ESP. Process gas that is not recycled to the shaft furnace is treated in a mercury filter unit (selenium filter). The cleaned gas is then combusted/used in the drying of raw materials, in water boilers, or for energy delivery to the communal remote heating network, or is flared (excess gas). The raw material drying system exhaust gases are cleaned in two bag filters.

The gases from all emission points where there is a risk of dusting/emissions, including the furnace hall, are collected and cleaned in two bag filters.

Achieved environmental benefits

Reduction of emissions to air.

Environmental performance and operational data

The Swedish plasma plant produces approximately 60 000 t/yr of products (Ni, Mo, Cr, Mn and Fr) from metal-bearing fines of 70 000 t/yr.

Total dust emissions from this plant are reported in Table 8.43.

Table 8.43: Emissions from the closed plasma dust process

Source of dust emissions	Dust (mg/Nm ³)	Dust (kg/yr)	kg/t dry raw material
Flare	1.3	13.1	0.003
After boilers	1.0	34	
After bag filter	0.12	131.3	
Total	NA	178.4	
NB: NA = Not applicable.			

Dust emissions from diffuse sources are estimated to be 30–70 kg/yr.

The mercury level after the selenium filter is 0.009 mg/Nm³, corresponding to a 94 % mercury removal efficiency.

Cross-media effects

Increase in energy consumption.

Technical considerations relevant to applicability

Generally applicable.

Economics

No information provided.

Driving force for implementation

No information provided.

Example plants

A plant in Sweden.

Reference literature

No reference literature provided.

8.3.3.1.5 Techniques to prevent and reduce emissions from multiple hearth furnaces

In the ferro-alloy industry, multiple hearth furnaces (MHF) are used to roast sulphidic ore concentrates into oxides. In the molybdenum industry, the multiple hearth furnace is the most commonly used technology to convert molybdenite (the sulphidic concentrate) into molybdenum oxides (roasted molybdenum concentrate or RMC).

Description

The techniques to consider are the use of dry dedusting (settling chambers, cyclones and dry ESP), wet dedusting (scrubber, water condenser and droplet eliminator), sulphuric acid process or H₂SO₄ recovery (SO₂ abatement) and a mist eliminator.

Technical description

For roasting processes in multiple hearth furnaces, the main environmental issues to be addressed are the dust control and the SO₂ abatement. The furnace and most of the gas treatment are kept under pressure in order to avoid diffuse emissions.

Settling chambers, cyclones and dry ESP (dry dedusting)

The main objective of this technique is to remove the coarse and fine dust particles, and this block consists of a configuration of common techniques like settling chambers, cyclones and a dry ESP.

Scrubber, water condenser and droplet eliminator

The main objective of this technique is to remove the finest dust particles and the volatile components like acids (HCl, HF) and metal compounds (selenium compounds, arsenic oxides).

Sulphuric acid process or H₂SO₄ recovery

After dry and wet dedusting, the process gas is clean, except for its SO₂ content. Many techniques could be used for the SO₂ removal. For molybdenite roasting, SO₂ can be abated by sulphuric acid (H₂SO₄) recovery. If the SO₂-containing process gas is treated in this way, the wet sulphuric acid (WSA) process is most suitable. If the SO₂-containing process gas is enriched by burning sulphur, the classical sulphuric acid process can be used. The difference between the WSA process and the classical sulphuric acid process is described in Chapter 2.

Mist eliminator

A mist eliminator is usually applied after the sulphuric acid plant. Either candle filters (Brink filter) or wet electrostatic precipitators can be used depending on the acid mist concentration and the trade-off between the mist removal yield and the energy consumption (and hence CO₂ emission).

Achieved environmental benefits

Settling chambers, cyclones and dry ESP (dry dedusting)

Reduction of coarse and fine dust emissions.

Scrubber, water condenser and droplet eliminator

Reduction of the finest dust, volatile components like acids and metal compounds emissions.

Sulphuric acid process or H₂SO₄ recovery

Reduction of SO₂ emissions.

Mist eliminator

Reduction of acid mist concentration.

Environmental performance and operational data

The dust emission from roasting processes equipped with a sulphuric acid plant is always very low because, after the dry and wet dedusting, the catalytic converter beds catch most of the remaining dust particles. This is actually a self-regulating loop. In order to prevent the catalytic converter beds from blocking, the dry and wet dedusting equipment will be operated and designed so as to maximise the dust removal. And the reported values from dust measurements at the stack are low (< 2 mg/Nm³).

As in many metallurgical processes, both the gas volume and SO₂ concentration from roasting furnaces vary significantly over time. This explains why the SO₂ abatement cannot meet the same standards as regular sulphuric acid production, where sulphuric acid is intentionally produced under very stable process conditions and not as a result of a SO₂ abatement technique. Nevertheless, modern acid plants connected to molybdenite roasters can keep the SO₂ emission in a steady state, at a yearly average of around 500 mg/Nm³.

The mist eliminator controls the acid mist emission in a typical range of 5–20 mg SO₃/Nm³, and a maximum of 50 mg/Nm³. These levels result in an almost invisible plume at the stack.

Cross-media effects

- Increase in energy consumption (dry and wet dedusting and SO₂ abatement techniques). The SO₂ abatement by a sulphuric acid plant not only requires electrical energy to compensate for the pressure drops, but also thermal energy (from natural gas or fuel) to compensate for the heat losses in the process. Electricity consumption is typically 600 kWh/t of SO₂ removed, and gas or fuel consumption is typically 450–650 kWh/t of SO₂ removed.
- High pressure drop over the system (candle filter). Typical values are 20–25 mbar.

Technical considerations relevant to applicability

Generally applicable.

Economics

Although sulphuric acid is a commercial product, the sales of it do not cover its production cost, or even the operational costs (energy, labour, maintenance, consumables). The cost of the SO₂ abatement is hence borne by the income from the roasting activity.

Driving force for implementation

- Reduction of environmental impact.
- Air quality standards.

Example plants

Plants in Belgium and Niger.

Reference literature

[104, Ullmann's Encyclopedia 1996]

8.3.3.1.6 Techniques to prevent and reduce emissions from refractory-lined crucibles

Refractory-lined crucibles are used in the production of ferro-molybdenum and ferro-vanadium.

Description

The techniques to consider are the use of settling chamber, cyclone, (see Section 2.12.5.1.3) and a bag filter (see Section 2.12.5.1.4).

Technical description

Whether a fixed reaction location is used, or a carousel system of the refractory-lined crucibles, the fumes treatment is basically similar, and consists of classical dedusting units such as a settling chamber, cyclones and a bag filter. In order to limit the temperature at the bag filter (to protect the fabric bags), secondary air is sucked into the system, mostly around the reaction site itself. This improves the dedusting performance at the reaction location. The addition of fluxes may cause the emission of gaseous components that will not be collected by the bag filter. These should be minimised by careful control of flux additions, and may be abated by a wet or dry scrubbing technique if necessary.

Achieved environmental benefits

Reduction of dust and metal emissions.

Environmental performance and operational data

Table 8.44: Emissions from refractory-lined crucibles

Plant	Ferro-alloys produced	Pollutant	Abatement technique	Minimum (mg/Nm ³)	Average (mg/Nm ³)	Maximum (mg/Nm ³)	Type of measurement	Monitoring frequency (number/year)
A	FeMo	Dust	Bag filter	0.2	0.92	1.4	Continuous	Hourly
		Dust		0.2	1.69	4.77	Periodic	12
X	FeMo	Dust	Bag filter	2	2.15	2.3	Periodic	2
AC	FeMo + FeV	Dust	Bag filter	NA	< 2	NA	Periodic	NA
		PAH			35 µg/Nm ³			
		Organic carbon			2.7			
		PCDD/F			< 0.001 ng I-TEQ/Nm ³			

Source: [378, Industrial NGOs 2012]

In the case of ferro-molybdenum, it is possible to maintain production for longer operating periods. As a consequence, the implemented technique requires higher environmental protection. For example, longer operating hours lead to increased dust formation and, as a consequence, a higher demand on the filter systems.

Cross-media effects

Increase in energy consumption. In order to avoid the emission of dust and vapours from the crucible, a fan has to create a negative pressure under the hood or in the reaction chamber (depending on the gas collection and abatement technique). Due to the nature of the batch-type reactions, the fan must cope with high peaks in volume, and hence uses a lot of power to maintain positive differential pressure across the dedusting unit (electrical motors of 200 kW are not unusual).

Technical considerations relevant to applicability

Generally applicable.

Economics

No information provided.

Driving force for implementation

- Reduction of environmental impact.
- Air quality standards, mainly related to dust.

Example plants

Plants in AT, BE and UK.

Reference literature

[104, Ullmann's Encyclopedia 1996], [369, Treibacher Industries AG 2008]

8.3.3.1.7 Techniques to prevent and reduce emissions from rotary kiln furnaces

The production of ferro-nickel from primary raw material is carried out exclusively by the rotary kiln electric furnace process.

Description

The technique to consider is the use of an ESP (see Section 2.12.5.1.1).

Technical description

The principal environmental management technique for the emissions produced by the rotary kilns is entrapment of the dust contained in the exhaust gas ($\sim 150 \text{ g/Nm}^3$) using ESPs.

The filtering of dusts is most efficient when the dusts are easily ionised, which is the case with the fines from crude. However, calcinated dusts are more resistant to electrofiltration. The origin of dusts from the process is presented in Table 8.45.

Table 8.45: Origin of dust in the process

Origin of dust	Quantity (%)
Predried ores	65
Heat-sensitive FD	29
Coal dust	6

Emission standards can be met by the management of the process, e.g. by increasing or decreasing flow pressures where applicable, and by a combined use of fuel oil and coal.

Since the combined presence of SO_3 and water in emissions could produce sulphuric acid, it is important that the temperature of the emissions is maintained above 110°C (dew point of the acid):

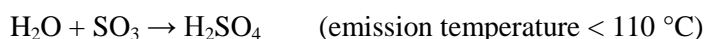

Achieved environmental benefits

Reduction of dust emissions.

Environmental performance and operational data

The use of an ESP can significantly reduce the dusts generated by the process (efficiencies of $> 99.67\%$ have been reported).

Cross-media effects

No information provided.

Technical considerations relevant to applicability

Generally applicable.

Economics

No information provided.

Driving force for implementation

- To meet environmental standards.
- Recuperation of dust with a high metal content for recycling in the furnaces.

Example plant

Eramet SLN (New Caledonia).

Reference literature

[110, Anthony, T. 1997]

8.3.3.2 Techniques to reduce emissions in ferro-alloy production from tapping

Description

The technique to consider is the use of appropriate hooding systems (see Section 2.12.4.3) and a bag filter (see Section 2.12.5.1.4).

Technical description

A pneumatic or hydraulic drill could be used to open the taphole of the smelting furnace (not applicable for silicon). Oxygen lancing is also used, either as the only method or as a back-up or complement to drilling. A tapping gun helps to remove blockages. The taphole is closed after tapping using a mud gun or shutting paste/clay [226, Nordic Report 2008]

The most frequently used technique for tapping is cascade tapping for slag processes such as FeMn, SiMn and FeCr production (not applicable for silicon metal or FeSi). In this case, the metal and slag are tapped together in the same vessel. Generally, the lower density slag floats on the top of the bath and overflows via a weir into a separate ladle as the bath fills. It should be noted that silicon slag has a higher density than silicon metal.

Tapping fumes are comprised of fumes escaping from the furnace process through the taphole, fumes from oxygen lancing, dust from drilling and fumes from the vaporised slugs if a tapping gun is used. These fumes consist mainly of oxides of the metals involved in the smelting process. The design of the hooding system should take into account the need for access for charging and other furnace operations and the way the source of process gases changes during the process cycle [140, Ferro-Alloy Expert Group 1998].

The design of appropriate hooding systems to collect fumes from the tapping areas is very much dependent on the site-specific arrangements of the tapping. Therefore, a large number of different hooding designs exist.

As an example, at one Eramet plant in Norway, metal flows out of the taphole on a short inclined runner into a tapping ladle through an opening in the tapping platform (platform around the furnace located about 40 cm below the taphole level). The tapping ladle is set on a car, located under the tapping platform during the tapping. Afterwards, the car is moved away from the furnace in order for a crane to be able to pick up the ladle. During the tapping, the ladle is enclosed under the platform and the dust is collected by a fan. There is a hood located above the taphole: air is blown downwards from the edges of the hood (air curtain) in order to prevent the dust from escaping and the dust-laden air is sucked out by a fan connected to the hood. The air is filtered in a bag filter. Some further improvements include placing a trolley to direct the dust from under the tapping floor towards the primary hood (hugely limiting the amount of dust in the working environment under the secondary hood) and having either a vertical physical wall or a vertical air curtain at the end of the tapping floor to prevent dust escaping from below the tapping floor on the outside.

New hoods or improvements to existing hoods can be designed to be as efficient as possible at collecting the dust by using computerised fluid dynamics (CFD) techniques.

In silicon and ferro-silicon furnaces, a hooding system like the one shown below can be used.

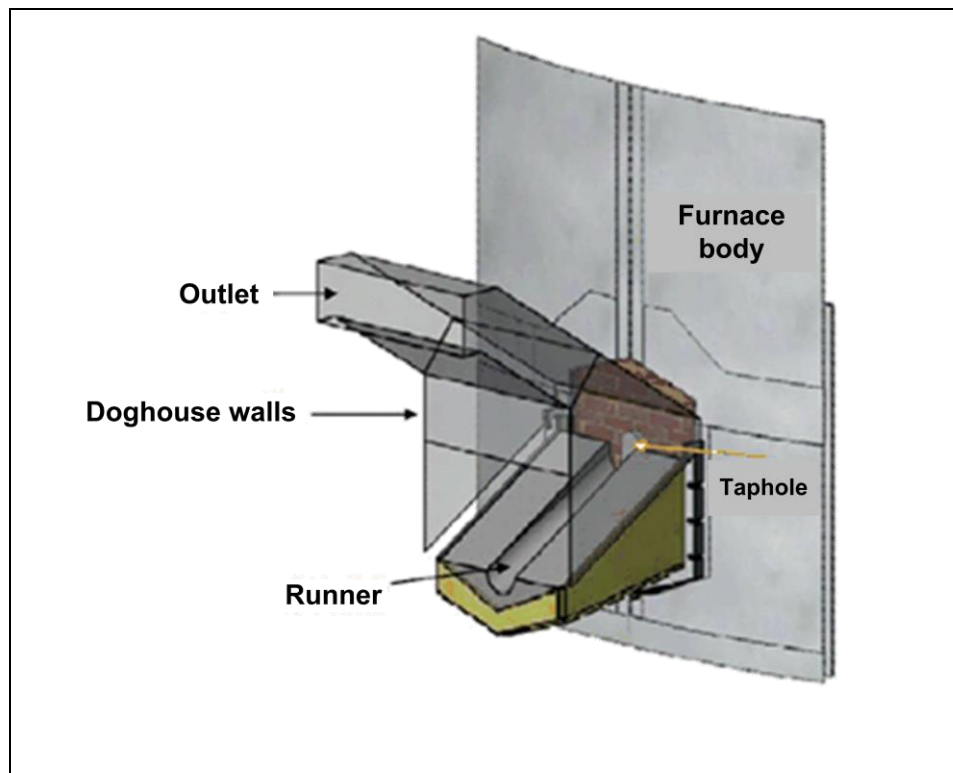

Figure 8.21: Hooding system used in some silicon and ferro-silicon furnaces

The cleaning equipment used for tapping fumes is a bag filter. This can be a separate filter or a filter that also cleans the fumes from metal casting or the furnace off-gas.

The dedusting equipment is composed of various hoods located above the taphole of the furnace.

Achieved environmental benefits

- Reduction of dust emissions.
- The use of appropriate hooding systems also results in better working conditions.

Environmental performance and operational data

The collection efficiency is as follows:

- Main hood: 96 %.
- Hood corresponding to the pouring of metal into the ladle: 86 %.
- Runner hood (see Figure 8.21): 100 %.
- Collection efficiency: difficult to directly measure. Data calculated using CFD modelling estimate the efficiency as varying between 70 % and 90 %.
- Flow rate: 100 000 Nm³/h.

Table 8.46: Dust emissions from tapping

Plant	Ferro-alloy produced	Pollutant	Abatement technique	Minimum (mg/Nm ³)	Average (mg/Nm ³)	Maximum (mg/Nm ³)	Type of measurement	Monitoring frequency (number/year)
Z	HC FeMn	Dust	Bag filter	0.3	0.6	1.2	Periodic	36
K	LC FeMn + MC FeMn + SiMn		Bag filter	0.02	0.04	0.05	Periodic	4
			Bag filter	0.03	0.035	0.04		
L	FeMn + SiMn		Bag filter	5	5.6	7	Periodic (furnace A, years 2009 and 2012)	Once every 3 years (3 samples)
				3	3	3		
				4	4	4	Periodic (furnace B, years 2010 and 2012)	
				1	1	1		
Y	SiMn		Bag filter	0.23	4.3	Invalid data (higher than ELV)	Periodic	
I	LC SiMn + HC SiMn		Bag filter	2.80	3.65	4.20	Periodic	4
O	FeMn		Bag filter	1	1.6	2.4	Periodic (year 2012)	Once every year (3 samples)
O	SiMn	Bag filter	3.6	8.1	13.6*	Periodic (year 2012)	Once every year (3 samples)	
M	Si	Bag filter			3	Periodic (year 2012)	Once every year (1 sample)	
					30	Periodic (year 2012)		

* Values reported for four other different reference years are always below 5 mg/Nm³.
Source: [378, Industrial NGOs 2012.]

Plant-specific data show that using a bag filter at this stage allows dust emissions < 5 mg/Nm³ to be achieved.

Cross-media effects

- Increase in energy consumption (fans).
- The efficient evacuation of gases requires a closed tapping area, resulting in increased heat exposure for workers.

Technical considerations relevant to applicability

Bag filters are generally applicable.

The hooding configuration is very much dependent on the site-specific arrangements of the tapping.

Economics

No information provided.

Driving force for implementation

- Reduction of emissions.
- Reduction of negative impact of dust/fumes on workers in the furnace building.

Example plants

Plants in FR, ES, DE, NO, SE and FI.

Reference literature

[140, Ferro-Alloy Expert Group 1998] [141, Elkem Asa 1998], [197, Kantola, E. 1999], [199, EnviroSense 1995], [226, Nordic Report 2008], [255, VDI 2010].

8.3.4 Casting, refining and alloying in ferro-alloy production**8.3.4.1 Techniques to reduce emissions in ferro-alloy production from casting, transfer and refilling operations****Description**

The technique to consider is the use of appropriate hooding systems (see Section 2.12.4.3) and a bag filter (see Section 2.12.5.1.4).

Technical description

Casting fumes are fumes from all exposed metal and slag surfaces. These fumes consist mainly of oxides of the metals involved in the smelting process. The design of the hooding system should take into account the need for access for charging and other furnace operations and the way the source of process gases changes during the process cycle [140, Ferro-Alloy Expert Group 1998].

The design of appropriate hooding systems to collect fumes from the casting areas is very much dependent on the site-specific arrangements of the casting. Therefore, a large number of different hooding designs exist. There may be a separate filter or a filter that also cleans the fumes from metal tapping or the furnace off-gas.

In some cases, the liquid metal is poured into closed pits where the fumes are collected and sent to a bag filter. To guarantee the best closure of the pits, a dumper is used to pour the slag. This is the process in which most fumes are generated. In the case of molten ferro-chrome and integrated plants, the liquid metal can be used directly in steel production, minimising casting and its associated dust emissions. Nevertheless, since it is not possible to perfectly balance ferro-chrome production with the steel plant demand at all times, metal casting facilities must be available at the integrated ferro-chrome production site.

Bag filters are commonly used.

Achieved environmental benefits

Reduction of diffuse dust emissions, resulting also in better working conditions.

Environmental performance and operational data

Table 8.47: Dust emissions from casting

Plant	Ferro-alloy produced	Pollutant	Abatement technique	Average (kg/h)	Average (mg/Nm ³)	Type of measurement	Monitoring frequency (number/year)
U	Silicon	Dust	Bag filter	0.1	1.1	Periodic	1
		Particulate metals		0.02	0.15		
		PAH		0.0003	0.003		
		VOCs		2.2	20		
		SO ₂		0.04	0.4		
		NO _x		5.7	51		

Source: [378, Industrial NGOs 2012]

Cross-media effects

Increase in energy consumption (fans).

Technical considerations relevant to applicability

Bag filters are generally applicable.

In existing plants, the use of hooding systems for casting operations is not always technically possible due to the space requirements. In this case, the technical equipment such as conveyors and overhead cranes can be used to carry the ladles to the place where the hooding system can be operated.

The use of molten ferro-chrome in a steel production plant is only possible if the alloy production is integrated with the stainless steel production.

Economics

No information provided.

Driving force for implementation

Reduction of emissions.

Example plant

A plant in France.

Reference literature

[140, Ferro-Alloy Expert Group 1998], [255, VDI 2010], [408, Kadkhodabeigi M. 2011]

8.3.4.2 Techniques to reduce diffuse emissions in ferro-alloy production from refining and alloying

The principles of process control discussed in Section 2.12.3 are applicable to the production processes used in this metal group. Some of the furnaces and processes can be improved by the adoption of many of these techniques. Technically, bag filters can also be applied at this stage.

8.3.5 Ferro-alloy post-furnace operations

8.3.5.1 Techniques to reduce emissions from size reduction of products

Description

The technique to consider is the use of a bag filter (see Section 2.12.5.1.4).

Technical description

After tapping, casting and cooling of the liquid slag and ferro-alloy, it is crushed and screened in order to adapt its size according to customers' specifications. This size reduction generates dust. The crushing facilities are closed buildings built in a manner that minimises noise emissions and vibrations. Bag filters clean the suction air of crushers. When mobile equipment is used for the handling of dry and dusty material or the crushing of dry slags, dust emissions can be controlled by the use of a water spraying system. The systems used are similar to those described in Section 8.3.2.1.

In the case of ferro-chrome, the cast material feeds into an integrated crushing and screening plant to produce the wide range of product sizes required. These operations are potentially a source of dust emissions and consequently require covering. Extraction and bag filters are used and the collected dusts are reused.

As an example, in Sweden and Finland, the material is handled in a covered building where the size reduction take place, with integrated crushing, screening and partly enclosed conveyor belts. Dust suction from the crusher, screen and conveyor is installed. The dust is filtered by a bag filter at 90 000 Nm³/h. The amount of air needed depends on different conditions (e.g. the size of the building).

Ferro-molybdenum and FeV₈₀ are also used in the production of welding electrodes. The undersized particles of the individual alloys are pre-ground to a grain size of < 3 mm in the pulveriser plant. The material is transferred into conical transport containers. All intermediate fractions are lifted via an assembly-hall crane to the respective feed hopper. The next grinding step occurs in the Palla (rod) mill. The obtained powdery alloys are control-sieved via a double deck screen. After sampling and analysis, these alloys are stored in metal containers.

Fines produced from the size reduction of products can be commercialised and are stored in closed silos.

Achieved environmental benefits

Reduction of dust and metal emissions.

Environmental performance and operational data

In Table 8.48, a ferro-chrome plant reports figures for the recovery of very fine products in the crushing and screening station.

Table 8.48: Recovery of very fine products in the crushing and screening station of a ferro-chrome plant

Year	Total amount of FeCr crushed (t)	Very fine products recovered (t)	
		Crushing station	Screening station
2010	142 100	389	136
2011	131 600	319	120

In Table 8.49 the dust emissions from post-furnace size reduction are reported.

Table 8.49: Dust emissions from post-furnace size reduction

Plant	Ferro-alloy produced	Pollutant	Abatement technique	Minimum (mg/Nm ³)	Average (mg/Nm ³)	Maximum (mg/Nm ³)	Type of measurement	Monitoring frequency (number/year)
AE	FeCr	Dust	Bag filter		< 5	< 10	Continuous	Hourly
I	LC SiMn + HC SiMn			8.3	8.63	9.0	Periodic	4
K	LC FeMn + MC FeMn + SiMn			0.26	1.05	2.14	Periodic	21
S	Silicon				4.01		Periodic	1
T	FeSi			1.6	1.6	1.7	Periodic	3
X	FeMo			0.5	0.53	0.55	Periodic	2
				0.50	0.85	1.20		
AC	FeV + FeMo				< 3		Periodic	
P	Si (crusher 1, year 2012)			1.15	1.3	1.51	Periodic	2
P	Si (crusher 2, year 2012)			0.94	1.0	1.02	Periodic	
L	FeMn + SiMn (crusher 1, year 2013)			2	2.3	3	Periodic	Once every 2 years (3 consecutive measurements)
L	FeMn + SiMn (crusher 2, year 2011)			3	3	3	Periodic	

Source: [378, Industrial NGOs 2012]

Cross-media effects

Increase in energy consumption (fans).

Technical considerations relevant to applicability

Generally applicable.

Economics

No information provided.

Driving force for implementation

- Reduction of dust emissions.
- Collection of saleable dust.

Example plants

Plants in AT, BE, FI, FR, NO and SE.

Reference literature

[369, Treibacher Industries AG 2008]

8.3.5.2 Techniques to reduce diffuse emissions from the handling, storage and transport of very fine products**Description**

The techniques to consider are:

- general techniques to avoid diffuse emissions (closed pneumatic transfer system, storing and transporting in enclosed bins), which are considered in Section 2.12.4 and in the Emissions from Storage BREF [290, COM 2006];
- densification of silica powder and other dust collected in bag filters, see Section 2.12.5.1.4.

Technical description

Handling and transportation of dust and very fine products from the production process are carried out using closed systems, in particular closed conveyors, pneumatic transportation, and packaging in closed big bags.

To handle silica fumes (micro-silica) and other ferro-alloy filter dust, a densification step is often performed to densify the material. The process transforms a powder into small spheres of about 0.5–1 mm in diameter.

Achieved environmental benefits

- Reduction of diffuse dust emissions.
- Reduction of transport impact (densification of silica powder).

Environmental performance and operational data

The bulk density of raw silica dust is less than 0.2 t/m^3 . The process of densification increases the bulk density to $0.5\text{--}0.6 \text{ t/m}^3$.

Cross-media effects

Densification results in an increase in energy use.

Technical considerations relevant to applicability

Closed pneumatic transfer, packing in storage bins and storing and transporting in storage bins are generally applicable.

Densification is applicable to new and existing plants where silica fume, silico-manganese powder, furnace dust and manganese and iron oxides need to be handled.

Economics

The use of compressed air for pneumatic transfer causes increased operating costs.

The maintenance of bins also generates extra costs. At the same time, improved recovery of very fine products increases sales revenues.

Densification of silica powder helps reduce transport costs by about 65 %.

Driving force for implementation

- Reduction of emissions and waste generation.
- Increase in sales revenues.

Example plants

- General techniques to reduce diffuse emissions: Plants in FR, ES, SE and FI.

- Densification of silica powder and other dust collected in bag filters: A plant in Norway.

Reference literature

[141, Elkem Asa 1998]

8.3.5.3 Techniques to reduce emissions in ferro-alloy production from packaging

Description

The techniques to consider are:

- general techniques to avoid diffuse emissions (packing in enclosed bins), see Section 2.12.4;
- bag filter, see Section 2.12.5.1.4.

Technical description

Ferro-alloys can be transported in bulk, or packaged in drums or big bags. Loading of bulk ferro-alloy is done outdoors or in a closed building to minimise diffuse dust emissions. Hooding can also be used above the loading point to collect diffuse emissions.

Primary products can be screened indoors to produce a less dusty product range. Bag filters are used to reclaim metal during crushing, screening and conveying. Undersized material is collected in an enclosed silo with dedusting equipment (bag filter). Dusts are packed into the enclosed bins.

Covered trucks are used for transportation.

For shipping overseas as bulk in containers, a conveyor belt or front-end loader is used to charge the product into the containers where it is stockpiled and transported onwards.

For molten ferro-alloy used in stainless steel production, liquid ferro-alloy is transferred after tapping and skimming to an adjacent steel melting shop by ladle car.

Achieved environmental benefits

Reduction of dust emissions.

Environmental performance and operational data

Table 8.50: Dust emissions from packaging

Plant	Ferro-alloy produced	Pollutant	Abatement technique	Average (mg/Nm ³)	Type of measurement	Monitoring frequency (number/year)
U	Si	Dust	Bag filter	3.4	Periodic	1
		Particulate metals		0.067		
AC	FeV + FeMo	Dust	Bag filter	1.73	Periodic	NA
				0.91		

NB: NA=not available.
 Source: [378, Industrial NGOs 2012]

Cross-media effects

Increase in energy consumption (fans).

Technical considerations relevant to applicability

Generally applicable.

Economics

No information provided.

Driving force for implementation

Reduction of dust emissions.

Example plants

Plants in France and Austria.

Reference literature

No reference literature provided.

8.3.5.4 Techniques to reduce emissions in ferro-alloy production from slag treatment**Description**

In the case of ferro-chrome production, the technique to consider is the use of a wet ESP (see Section 2.12.5.1.2).

Technical description

In general, slag can be poured directly into the slag pit or can be granulated in a granulator depending on its final use. If granulation is needed, the process pours the slag directly into a water bath or, by spraying water onto a slag pit or teeming station if needed, the fumes are collected using a hood and are sent to an abatement system. These techniques all reduce emissions of fumes and dust. The water used needs treatment in a settler or with similar technology to remove particles, and heat can also be recovered. The water can be reused as quenching water. Slag is processed where possible to recover metal. When the slag is granulated by the spraying water there is no waste water as all of it will be evaporated.

Fumes from slag granulation from ferro-chrome furnaces are abated in a wet ESP.

There are also techniques to recover alloys from the slag by crushing and further enrichment of the alloys using the different densities of the slag and the alloy.

Achieved environmental benefits

Reduction of dust emissions.

Cross-media effects

Waste water generation when a water bath used.

Environmental performance and operational data

No information provided.

Technical considerations relevant to applicability

Generally applicable.

Economics

Investment in slag granulation and crushing enables the sale of all the ferro-chrome slag as a by-product. No landfill is needed.

Driving force for implementation

Reduction of emissions.

Example plant

A plant in Finland.

Reference literature

No reference literature provided.

8.3.6 Waste water

8.3.6.1 Techniques to prevent waste water

Description

The technique to consider is the reuse of cooling water and treated waste water, including rainwater, within the process.

Technical description

Most ferro-alloys production plants use a closed-circulation system for cooling, to minimise water consumption. The recirculation of waste water to certain processes is possible, to replace raw water and to avoid waste water.

In cold climates in northern Europe, non-contact cooling water is used in once-through systems without a significant increase in temperature in the receiving water system. The water is discharged back to a river or sea. In cold climates during wintertime, it is also possible to use the warm cooling water for de-icing purposes (e.g. to prevent ice formation in the harbour, hence decreasing the use of icebreaker ships and their emissions, etc.).

Run-off water from landfills of separated ferro-chrome dust from the filters can be minimised by covering the landfill. The rainwater is then separated from the drainage water, which may have to be treated to reduce the amount of chromium before discharge to a receiving water body.

Achieved environmental benefits

- Reduction of water consumption.
- Prevention of water pollution.

Environmental performance and operational data

No information provided.

Cross-media effects

Increase in chemical consumption.

Technical considerations relevant to applicability

Generally applicable.

Economics

No information provided.

Driving force for implementation

No information provided.

Example plants

All plants.

Reference literature

No reference literature provided.

8.3.6.2 Waste water treatment

Description

The techniques to consider are the ones described in Section 2.12.6.2.

Technical description

Waste water should be treated, prior to its discharge, in order to remove or reduce the concentration of dissolved metals and solids and other components.

Water treatment is needed in the processes using wet scrubbers and in granulation processes, since suspended solids should be removed before the water is recirculated. To reach acceptable values of harmful components, it may sometimes be necessary to treat the bleed from the scrubbing water cycle. This may be achieved by using techniques described in Section 2.12.

With a plasma arc furnace, water from the wet ESP, granulation water and water from the smelter area are collected and treated in a WWTP prior to discharge.

Achieved environmental benefits

Minimisation of the emissions of chromium(VI) and other harmful compounds.

Environmental performance and operational data

Table 8.51: Emissions to water from Plant AB (ferro-chrome)

Water source	Waste water treatment	Pollutant	Unit (mg/l)			Method to obtain data	Measurement frequency (number/year)
			Min.	Avg.	Max.		
Rainwater and process water (after treatment, approx. 95 % is reused for cooling metal and slag, humidification of dust to be processed, etc.)	Physico-chemical treatment by flocculation and coagulation to pH 8–9 for the precipitation of dissolved metals. Use of ferrous sulphate to reduce Cr(VI) to Cr(III)	Pb	< 0.02	< 0.02	< 0.02	Single random sampling	3
		Zn	0.157	0.376	0.717		
		Cu	0.023	0.05	0.076		
		Hg	< 0.0005	< 0.0005	< 0.0005		
		Cd	< 0.01	< 0.01	< 0.01		
		As	< 0.02	< 0.02	< 0.02		
		Ni	0.05	0.07	0.09		
		Cr tot	0.05	0.15	0.20		
		Cr(VI)	0.01	0.02	0.04		
		Ntotal	1.85	2.16	2.29		
		BOD ₅	11	12.74	15		
		COD	58	67.3	77		
		Suspended solids	8	9	10		
		pH	7.7	7.85	7.95		
		Hydrocarbons	0.9	0.97	1.1		
Fluorides	2.5	3.6	6.5				
Total cyanide	< 0.01	< 0.01	< 0.01				

Source: [378, Industrial NGOs 2012]

Table 8.52: Emissions to water from Plant AC (ferro-chrome)

Water source	Waste water treatment	Pollutant	Emissions ⁽¹⁾ (mg/l)			Method to obtain data	Measurement frequency (number/year)
			Min.	Avg.	Max.		
Process water; cooling water; scrubber waste water from the sintering plant; FeCr smelters	Waste water is collected and led to the settling ponds either directly or through filtration (sand filters) and centrifuge treatment. The settling pond system contains several ponds where solids and metals are settled. Flocculants are added to the water. Water is returned to the process from the last pond. Overflow is discharged	Zn	0.11	0.26	0.83	Weekly composite sampling	29
		Ni	0.01	0.03	0.05		
		Cr tot ⁽²⁾	0.05	0.09	0.15		
		Suspended solids	2	6.11	11.8		

⁽¹⁾ The emissions to water are reported from the common sewer of a steelworks and a ferro-chrome plant.
⁽²⁾ Concentrations in ferro-chrome production are 0.2–0.4 mg/l (as a weekly average).
Source: [378, Industrial NGOs 2012]

Table 8.53: Emissions to water from Plant N (ferro-silicon)

Water source	Waste water treatment	Pollutant	Unit (mg/l)			Method to obtain data	Measurement frequency (number/year)
			Min.	Avg.	Max.		
Surface run-off water	Physical sedimentation. No chemical treatment	Zn	0.038	0.31	0.598	Continuous composite sampling	Daily average
		Cu	0.009	0.019	0.030		
		Hg	< 0.0001	< 0.0001	< 0.0001		
		Mn	0.20	0.57	1.3		
		Cr(VI)	< 0.005	< 0.05	< 0.05		
		Al	< 0.1	0.2	0.41		
		BOD ₅	< 1	1.83	4		
		COD	< 5	13.86	24		
Suspended solids	< 2	11.24	47				

Source: [378, Industrial NGOs 2012]

Table 8.54: Emissions to water from Plant U (silicon)

Water source	Waste water treatment	Pollutant	Unit (mg/l)			Method to obtain data	Measurement frequency (number/year)
			Min.	Avg.	Max.		
Cooling water	Sedimentation tank	BOD ₅	< 3	4.5	6	Periodic composite sampling	2
		COD	< 30	41	52		
		Suspended solids	NA	95	NA		
		Hydrocarbons	< 0.1	< 0.1	< 0.1		

NB: NA=not available
Source: [378, Industrial NGOs 2012]

Table 8.55: Emissions to water from Plant V (silicon)

Water source	Waste water treatment	Pollutant	Unit (mg/l)			Method to obtain data	Monitoring frequency (number/year)
			Min.	Avg.	Max.		
Cooling water	Sedimentation tank	COD	10	19	27	Continuous composite sampling and measuring	4

Source: [378, Industrial NGOs 2012]

Table 8.56: Emissions to water from Plant J (HC FeMn)

Water source	Waste water treatment	Pollutant	Unit (mg/l)			Method to obtain data	Measurement frequency (number/year)
			Min.	Avg.	Max.		
Gas-cleaning water (Venturi scrubber)	Polymer addition, sedimentation. Bleed additives: iron sulphate and polymer, filtered through a sand filter and activated carbon filter	Pb	0.011	0.047	0.177	Continuous composite sampling	Monthly average
		Zn	0.002	0.648	8.56		Daily average
		Cu	0.293	3.056	5.21		Monthly average
		Cd	0.0012	0.0024	0.0053		
		As	0.028	0.056	0.08		
		Ni	0.582	0.94	1.41		
		Cr tot		0.025			
		Co	0.95	1.762	3.4		Daily average
Mn	0.001	0.00477	0.021				

Source: [378, Industrial NGOs 2012]

Table 8.57: Emissions to water from Plant Z (HC FeMn)

Water source	Waste water treatment	Pollutant	Unit (mg/l)			Method to obtain data	Measurement frequency (number/year)
			Min.	Avg.	Max.		
Rainwater		Pb	0	0.14	0.8	Single random sampling	52
		Zn	0.01	1.18	7.87		
		Mn	0.56	4.03	15.19		
		Other metals	1.8	8.24	19.5		12
		Fe	1.27	2.79	5.95		52
		Ntotal	5.32	11.92	16.22		12
		Ptotal	0.34	0.72	1.13		
		BOD ₅	0	3	8		
		COD	59	96	151		52
		Suspended solids	2	38.25	98		
PAH	0	0.08	0.4	12			

Source: [378, Industrial NGOs 2012]

Table 8.58: Emissions to water from Plant K (LC FeMn + MC FeMn + SiMn)

Water source	Waste water treatment	Pollutant	Unit (mg/l)			Method to obtain data	Measurement frequency (number/year)
			Min.	Avg.	Max.		
Gas-cleaning water (Venturi scrubber)	Polymer addition, sedimentation. Bleed additives: iron sulphate and polymer, filtered through a sand filter and activated carbon filter	Pb	0.0082	0.034	0.165	Continuous composite sampling	Monthly average
		Zn	0	0	0.0063		Daily average
		Cu	0.256	2.502	6.62		Monthly average
		Cd	0.001	0.0015	0.002		
		As	0.006	0.017	0.04		
		Ni	0.228	0.816	1.46		
		Cr tot		0.025			
		Co	0.642	1.346	2.12		Daily average
Mn	0.06	0.31	4.56				

Source: [378, Industrial NGOs 2012]

Table 8.59: Emissions to water from Plant M (FeMn + SiMn)

Water source	Waste water treatment	Pollutant	Unit (mg/l)			Method to obtain data	Measurement frequency (number/year)
			Min.	Avg.	Max.		
Surface run-off water	Physical sedimentation and chemical treatment	Pb	< 0.005	< 0.00519	< 0.011	Continuous composite sampling	Daily average
		Cd	< 0.02	< 0.02	< 0.02		
		As	< 0.004	< 0.005	< 0.005		
		Ni	< 0.01	< 0.02	0.06		
		Cr tot	< 0.01	< 0.05	< 0.05		
		Fe	< 0.05	0.14	0.27		
		Ntotal	< 5	< 5	< 5		
		BOD ₅	< 1	1.4	5		
		COD	< 5	11.36	17		
		Suspended solids	< 2	7.8	12		
		PAH	< 0.003	< 0.003	< 0.003		
		BTEX	< 0.001	< 0.003	< 0.0035		
		TPH	< 0.05	0.021	0.21		

Source: [378, Industrial NGOs 2012]

Table 8.60: Emissions to water from Plant O (LC SiMn + LC FeMn + MC FeMn)

Water source	Waste water treatment	Pollutant	Unit			Method to obtain data	Measurement frequency (number/year)
			Min.	Avg.	Max.		
Cooling water	Physical sedimentation. No chemical treatment	pH	7.9	8.2	8.4	Single random sampling	365
		Temperature difference (°C)	0	1.5	3		12
		Suspended solids	2	5.8	14		8
		Hydrocarbons	< 0.05	0.06	0.13		4

Source: [378, Industrial NGOs 2012]

Table 8.61: Emissions to water from Plant I (LC SiMn + HC SiMn)

Water source	Waste water treatment	Pollutant	Unit (mg/l)			Method to obtain data
			Min.	Avg.	Max.	
Gas-cleaning water (Venturi scrubber)	Flocculation, settling tank and sand and activated carbon filters	Pb	NA	0.095	NA	Continuous composite sampling
		Zn	0.01	0.02	0.13	
		Cu	NA	0.21	NA	
		Cd	NA	0.025	NA	
		As	NA	0.051	NA	
		Mn	0.1	0.15	1.3	
		Cr tot	NA	0.15	NA	
		Suspended solids	1	4.77	21	
		PAH	0.0009	0.014	0.29	
		Cyanides	NA	1.35	NA	

NB: NA = Not available.

Source: [378, Industrial NGOs 2012]

Table 8.62: Emissions to water from Plant Y (silico-manganese)

Water source	Pollutant	Unit (mg/l)			Method to obtain data	Measurement frequency (number/year)
		Min.	Avg.	Max.		
Cooling water	Pb	0.0025	0.025	0.23	Periodic composite sampling	Monthly average
	Zn	0.009	0.6	8.7		Weekly average
	Cu	0.001	1.8	22.2		
	Mn	0.022	1.72	23.3		
	Suspended solids	1.2	13.5	69.7		
	PAH (B6)	0.0001	0.02	0.17		

Source: [378, Industrial NGOs 2012]

Table 8.63: Emissions to water from Plant B (molybdenite roaster)

Water source	Waste water treatment	Pollutant	Unit (g/d)			Method to obtain data	Measurement frequency (number/year)
			Min.	Avg.	Max.		
Emission from sulphuric acid plant (cooling water bleed is reused as make-up water for wet gas cleaning plant)	H ₂ O ₂ is dosed for removal of SO ₂ . Solvent extraction is applied for removal/recovery of rhenium. Sodium hydrosulphide is dosed for removal of Mo, Re, Cu, Pb, As and Se. Filtration is applied for removal of dust	Pb	0.1	0.3	1.0	Continuous composite sampling	10
		Zn	0.3	53	380		1
		Cu	0.1	0.3	1.1		
		Sn	0.1	0.4	3.3		
		Bi	0.1	0.4	2.3		
		F as HF	1.1 kg/d	4.4 kg/d	10.8 kg/d		
		H ₂ SO ₄	0 kg/d	2318 kg/d	6022 kg/d		10

Source: [378, Industrial NGOs 2012]

Table 8.64: Emissions to water from Plant X (roasting and ferro-molybdenum)

Water source	Waste water treatment	Pollutant	Unit (mg/l)			Method to obtain data	Monitoring frequency (number/year)
			Min.	Avg.	Max.		
Process, cooling and rainwater production	Physico-chemical waste water treatment: flocculation (removal of Se) and chemical precipitation with FeCl ₃ (removal of Mo, As, etc.)	Pb	0.008	0.0081	0.0082	Periodic composite sampling	3
		Zn	0.035	0.067	0.088		
		Cu	0.016	0.021	0.028		
		As	0.017	0.017	0.017		12
		Mo tot	0.015	1.29	1.70		
		Se tot	0.0181	0.0181	0.0181		
		F ⁻	1.1	1.2	1.3		2
		SO ₄ ⁻	10	375	680		3

Source: [378, Industrial NGOs 2012]

Cross-media effects

- Increase in energy consumption.
- Increase in chemical consumption.

Technical considerations relevant to applicability

No information provided.

Economics

No information provided.

Driving force for implementation

No information provided.

Example plants

Plants in BE, ES, FI, FR, NL and NO.

Reference literature

No reference literature provided.

8.3.7 Process residues

The processes and recycling routes discussed earlier as applied methods in Sections 8.1 and 8.2 are all techniques to consider in the determination of BAT. The most important factors to reduce the environmental impact of residues are process-integrated measures that result in the generation of fewer residues. If the amount of process residues is minimised using primary measures, the remaining amount should be recycled or reused as much as possible. The specific feed materials will influence the final process choice. The techniques discussed in Section 2.9 should also be considered in conjunction with these processes.

8.3.7.1 Techniques to prevent and minimise residues and wastes from ferro-alloy production

Description

The techniques to consider are the recycling and reuse (when slag is considered a by-product and not waste) of generated slags and dust/sludge from air emissions abatement systems. More information on the recycling and reuse techniques is given in Section 8.2.5.

Technical description

See Section 8.2.5.

As an example of the solubility properties of ferro-chrome slag by the column test L/S 10 (mg/kg) compared to the criteria for the acceptance of waste at landfills for inert and non-hazardous wastes are provided in Table 8.65.

Table 8.65: Detailed features of ferro-chrome slag

Metal	Ferro-chrome slag products	Landfill requirements for inert wastes	Landfill requirements for common wastes
Total chrome	0.048–0.112	0.5	10
Arsenic	< 0.105	0.5	2
Cadmium	< 0.011	0.04	1
Mercury	< 0.01	0.01	0.2
Fluoride	4.22–6.30	10	150
Molybdenum	< 0.056	0.5	10
Nickel	< 0.105	0.4	10
Zinc	< 0.941	4	50

Achieved environmental benefits

Reduction of use of natural resources and reduction of waste for disposal.

Environmental performance and operational data

No information provided.

Cross-media effects

No information provided.

Technical considerations relevant to applicability

No information provided.

Economics

No information provided.

Driving force for implementation

No information provided.

Example plants

No information provided.

Reference literature

No reference literature provided.

8.3.8 Energy**8.3.8.1 Technique to recover heat from semi-closed furnaces****Description**

The technique to consider is the use of the exhaust gas energy to produce electrical power, heat energy or both.

Technical description

Within a semi-closed furnace, the CO gas from the smelting process is completely oxidised inside the furnace, thus creating a hot gas of about 400–800 °C, which can also reach peaks of up to 1200 °C. The furnace could be equipped with an integrated energy recovery system, which contains the following components:

- exhaust hood with furnace ducting;

- waste heat boiler;
- feed-water system;
- heat distribution system or steam turbine with generator and condenser.

The waste heat boiler recovers superheated steam from the energy in the hot gas generated by the furnace processes. Relatively conventional water tube boilers with a superheater, economiser and condenser sections are used, combined with an efficient cleaning system to keep the heating surfaces clean in the heavily dust-polluted flue-gas.

The furnace top hood is very exposed to the internal furnace heat and is conventionally cooled with a ceramic-lined water piping system. Some of the furnace heat emissions are lost to the top hood cooling water. For energy recovery, the top hood may be cooled by unshielded high-pressure water piping, producing steam in the waste heat boiler system. Such hoods exist and contribute substantially to energy recovery. The steam can be used in a condensing or a back-pressure turbine in order to produce electricity or can also be sold to another industry. The recovery system can be designed to produce hot water, which can be used by a local heating system (see Figure 8.22).

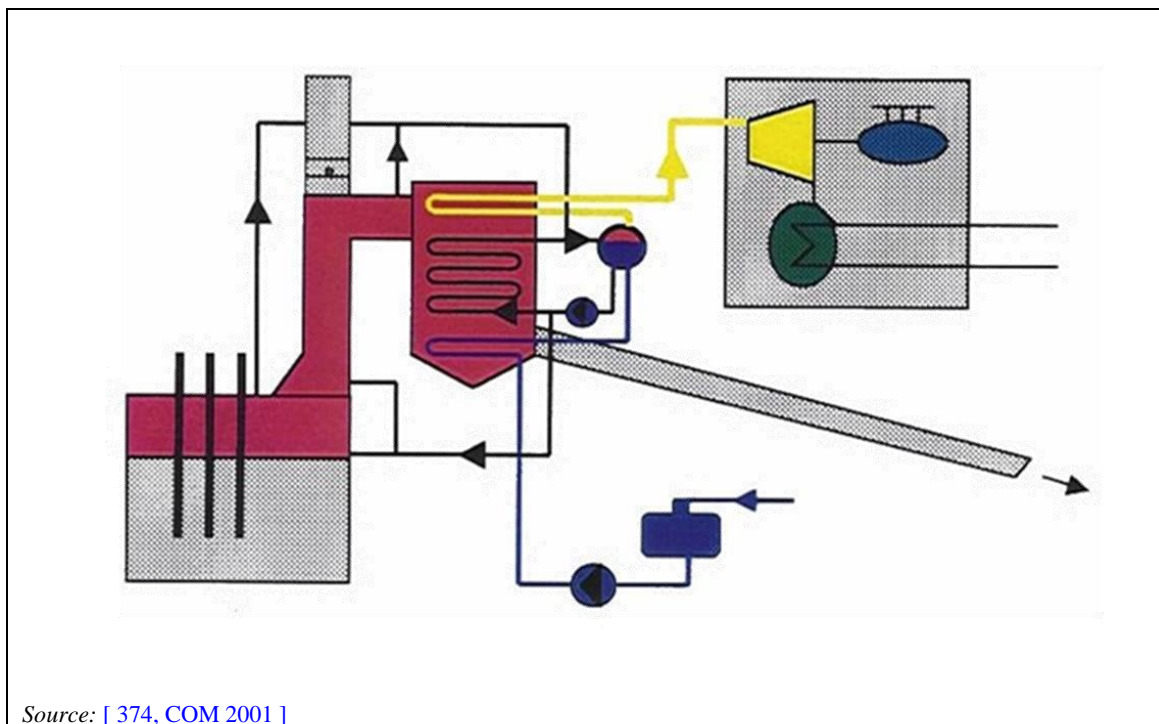

Figure 8.22: Energy recovery from a semi-closed furnace

Achieved environmental benefits

- Reduction of the overall energy consumption.
- Reduction of emissions to air (in most cases the recovered energy replaces fossil fuels like oil or coal).

Environmental performance and operational data

If the waste heat is utilised as electrical power, the recovery is up to 15–35 % of the electrical energy consumption. Alternatively, the steam can be drained at mean pressure and can be used for district heating and the recovery will then increase to approximately 80–90 %, but then only 20 % of the waste heat can be recovered as electrical power. The demand for district heating often varies throughout the year and the most efficient solution is the co-generation of electric power and heat energy to supply heat energy when needed.

Cross-media effects

Increased complexity of the furnace gas system.

Technical considerations relevant to applicability

The technology is generally applicable to both new and existing plants. Energy recovery is beneficial to existing plants when the energy can be produced in a manner that allows it to be used by the plant or its neighbours.

Economics

An energy recovery system means a high capital investment. Taking local conditions such as local energy prices, production periods and the absence of customers into account, the returns on investments may not be high enough to justify such investments.

The following results (see Table 8.66) should be seen as a cost indication because exact cost data are very much dependent on the specific circumstances of the plant.

The investment to recover electrical energy to produce electricity for a 70–100 MW installation is reported to be EUR 70–100 million.

Table 8.66: Examples of heat recovery from semi-closed furnaces

Technology	Waste heat medium	Heat recovered as	Temperature range of waste heat (°C)	Yield (%)	m EUR/MWh
	Waste gas/ cooling water/ hot oil	Hot water	50–200	75–95	0.4–2
Heat pump	Water/ exhaust air	Hot water (50–90 °C)	25–60	COP: 3–5	30–50
Shell boiler, water-based	Waste gas	Saturated steam 6–15 bar; 160–200 °C	200–600	30–65	25–50
Water tube boiler, water- based	Waste gas	Superheated steam 8–60 bar; 280–480 °C	400–1000	30–75	40–150
Boiler ORC/ turbine	Waste gas	Electricity	150–500	10–15	70–120
Water boiler/ turbine	Waste gas	Electricity	500–1000	20–35	300–400
Thermoelectric panel		Electricity	Heat radiation 800–1500	5–10	

COP: Coefficient of performance.
ORC: Organic Rankine cycle.
Source: [378, Industrial NGOs 2012]

Driving force for implementation

Reduction in energy consumption.

Example plants

Plants in Norway and Sweden.

Reference literature

[148, Kolbeinsen, L. et al. 1995] [149, Schei, A. et al. 1998], [154, Lindstad, T. et al. 1994], [183, ABB 1999], [184, Elkem 1999], [196, Finkeldei, L. 1999]

8.3.8.2 Energy recovery from closed electric arc furnaces

Description

The technique to consider is the use of the CO-rich exhaust gas generated in closed electric arc furnaces as a secondary fuel.

Technical description

If carbon is assumed to be fully converted into CO, i.e. the CO gas does not react, the carbon could theoretically be recovered as CO gas [255, VDI 2010]. In closed electric arc furnaces, this CO-rich gas (40–90 % CO) can be used as a fuel in other processes [407, Euroalliages 2013]

The exhaust gas is cleaned using a wet scrubber before it can be used as a secondary fuel. One possibility is combustion with air in a steam boiler. The steam is fed to a set of high-pressure and low-pressure turbines. The energy is then recovered as electricity (see Figure 8.23).

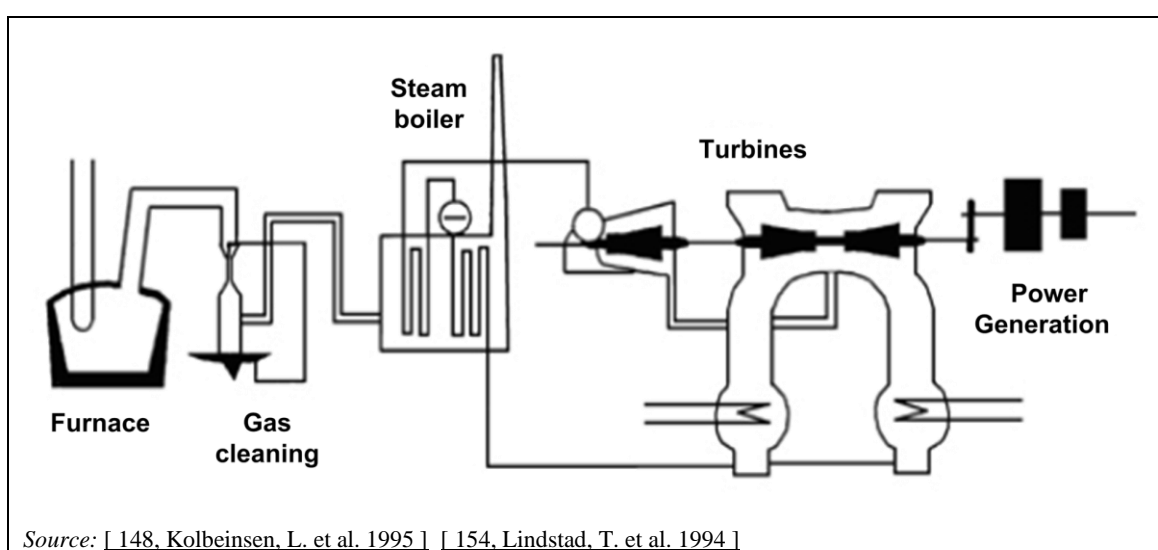

Figure 8.23: Direct use of the CO gas for the production of electrical energy

Besides the production of electricity, the CO gas can be used for the drying and heating of ladles and can also be transferred by pipeline around the plant area and used as a secondary fuel for many purposes. The best utilities are achieved in direct burning, replacing fossil fuels, e.g. heavy oil or coal. In the production of ferro-chrome, ferro-manganese and silico-manganese, CO gas can be used for the drying of coke and other raw materials. CO gas can also be used as a fuel in the steel belt sintering furnace, in order to reduce the primary energy consumption of the furnace. In the production of ferro-chrome, the CO gas is used to preheat the charge material, which reduces the consumption of electric energy by 70–90 kWh per 100 °C increase in the preheating temperature. The CO-rich gas can also be cleaned and then supplied as a synthetic gas to a neighbouring steel or chemical plant, in which the gas can serve as a raw material [138, Niemelä, P. 1999].

Achieved environmental benefits

- Reduction of the overall energy consumption.
- Reduction of emissions to air (in most cases the recovered energy replaces fossil fuels like oil or coal).

Environmental performance and operational data

- Steam produced: 35–40 tonnes/h.
- Energy recovery: 70 GWh/yr, which is equivalent to 13.5 % of the electrical energy input.

The reduction generates 650–750 Nm³ of CO gas per tonne of ferro-chrome with a reaction energy of 7550–8300 MJ (2100–2300 kWh) with good furnace sealing (Outokumpu). Of the electrical energy input, 66 % is recovered as energy.

Cross-media effects

No information provided.

Technical considerations relevant to applicability

This technique is applicable to new and existing plants producing ferro-chrome, ferro-manganese and silico-manganese in closed furnaces.

Economics

The cost is estimated to be about EUR 0.025 per kWh (7 % real interest rate and 15-year lifetime).

The different techniques to be considered for the recovery of energy are very dependent on local conditions, such as energy prices, periods of construction and the presence of potential customers.

Driving force for implementation

Reduction in energy consumption.

Example plants

Plants in Norway and Finland.

Reference literature

[148, Kolbeinsen, L. et al. 1995] [149, Schei, A. et al. 1998], [154, Lindstad, T. et al. 1994], [233, COM 2008], [255, VDI 2010], [371, Pekka et al. 2014]

8.3.8.3 Energy recovery from other furnaces

Description

The technique to consider is recovery of hot water.

Technical description

In ferro-vanadium production (in particular the production of nickel oxide and vanadium oxide in Austria), hot water can be recovered from the process to heat offices and workplaces, and can be used for hot water treatment and partially for protection against frost.

Achieved environmental benefits

- Reduction of overall energy consumption.
- Reduction of emissions to air (in most cases the recovered energy replaces fossil fuels like oil or coal).

Environmental performance and operational data

No information provided.

Cross-media effects

No information provided.

Technical considerations relevant to applicability

No information provided.

Economics

No information provided

Driving force for implementation

Reduction in energy consumption.

Example plant

A plant in Austria.

Reference literature

No reference literature provided.

8.4 Emerging techniques

The following techniques are emerging techniques, which means that these techniques are not fully implemented in the ferro-alloy industry:

- use of a rotary hearth furnace for pre-reducing chromite;
- smelt reduction processes using coal with oxygen or oxygen-enriched air to provide all the energy required for smelting chromite to ferro-chrome;
- closed furnace operation for the production of ferro-silicon and silicon metal (not yet successfully developed);
- use of a fluidised bed roaster for molybdenite roasting;
- recycling of slag from silicon production processes to reduce energy and raw material consumption in the production of silico-manganese; [244, France 2008]
- pretreatment of ores (drying, pre-reduction, etc.) in the manganese industry before feeding them to the furnace [407, Euroalliages 2013].

9 PROCESSES TO PRODUCE NICKEL AND COBALT

9.1 Applied processes and techniques

Nickel is produced from oxidic (laterite and saprolite) or sulphidic ore, about 60 % of the nickel comes from sulphide deposits and 40 % from oxide deposits. There are several variations in the processes used to produce nickel from these ores and these variations are dependent on the grade of the concentrate and also on the other metals that are present in the material [92, Laine et al. 1998].

Cobalt is usually present in nickel and copper ores and is recovered during their production. Refining of the recovered by-product that contains cobalt is performed by a combination of processes governed by the composition of the concentrate and the physical and chemical characteristics of the final product. Cobalt arsenide ores are also sources of cobalt. These ores are roasted to remove the majority of arsenic as arsenic oxide [104, Ullmann's Encyclopedia 1996]. However, the process is not used in the EU.

Table 9.1 shows the composition of some ores.

Table 9.1: Composition of some ores

Source of ore	Type	Ni (%)	Cu (%)	Co (%)
Murrin Murrin (Australia)	Laterite	1.07	NA	0.08
Cerro Matoso (Colombia)	Laterite	2.16	NA	NA
Selebi-Phikwe (Botswana)	Sulphide	0.77	NA	NA
Sudbury area (Canada)	Sulphide	1.18	1.73	NA
Raglan (Canada)	Sulphide	2.56	0.71	NA
Vale, Copper Cliff (Canada)	Sulphide	1.55	2	0.04
Cosmos (Australia)	Sulphide	5.7	0.2	0.1
Mount Keith (Australia)	Sulphide	0.6	0	NA
NB: NA=not available				

Secondary nickel and cobalt are consumed directly in the form of remelted scrap and other recycled products, generally in the production of ferro-nickel and stainless steel [92, Laine, L. 1998]. Other secondary materials such as catalysts and precipitator dusts are recovered in the primary smelting processes, usually in the slag furnace.

Because these metals are so closely associated, their production processes are dealt with together as far as possible [92, Laine, L. 1998].

9.1.1 Nickel production

9.1.1.1 Oxidic ores

In laterite ores, nickel and cobalt are bound with iron and manganese oxides or silica compounds and are difficult to upgrade to a concentrate. Smelting of these ores with a source of carbon in an electric furnace can be used. Ferro-nickel is produced or a nickel matte can be made after the addition of sulphur. The generic flowsheet is shown in Figure 9.1.

Prior to smelting, the ore is usually preheated or calcined in a rotary kiln. [106, Raffinot, P. 1993]. An electric furnace is then usually used for smelting.

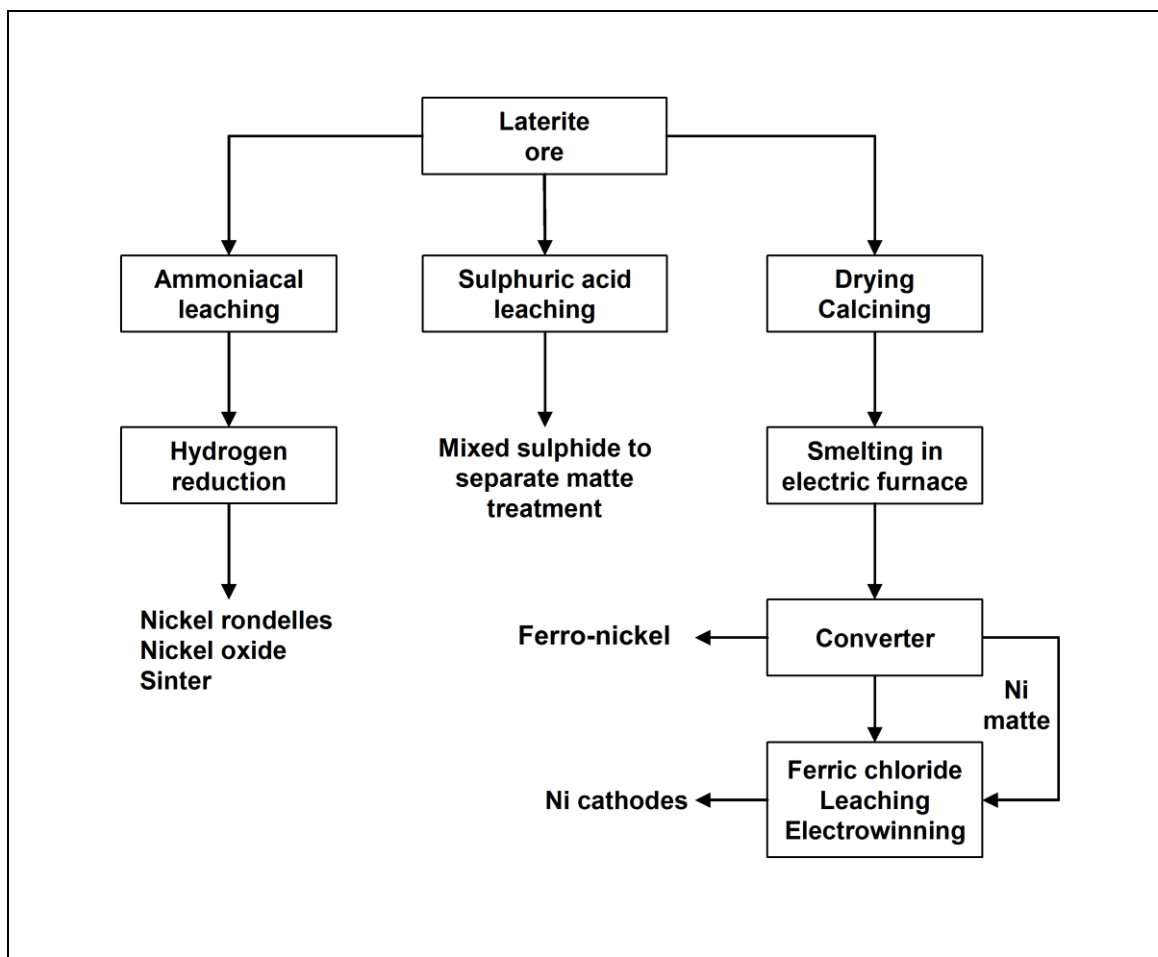

Figure 9.1: Generic flowsheet for nickel production from laterite ores

Saprolite ores can be smelted with sulphur so that the nickel oxide is converted to a nickel sulphide matte and iron is removed as a slag [106, Raffinot, P. 1993]. The matte is treated in the same manner as matte produced from sulphidic ores.

Smelting to ferro-nickel accounts for a large proportion of nickel production from laterite ores. These processes are discussed under ferro-alloys in Section 8.1.4. Leaching of laterite with ammonia is also used to extract nickel [19, HMIP (UK) 1994], [56, Knuutila, K. 1997], [94, Laine, L. 1998] and this process is becoming more widespread. Although conversion of nickel oxide to impure nickel and then to nickel carbonyl, which is volatile, is used to produce refined nickel, the nickel oxide is produced from the smelting of a sulphidic ore. The laterite ores generally have a maximum nickel content of 3% and are therefore not used directly in this process.

The pressure leaching of laterites with sulphuric acid is principally a simple and straightforward process. The temperature, pressure and other parameters may vary from case to case to achieve the best possible metallurgical conditions depending on the ore and products in question and other objectives. The temperature of the leaching autoclaves is usually between 230 °C and 260 °C and pressures of up to 43 bar are used. Oxygen can also be used in the process.

The resultant solution is purified either by modern solvent extraction methods or by traditional precipitation methods. For example, hydrogen sulphide is used to selectively precipitate nickel and cobalt sulphides, which are sent for further metal recovery. The solution can be neutralised so that iron precipitates. Nickel and cobalt will be precipitated and re-leached with ammonia.

Solvent extraction is used to separate nickel and cobalt chlorides or sulphates. Metallic nickel can be produced by electrowinning and cobalt can be precipitated as cobalt sulphide. Alternatively, nickel and cobalt can be recovered as metal powders using hydrogen reduction.

Table 9.2 shows the processes used in the EU-28.

Table 9.2: Processes used in the EU-28

Company name	Location	Industry sector	Process description
Eramet	Sandouville, France	Ni metal producer, Ni salts producer (Ni chloride, Ni hydroxycarbonate)	Nickel refining by a hydrometallurgical process, receiving imported nickel matte which is ground, dissolved with chlorine, purified and refined by electrowinning (NiCl ₂ salt and Ni metal production)
Xstrata Nickel	Kristiansand, Norway	Ni metal producer	Nickel refining by a hydrometallurgical process, receiving matte which is grained, dissolved with chlorine, purified and refined by electrowinning (Ni metal production)
Norilsk Nickel	Harjavalta, Finland	Ni metal producer, Ni salts producer (Ni sulphate, Ni hydroxycarbonate)	Nickel refining by electrowinning and hydrogen reduction
Boliden	Harjavalta, Finland	Nickel smelting	Sulphidic ore concentrates brought to the plant. Direct Outotec Nickel flash smelting (DON process). Production of Ni matte from sulphidic concentrates. Boliden also operates a copper flash smelter at the same site, producing copper anodes from sulphidic concentrates. The emissions of the nickel smelter and copper smelter are inseparable and thus emissions reported originate from both smelters. The dust emissions are monitored in three stacks: ventilation gases, Ni drying plant and Cu drying plant
Vale	Clydach, Swansea, UK	Ni metal producer, Ni sulphate producer (in China, not Clydach), Ni chloride producer (in China, not Clydach)	Imported nickel oxide. Refining of nickel using the carbonyl process

9.1.1.2 Sulphidic ores

Nickel-bearing sulphidic ores can be concentrated, e.g. by flotation, to upgrade the nickel content. Generally, nickel concentrates are produced containing 7–25 % nickel, which makes further processing easier. Sulphidic concentrates can also be dried in rotary dryers, steam-heated coil dryers or fluidised bed dryers. Feeding dry sulphidic concentrate to a primary smelting furnace, like a flash smelting furnace, enhances process performance and reduces the energy consumption and exhaust gas flow. Concentrates and sand used as flux are dried to reduce the moisture content from 7–8 % to about 0.2 % prior to the smelting process. The nickel concentrates are usually smelted under oxidising conditions to remove iron sulphide and other gangue materials from the concentrate to produce a nickel matte. The Outotec flash furnace is used in Europe; the Outotec and INCO flash furnaces and electric or shaft furnaces are used elsewhere in the world.

The nickel is recovered in a sulphide matte that contains 35–70 % nickel, cobalt and copper. The matte can be treated in a Peirce-Smith converter or alternatively it can be granulated or slowly cooled before a hydrometallurgical recovery stage [139, Riekkola-Vanhanen, M. 1999]. The converter stage is not used in Europe.

Important components of the nickel mattes are cobalt, copper and precious metals. The slag produced during smelting also contains recoverable metal and is treated in an electric furnace to produce more nickel matte. This can be granulated and treated separately [92, Laine et al. 1998], [94, Laine, L. 1998]. Secondary materials are sometimes recovered in the electric furnace. Figure 9.2 gives an overview of the process options.

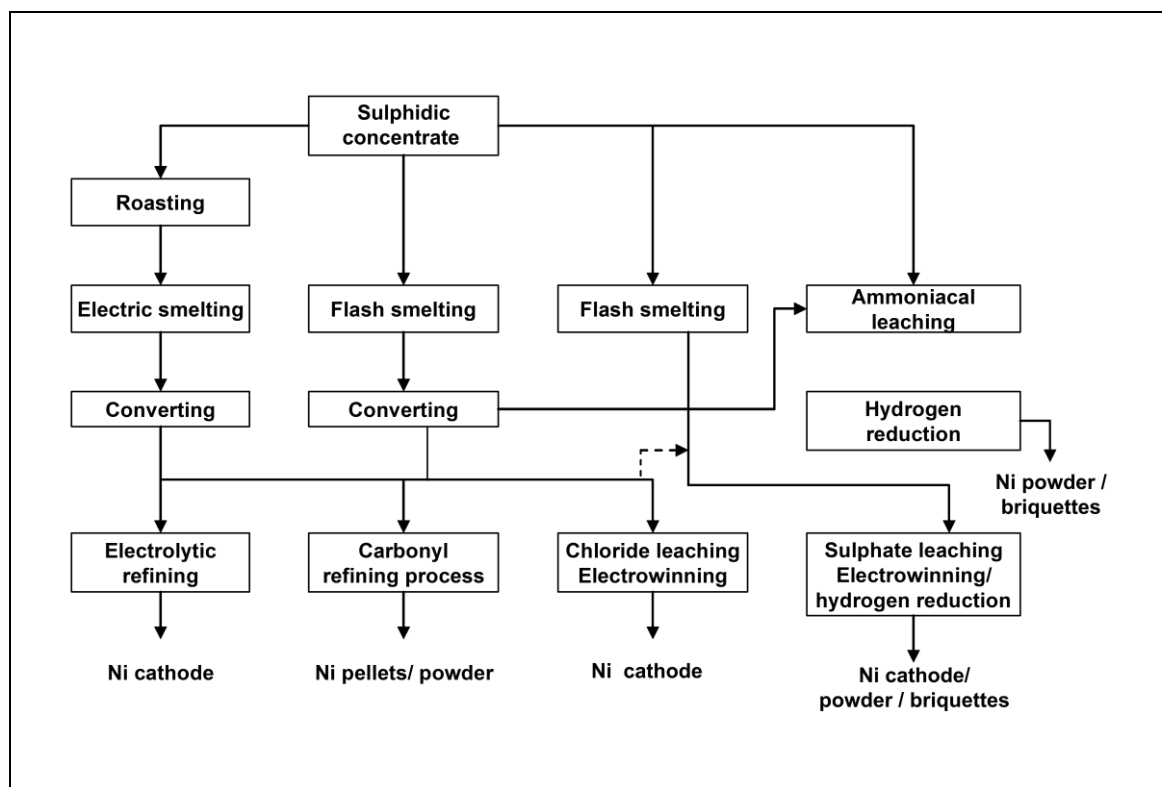

Figure 9.2: Generic flowsheet for the production of nickel from sulphidic concentrates

9.1.1.2.1 Conventional flash smelting process

Conventional smelting processes are used to remove iron and other gangue materials from sulphidic concentrates to produce nickel matte. Worldwide there are five smelters that use this process. Two of these use a flash smelting furnace designed by BHP Billiton (formerly Western Mining Corporation), where the smelting and slag cleaning furnaces have been built together to form one larger unit.

There are differences in operations between the smelters. The most visible is the matte grade but variations in the raw material composition also cause some differences. The generic flowsheet is shown below in Figure 9.3.

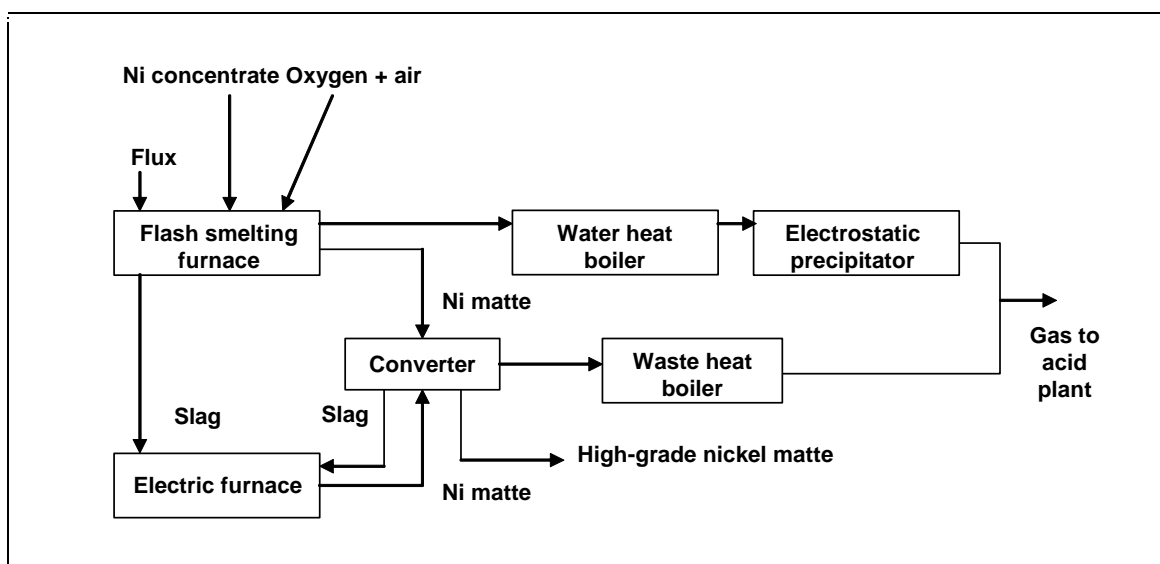

Figure 9.3: Conventional flash smelting process

9.1.1.2.2 Direct Outotec Nickel (DON) process

The DON process combines both smelting and converting to produce a high-grade matte which is further treated hydrometallurgically, [310, Makinen T., Taskinen P. 2006]

The flash smelting furnace is based on the utilisation of energy contained in the raw material itself to drive the smelting process. The dried concentrate and flux mixture is fed continuously with oxygen-enriched air through the concentrate burner into the vertical reaction shaft of a sealed furnace where the reaction between oxygen and concentrate particles takes place rapidly in suspension. Some of the sulphide compounds in the feed ignite, oxidise and release heat, thus acting as a fuel for the process. The operation uses oxygen enrichment to reach levels of about 30–90 % oxygen in the process air. The degree of oxygen enrichment is determined by the concentrate quality and the heat balance requirement. Oil burners are used to produce additional energy, when needed.

Molten phases are collected in the horizontal settler part of the flash smelting furnace where slag and matte form separate layers. The slag is laundered semi-continuously to the electric slag cleaning furnace where it is treated with coke and a sulphidising agent in order to recover the valuable metals left in the slag. The matte is periodically tapped and granulated by water quenching of the sprinkled melt. The solid matte granules settle in the bottom section of the tank, from where they are pumped with water to a dewatering screen. The granules are lifted in a bucket elevator into an intermediate bin and then taken on the belt conveyor for grinding and to the hydrometallurgical nickel plant.

The process is shown in Figure 9.4.

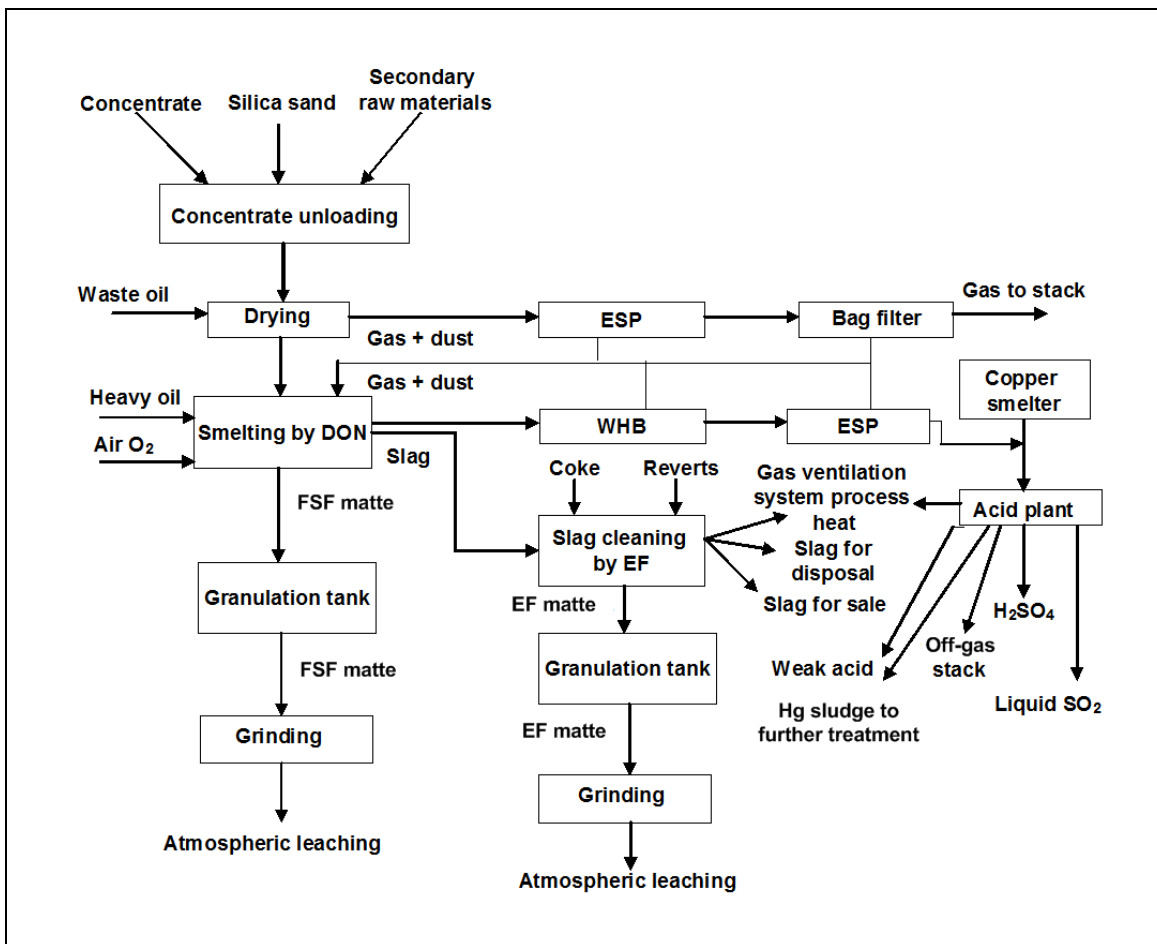

Figure 9.4: The DON process

9.1.1.3 Matte refining processes

The mattes produced by the smelting processes must be treated further in order to recover and refine the metal content. Nickel matte must go through a multistage refining process to reject iron and recover copper, cobalt and precious metals. Matte can be treated pyrometallurgically but hydrometallurgical processes are more commonly used. A variety of electrorefining, leaching, reduction and precipitation processes are carried out. Nickel is recovered from purified solutions by electrowinning or by hydrogen reduction.

Figure 9.5 shows the generic processing routes.

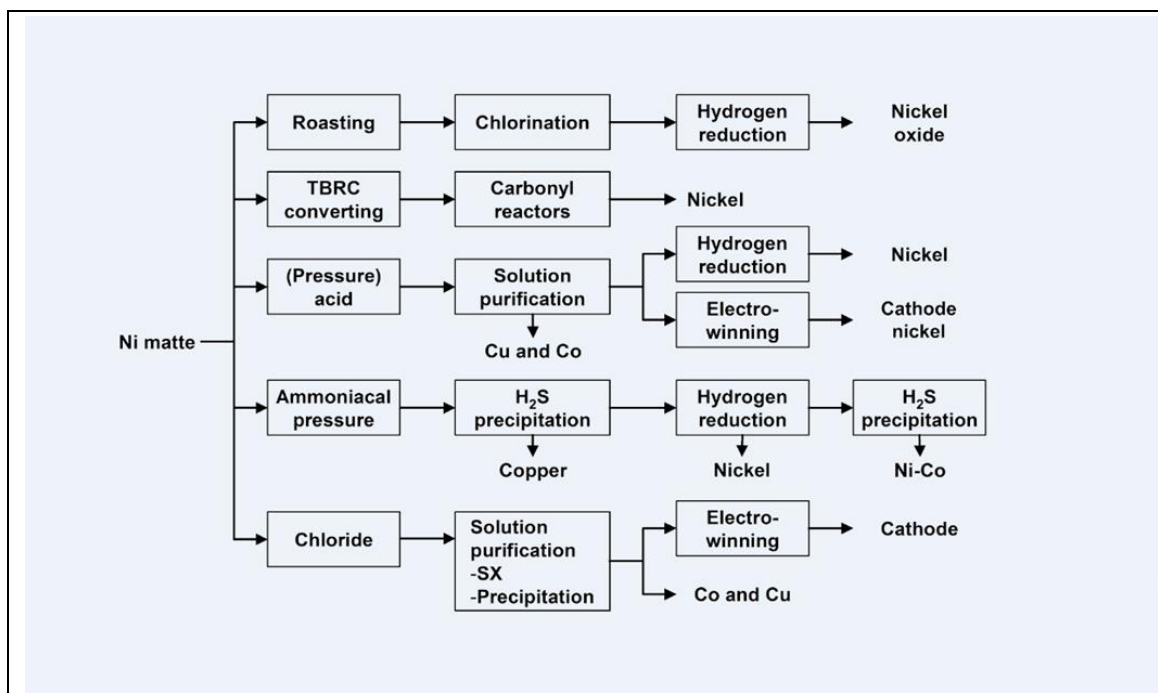

Figure 9.5: Generic flowsheet for nickel matte refining processes

Nickel-containing raw materials are leached in reactors (atmospheric; temperature < 110 °C and pressure 1 bar) and/or in pressure autoclaves (temperature > 100 °C and pressure > 1 bar). Leaching takes place in chloride- (see Section 9.1.1.3.1), sulphate- (see Section 9.1.1.3.2) or ammoniac- (see Section 9.1.1.3.3) based solutions and oxygen or chlorine gases are used as an oxidant. Impurities like copper and iron are precipitated as cake. In most cases copper cake is further processed and iron cake is recycled to the smelter or sent to the waste areas. Nickel solution is purified by a combination of solvent extraction and precipitation processes to remove cobalt and other impurities. Impurities like lead, manganese and gypsum are deposited in a designated waste area.

9.1.1.3.1 Chloride leaching of matte followed by electrowinning

Matte is leached in a chloride solution in several stages at a high temperature and pressure using chlorine gas as an oxidant. The chlorine gas is generated in the electrowinning cells and is returned to the leaching circuit. Copper is precipitated as sulphide and then iron and arsenic are precipitated as hydroxides and arsenates to purify the leachate. Copper sulphide is roasted in a fluidised bed furnace and the resulting calcine is leached with spent copper electrolyte. Copper is then electrowon.

Cobalt is removed by solvent extraction of the chloride solution using an organic solvent and is electrowon. The nickel solution is further purified using chlorine to remove lead and manganese, followed by electrowinning of nickel using a dimensionally stable anode (DSA) made with titanium, enclosed in a diaphragm bag to collect chlorine gas.

This is known as the Falconbridge process and is shown in Figure 9.6.

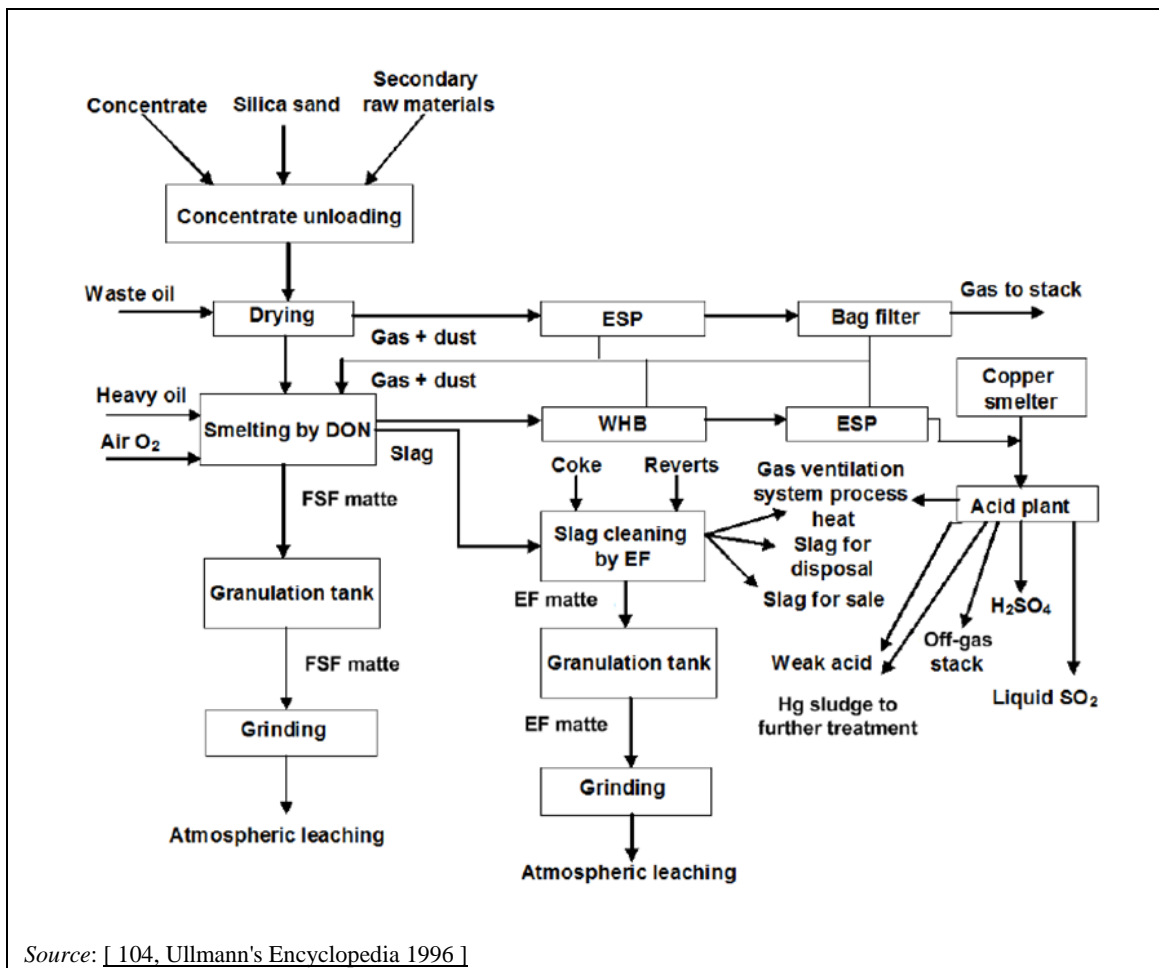

Figure 9.6: The Falconbridge process

9.1.1.3.2 Sulphate-based atmospheric pressure leaching followed by electrowinning/hydrogen reduction

Matte is leached in a sulphate-based anolyte recycled from nickel electrowinning. [57, Knuutila, K. et al. 1996], [58, Kojo, I.V. et al. 1997] Nickel sulphide matte is leached in an atmospheric leaching stage using oxygen- or air-sparged leach vessels with the aid of copper ions. Dissolved iron is oxidised to form iron oxide which precipitates (see Figure 9.7).

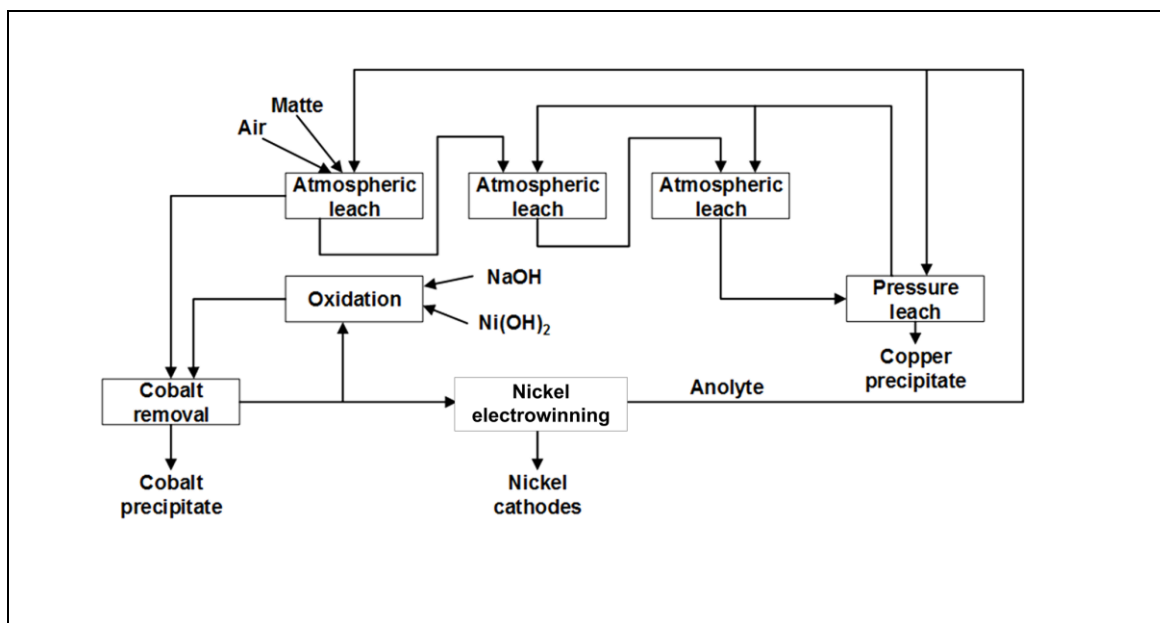

Figure 9.7: Sulphate-based leaching process

The residue from atmospheric leaching is passed to the pressure leaching stage where the nickel content is dissolved and copper is precipitated as copper sulphide, which is returned to the copper smelter. The iron oxide precipitate is returned to the nickel smelter. Alternatively, the iron residue is disposed of. The nickel solution from the atmospheric leach is purified by solvent extraction to remove cobalt and impurities. Cobalt can be electrowon or reduced to cobalt powder using hydrogen. Nickel can be electrowon from the purified sulphate solution to produce cathodes. [310, Makinen T., Taskinen P. 2006].

Nickel powder can be produced by adding ammonia and ammonium sulphate to the solution. The mixture is then reduced in an autoclave using a hydrogen atmosphere. The powder is sold or can be sintered into briquettes. The sulphuric acid present is neutralised by ammonia. The ammonium sulphate is recovered for sale or reuse in the process.

This process has been developed into a two-stream process to allow separate treatment of the mattes produced from the smelter and the slag cleaning furnaces. The flowsheet of the DON refining process is shown in Figure 9.8.

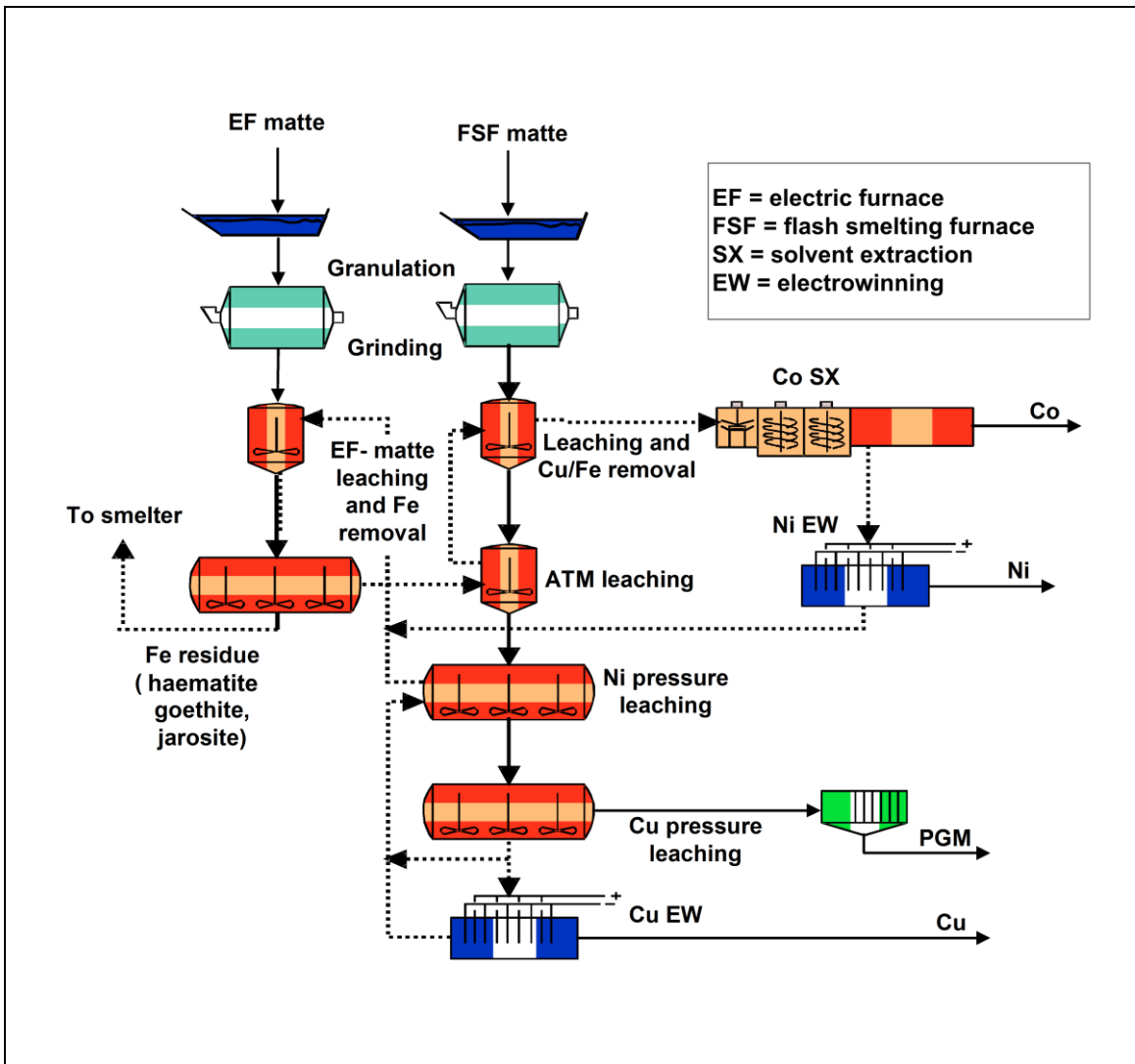

Figure 9.8: Flowsheet of the DON refining process

9.1.1.3.3 Ammonia pressure leach and hydrogen reduction

Matte is leached into ammoniacal ammonium sulphate solution in pressure autoclaves using air as an oxidant. After the precipitation of copper sulphide, nickel solution is reduced with hydrogen in the autoclaves to produce metallic nickel powder. The ammonium sulphate formed in the hydrogen reduction stage is recovered by crystallisation and drying. After the hydrogen reduction, the rest of the dissolved nickel and all the cobalt are precipitated with hydrogen sulphide for further treatment [92, Laine et al. 1998] [94, Laine, L. 1998]. This is known as the Sherritt process and is shown in Figure 9.9.

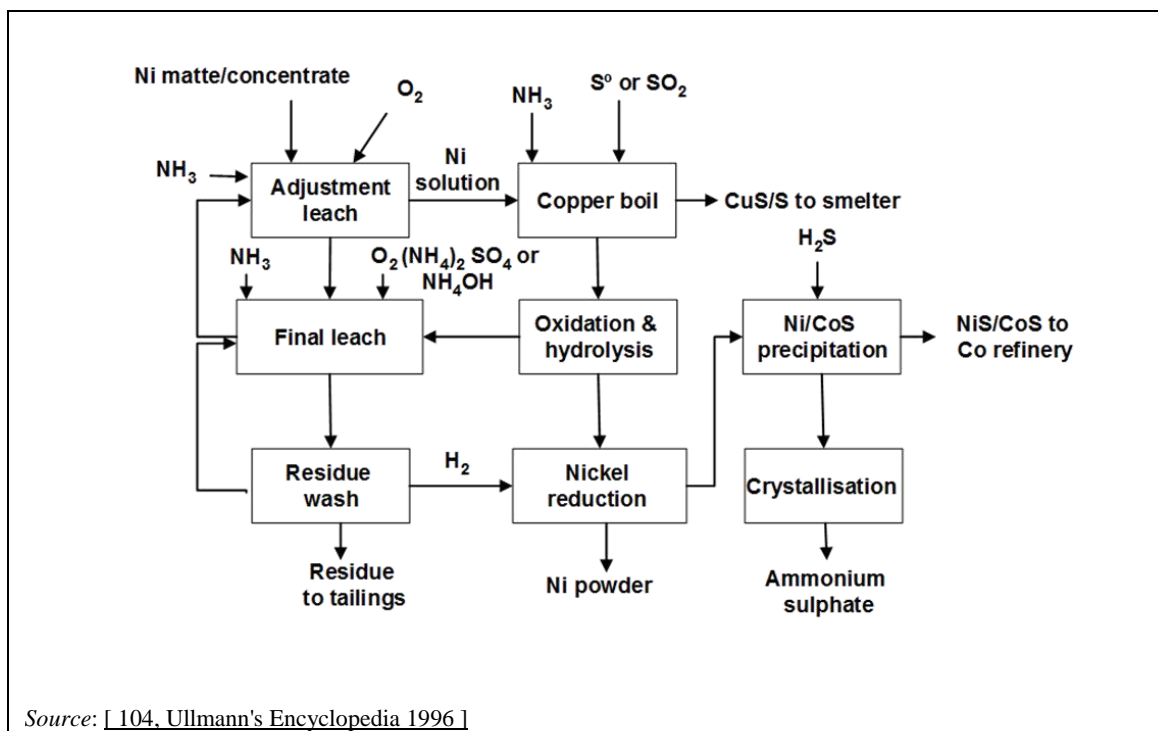

Figure 9.9: The Sherritt ammonia leach process

9.1.1.3.4 Ferric chloride leaching

Matte is leached in several stages using recycled ferric chloride in the presence of chlorine (which is generated from the electrowinning cells) near to boiling point. Sulphur remains in the elemental state and is filtered from the final solution. Iron is then removed by solvent extraction using tributyl phosphate, allowing ferric chloride to be recovered. Cobalt is removed in a further solvent extraction stage using triisooctylamine. Cobalt chloride solution is sold [92, Laine et al. 1998] [94, Laine, L. 1998].

Other minor impurities such as chromium, aluminium and lead are removed using a combination of electrolysis, ion exchange and activated carbon. Nickel is then electrowon from the purified solution in diaphragm cells using titanium anodes and nickel cathodes. Chlorine is collected and returned to the leach circuit.

9.1.1.3.5 Carbonyl process

The low-pressure carbonyl process uses an impure oxide produced by smelting sulphidic ore as the raw material to refine the nickel. This oxide is reduced to an impure metal using hydrogen and the metal is then activated. Nickel carbonyl is then formed by the reaction of the metal with carbon monoxide at a low temperature and pressure. Nickel carbonyl is volatile and is refined

by separation from the solid impurities. The solid residue is returned for further processing to the primary smelter to recover other metals that are present [19, HMIP (UK) 1994], [25, OSPARCOM 1996].

Nickel carbonyl gas passes out of the reactor and is then decomposed using heat to form powders and pellets. It can also be decomposed onto other substrates such as carbon fibres to produce nickel-coated materials. During decomposition, carbon monoxide is released and is recovered and reused to produce more nickel carbonyl. Pure nickel salts are produced by the reaction of nickel pellets with acids. Any exhaust gases from the process are incinerated to destroy any nickel carbonyl and carbon monoxide. Dust from the afterburner is removed using a bag filter.

9.1.1.3.6 Matte electrorefining

Nickel matte can be cast into anodes. These are dissolved in a diaphragm electrolytic cell using a chloride/sulphate electrolyte. The electrolyte from the anode compartment is purified and circulated through the cathode bag. The anodes are also bagged to collect the slime which contains sulphur. Elemental sulphur and precious metals are recovered from the slime. This process is limited to mattes that have a low copper content [94, Laine, L. 1998]

9.1.1.3.7 Solvent extraction

Most of the processes described above use a solvent extraction stage to remove iron, calcium and zinc and to separate nickel and cobalt prior to electrowinning or transformation. Metal ion complexes are formed using chelating agents so that the desired metal ions can be extracted into an organic phase. The desired ions are then back-extracted into a second aqueous phase by altering the conditions of that second aqueous phase.

The choice of solvent and chelating (complexing) agent allows specific metal ions to be removed from the aqueous solution and to be concentrated. The solvent/chelating mixture is recycled between the extraction and electrowinning baths. The baths comprise a mixer/settler to allow solvent-water contact and then phase separation. Sealed or covered systems are used to prevent the emission of solvent fumes. Figure 9.10 shows a generic process outline [239, ENIA 2008].

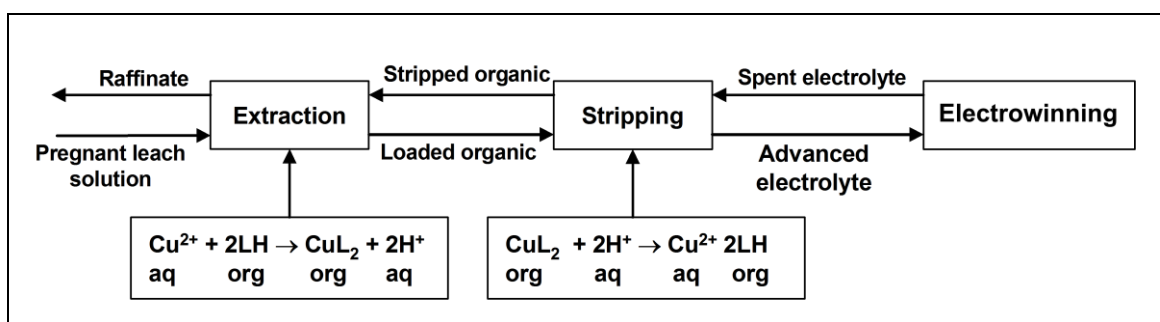

Figure 9.10: Solvent extraction (SX) process outline

9.1.1.3.8 Nickel matte refining process

Eramet has developed a refining process that originated in the 1970s which can (see Figure 9.11) [239, ENIA 2008].

- obtain very high-purity nickel metal;

- recover all of the by-products;
- minimise the solid residue production.

Pyrometallurgical nickel matte is leached by chlorine in a chloride medium in the presence of recycled ferric chloride near to boiling point. The major constituent of the leaching residue is elemental sulphur. This by-product, after roasting, allows the production of sulphuric acid.

The major constituents of the leaching solution are nickel, cobalt and iron chlorides. Impurities like aluminium, chromium, manganese and lead are also present.

After complementary oxidation of the solution, the iron is first extracted by solvent extraction using tributylphosphate (TBP) as an extractant. The stripping is performed with water. The iron chloride solution is sold, in concentrations of up to 40 wt-% FeCl_3 . It is used in water treatment processes.

The cobalt is extracted from the iron-depleted solution by solvent extraction using triisooctylamine as an extractant. The stripping is performed with water. The cobalt chloride is sold, after complementary purification, in concentrations of up to 27 wt-% CoCl_2 , as raw material for chemical specialities production.

Remaining minor impurities such as aluminium, chromium and lead are removed using a combination of precipitation, electrolysis and activated carbon in order to obtain a very pure nickel chloride solution that is used as a feed material to obtain various products including the following:

- Nickel chloride solution or crystals after concentration, crystallisation and drying.
- Nickel hydroxycarbonate by precipitation, filtration and spray drying.
- Nickel metal (purity > 99.99 %) by electrolysis in a chloride medium on titanium and nickel cathodes. Chlorine produced at the anodes is recycled at the matte leaching step.

The energy used for this nickel production process is in the range of 20 GJ per tonne of nickel which is in accordance with the energy use of the refining stages.

Emissions to air

The process has the following emissions to air:

- Ni: 0.025 kg/t Ni;
- Cl_2 : 0.010 kg/t Ni;
- VOCs: 3.6 kg/t Ni;
- SO_2 : 3.7 kg/t Ni;
- CO_2 : 600 kg/t Ni.

Emissions to water

The process has the following emissions to water:

- Ni: 0.017 kg/t Ni;
- Suspended solids: 0.18 kg/t Ni;
- COD: 2.0 kg/t Ni.

Residues and waste production

The Eramet nickel refinery using the process described here does not produce any solid residue for disposal.

The quantity of waste produced is 22 kg/t Ni. These data do not include wastes that are not linked to the production process itself.

A flowsheet of the Eramet refining process is shown in Figure 9.11.

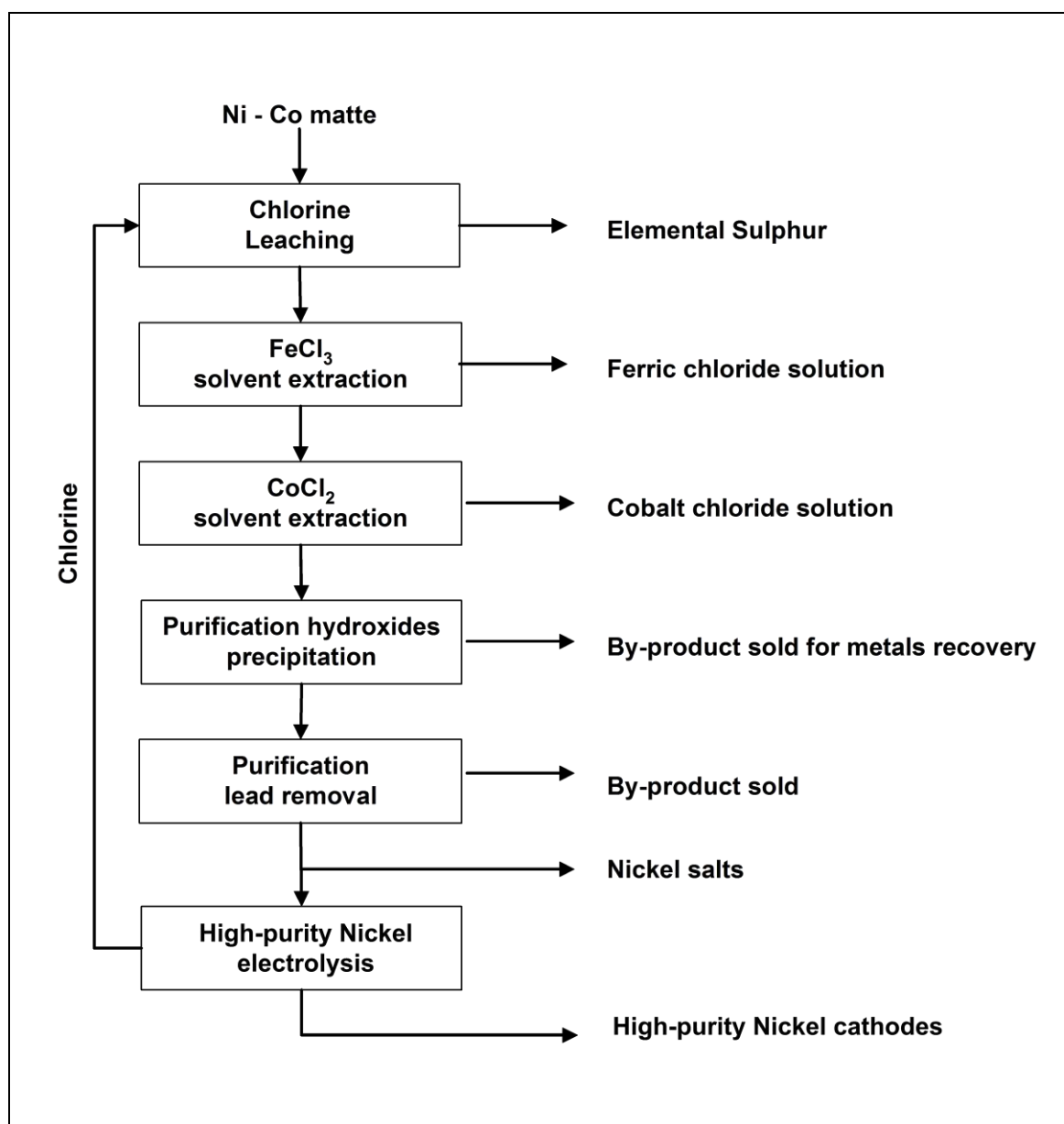

Figure 9.11: Flowsheet of the Eramet refining process

9.1.1.4 Nickel alloy production from secondary materials

The process includes raw material preparation, melting (including tapping and casting), ingot stripping and dressing, scrap recycling and 'electroslag refining' with a throughput of about 7000 t/yr.

Raw materials for the process consist of recycled scrap, purchased scrap and virgin material. Scrap in the form of turnings, swarf off-cuts, etc. is treated to remove oil by centrifuging and/or degreasing. Raw materials are weighed into charging vessels to the desired alloy composition. The charging vessels are then transported to the relevant furnace.

Melting is carried out in an induction furnace, with fumes captured by one of two extraction systems fitted with fabric filters. Some of the metal is further refined in vacuum refining furnaces. Vacuum induction melting is carried out in a 7.5-tonne-capacity furnace. Casting from

the furnace is performed either under vacuum or argon. Vacuum arc refining is carried out producing solid ingots under vacuum. The vacuum is provided by steam ejectors, and gases from the ejectors are cooled using spray condensers. Slag is refined in an electric furnace.

Three casting techniques are used: top casting, uphill casting and Durville casting. Casting fluxes and anti-piping compounds are used during casting. Ladles used for casting are preheated by gas-fired burners.

The ingots from casting are stripped of any residual refractory material. Solid waste from the casting processes, casting/ladle refractories, slags, etc. are collected for the recovery of residual metal. The stripped ingots may then be subjected to various processes: machining, sawing, grinding and shot blasting. The scrap from these processes in the form of dust, swarf and turnings is collected for reprocessing or sale.

9.1.2 Cobalt production

Cobalt is produced during the recovery of nickel after separation by solvent extraction (SX) and is described above in Section 9.1.1.3.7. Cobalt can be electrowon from the solution to produce saleable cathodes using diaphragm cells in the same manner as nickel [233, COM 2008]. The electrowinning process can be sulphate- or chloride-based.

Cobalt can also be recovered from the solution as a powder by hydrogen reduction. Alternatively, the solution can be treated to precipitate an impure cobalt by-product for further refining or for sale.

Further refining of these and other by-products that contain cobalt, intermediates and recycled materials is performed using atmospheric and oxygen pressure leaching in a sulphuric or hydrochloric acid medium. Separation using hydroxides, carbonates and amine or ammonium complexes is also used [104, Ullmann's Encyclopedia 1996].

Precipitation, solvent extraction and ion exchange techniques are used to purify the solutions. Cobalt is then recovered as metal powder, metal oxide or salts. The products are made with a wide variety of very specific physical and chemical characteristics. Pyrolysis of carboxylates, high-temperature reduction of oxides, precipitation and crystallisation techniques are used depending on the particle size or other characteristics that are required. [104, Ullmann's Encyclopedia 1996]

These processes are commercially confidential and very site-specific in nature. A generic flowsheet is shown in Figure 9.12 and a more specific process is shown in Figure 9.13.

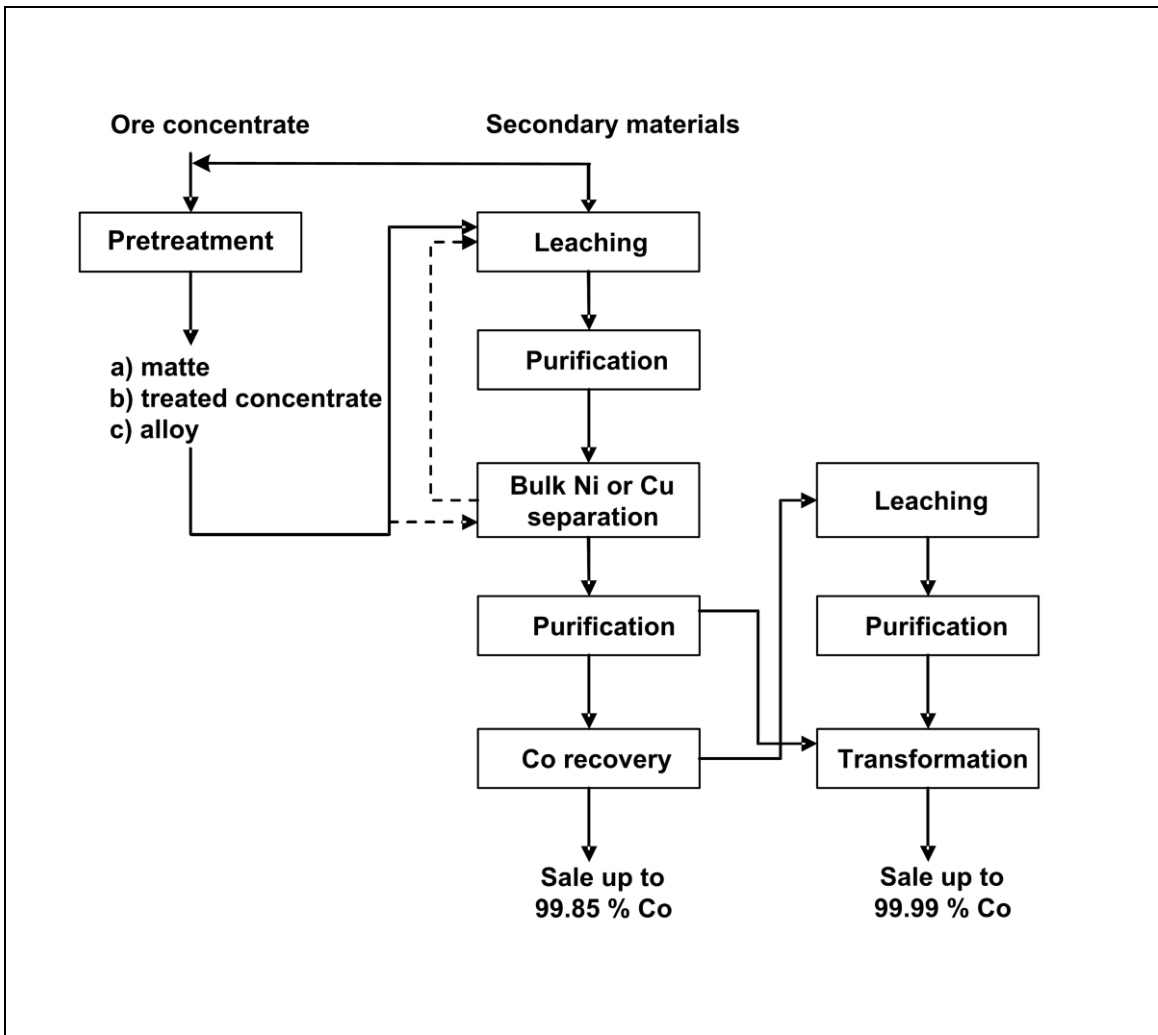
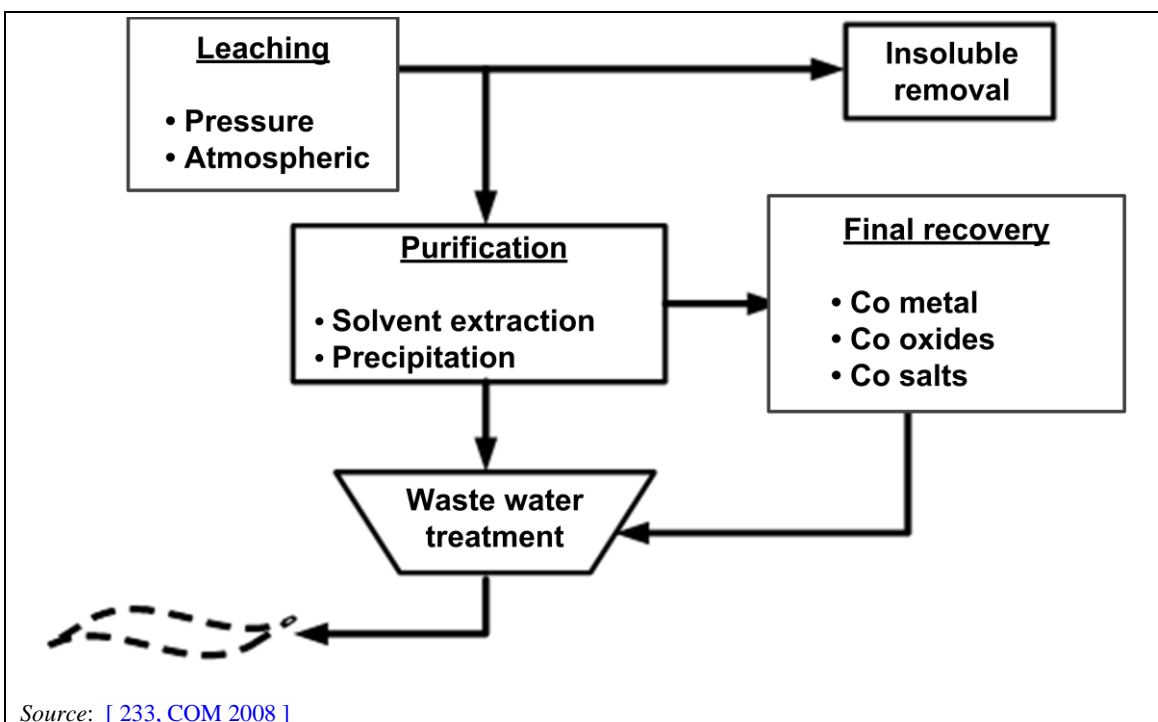

Figure 9.12: Generic flowsheet for cobalt production



Source: [233, COM 2008]

Figure 9.13: A practical cobalt flowsheet

9.2 Current emission and consumption levels

9.2.1 Energy consumption

The energy consumed for the production of matte from sulphidic concentrates is reported to be in the range 25–65 GJ per tonne of nickel for concentrates that contain 4–15 % nickel. The energy consumed in the various refining stages is reported to be 17–20 GJ per tonne of nickel.

9.2.2 Emissions to air

The potential emissions of concern to air from nickel and cobalt production are:

- sulphur dioxide (SO₂) and other acid gases;
- oxides of nitrogen (NO_x) and other nitrogen compounds;
- metals and their compounds including arsenic;
- dust;
- chlorine;
- VOCs and odours;
- CO and carbonyls (alarm levels are usually set at 80 parts per billion).

The significance of the substances potentially emitted from the major sources is given in Table 9.3 and is discussed later in this section.

Table 9.3: Significance of potential emissions to air from cobalt and nickel production

Component	Roasting or smelting	Leaching and purification	Electrolysis	Solvent extraction	Sulphuric acid plant	Final recovery and transformation
Sulphur dioxide and trioxide ⁽¹⁾ HCl	•• ⁽¹⁾	•	•	•	••	NR
VOCs (including CO and odours)	•	•	NR	••	NR	NR
Chlorine	NR	••	••	NR	NR	NR
Nitrogen oxides	• ⁽¹⁾	NR	NR	NR	•	NR
Dust and metals	•• ⁽¹⁾	•	•	NR	NR	••

⁽¹⁾ The direct emissions from the roasting or smelting stages of sulphidic ores are treated and/or converted in the gas-cleaning steps and sulphuric acid plant; the remaining emissions of sulphur dioxide and nitrogen oxides of the sulphuric acid plant are still relevant. Diffuse or uncaptured emissions are also relevant from these sources.
NB: •• More significant – • Less significant.
NR = Not relevant.

The sources of emissions from the process are:

- roasting;
- other pretreatment;
- smelting, converting and slag treatment;
- leaching and purification;
- solvent extraction;
- electrolysis;
- final recovery or transformation stage;
- sulphuric acid plant.

9.2.2.1 Sulphur dioxide and other acid gases

The major sources of sulphur dioxide emissions are diffuse emissions from the roaster or smelter. Uncaptured emissions from the ladle transfer and blowing stages of the converter and direct emissions from the sulphuric acid plant are also significant. Good extraction and sealing of the furnaces prevents diffuse emissions and the collected gases are passed to a gas-cleaning plant and then to the sulphuric acid plant.

After cleaning, the sulphur dioxide in the gas from the roasting stages is converted to sulphuric acid. Section 2.7.2 provide more information about the techniques and emissions from sulphuric acid plants in this sector.

During start-up and shutdown there may be occasions when weak gases are emitted without conversion. These events need to be identified for individual installations and many companies have made significant improvements to process control to prevent or reduce these emissions. Sulphur dioxide emissions from some processes are shown in Table 9.4.

Table 9.4: Sulphur dioxide production from some nickel and cobalt processes

Process	Product	Metal production (t/yr)	Sulphur dioxide (kg per tonne of metal produced)
Grinding/Leaching	Co and compounds	5000	0.01
Ni smelter	Ni, Co, Cu	200 000	18

NB: The data refer to specific raw materials, grinding of matte produced from sulphidic ore and smelting of Cu/Ni sulphidic concentrates.
 Source: [239, ENIA 2008]

During electrolysis, there are emissions of aerosols (diluted hydrochloric and sulphuric acids and metal salts) to the tank house. These emissions leave the tank house via the (natural) ventilation or from the cooling towers and are classed as diffuse emissions. Cells can be covered by foams or plastic beads to reduce the production of mists. Cell room ventilation air can be demisted and the solution returned to the electrolysis stage.

Chlorine is formed during the electrolysis of chloride solutions. This is collected in the sealed anode compartment and is returned to the leaching stage. Chlorine monitors are used to detect leaks and scrubbers are used to remove traces of chlorine from the ventilation air and other sources.

9.2.2.2 VOCs

VOCs can be emitted from the solvent extraction stages. A variety of solvents are used and they contain various complexing agents to form complexes with the desired metal that are soluble in

the organic layer. Emissions can be prevented or minimised by using covered or sealed reactors and, in this case, emissions in the order of 30 mg/Nm³ have been reported.

The solvents can be aliphatic or aromatic in nature but usually a mixture is used. VOCs can be classified according to their toxicity but aromatic and chlorinated VOCs are usually considered to be more harmful and require efficient removal. Solvent vapours are emitted depending on the temperature of the extraction stage and the vapour pressure of the solvent components at that temperature. VOC concentrations of up to 1000 mg/Nm³ (~ 1 kg/h) have been reported but the operating conditions are not known [92, Laine et al. 1998]. The nature of the solvents and conditions of use need to be determined so that the hazard can be assessed.

VOCs can be removed using condensers or by cooling the ventilation air and recovering the solvent for further use. Mass emissions of 0.2 kg per tonne of metal produced have been reported following condensation [92, Laine et al. 1998]. Carbon filters or biofilters can also be used to reduce VOC emissions further but do not allow solvent recovery.

9.2.2.3 Dust and metals

Dust carry-over from the roasting, smelting and converting processes are potential sources of direct and diffuse emissions of dust and metals. In some processes, the gases are collected and treated in scrubbers and fabric filters or in the gas-cleaning processes of a sulphuric acid plant. Dust is removed and returned to the leaching process. Fabric filters and scrubbers are used to remove dust and large particles. Dust and metal emissions from some processes are shown in Table 9.5 and Table 9.6 but it should be noted that different processes and process stages are involved and the data are not comparable [260, Nyberg et al. 2000].

Table 9.5: Dust and metal emissions from some European processes

Process	Product	Production (tonnes)	Dust (kg per tonne of metal)	Ni (kg per tonne of metal)
Matte grinding	Ni	12 000	0.02	0.005
Refining nickel matte	Ni		0.04	NA
Carbonyl process	Ni	40 000	0.01	0.005
DON process and copper smelter ⁽¹⁾	Ni, Cu	240 000	0.25	0.02

⁽¹⁾ The DON process and copper smelter comprises a site that includes drying, smelting (Cu+Ni), Cu converting, slag cleaning (Cu+Ni), all Ni matte refining processes and other abatement processes.
NA=not available.
Source: [239, ENIA 2008]

Table 9.6: Emissions to air from some process stages of cobalt production

Process	Product	Production (tonnes)	Co (kg per tonne of metal)	Ni (kg per tonne of metal)	VOCs (kg per tonne of metal)
Grinding/leaching	Co	10 000	0.1	NA	NA
Solvent extraction	Co	10 000	NA	NA	4.0
Final recovery or transformation	Co	10 000	0.8	0.1	NA
Total	Co	10 000	0.9	0.1	4.0

NB: NA = Not available.
Source: [239, ENIA 2008]

9.2.2.4 Chlorine

Chlorine is used in some leaching stages and is produced during the subsequent electrolysis of chloride solutions. The leach vessels are sealed and chlorine gas scrubbing is used to remove uncaptured chlorine.

The anodes in the electrolytic cells are contained in a membrane and enclosed by a collection hood. The chlorine generated is collected and reused in the leaching stage. The systems are sealed and diffuse emissions only occur during membrane or pipework failures. Chlorine alarms are used extensively in leach and cell rooms to detect such failures and there are normally no emissions of chlorine [233, COM 2008].

The presence of chlorine in waste water can lead to the formation of organic chlorine compounds if solvents, etc. are also present in a mixed waste water.

9.2.2.5 Hydrogen, carbon monoxide and carbonyls

Carbon monoxide and hydrogen are used in the vapometallurgical refining of nickel to produce crude nickel and then nickel carbonyl. These gases are explosive or very toxic and so sophisticated reactor seals and control equipment are used to prevent emissions. Comprehensive monitoring and alarm systems are used. Hydrogen is also used as a reducing agent in hydrometallurgical or pyrometallurgical recovery or transformation processes. Carbon monoxide is also produced in electric reduction furnaces if afterburning is not used. Robust process design including scaled equipment and appropriate gas exhaust systems is used to avoid explosive gas mixtures.

Carbon monoxide is recovered and waste process gases are finally incinerated to destroy any carbon monoxide or carbonyl that may be present. Nickel carbonyl is converted to nickel oxide, which is recovered.

9.2.2.6 Nitrogen oxides

The roasting and smelting stages are potential sources of nitrogen oxides (NO_x). NO_x may be formed from nitrogen components that are present in the concentrates or as thermal NO_x . The sulphuric acid produced can absorb a large part of the NO_x and this can therefore affect sulphuric acid quality. If high levels of NO_x are present after the roasting stages, treatment of the roasting gases may be necessary for product quality and environmental reasons. Direct smelting uses oxygen enrichment except for slag fuming and can reduce the thermal NO_x . Other furnaces that use oxy-fuel burners also show a reduction in NO_x but the reverse may be true at lower levels of oxygen enrichment when the temperature increase and the nitrogen content are significant. The range for all of the processes is 20–400 mg/Nm³.

9.2.2.7 Diffuse emissions

Besides process emissions, diffuse emissions occur. The major diffuse emission sources are:

- dust from storage and handling of concentrates;
- leakage from roasters, smelters and converters;
- dust from the exhaust gases of leaching and purification vessels;
- exhaust gases (including HCl, Cl₂ and VOCs) from the solvent extraction and electrowinning units;
- dust from the exhaust gases of casting furnaces;
- miscellaneous emissions including building ventilation air.

Although diffuse emissions are difficult to measure and estimate, there are some methods that have been used successfully (see Section 2.3.5). Table 9.7 gives some estimates from a primary smelter where the smelter and converter ventilation gases are collected and treated with the dryer gases.

Table 9.7: Significance of secondary fume capture and diffuse emissions

Emissions	Primary capture (t/yr)	Secondary capture (t/yr)	Diffuse (t/yr)
Sulphur dioxide (1999)	523	2242	147
Sulphur dioxide (2004)	630	1976	248
<i>Source: [239, ENIA 2008]</i>			

Table 9.7 shows that diffuse emissions can be significant in primary smelting if ventilation gases are not collected and treated. In this case they would be much higher than abated emissions. Refining processes are reported to have lower diffuse emissions and the carbonyl process is particularly well sealed. Action to reduce diffuse emissions may be needed in many processes.

It is possible to reduce the diffuse emissions arising from granulation fumes by treating the fumes with NaOH solution. Another way to reduce them is to use covered, ventilated lids on the launders. These launders can be heated using fuel or preferably electrically heated covers, which then allow an efficient collection of diffuse emissions thanks to the small amount of gas released.

Diffuse emissions from molten material transportation are also significant. In the DON process, as well as in flash smelting and flash converting processes, there is no ladle transportation of molten material and thus diffuse emissions are much easier to control.

The collection of diffuse emissions is described in Section 2.12.4.

9.2.3 Emissions to water

Metals and their compounds and materials in suspension are the main pollutants emitted to water. The metals concerned are copper, nickel, cobalt, arsenic and chromium. Other significant substances are fluorides, chlorides and sulphates.

Possible sources of waste water are:

- hydrometallurgical purification processes;
- matte granulation;
- waste water from wet scrubbers;
- waste water from wet electrostatic precipitators;
- waste water from slag granulation;
- anode and cathode washing liquid effluent;
- sealing water from pumps;
- general operations, including the cleaning of equipment, floors, etc.;
- discharge from cooling water circuits;
- rainwater run-off from surfaces (in particular storage areas) and roofs;

Waste waters from wet gas cleaning (if used) of the smelter, converter and fluidised bed roasting stages are the most important sources. Others are cleaning and miscellaneous sources. The leaching stages are usually operated on a closed circuit and drainage systems are isolated but there are potential problems unless good leak prevention and detection systems are used. Electrolyte bleed liquors are used in the leaching stage.

9.2.3.1 Waste waters from abatement plants

If wet scrubbers are used after the leaching and roasting processes, an acidic solution is produced. The scrubber removes fluorides, chlorine, chlorides, most mercury and selenium and some particles that pass the mechanical gas treatment. To avoid the build-up of contaminants, some liquid should be bled continuously from the scrubber and then treated. Dissolved SO₂ is removed prior to the discharge. Weak acid can also be treated by concentrating it and feeding it back into the uptake shaft of a flash smelting furnace.

Wet ESPs also generate an acidic scrubbing liquid. This is recycled after filtering or, after concentrating, it is returned to the uptake shaft of the flash furnace. Some liquid should be bled from this circuit to remove the build-up of contaminants. This bleed liquid is treated and analysed before discharge.

Table 9.8 provides an indication of the composition of the gas-cleaning effluents before treatment.

Table 9.8: Typical composition of gas-cleaning effluents

Pollutant	Concentration (dissolved)	Percentage of suspended solids
Solids		250–1500 mg/l
Sulphate	13–25 g/l	
Chlorides	1.3–1.8 g/l	
Fluorides	0.3–0.5 g/l	
Cobalt	0.1–9 mg/l	5–30
Nickel	0.1–10 mg/l	10–60
Copper	5–15 mg/l	< 0.05
Zinc	0.1–2.5g/l	2–6
Cadmium	1–5 mg/l	
Lead	1–3 mg/l	5–50

9.2.3.2 Miscellaneous sources

The electrodes and membrane bags used during electrolysis need to be rinsed periodically to remove material deposited on the surface. Manganese dioxide can be formed on the surface of the anodes by the reaction of oxygen with dissolved manganese. After rinsing the anodes, the manganese is separated from the rinse water for external reuse. Cathodes are cleaned after removal of the cobalt or nickel sheets. The anode and cathode washing liquid effluents are acidic and likely to contain copper, nickel, cobalt and suspended solids.

Granulation water from the granulation of matte or slag is usually recirculated in a closed circuit system. There have been reports of the formation of persistent organic chlorine compounds and PCDD/F in some cooling circuits of chlorine leach processes.

Filters and waste water from the hydrometallurgical separation and transformation processes are treated to remove metals and suspended solids. The products of this treatment may be returned to upstream operations, depending on their composition and value. The wet ESP can be used for that purpose. Potential sources of waste waters are reported in Table 9.9.

Table 9.9: Summary of potential waste water sources and treatment options

Process unit	Operation/source	Use/treatment options
General	Rainwater from roads, yards, roofs Wet cleaning of roads Cleaning of lorries, etc.	Waste water treatment plant/reuse Waste water treatment plant Recirculation, waste water treatment plant
Smelting operation	Cooling water from the furnace, machinery and equipment	Recirculation
Matte or slag granulation	Wet ESP effluent (if needed) Granulation water	Recirculation, waste water treatment plant Recirculation
Gas cleaning system	Condensate from gas cooling, wet ESP Condensate from mercury removal Leakage	Removal of suspended dusts and reuse as feed, or to waste water treatment plant After mercury removal to waste water treatment plant Recirculation
Sulphuric acid plant	Cooling water equipment Leakage	Recirculation Waste water treatment plant
Feed storage	Surface water (rain/wetting)	Waste water treatment plant
Sinter plant	Scrubber (sinter fine cooling)	Waste water treatment plant
Roaster gas cleaning	Wet gas cleaning	Waste water treatment plant
Leaching	General operations including wet gas cleaning	Recovery of metals
Purification	General operations Filter cakes	Recovery of metals Countercurrent washing
Electrolysis	Cleaning of cells, anodes and cathodes	Recovery of metals
All process units	Maintenance	Waste water treatment plant
Waste water treatment plant	Effluent treatment	Reuse for certain applications/discharge

Table 9.10 and Table 9.11 give data for emissions to water and the mass emissions of nickel per tonne produced for some European sites [239, ENIA 2008].

Table 9.10: Examples of waste water analyses

Process	Effluent (m ³ /d)	Flow (m ³ /t)	Main components (mg/l)					
			Cu	Zn	As	Co	Ni	COD
Co	NA	200	< 0.1	< 1.5	< 0.1	< 1.5 (¹)	< 1.0	25
Cl leach	NA	55	0.1	NA	NA	0.2	0.7	NA
Cl leach	NA	NA	1.0	1.0	NA	0.25	1.0	NA
Carbonyl	NA	450	0.4	NA	NA	0.1	1.4	NA
Smelter + leach (²)	10 900	NA	10 g/t	4 g/t	2 g/t	NA	10 g/t	NA

(¹) The Co emission is 0.5 kg per tonne of Co produced.
(²) The data of Smelter + leach covers process waters, cooling water, acid plant water and rainwater from a combined Cu and Ni smelter and nickel leaching.
NB: NA = Not available.
Source: [239, ENIA 2008]

Table 9.11: Mass emissions of nickel per tonne produced for European processes

Process	Waste water volume (m ³ /d)	Emission of nickel (g Ni per tonne produced)
Matte grinding and leaching	1640	15.7
Matte grinding and leaching	3233	16
Nickel smelting and matte refining ⁽¹⁾	1900	29.6
Carbonyl process	6615	30
⁽¹⁾ The data of nickel smelting and matte refining covers both the Cu and Ni smelter and the nickel leaching process. Source: [239, ENIA 2008]		

9.2.4 Process residues

The production of metals is related to the generation of several by-products, residues and wastes, which are also listed in the European Waste Catalogue (Council Decision 94/3/EEC). The most important process-specific residues are listed in this section.

Residues arise as a result of the treatment of liquid effluents. The main residues are gypsum (CaSO₄) waste and metal hydroxides that are produced at the waste water neutralisation plant. These wastes are considered to be a cross-media effect of these treatment techniques but many are recycled to the metallurgical process to recover the metals, depending on their value.

Dust and/or sludge from the treatment of gases are used as raw materials for the production of other metals such as precious metals and copper, etc. or can be returned to the smelter or to the leach circuit for recovery.

9.2.4.1 Precipitates from purification processes

The production of iron-based solids accounts for a significant volume of waste depending on the process used. An example of the compositions of different types of residues is shown in Table 9.12.

Table 9.12: Example compositions of different types of residues

Process	Fe (%)	Zn (%)	Co (%)	Cu (%)	Ni (%)
Iron hydroxide residues in the chloride leaching process	40	NA	0.1	< 0.1	1–2
Gypsum residues	NA	25	2–3	NA	NA
Waste water treatment plant	< 10	< 10	< 0.5	< 1	< 0.05
NB: NA=Not available.					

The disposal of these residues can entail considerable costs as specially constructed, lined ponds are used to contain the material. Particular care is taken with regards to leakage and operators of these ponds have to monitor groundwater. This is a significant cross-media effect. One site deposits the waste in underground rock caverns.

9.2.4.2 Pyrometallurgical slags and residues

Slags from smelting processes usually contain very low concentrations of leachable metals after slag cleaning. They are therefore suitable for use in construction, abrasives and other purposes. The slag output is between four and ten times the weight of the metal produced depending on the source of the concentrate.

Table 9.13 gives examples of the composition of some nickel slags. The exact composition will also depend on the source of the concentrate [139, Riekkola-Vanhanen, M. 1999].

Table 9.13: Example compositions of typical nickel slags

Component	Reverberatory furnace	Electric furnace	Outotec flash ⁽¹⁾
Nickel (%)	0.2	0.17	0.1–0.3
Cobalt (%)	0.1	0.06	0.1–0.25
Copper (%)	0.08	0.01	0.05–0.25
Iron (%)	38	NA	35–43
Silica (%)	36	35	30–39
Lime (%)	2	NA	0.5–7
⁽¹⁾ After cleaning in an electric furnace. NA=not available.			

A number of standard leachability tests are used by Member States and these are specific to the country in question. Nickel slags are listed in the EU on the amber list of the Transfrontier Shipment of Waste Regulations. The dross and solids, removed during the melting and refining stages, contain metals that are suitable for recovery. Table 9.14 shows some of the treatment or reuse options for solid residues from nickel and cobalt production processes.

Table 9.14: Some treatment or reuse options for solid residues from nickel and cobalt production processes

Process step	Solid output	Use/treatment options
Autoclave	Residue	Smelting furnace
Iron removal	Precipitate	Smelting furnace or disposal
Abatement	Filter dust	Smelting furnace
Pressure leaching	Sulphide residue	Cu recovery
Decoppering	Cu cement	Cu smelter
Nickel and cobalt regeneration	Impure nickel carbonate	Pure nickel sulphate production
Slag treatment	Clean slag	Construction
Removal of As, etc.	Gypsum ferric arsenate	Special disposal or As recovery
Effluent treatment	Precipitate	Recovery of other metals or disposal

9.2.4.3 Other materials

Depending on their composition and value, other residues or sludges arising from the different process stages or from general waste water treatment may be recycled or sent for final disposal.

9.3 Techniques to consider in the determination of BAT

The sections of this document entitled 'Techniques to consider in the determination of BAT' set out techniques generally considered to have the potential for achieving a high level of environmental protection in the industries within the scope of the document. The background to the way the techniques are described is given in Section 2.12 and Table 2.10.

This section presents a number of techniques for the prevention or reduction of emissions and residues as well as techniques for reducing the overall energy consumption. They are all commercially available. Examples are given in order to demonstrate techniques which illustrate a good environmental performance. The techniques that are given as examples are based on information provided by the industry, European Member States and the evaluation of the European IPPC Bureau. The general techniques described in Chapter 2 on common processes apply to a great extent to the processes in this sector and influence the manner in which the main and associated processes are controlled and operated. Techniques used by other sectors are also applicable particularly those relating to the use of sulphur recovery systems.

9.3.1 Nickel production

9.3.1.1 Material reception, storage and handling processes

9.3.1.1.1 Techniques to prevent and reduce emissions from the reception, storage and handling of materials

General techniques applied to reduce diffuse emissions from the reception, storage and handling of raw materials for nickel production are considered in Chapter 2 (see Section 2.12.4.1) and in the Emissions from Storage BREF [[290, COM 2006](#)].

Description

The techniques to consider are:

- collection and safe storage of hazardous material;
- extraction gas systems followed a by bag filter (see Section 2.12.5.1.4).

Technical description

Raw materials are concentrates, chlorine, other gases, intermediate products, fluxes and fuel, and other important materials are products, sulphuric acid, slags and process residues.

A list of issues and their management related to the technical processes are given below.

- Intermediate products such as matte which have the potential to form dust need to be handled using appropriate ventilation and dust capture systems, usually in an isolated and dedicated building.
- Chlorine, oxygen and other gases should be handled according to specific safety requirements to prevent leaks and contain the gases.
- Process gases such as oxygen and chlorine are collected and stored in approved pressure vessels. These gases are usually regenerated and recycled, i.e. directly returned to the process or stored for later reuse.
- Acid produced during the process should be stored in double-walled tanks and/or tanks placed in chemical-resistant retention bunds. The acid slimes from the sulphuric acid plant and weak acid from scrubbing systems are treated or processed locally and can be disposed of as secondary raw materials for other applications.

Achieved environmental benefits

- Reduction of dust emissions.

- Reuse of dust in the process, where possible.
- Prevention of material leakage.

Environmental performance and operational data

Operational and performance data are summarised in Table 9.15.

Table 9.15: Dust emissions from loading and on-site transport in a nickel plant

Plant	Techniques	Origin of the emission	Dust (mg/Nm ³)			Monitoring frequency
			Min.	Avg.	Max.	
Plant E	Bag filter	Loading and on-site transport of Ni matte	0.1	2.1	15.6	Continuous measurement (daily averages)
<i>Source:</i> [378, Industrial NGOs 2012]						

Cross-media effects

Increase in energy use.

Technical considerations relevant to applicability

Generally applicable.

Economics

No information provided.

Driving force for implementation

- Recovery of raw materials.
- Environmental and health regulation requirements.

Example plants

Plant D (UK) and Plant E (NO).

Reference literature

[291, COM 2001]

9.3.1.2 Material pretreatment processes

9.3.1.2.1 Techniques to prevent and reduce emissions from ore preparation and beneficiation

Description

The techniques to consider are:

- bag filter (see Section 2.12.5.1.4) and water spraying;
- sedimentation and flotation (thickener);
- drainage system.

Technical description

Preparation and beneficiation can use processes performed on dry or wet ore. Reducing emissions focuses on dust suppression, spillage handling and water recovery with a view to reducing the amount of residues and recycling water back to the processing plant.

Dust suppression can be managed by the use of dust extractors using fabric filters or abatement using water spraying systems.

Water recovery is carried out using thickeners. Specific tests are required to evaluate which design is best suited to the material's characteristics. The principle is to use gravity to let the particles settle freely. Flocculants and/or coagulants can be used to improve water recovery.

Dry residues, or those with limited water content, can be easily managed at the on-site residue storage area.

To control the effects of potential spills, the plant should be built with a drainage system so that surface run-off water is collected in a sump.

Achieved environmental benefits

- Prevention and reduction of dust and metals emissions.
- Preservation of raw materials, as filter dust is reused in the process.
- Reduction of water use.

Environmental performance and operational data

The use of a thickener is usually associated with the use of flocculants and/or coagulants. Flocculants are usually organic polymers while coagulants are either organic or mineral. The dosage is usually between 5 g/t and 50 g/t of dry residue but in some cases can reach several hundred grams per tonne. If this step does not achieve sufficient water recovery, the process can be enhanced by the use of centrifugal machines or filters. Centrifugation will increase the effect of gravity and improve the settling rate.

Two types of filters can be used to separate solids from liquid: vacuum-type filters and pressure-type filters, the latter being more efficient at treating material with a higher fines/clay content that retains water and which can block vacuum filter products. The use of these technologies should provide water with a low suspended solids content that can be recycled into the plant processes.

Cross-media effects

Use of chemicals.

Technical considerations relevant to applicability

Generally applicable.

Economics

No information provided.

Driving force for implementation

- Environmental regulation requirements.
- Techno-economic streamlining of processes.

Example plant

Plant F (FR).

Reference literature

No reference literature reported.

9.3.1.2.2 Techniques to prevent and reduce emissions from nickel ore and concentrates drying

Description

The techniques to consider are:

- hot ESP (see Section 2.12.5.1.1);
- bag filter (see Section 2.12.5.1.4).

Technical description

In the rotary dryers, the hot gas produced by the combustion of fuel in a separate chamber or recycled gas is placed in contact with the wet concentrate or feed mixture and the water contained is evaporated to the gas. The flame of the burner has no direct contact with the feed mixture. The combustion gas is cooled to a temperature of 500 °C before entering the drying drum. Cooling has to be carried out in order to prevent ignition of sulphides. If sulphides ignite and oxidise, the heat value of the concentrates decreases and sulphur dioxide is formed. Thus ignition has to be prevented by cooling the drying gas in order to minimise the formation of sulphur dioxide.

Sulphur oxidation prevention may also be carried out using nitrogen protection and using low temperatures and recycling gases, for instance from the anode furnace. The flue-dusts from the off-gas after the rotary dryer are removed using an electrostatic precipitator and a bag filter. Collected dusts are returned to the process stream as raw material.

In the steam dryers, the operational steam temperature is 130–214 °C. The throughput of the steam dryer is dependent on the pressure/temperature of the steam; by increasing the pressure to 18–20 bar the capacity can be increased. A small amount of carrier air or nitrogen (to prevent oxidation) is introduced into the dryer to extract the water of the concentrate. The amount of air/off-gas exiting a steam dryer is much smaller than that of the rotary dryer and it is treated for dust removal in a bag filter.

The ESP is the most common dust abatement device for cleaning hot smelter waste gas, and the bag filter for cooled gas.

Achieved environmental benefits

- Reduction of dust and metals emissions.
- Recovery of raw materials as collected dust is reused in the process.
- When an indirect steam coil dryer is used, the temperature is so low that no ignition takes place and thus SO₂ formation is prevented.

Environmental performance and operational data

In order to decrease the fossil fuel use, the direct rotary drum dryer may use recycled gas from other parts of the process, but it also needs some fuel to be combusted in order to generate the heat needed for drying.

Steam coil dryers use the steam recovered in the waste heat boiler from primary smelting and the conversion of off-gases. The steam consumption is about 150–180 kg per tonne of concentrate depending on the moisture of the concentrates and possible secondary feed materials.

The dryer off-gases of Plant A are dedusted by an electrostatic precipitator and bag filter to reduce the release of particulates into the atmosphere. Operational and performance data are summarised in Table 9.16.

Table 9.16: Emissions from a rotary dryer in a nickel production plant

Plant	Dryer type	Capacity	Heating	Off-gas treatment	Emissions (Min.–Avg.–Max.)
Plant A	Rotary dryer	60 t/h	Heavy oil ~ 10 kg/t feed	Hot ESP and bag filter	Continuous measurements Gas flows: 53 070–66 350–75 510 Nm ³ /h as daily average Dust: 0.02–0.21–3.59 mg/Nm ³ as daily average SO ₂ : 8–188–481 mg/Nm ³ as daily average
<i>Source:</i> [378, Industrial NGOs 2012]					

Cross-media effects*Bag filter and ESP*

Increase in energy use.

Technical considerations relevant to applicability

Hot ESPs and bag filters are generally applicable to new and existing plants taking into consideration the dryer off-gases. The types of dryers used depend on site-specific conditions such as the reliability of the steam supply. Usually smelters are reliable steam suppliers because smelting processes are continuous processes.

Economics

No information provided.

Driving force for implementation

- Environmental regulation requirements.
- Recovery of raw materials.

Example plant

Plant A (FI).

Reference literature

[378, Industrial NGOs 2012]

9.3.1.3 Pyrometallurgical transformation processes**9.3.1.3.1 Techniques to reduce emissions from the charging of furnaces in primary nickel production****Description**

The technique to consider is the use of enclosed conveying systems such as pneumatic dense phase conveyor and air slide; the loss-in-weight feeder and a concentrate burner.

Technical description

In the non-ferrous smelter processes, it is critical to rely on the feeding system to provide as stable a feed as possible.

In the pneumatic dense phase conveyor, the material is conveyed without fluidisation, in batches. This conveying system has low transport air requirements.

Loss-in-weight feeders provide a stable mass flow to the air slide which transports the material into the concentrate burner. A loss-in-weight feeder is a gravimetric feed system which consists of a feed bin and a dosing bin provided with a screw conveyor underneath. The feed mixture drops from the loss-in-weight feeder via a feed chute onto the air slide. The air slide transports the feed mixture in a sealed space to the concentrate burner of the flash smelting furnace and evens out small fluctuations in the feed quantity. The operation of the air slide is noise-free and dust-free. The angle of the air slide slope can be adjusted and the air slide is provided with an automatic dome valve. The fluidising air flows together with the feed mixture into the flash smelting furnace. The air slide system can also work in two stages, where the first air slides gather feed mixture from loss-in-weight units and discharge it to a feed chute where dusts are introduced. The feed chute is for the proper mixing of feed before it is conveyed via the final air slide to the burner.

Concentrate burners are specifically designed for high oxygen enrichment and even distribution of concentrate into the reaction flame. The main function of the concentrate burner is to properly mix the solid feed and process gas. The good combustion of the feed mixture in suspension is ensured by accurate and simultaneous feed mixture and process gas speed controls, enabled by the state-of-the-art concentrate burner.

Achieved environmental benefits

Reduction of diffuse emissions.

Environmental performance and operational data

In Plant A, carrier gas from the pneumatic conveyor is directed to concentrate dryer off-gas treatment (hot ESP and bag filter), see emissions data in Section 9.3.2.2.

Cross-media effects

No information provided.

Technical considerations relevant to applicability

Generally applicable.

Economics

The energy usage and the costs for the ventilation are very low.

Driving force for implementation

Prevention of dusting in the workplace.

Example plant

Plant A (FI).

Reference literature

[310, Makinen T., Taskinen P. 2006]

9.3.1.3.2 Techniques to prevent and reduce emissions from the DON process

Description

The techniques to consider are:

- waste heat boiler and hot ESP (see Section 2.12.5.1.1) followed by wet ESP (see Section 2.12.5.1.2), mercury and arsenic removal system (see Section 2.12.5.5) and sulphuric acid plant (see Sections 2.12.5.4.1 and 2.12.5.4.2);
- wet scrubber (see Sections 2.12.5.1.6 and 2.12.5.2.2) or bag filter (see Section 2.12.5.1.4) with lime injection;

- hot cyclone and Venturi scrubber with sodium hydroxide solution;
- covered and hooded launders.

Technical description

The continuous off-gas flow leaves the furnace through the uptake shaft and is cooled in the forced circulation waste heat boiler (also called heat recovery boiler) consisting of a radiation section followed by a convection section. The heat recovery boiler is a forced circulation boiler producing saturated steam. Part of the flue-dust settles in the boiler. The rest of the flue-dust is removed in an electrostatic precipitator. Dusts removed in the waste heat boiler and in the electrostatic precipitator are recycled back into the flash smelting furnace with the primary feed.

The off-gas has a high, non-fluctuating sulphur dioxide concentration and SO_2 is recovered from the gas mainly by conversion to sulphuric acid at the sulphuric acid plant after dust removal and gas cleaning. It is possible to recycle weak acid collected in the gas washing section back into the furnace by injecting it into the uptake shaft in order to decompose it back to SO_2 , oxygen and water so that the SO_2 generated can be recovered in the acid plant.

The slag and matte launders, tapping openings and granulating pools are hooded for collection of diffuse gases. Ventilation gases are cleaned using a wet scrubber or with dry lime injection before bag filters.

Granulation gas is cleaned using sodium hydroxide solution and a high-pressure multi-Venturi scrubber. The SO_2 removal efficiency mainly depends on the pH and solution to gas ratio, and the dust removal efficiency mainly depends on the solution pressure in the scrubbing nozzle. If the gas contains CO_2 , the pH has to be lower than 7, but, if the gas is CO_2 -free, the pH may be higher. The bleed solution from scrubbing is used for neutralisation of granulation water and the bleed from granulation goes to the effluent plant.

Distributed control systems (DCS) are used to control the material feed rate, critical process and combustion conditions and the addition of gases. Several parameters such as temperature, furnace pressure (or underpressure) and gas volume or flow are measured to allow processes to be controlled and alarms are provided for critical parameters.

Slag and matte are analysed on the basis of samples taken at intervals so that the control of the process conditions is kept as smooth as possible.

The DON smelting process is continuous and no ladle transportation is needed, and matte and slag are transferred via covered and hooded launders

Achieved environmental benefits

- Reduction of diffuse emissions.
- Reduction of dust, metals and sulphur dioxide emissions.
- The heat recovered by the waste heat boiler is used as steam and electricity. The steam produced from the heat recovery boiler is used for drying, other production needs or for the generation of electrical energy or district heating.
- The SO_2 is recovered in the form of sulphuric acid product at the acid plant using the double contact/double absorption process.
- Flue-dusts collected in the dust removal systems (boiler and electrostatic precipitator) are recycled back to the smelting furnace.
- Oxygen enrichment and utilisation of the feed material's inherent chemical energy for smelting allow a reduction in the quantity of fuel used and the associated reduction in greenhouse gas emissions.

Environmental performance and operational data

Process off-gases from the smelting furnace of Plant A are cooled in a waste heat boiler; heat is recovered as high-pressure steam which is distributed for use in other processes. The cooled off-

gases are then directed to a hot ESP for dust capture, before entering the acid plant, and SO₂ fixation.

Ventilation hoods are used at slag tapholes; ventilation air is directed to a centralised bag filter before release to atmosphere. Continuous dry lime injection is used to lower SO₂ emissions and to enhance dedusting. The slag launder is covered with lids to reduce the environmental impact (fumes). Slag is further processed in an EAF for metals recovery.

Ventilation gases of matte tapholes are directed to a Venturi scrubber for SO₂ abatement with sodium hydroxide. A hot cyclone captures coarse dust before the scrubber; the fines are captured in the scrubbing solution.

Operational and performance data are summarised in Table 9.17.

Table 9.17: Emissions from the DON process

Plant	Furnace type	Capacity	Primary gas handling	Primary gas treatment	Secondary gas collection sources	Secondary gas treatment	Emissions (Min.-Avg.-Max.)
Plant A	DON FSF, single jet burner, oxygen enrichment 80–90 %	1320 t/d	WHB and ESP steam 40 t/h	Double contact/double absorption acid plant	Ventilation gases from slag tapholes	Bag filter with dry lime injection	Dust: 0.01–0.14–5 mg/Nm ³ (continuous) SO ₂ : 40–337–721 mg/Nm ³ (continuous)
					Ventilation gases from matte tapholes	Hot cyclone Venturi scrubber with NaOH	SO ₂ : 50–100–300 mg/Nm ³ (periodic measurement)
Source: [378, Industrial NGOs 2012], [409, Finland 2013] [378, Industrial NGOs 2012], [409, Finland 2013]							

Cross-media effects

- Increase in energy consumption.
- Use of chemicals.
- Wet gas cleaning systems generate waste and waste water that require treatment before discharge.

Technical considerations relevant to applicability

Generally applicable.

Economics

No information provided.

Driving force for implementation

- Reduction of emissions of dust, metals and SO₂.

- Recovery of sulphur.

Example plant

Plant A (FI).

Reference literature

[310, Makinen T., Taskinen P. 2006], [410, Mäkinen et al. 2005], [411, Taskinen et al. 2001]

9.3.1.3.3 Techniques to prevent and reduce emissions from the EAF

Description

The techniques to consider are:

- afterburner (see Section 2.12.5.2.1);
- wet scrubber (see Sections 2.12.5.1.6 and 2.12.5.2.2) or bag filter (see Section 2.12.5.1.4) with lime injection;
- hot cyclone and Venturi scrubber with sodium hydroxide solution;
- covered and hooded launders.

Technical description

The slag is tapped periodically from the smelting furnace along the cooled and covered slag launder through the already charged coke layer into the electric furnace.

Slag from the electric furnace is tapped, granulated and transported to the slag storage and used for civil engineering purposes.

Electric furnace off-gas, which contains carbon monoxide, is first incinerated in a water-cooled combustion chamber with excess air and then cooled. Before entering the stack, the gas is cleaned with $\text{Ca}(\text{OH})_2$ injection and a bag filter or by scrubbing.

Achieved environmental benefits

- An inert slag by-product is produced.
- Reduction of CO and SO₂ emissions to air by gas cleaning.

Environmental performance and operational data

Process off-gases from the slag cleaning furnace in Plant A are incinerated and cooled with dilution air before being directed to the centralised bag filter. Ventilation hoods are used at slag tapholes; ventilation air is directed to the same centralised bag filter before release to atmosphere. Continuous dry lime injection is used to lower SO₂ emissions and to enhance dedusting.

The discard slag launder is covered with lids to reduce the environmental impact (fumes). Discard slag is granulated with water.

Ventilation gases from matte tapholes are directed to the Venturi scrubber for SO₂ abatement with sodium hydroxide. A hot cyclone captures coarse dust before the scrubber; the fines are captured in the scrubbing solution.

Operational and performance data are summarised in Table 9.18 and Table 9.19 [378, Industrial NGOs 2012].

Table 9.18: Emissions from an EAF

Plant	Furnace type	Feed	Off-gas treatment	Emissions (Min.–Avg.–Max.)
Plant A	EAF, 3 electrodes (Søderberg)	Flash furnace slag	Post-combusting before centralised bag filter	Dust: 0.01–0.14–5 mg/Nm ³ (continuous) SO ₂ : 40–337–721 mg/Nm ³ (continuous)

Table 9.19: Emissions from slag taphole and matte taphole granulation gas

Plant	Furnace	Ventilation source	Off-gas treatment	Emissions (Min.–Avg.–Max.)
Plant A	EAF	Slag taphole	Centralised bag filter with dry lime injection	Dust: 0.01–0.14–5 mg/Nm ³ (continuous) SO ₂ : 40–337–721 mg/Nm ³ (continuous)
		Matte taphole granulation gas	Hot cyclone Venturi scrubber with NaOH	SO ₂ : 20–80–250 mg/Nm ³ (periodic measurement)

Cross-media effects

- Increase in energy use.
- Use of chemicals.
- Wet gas cleaning systems generate waste and waste water that require treatment before discharge.

Technical considerations relevant to applicability

Generally applicable.

Economics

No information provided.

Driving force for implementation

Environmental regulation requirements.

Example plants

Plant A (FI) and a plant in Fortaleza (Brazil).

Reference literature

[310, Makinen T., Taskinen P. 2006], [410, Mäkinen et al. 2005], [411, Taskinen et al. 2001]

9.3.1.3.4 Techniques to prevent and reduce emissions from a nickel converting process

Description

The techniques to consider are the use of capture hoods, performing operations under negative pressure (see Section 2.12.4.3) and to use of a bag filter (see Section 2.12.5.1.4).

Technical description

The nickel converting process of Plant F in France consists of oxidising and sulphurising raw ferro-nickel from the smelting furnace to produce nickel matte. For this operation, two Peirce-Smith converters are used in a two-step operation with slag recycling. The nickel-containing matte is further processed in another French plant for the production of high-purity nickel salts and nickel metal using chloride leaching and electrowinning. Iron is removed as ferric chloride by solvent extraction and some cobalt chloride is also extracted.

During blowing, the process gas is expelled from the converter and is captured. The extraction fan control is adjusted to keep the pressure at the mouth of the converter below atmospheric pressure to avoid gas from escaping outside the fume extraction system. The fume extraction system is connected to bag filters further downstream. During settling or tapping periods, the gas exhaust equipment is also adjusted to avoid emission into the converter bay.

The exhaust gas is then cooled down by a heat exchanger under natural or forced convection and the collected dust filtered by a bag filter.

SO₂ emissions are not an issue as their concentrations in the process fumes are insignificant due to the thermodynamic equilibrium of the process.

Achieved environmental benefits

- Metal-rich dust can be collected from the emissions to air and recycled in the ore smelting process.
- Particulate emissions to air are significantly reduced.

Environmental performance and operational data

Dust emission levels lower than 15 mg/Nm³ were reported.

Liquid effluents are of little importance because the gas treatment process is a dry process and the formation of liquid waste only results from the cooling of certain parts of the equipment (condensation).

The largest quantity of waste is solid slag which amounts to some 75 000 tonnes for an annual nickel matte production of 15 000 tonnes. Slag is tapped from the 60-tonne converter and then transported to a dedicated area where it is allowed to cool down to ambient temperature. Finally, this slag (categorised as waste) is transferred to a dedicated storage area.

Dust from the management of emissions to air is collected downstream. This dust, which is mostly composed of metallic and non-metallic oxides (FeO, NiO, MgO and SiO₂), is collected in bag filters. The dust requires a specific treatment to be consolidated for further reintroduction into the process (at an earlier step into the ore smelter). Among the different binder options, concrete may be used as it is easy to handle and operate.

Other solid waste materials which are produced in the converting process are ladle skulls and scrap. These materials are recycled in the 60-tonne converter.

Cross-media effects

Increase in energy use.

Technical considerations relevant to applicability

Generally applicable.

Economics

No information provided.

Driving force for implementation

Environmental regulation requirements.

Example plant

Plant F (FR).

Reference literature

No reference literature reported.

9.3.1.4 Hydrometallurgical nickel refining processes**9.3.1.4.1 Techniques to reduce emissions from atmospheric and pressure leaching****Description**

The techniques to consider are:

- sealed or closed process equipment (reactors, settlers and pressure autoclaves/vessels);
- oxygen or chlorine instead of air in leaching stages for minimising the process gas flow and maximising the raw material recovery;
- bag filters (see Section 2.12.5.1.4) or wet scrubbers (see Sections 2.12.5.1.6 and 2.12.5.2.2);
- online monitoring and control for critical leaching and abatement equipment parameters.

Technical description

The leaching process equipment (reactors, settlers, pressure autoclaves/vessels, flush tanks) is sealed and process gases are collected and treated in abatement equipment like bag filters or wet scrubbers (see Section 2.12.5) before release to atmosphere. The residues from abatement equipment are re-leached and the effluents are fed to the leaching stages to replace or decrease the water usage.

The online monitoring and control of the critical parameters of the leaching process and abatement equipment is necessary to maximise nickel recovery and at the same time minimise emissions.

Achieved environmental benefits

- Reduction of dust and metals emissions.
- More efficient recovery of nickel by recycling the abatement residues.

Environmental performance and operational data

The main operational and performance data for atmospheric and pressure leaching plants are summarised in Table 9.20 and Table 9.21.

Table 9.20: Emissions from sulphate-based atmospheric and pressure leaching

Plant	Process type	Capacity	Abatement technique	Nickel (mg/Nm ³)			Method to obtain data	Type of average
				Min.	Avg.	Max.		
Plant C	Atmospheric and pressure leaching / sulphate / oxygen	66 000 t Ni/yr	Wet gas scrubbers	0.01	0.2	1.3	Periodic monitoring (12 times per year)	Average over the sampling period
				< 1000 kg/yr				

Source: [378, Industrial NGOs 2012]

Table 9.21: Emissions from atmospheric and pressure leaching using chlorine gas

Plant	Process type	Capacity	Abatement technique	Chlorine (kg/h)			Method to obtain data	Type of average
				Min.	Avg.	Max.		
Plant E	Atmospheric and pressure leaching – using chlorine gas	92 000 t Ni/yr	Wet gas scrubbers	0.1	0.23	0.87	Periodic monitoring (52 times per year)	Average over the sampling period

Source: [378, Industrial NGOs 2012]

Cross-media effects

Increase in energy use (minor increase in energy consumption when using wet gas scrubbers).

Technical considerations relevant to applicability

Bag filters and wet scrubbers are generally applicable.

Economics

Plant C commissioned new wet gas scrubbers in 2009 at a cost of roughly EUR 500 000 each.

Driving force for implementation

- Reduction of emissions.
- Raw material savings.

Example plants

Plant C (FI) and Plant E (NO).

Reference literature

No reference literature provided.

9.3.1.4.2 Techniques to reduce emissions from solvent extraction refining (sulphate route)**Description**

Techniques to reduce emissions from solvent extraction (SX) when refining the solutions from the leaching stage are one or a combination of the techniques mentioned below.

For low shear mixers:

- use of a low shear mixer for the solvent/aqueous mixture to optimise the droplet size and minimise contact with air to reduce the amount of solvent that is evaporated and to promote the dissolution of the metal complex;

- use of covers for the mixer and separator and settlement stages to reduce emissions of VOCs to air and carry-over in the aqueous phase;
- use of abatement equipment to treat the ventilation air (condensers, coolers, carbon filters and biofilters);
- use of low shear mixers and variable speed pumping to reduce the energy consumption of the system.

For high shear mixers:

- conventional mixer-settlers with high shear pump-mix turbine impellers;
- completely sealed tanks prevent emissions, and are connected to a central ventilation fan;
- simple abatement with cooling towers followed by settling duct to recover condensed VOCs before the fan.

Technical description

Sealed or covered systems are used to prevent the emission of solvent fumes from the SX shells.

Sophisticated treatment of the ventilation air is also possible but, due to the high air volumes, low VOC content and high costs, it is not usually implemented. A cooling tower is installed in the ventilation pipe from the loading and stripping area. The water containing VOCs can then be used as feed water into the SX process. The emission of VOCs from the extraction is approximately proportional to the amount of ventilation air. To keep the airflow in the ventilation system as low as possible, without compromising the working environment for operators, it is therefore important to keep emissions as low as possible.

Achieved environmental benefits

- Minimisation of VOC emissions to air.
- Low shear mixers and variable speed pumping reduce the energy consumption of the system.

Environmental performance and operational data

The main operational and performance data for solvent extraction plants in nickel production are summarised in Table 9.22.

Table 9.22: Emissions of VOCs from solvent extraction refining

Plant	Process type	Capacity	Abatement technique	VOCs (mg/Nm ³)			Method to obtain data	Type of average
				Min.	Avg.	Max.		
Plant C	Co and CaSX/sulphate	To treat up to 140 m ³ /h nickel sulphate solution	Sealed/covered shells, low shear mixer, variable speed pumps	3	42	134	Periodic monitoring (twice a year)	Average over the sampling period
				< 100 t/yr				
				3.5 kg/h	4.9 kg/h	7.0 kg/h		
				< 70 t/yr				

Source: [378, Industrial NGOs 2012]

Cross-media effects

No information provided.

Technical considerations relevant to applicability

Shell covers are applicable to new and existing extraction shells.

Economics

No information provided.

Driving force for implementation

Reduction of VOC emissions.

Example plants

- Low shear mixing: Plant C (FI).
- High shear mixing: Plant E (NO).

Reference literature

No reference literature provided.

9.3.1.4.3 Techniques to reduce emissions from the nickel matte refining process using ferric chloride leaching with chlorine (chlorine route)

Description

The technique to consider is the use of a bag filter (see Section 2.12.5.1.4).

Technical description

The nickel matte refining process is described in Section 9.1.1.3.8.

Achieved environmental benefits

- By-products (or wastes) are sold on as chemical intermediates for reuse.
- The generation of non-usable process wastes is minimised.

Environmental performance and operational data

The principal environmental performance of Plant B's refining process is outlined below (data averages from 2007 to 2011)

The energy consumption of Plant B's refining process is in the range of 20 GJ per tonne of nickel produced.

Table 9.23: Dust emissions from the nickel matte refining process (chlorine route) in Plant B

Process type	Abatement technique	Nickel (mg/Nm ³)			Method to obtain data	Type of average
		Min.	Avg.	Max.		
Production of nickel chloride salts	Bag filter	0.04	0.53	1.4	Periodic monitoring	Average over the sampling period
<i>Source: [378, Industrial NGOs 2012]</i>						

Plant B's refining process does not produce a significant volume of solid residues. The total solid waste production is 22 kg/t Ni.

Cross-media effects

No information provided.

Technical considerations relevant to applicability

No information provided.

Economics

No information provided.

Driving force for implementation

No information provided.

Example plants

Plant B (FR).

Reference literature

No reference literature provided.

9.3.1.4.4 Techniques to reduce emissions from electrowinning**Description**

The techniques to consider are:

- online monitoring of critical process parameters like temperature, flow and use of electricity;
- collection and reuse of chlorine gas and use of a dimensionally stable anode (DSA);
- covering of cells with polystyrene beads to prevent the release of aerosols to air;
- use of foaming agents to cover the cells with a stable foam layer.

Technical description

The electrowinning process produces gases at the anode and may produce metal-containing acid mist due to bubbles in the electrolyte that burst at the surface of the solution.

During chloride-based electrowinning, the chloride ions will be drawn to the anodes and be discharged as chlorine gas. The anode, a so-called dimensionally stable anode (DSA), is contained in a diaphragm and enclosed by a collection hood. The chlorine gas collected directly from the anode is blown into a central system and returned to the leaching stage. During the electrowinning, polystyrene beads are used as a cover on top of the cells, to prevent mist from bubbles in the electrolyte solution that burst at the surface from entering the room atmosphere and finally the air. It is important that the entire cell is continuously covered with polystyrene beads. The electrolyte is separated into two phases after passing through the electrowinning tank. Chlorine-containing anolyte from the anodes is transported to a tank for removal of chlorine, and then mixed with the chlorine-free anolyte from the overfall in the electrowinning tank. The chlorine gas is finally reused in the process.

During sulphate-based electrowinning, the following reaction takes place: $\text{NiSO}_4 + \text{H}_2\text{O} \rightarrow \text{Ni} + \text{H}_2\text{SO}_4 + \frac{1}{2} \text{O}_2$. Nickel sulphate solution is fed into the diaphragm bags where cathodes are located. Nickel is precipitated on the cathodes. Sulphate ions react with water and generate sulphuric acid, which is recycled to the leaching stage. Oxygen gas from the anode is released to the workplace environment and via ventilation to the atmosphere. Anode gases contain nickel and acid mists. Emissions of these substances are minimised by keeping a stable foam layer on the surface of the solution in the cells.

Achieved environmental benefits

- Reduction of chlorine gas, acid and metal emissions to air.
- Reduction of energy use (online monitoring and optimisation of parameters).

Environmental performance and operational data

In Plant E, chlorine gas is collected and reused, with no direct emission of chlorine to air from electrowinning (indirect emissions to air from the reuse of chlorine in other leaching or purification steps will occur, and will be accounted for in the relevant process step). The energy consumption in the refining process is about 20 GJ/Mt of nickel produced.

Table 9.24: Emissions from the electrowinning process

Plant	Process type	Capacity	Abatement technique	Nickel (mg/Nm ³)			Method to obtain data	Type of average
				Min.	Avg.	Max.		
Plant C	Sulphate-based electrowinning	20 000 t Ni/yr	Stable foam layer on the surface of the solution in the cells	0.3	0.5	0.8	Periodic monitoring (24 times per year)	Average over the sampling period
				1500 kg/yr		2500 kg/yr		
Plant E	Hydrometallurgical purification process and chlorine-based electrowinning	92 000 t Ni metal/yr	Covering of electrowinning cells with polystyrene beads to prevent acid/metal mist emissions to air	0.3		0.5	Periodic monitoring (3 times per year)	
					880 kg/yr	1500 kg/yr		

Source: [378, Industrial NGOs 2012]

Cross-media effects

Very minor increase in energy use for collection of chlorine gas.

Technical considerations relevant to applicability

There are a very limited number of chlorine-based electrowinning sites for nickel production in Europe (all known sites are represented in the BREF). This will limit the relevance of chlorine collection and reuse in other industries or production sites.

Economics

DSAs imply additional maintenance and purchase costs.

Internal reuse of chlorine gas and sulphuric acid reduces the need to purchase them for the process.

Driving force for implementation

Reduction of chlorine gas, acid and metal emissions to air.

Example plants

Plant C (FI) and Plant E (NO).

Reference literature

[412, Norwegian Environment Agency 2012]

9.3.1.4.5 Techniques to reduce emissions to air from the carbonyl process**Description**

The techniques to consider are:

- collection of off-gases (see Section 2.12.4.3);
- afterburner (see Section 2.12.5.2.1);
- bag filter (see Section 2.12.5.1.4).

Technical description

The off-gases from the carbonyl process (containing a carbon monoxide and nickel carbonyl mixture and hydrogen) and those from system purges and plant blowdown are collected and piped to a central vent gas manifold. The vent gas manifold then feeds the waste gases in a controlled manner to the combustion chamber for thermal oxidation.

The combustion chamber comprises an air-cooled steel shell, lined with a heat-resistant refractory material. The combustion chamber is heated by two high-intensity burners, one fuelled by natural gas (fuel burner) and the other by waste gas (residual hydrogen from the kiln reduction stage). The gas burners are identical in design and are mounted tangentially to the furnace; this design promotes a swirling action in the combustion chamber, aiding full combustion. Each of the burners has concentric annuli, one to water-cool the burner and one to admit induced air for quenching the hot gases if required. In the combustion process, carbon monoxide and nickel carbonyl are mixed with air in the burner and combusted.

The nickel oxide formed is solid and is in the form of fine dust particulates in the combustion gas stream. The non-toxic waste (purge) hydrogen is fed into to the manifold as a support fuel to the waste gas burner. The pressure of the waste hydrogen is monitored and controlled by a water lute at ground level. In the event of a flame failure, the lute pot is vented to atmosphere via a discharge point. Hydrogen gas reacts as outlined below.

Three basic controls are applied to ensure that the toxic and flammable gases are destroyed without overheating the combustion chamber:

- The primary control is to ensure that a minimum temperature is maintained to oxidise any toxic gases present; this is done by adjusting the gas flow rate to the fuel burner.
- The second control is designed to ensure that the maximum operating temperature of the combustion chamber does not become too hot for the materials used to construct the furnace. To control this temperature, the primary air directed to the return carbon monoxide burner is increased, and, if that is insufficient, secondary air is admitted to the burner.
- The third control ensures that the maximum permitted temperature of the gases leaving the combustion chamber is not exceeded; as the temperature approaches the maximum level, a pair of dampers starts to open to admit quench air into the furnace and so dilute the hot gas with cold air.

The outlet duct of the combustion chamber is fitted with heat-resistant steel blinds. The angle of the blinds can be changed to control the flow rate of combustion gases out of the chamber and, if necessary, to close the outlet ducting. The outlet duct enters an exhaust. The combustion gases and particulates flow through the outlet blinds into the exhaust manifold which feeds into the gas filter system.

The combustion gas stream is passed through a reverse jet filter system, which consists of filter vessels each with an inlet and outlet damper. Each filter contains filter bags capable of retaining particles of dust down to submicron size, whilst still allowing the passage of the main gaseous stream. The dust filters have a burst bag detection system and are self-cleaning using a reverse jet pulsing system.

The collected particles descend into bunkers situated below the filters, which are discharged via rotary valves into slurry pots. Here the dust mixes with a continuous flow of water. The resultant slurry is discharged to the refinery effluent treatment plant.

Achieved environmental benefits

- Reduction of nickel and carbon dioxide emissions to air.
- Recovery of nickel from the waste gas stream, improving natural resource management.
- Reuse of hydrogen waste gas from the carbonyl process as support fuel for the combustion.

- Obtaining a stabilised kiln residue that can be further processed by high-pressure nickel extraction.
- Following high-pressure nickel extraction, cobalt/copper extraction can be performed. Copper/cobalt extraction then leaves a high concentration of PGMs (platinum group metals). PGM extraction can then be undertaken, resulting in the complete extraction of metals from the ore.

Environmental performance and operational data

Emissions data from the carbonyl process operated at Plant D are summarised in Table 9.25.

Table 9.25: Emissions from the carbonyl process

Plant	Process type	Abatement technique	Pollutant	Min. (mg/Nm ³)	Avg. (mg/Nm ³)	Max. (mg/Nm ³)	Method to obtain data	Type of average
Plant D	Carbonyl process	Afterburner followed by a bag filter	Dust	0.03	0.98	7.4	Continuous monitoring	Daily average
			Ni	0.003	0.06	0.3	Periodic monitoring (twice a year)	Average over the sampling period
			CO	265	297	329		
			SO ₂	13.6	18.5	23.4		
			NO _x	4.9	6.3	7.7		
<i>Source: [378, Industrial NGOs 2012]</i>								

Cross-media effects

Increase in energy use (natural gas consumption).

Technical considerations relevant to applicability

Generally applicable.

Economics

No information provided.

Driving force for implementation

- Complete oxidation of toxic nickel carbonyl gas to particulate nickel oxide.
- Highly efficient recovery of metals from the primary carbonyl process coupled with further recovery of metals from material recovered by the off-gas and waste water treatment processes.
- Environmental regulation requirements.

Example plants

Plant D (UK).

Reference literature

No reference literature provided.

9.3.1.4.6 Techniques to reduce emissions from hydrogen reduction processes when producing nickel powder and nickel briquettes (pressure processes)

Description

The techniques to consider are:

- sealed or closed process equipment (reactors, settlers and pressure autoclaves/vessels, powder conveyors, product silos);
- bag filters (see Section 2.12.5.1.4) or wet scrubbers (see Sections 2.12.5.1.6 and 2.12.5.2.2);
- online monitoring and control for critical reduction processes and abatement equipment parameters.

Technical description

In general, the hydrogen reduction process is as follows (more detailed process descriptions are presented in Section 9.1.1.3). Purified nickel solution from the solvent extraction is used as a 'raw material' of the hydrogen reduction process. If necessary, ammonia and ammonium sulphate are added to the nickel sulphate solution. The mixed feed solution is reduced with hydrogen in the autoclaves to produce metallic nickel powder. The powder is sold or can be sintered into briquettes. The sulphuric acid generated in the reduction process is neutralised by ammonia. The ammonium sulphate solution formed has a small amount of nickel and cobalt, which are precipitated with hydrogen sulphide for further treatment. The ammonium sulphate is recovered by crystallisation and drying.

The reduction process is a batch process and takes place in various autoclaves at a high temperature (about 200 °C) and high pressure (about 30 bar). The hot, water-containing autoclave gases are treated in the gas scrubbers using sulphuric acid as a washing reagent. The process conditions make the recovery of ammonia challenging. The continuous monitoring and control of critical process and scrubber parameters is essential for reducing ammonia emissions to air.

The production of nickel briquettes from powder includes several stages where the formation and release of dust to the workplace environment is possible. All the conveyors, silos and process equipment need to be enclosed and the off-gases treated by abatement equipment.

Achieved environmental benefits

Prevention or reduction of nickel and ammonia emissions to air.

Environmental performance and operational data

The main operational and performance data for hydrogen reduction processes are summarised in Table 9.26.

Table 9.26: Emissions from hydrogen reduction processes when producing nickel powder and briquettes

Plant	Process type	Capacity	Abatement technique	Pollutant	Min.	Avg.	Max.	Method to obtain data	Type of average
Plant C	Hydrogen reduction, Ni powder and briquette production	40 000 t/year	Bag filters (for nickel dust) and wet scrubbers (for ammonia)	Ni (mg/Nm ³)	0.05	0.6	3.7	Periodic monitoring (12 times per year)	Average over the sampling period
					< 1000 kg/yr				
					< 200 t/yr				
<i>Source:</i> [378, Industrial NGOs 2012]									

Cross-media effects

Minor increase in energy consumption when using abatement equipment.

Technical considerations relevant to applicability

Abatement techniques for emissions to air are applicable to new and existing hydrogen reduction plants.

Economics

No information provided.

Driving force for implementation

Reduction of emissions.

Example plants

Plant C (FI).

Reference literature

No reference literature provided.

9.3.1.5 Waste water**9.3.1.5.1 Techniques to prevent the generation of waste water**

See Section 2.12.6.1.

9.3.1.5.2 Waste water treatment**Description**

The techniques to consider to treat effluent water, with the exception of cooling water, prior to discharge are:

- pretreatment techniques, in some cases;
- chemical precipitation;
- sedimentation or flotation;
- filtration.

Technical description

The production of non-ferrous metals is associated with the generation of different liquid effluents.

Pretreatment techniques

In some cases, depending on the sources, it might be necessary to pretreat waste water.

Waste water collected in a sewer system is usually contaminated with coarse and suspended particles, dissolved metals and salts. It can consist of rain and sprinkling water running off roofs, roads and storage yards, of drainage water from groundwater remediation and cooling towers, of industrial cleaning activities' water and of neutral process waters.

Coarse, floating fractions in the sewer water have to be removed by sieves before further treatment of the water. Coarse, settling fractions in the sewer water are first removed in a buffering basin or settler by making them settle, possibly with the addition of a polyelectrolyte. A rake gathers the settled particles and the gathered sludge is then filtered in a press filter or in a centrifugal filter. As this sludge usually contains valuable metals, it will be reintroduced into the production process. The water resulting from this pretreatment is further treated as described for the waste water generated by production and downstream metal processing.

Waste water from nickel production can contain suspended particles, acids, dissolved metals and salts. Also, the temperature of the water might be a cause for concern, either as incoming process water or as cooling water.

Chemical precipitation

Dissolved metals and other dissolved elements will be removed by first transferring them into an insoluble state:

- Addition of a base (e.g. sodium or calcium hydroxide) enables the precipitation of insoluble metal hydroxides, typically at a pH of 10–11.5.
- Addition of calcium hydroxide (lime milk) will co-precipitate the sulphates present in the waste water as gypsum and the fluoride as calcium fluoride. Applied at a pH of +/- 1, this can produce a type of gypsum that is clean enough for reuse.
- Addition of sulphide (e.g. disodium sulphide, sodium hydrogen sulphide, trimercapto-sulpho-triazine (TMS)) in alkaline conditions precipitates the metals as insoluble metal sulphides. This technique can also be used after hydroxide precipitation for the polishing of the waste water for Tl^+ removal.
- Addition of iron (iron sulphate or iron trichloride) polishes the water for arsenic; simultaneous addition of a base might be necessary to maintain an optimal pH of +/- 10.
- Precipitation is enabled by the addition of a polyelectrolyte that makes particles collide and fuse to form larger particles.

For complex waste water, a multistage treatment at different pH levels and with a combination of the techniques described above might be necessary.

Sedimentation/flotation and filtration

Suspended particles, precipitated metals, gypsum and calcium fluoride are removed from the waste water by settlers. In order to stimulate this process, a polyelectrolyte is added. The sludge which is separated from the purified water in the settler is filtered in a press filter or a centrifugal filter in order to produce a dewatered cake that can either be disposed of or be reintroduced into the metal production process in order to recover valuable metals. In larger plants, the treatment of the different waste water flows is carried out in an end-of-pipe installation, where they are grouped and treated separately in order to maximise the metal recovery by generating two different sludges.

Before discharge, the pH of the purified water might have to be adjusted by addition of hydrochloric acid or by injection of CO_2 .

When the temperature of the purified waste water or the non-contact cooling water is too high for discharge or reuse, the water should be cooled (cooling towers, heat exchangers). Open cooling towers should not be applied for cooling the raw waste water, to prevent generation of metal content. For this reason, the conductivity must be taken into account to avoid corrosion and abrasion.

After treatment, the purified water can be reused for cooling, sprinkling and some processes. The salt content of the purified water can pose problems for reuse, e.g. calcium precipitation in heat exchangers. Attention should be paid however to the risk of legionella growth in this (usually warm) water. This can limit the reuse of water considerably.

The waste water treatment process has to be controlled by adequate measurement of relevant parameters, in order to dose the additives or to adjust flow rates. Measurements can be online, like the measurement of pH, redox potential, flow rate and conductivity. Such measurements can directly steer the dosage of additives. The metal content can be determined from a sample taken proportionally with the flow rate, e.g. from the final control of the effluent or in grab samples taken during the process for process control. Analysis can be effected quickly with AA (atomic absorption) or ICP (inductively coupled plasma); the latter technique allows for lower detection limits and a broader range of parameters. In the event of having a buffer tank and when the residence time of the waste water in the process is relatively long, point samples and an immediate analysis could be sufficient to react and to adjust the process.

Achieved environmental benefits

- Removal of suspended and coarse particles, metals, acids, sulphates and fluorides from waste water, rendering it suitable for discharge or reuse.
- Production of a sludge for reuse (pure gypsum for sale, sludge with valuable metals that can be reintroduced into the production process), thus avoiding the production of waste to be disposed of.
- Production of a sludge with a higher concentration of harmful metals (cadmium, arsenic), which reduces the amount of waste to be disposed of.
- Production of water suitable for reuse within the plant, e.g. for sprinkling, cooling, industrial cleaning and some processes.

Environmental performance and operational data

The waste water treatment plant at Plant D is designed to treat all process effluents (surface and road drainage water, plant spillages, washing water, roof run-off and rainwater) which are collected at the inlet sump. Filtrate from the operations, together with any return from the emergency tank, is also collected at this inlet sump.

The raw effluent is pumped to a caustic dosing tank where the pH is raised to 10.2 by the addition of caustic soda. The pH-adjusted effluent stream flows to the thickener where the solids are allowed to settle out of suspension to the base of the thickener.

The clarified water overflows a weir to the clarified water tank where the pH is adjusted to 9.2 using an injection of carbon dioxide. The water is then filtered using graded sand filters.

Each of the sand filters undergoes a washing process every 24 hours using fluidising air to release the solids collected and to allow the filter washing water from the clarified water tank to flush the filter. Backwash from the sand filters is collected in the washing water collection tank and then pumped via the return pumps to the inlet sump. The filtered water passes to the acid dosing tank, where its pH is adjusted to between 6 and 9 using carbon dioxide or sulphuric acid, before being discharged to the river. In the event of a high or low pH, the discharge diverts to the emergency storage tanks.

The settled solids from the thickeners are transferred to slurry holding tanks prior to being filtered using a plate and frame filter press. The filtrate is returned back to the inlet sump. The filter cake is extruded and dried on a band dryer using circulating hot air through the drying

strand. The dried solids are elevated to a product hopper before being bagged for transportation and further processing.

Plant D reports the emissions shown in Table 9.27.

Table 9.27: Emissions to water from Plant D

Pollutant	Min. (mg/l)	Avg. (mg/l)	Max. (mg/l)	Method to obtain data
Ni	0.1	0.56	3.2	Periodic composite sampling and measurement (two samples per day to make a single composite)
Soluble Ni	0.1	0.41	2.5	
Co	0.1	0.1	0.2	
Cu	0.1	0.1	0.2	
<i>Source: [378, Industrial NGOs 2012]</i>				

Plants C and A are operating in the same area. Plant A has copper and nickel smelters and Plant C has a nickel refinery (leaching, solvent extraction, electrowinning, hydrogen reduction) and a chemical plant on site. Both companies have waste water treatment plants. Plant A treats part of Plant C's surface and waste area waters.

Plant A's waste water treatment plant is described in Section 3.3.6.2. The emission values associated with this plant can be found in Table 9.28.

Table 9.28: Emissions to water from Plant A

Plant	Abatement technique	Pollutant	Minimum (mg/l)	Average (mg/l)	Maximum (mg/l)	Method to obtain data	Type of average
Plant A (copper and nickel smelter)	1) Primary settling 2) Precipitation: Metals are precipitated as metal hydroxides with sodium hydroxide (pH approx. 10.5) 3) Actiflo® treatment: I) Ferric sulphate (coagulant) is added II) Microsand is injected into the stream and mixed to form a uniform solution III) Flocculant is added to the stream IV) Heavy flocs are settled to the bottom of the settler and clean water leaves the settler as the overflow. The settlers are equipped with lamellae to improve the separation. The sludge from the bottom of the settler is pumped to hydrocyclones which separate the sand back to the process and the metal sludge is removed via the primary settling, from where it is pumped to the sludge basin and transported to the slag concentration plant	Cu	< 0.01	0.0	1.8	Continuous composite sampling	Daily average
		Ni	< 0.01	0.06	1.9		
		Zn	< 0.01	0.02	0.4		
		Pb	< 0.008	0.009	0.05		
		As	< 0.01	0.02	0.4		
		Cd	< 0.001	0.003	0.08		
		Hg	< 0.0001	0.0002	0.006		
	Flow rate	490 m ³ /h	1348 m ³ /h	3100 m ³ /h	Continuous monitoring	Yearly average	

Source: [378, Industrial NGOs 2012]

The feed to Plant C's waste water treatment plant consists of the chemical plant process waters, surface waters and refinery process waters. Treatment of the waters is as follows:

- pH control using sodium hydroxide or sodium carbonate;
- flocculant and coagulant are used if needed;
- settling: solids are recycled to the leaching stage; water is sand filtered before going to settling basins and being released to the Kokemäenjoki river.

Table 9.29: Emissions from Plant C

Plant	Abatement technique	Pollutant	Min. (mg/l)	Avg. (mg/l)	Max. (mg/l)	Method to obtain data	Type of average
Plant C (nickel refinery and chemical plant)	pH control, flocculation and coagulation if needed, settlers, sand filters	Ni	0.02	0.2	0.9	Continuous composite sampling	Daily average
		Cu	< 0.01	0.02	0.4		
		Zn	< 0.01	0.2	0.8		
		U	< 0.01	0.2	0.6		
		Pb	< 0.01	0.03	0.6		
		As	< 0.01	< 0.01	0.06		
		Flow rate	33 m ³ /h	86 m ³ /h	115 m ³ /h	Continuous monitoring	Monthly average

Source: [378, Industrial NGOs 2012]

Plant B reports the following emissions after the waste water treatment plant (physico-chemical treatment).

Table 9.30: Emissions from Plant B

Plant	Abatement technique	Pollutant	Min. (mg/l)	Avg. (mg/l)	Max. (mg/l)	Method to obtain data
Plant B	Physico-chemical treatment	Ni	0.02	0.55	1.5	Single random sampling
		Fe	< 0.01	0.2	2	
		Co	< 0.005	0.05	0.5	
		Cu	< 0.005	0.03	0.5	
		Total suspended solids	NR	0.2 kg/t Ni	NR	NR
		TVOC	NR	0.17 kg/t Ni	NR	NR

NB: The presence of chlorides in the effluent interferes with the analysis of the Chemical Oxygen Demand (COD) parameter; analytical results are therefore not representative. Plant B's refining process analyses Total Organic Carbon (TOC) instead of COD to flag the eventual presence of organic compounds in the waste water effluent.
NR = Not reported.

Source: [378, Industrial NGOs 2012]

Emissions to water from the waste water treatment plant of Plant E are reported in the following table.

Table 9.31: Emissions from Plant E

Plant	Abatement technique	Pollutant	Min. (mg/l)	Avg. (mg/l)	Max. (mg/l)	Method to obtain data	Type of average
Plant E	The first step is a ventilation tank for removal of CO ₂ by mixing and aeration at a low pH (below 5.5). The second tank is a precipitation tank using NaOH to precipitate metals as hydroxides. The solid phase is filtrated off and returned to the process, the filtrate is mixed with cooling water and sent to the sea	Ni	0.06	0.10	0.13	Continuous composite sampling	Composite sample of daily samples over one month
		Fe	0.02	0.06	0.13		
		Co	0.01	0.02	0.04		
		Cu	0.02	0.03	0.05		
		As	0.009	0.03	0.11		

Source: [378, Industrial NGOs 2012]

Plant G is a multi-metal plant using a centralised waste water treatment plant for the waste water generated (a mixture of sanitary water, process water and rainwater). A description of this waste water treatment plant, as well as emission values, can be found in Section 3.3.6.2.

Cross-media effects

- Increase in energy use.
- Use of reagents.
- Production of waste for disposal or for recycling in the shaft furnace.
- Transfer of heat from water to air.

Technical considerations relevant to applicability

The techniques to be applied have to take into consideration the specificity of the production processes, the raw materials and the local conditions. Also, the size and the flow rate of the receiving water body can play a role in the choice of the techniques to be applied.

Contact of sulphides with acidic conditions must be avoided in order to prevent the formation of hydrogen sulphide. Ferric sulphate can be added after precipitation to remove the excess sulphide.

Economics

Plant C started up its waste water treatment plant in 2002. The investment cost was about EUR 3.5 million. Annual operational expenses are about EUR 400 000.

Plant A started its new waste water treatment plant in 2009. The investment cost was about EUR 4 million. Annual operational expenses are about EUR 800 000.

Driving force for implementation

Reduction of waste water emissions, driven by regulations.

Example plants

Plant A (FI), Plant B (FR), Plant C (FI), Plant D (UK), Plant E (NO), Plant F (FR), and Plant G (BE).

Reference literature

No reference literature provided.

9.3.1.6 Process residues**9.3.1.6.1 Techniques to prevent and minimise residues and wastes****Description**

The techniques to consider are:

- reuse of the residues and wastes in the same or another process to recover metals;
- recovery in external plants;
- treatment for other useful applications, as shown in the technical description below.

Technical description

The amount of residues and wastes formed in nickel production depends mainly on the composition of the raw materials used. Raw materials contain varying concentrations of impurities that have to be precipitated and extracted in certain process steps. Some residues are registered as transported or on-site isolated intermediates according to the REACH regulation and are used as raw or construction materials in internal or external processes. The residues that cannot be reused are classified as waste and disposed of after appropriate treatment (stabilisation) to landfill according to environmental regulation requirements.

Residues formed in smelting processes are mainly iron- and silica-based slag. Usually slags contain very low concentrations of leachable metals and therefore they can be used in construction, abrasives and other purposes. The slag output is four to ten times the weight of the metal produced. The slag which cannot be reused is disposed of to landfill.

Residues formed in the hydrometallurgical leaching and purification route are precipitated in different process steps. The amount of precipitates depends mainly on the quality of the raw materials and the efficiency of the precipitation. One of the main residue fractions in the hydrometallurgical process route is iron residue (in the form of jarosite or goethite). Iron residue is mainly disposed of to landfill. The amount of iron residue produced depends entirely on the iron concentration in the raw materials. Elements other than nickel present in the plant feed need to be extracted and removed in order to achieve a pure nickel product and to avoid a build-up of such elements in the closed hydrometallurgical circuit. Some of the extracted elements are concentrated in saleable on-site isolated or transported intermediates and are registered according to the REACH regulation.

Residues from the gas treatment plant are mixed with water (very fine nickel powders are potentially pyrophoric so wetting them is a safety measure) to form a slurry which is fed directly to the on-site waste water treatment plant for treatment and recovery. Dry effluent residue from the waste water treatment plant is sent to the smelter for metal recovery. Residue from the kilns is transferred to a nickel pressure extraction system followed by copper and cobalt extraction. The resulting material is sent for further platinum group metals recovery.

Achieved environmental benefits

- Maximisation of saleable intermediates to be treated and exploited internally/externally.
- Minimisation of wastes that need to be inertised and landfilled.

Environmental performance and operational data

Typical waste flows and residues formed in nickel production at smelting and refinery stages are given in Table 9.32.

Table 9.32: Typical waste flows and residues formed in nickel production at smelting and refinery stages

Plant	Process type	Residue/waste	Process where formed	Further treatment options
A	DON and EAF smelting	Granulated slag	EAF	Final disposal / construction / abrasives
		Off-gas dust	EAF	Raw material for zinc production
		Matte Granulation off-gas dust	DON and EAF	Raw material for nickel refinery / resmelting
B	Chlorine-based leaching, electrowinning and chemical production	Sulphur residue	Matte preparation (filtration)	Raw material for sulphuric acid production
C	Sulphate-based leaching, solvent extraction, electrowinning, hydrogen reduction and chemical production	Iron residue	Leaching	Stabilisation and final disposal / feed to the nickel smelter
		Metal (Zn) carbonate residue	Solvent extraction	Stabilisation and final disposal / raw material for zinc production
		Copper residue	Leaching	Raw material for copper production
E	Chlorine-based leaching, solvent extraction, electrowinning	Copper residue	Leaching	Raw material for copper production
<i>Source: [378, Industrial NGOs 2012]</i>				

Cross-media effects

- Use of chemicals for precipitation.
- Increase in energy use.

Technical considerations relevant to applicability

Generally applicable.

Economics

No information provided.

Driving force for implementation

Sustainability of the plant operations.

Example plants

Plant A (FI), Plant B (FR), Plant C (FI), and Plant E (NO).

Reference literature

No reference literature provided.

9.3.1.7 Energy efficiency and reduction**Description**

The techniques to consider are:

- use of oxygen-enriched air in smelting furnaces and oxygen in converters;
- heat recovery boilers in which high-pressure steam is generated from hot, SO₂-containing gases produced in the smelting and converting stages;
- use of flue-gas energy;

- heat exchangers to recover the heat from the warm gas or solution flows.

Technical description

Increasing the energy efficiency and reduction of external fuel consumption can be achieved by using techniques to recover waste heat or to reduce the energy demand.

Use of oxygen-enriched air in smelting furnaces and oxygen in converters

Smelting and converting steps: in the conventional smelting route, low-grade nickel matte is first produced. The matte obtained is converted into low-iron nickel matte in a converter. In both processing steps, oxygen enrichment is used to reach an autogenous processing point. The use of oxygen enrichment allows the melting of returns, scrap and other secondary materials, especially in the converting step. Also, as the total gas flow is lowered, the electricity consumption of the fans (process gas, ventilation, etc.) is lowered.

In direct nickel flash smelting (DON) technology, high-grade nickel matte with a low iron content is produced in the flash smelting furnace directly without subsequent converting. The dried feed mixture, oxygen-enriched process air and distribution air are mixed in the concentrate burner. The concentrate ignites and burns in the turbulent gas-solid suspension in the reaction shaft. The oxidation of concentrate feed is taken further than in the conventional process. This burning process generates a large amount of energy, causing the charge to melt. Flash smelting is an energy-efficient process since it makes use of the reaction heat of the concentrate, and therefore external fuel is only needed from time to time. The usage of oxygen enrichment in a flash smelting furnace has a significant savings effect on energy consumption and results in better pollution control. Matte produced using this process has a low iron and high nickel content. The DON process has made a separate conversion step unnecessary, which has an important positive effect in terms of the environment and the energy consumption.

Heat recovery boiler

The hot, SO₂-rich gas produced in the smelting furnace or converting vessel is conducted to the heat recovery boiler. In the waste heat boiler, gas is cooled by generating steam from which energy is recovered. The steam is used for example in the drying of concentrates and for various process heating needs, such as in autoclaves. Electricity and heat for district heating may be generated from the extra steam in the power plant.

In indirect steam coil drying, the saturated steam produced in the heat recovery boiler connected to the smelting furnace is utilised.

Use of flue-gas energy

In direct drying, the hot gas is produced by the combustion of fuel in a separate chamber. To recover the energy content of the hot gas from other process steps, anode furnace exhaust gases can be partly recycled into the dryer.

Heat exchangers to recover the heat from the warm gas or solution flows

With regards to slag cleaning, the metals in the smelting/converting slag are removed in an electric furnace as an iron-containing nickel matte. Electric furnace gases are first post-combusted and then cooled. Heat from gas cooling is removed by a heat exchanger and used for heating and drying additives or coke for the electric furnace.

Production of sulphuric acid from SO₂-containing gas produces extra energy, which is removed and utilised. Oxidation of sulphur dioxide to sulphur trioxide is an exothermic reaction. Part of the energy produced by this oxidation is transferred using a heat exchanger to intermediate water for heating other process units or is sent to a second heat exchanger for district heating.

Cooling of acid is carried out using a heat exchanger where energy is removed to intermediate water. Energy from the intermediate water moves via the second heat exchanger into a district heating line or to heat other process units.

The chlorine leach process is highly exothermic, and steam in the off-gas from the leach tanks is condensed and heat is recovered into a separate glycol circuit, which is distributed for heating offices and plant buildings.

Before recycling anolyte in the nickel tank house, the solution has to be cooled. A heat exchanger is installed to cool down the anolyte before reuse, and the heated water is distributed to other processes that consume hot water or used for cleaning purposes in other areas of the plant.

Achieved environmental benefits

- Reduction of energy consumption.
- Reduction of emissions to air (in most cases the recovered energy replaces fossil fuel).

Environmental performance and operational data

Plant A: The direct electricity consumption of the nickel smelter is 1400–1800 kWh/t of metal produced, excluding for example oxygen and pressurised air (over-the-fence consumables). The fuel oil consumption in the smelter is 300–400 kg/t of metal produced including concentrate drying, flash furnace fuel, and fuel for heating up the FSF and EF. The coke consumption in the nickel smelter is 200–250 kg/t of metal produced, including coke reductant in the slag cleaning electric furnace.

Plant C: The refinery electricity consumption is 3000–4000 kWh/t of nickel produced. Heat consumption is 7 000–9 000 kWh/t of nickel produced. Plant A's copper and nickel smelters and Plant C's refinery are operating on the same site. The plants' companies have common heat recovery systems. About 50–70 % of the heat used at the site is recovered from the different process steps.

Plant E: The refinery electricity consumption is about 5 MWh/t of nickel, copper and cobalt produced. This plant delivers 40 000–45 000 MWh/yr for district heating from the sulphuric acid plant. The exothermic chlorine leach process contributes 12 MW for heating of buildings on site. The heat exchanger used for anolyte cooling to heat cleaning water has a capacity of 40 000–50 000 MWh/yr.

Cross-media effects

No information provided.

Technical considerations relevant to applicability

Generally applicable.

Economics

No information provided.

Driving force for implementation

Sustainability of the plant operation; the techniques are ecological and economical.

Example plants

Plant A (FI), Plant C (FI), and Plant E (NO).

Reference literature

[413, Warner et al. 2007]

9.3.2 Cobalt production

9.3.2.1 Techniques to reduce emissions from a cobalt solvent extraction process

Description

The techniques to consider are as the following:

- Use of low shear pumping in the liquid-liquid contact mixer-settlers that reduces evaporation of the organic and aqueous solution. Use of low shear mixing also reduces the formation of stable emulsion precipitate wastes referred to as cruds in solvent extraction processes.
- Use of a high shear mixer.
- The mixer-settler units are sealed to prevent VOC emissions to the workplace environment.

Technical description

A hydrometallurgical solvent extraction process in which the cobalt(II) ions in the aqueous feed solution are selectively separated and concentrated from a process solution typically containing mostly nickel. Aqueous feed containing the cobalt is mixed in a liquid-liquid contactor with an organic solution containing an extraction chemical that forms an organometallic complex with the cobalt, resulting in its dissolution into the organic stream. As the cobalt extraction chemicals are typically acidic ion exchangers, acid is generated during the extraction reaction, which necessitates the control of pH with an alkaline neutralising agent, e.g. ammonia or sodium hydroxide. The cobalt-loaded organic phase will contain some co-extracted impurities since the extraction chemicals are not entirely selective to the target metal and a scrubbing step follows, where impurities are removed by mixing the organic phase with an aqueous solution typically containing cobalt. The cobalt is then stripped from the organic phase back to an aqueous solution by reversing the extraction reaction by mixing with aqueous solution at a lowered pH, which breaks up the organic complex and liberates the cobalt ions. The stripped organic solvent is then returned to the extraction stage.

Achieved environmental benefits

- Minimisation of VOC emissions to air.
- Reduced formation of solid waste.

Environmental performance and operational data

No information provided.

Cross-media effects

- Increase in energy consumption.
- Use of ammonia for neutralisation of extraction chemicals and generation of ammonium sulphate. It is necessary to make purified water for the washing and stripping stages.
- Use of acid for stripping of cobalt.

Technical considerations relevant to applicability

Separation of cobalt by solvent extraction is applied to processes treating nickel-containing raw materials that also contain cobalt. To obtain a high-purity product, zinc, iron, calcium, manganese and copper should be removed from the feed solution prior to the solvent extraction of cobalt. A chemical neutralisation step is used to adjust pH levels in the extraction and washing stages. Cobalt is recovered as a highly concentrated, high-purity solution suitable as a feed for cobalt electrowinning for example.

Economics

No information provided.

Driving force for implementation

- Selective cobalt separation yielding a high-purity product.
- Low energy and chemical consumption.
- Low waste generation.

Example plants

Norilsk Nickel Harjavalta (FI), OMG Kokkola Chemicals (FI), Murrin Murrin (Australia), Kasese Cobalt Company (Uganda), Knightsbridge Cobalt (South Africa), and Anglo Platinum Rustenburg Base Metals Refinery (South Africa).

Reference literature

[414, Peek et al. 2009]

9.3.2.2 Techniques to reduce emissions from mixed hydroxide and mixed sulphide precipitation

Description

The techniques to consider are:

- use of confined process equipment when deemed necessary (reactors, settlers, filters);
- use of confined liquid and slurry transport systems (pipes and covered launders);
- use of high-efficiency solids separation and washing systems to avoid excess usage of washing water;
- use of high-grade hydrogen sulphide gas or other precipitation media to avoid large gas volumes and to enhance the performance of the precipitation process;
- use of abatement equipment (bag filters, wet scrubbers, etc.) for off-gas treatment;
- recycling the abatement residues and effluents;
- use of online monitoring and control for critical leaching and abatement equipment parameters or another equivalent suitable monitoring method or standard operating procedure;
- use of online monitoring and control of critical process parameters (e.g. reagent utilisation rate) to avoid excess chemical consumption and ensure efficient metal recovery.

Technical description

Mixed hydroxide (MHP) and mixed sulphide (MSP) processes consist of the following steps:

Mixed hydroxide process:

- MHP precipitation is carried out in an atmospheric reactor by adding a basic chemical, e.g. sodium hydroxide.
- Precipitation control is based on the pH in the precipitation reactor and consequently on the metal concentration in the exiting solution.
- Slurry from the precipitation reactor is thickened and some of the thickened solids are recycled to the precipitation step to act as seeds for further precipitation. Most of the thickened solids are further treated in the filtration step.
- Precipitated solids are separated from the thickener underflow by filtration and the filter cake is washed with water if necessary.
- Prior to shipment, the solids produced are dried (if required) and packed appropriately.

Mixed sulphide process:

- Pre-neutralisation of MSP feed solution may be required.
- MSP precipitation is carried out in an atmospheric reactor by adding a sulphide source such as hydrogen sulphide. Precipitation reactor slurry needs to be neutralised to knock out the sulphuric acid, which is generated in the sulphide precipitation reaction.

- Precipitation control is based on the pH in the precipitation reactor and consequently on the metal concentration in the exiting solution; pH control is essential to avoid hydrogen sulphide gas generation in the gas phase.
- Slurry from the precipitation reactor is thickened and some of the thickened solids are recycled to the precipitation step to act as seeds for further precipitation. Seed recycling increases the precipitate particle size and improves solids' separation characteristics thus reducing washing water consumption. Most of the thickened solids are further treated in the filtration step.
- Precipitated solids are separated from the thickener underflow by filtration and the filter cake is washed with water if necessary.
- Depending on the utilisation of the mother liquor, an additional aeration step may be required to destroy any residual free hydrogen sulphide in the liquor.
- Prior to shipment, the solids produced are dried (if required) and packed appropriately.

In sulphide precipitation processes, ventilation gases from the equipment are scrubbed in an alkaline wet scrubber. On-line or other adequate measurement and control of the most important process parameters (temperature, pH, metal concentrations) are carried out to secure safe and reliable operational results (minimum gaseous emissions, good recovery of valuable components and high precipitate quality).

Achieved environmental benefits

- Prevention or reduction of dust, metals and other compounds emissions.
- More efficient recovery of nickel and cobalt.

Environmental performance and operational data

Table 9.33: Emissions of the Kokkola cobalt plant

Process	kg Co/t of metal	kg Ni/t of metal	kg VOC/t of metal	kg H ₂ S/t of metal
Grinding/leaching	0.1	NR	NR	2
Solvent extraction	NR	NR	2	NR
Final recovery or transformation	NA	0.0.81	NR	NR
Total cobalt production	0.9	0.1	4	2

NB: Production: 10 000 t Co/yr.
NA = Not available. NR = Not relevant.

Cross-media effects

Increase in energy consumption when using wet gas scrubbers.

Technical considerations relevant to applicability

Generally applicable.

Economics

No information provided.

Driving force for implementation

- Reduction of emissions.
- Raw material savings.

Example plant

Kokkola (FI).

Reference literature

No reference literature provided.

9.3.2.3 Techniques to reduce emissions from electrowinning

Description

The technique to consider for sulphate-based processes is the covering of cells using hollow plastic spheres or polystyrene beads to prevent the release of aerosols to air.

The techniques to consider for chloride-based processes are the collection and reuse of chlorine gas in the leaching process and the use of a dimensionally stable anode (DSA).

Technical description

In sulphate-based solutions, the main anode reaction generates oxygen bubbles, which may carry sulphuric acid aerosols into the ambient air (acid mist). Depending on the plant, the air-electrolyte interface is physically blocked using hollow plastic spheres or polystyrene beads.

The cathodes in the sulphate-based process are usually made of stainless steel, and a gelatine dip is often used as the 'releasing agent' to help stripping. At the opposite end, some impurities can cause self-stripping. To overcome this risk, plants produce smaller rounds instead of plates, using marked or patterned cathodes. The most commonly used anode material is lead alloyed with antimony.

In chloride-based solutions, chlorine gas is generated at the anode. An electrolyte-permeable diaphragm cloth anode bag is used to encapsulate the anode, and a chlorine gas extraction arrangement is typically used to remove (and recover) the chlorine from the top of the bag for use in the leaching process.

In a chloride-based process, cathodes can be made of titanium, or cobalt starter sheets that have been grown on titanium mother blanks. The anode material is coated titanium (they are usually referred to as dimensionally stable anodes). Typically, the coating contains RuO_2 as the catalytic component.

Achieved environmental benefits

Prevention of diffuse sulphuric acid mist or chlorine gas emissions.

Environmental performance and operational data

The only plant electrowinning cobalt in Europe is Plant E in Norway (it produced 3208 tonnes of cobalt cathode in 2010). It is one of only two plants in the world (together with Sumitomo, Japan) using the chloride-based process.

Cross-media effects

Increase in energy use (to remove the acid mist from the cell, in the case of sulphate solutions, and to operate the chlorine removal, in the case of chloride solutions).

Technical considerations relevant to applicability

No information provided.

Example plant

Plant E (NO).

Reference literature

No reference literature provided.

9.4 Emerging techniques

Various developments have been reported for the use of low-pressure and atmospheric leaching for the production of nickel from sulphidic ores. The main processes are as follows: [139, Riekkola-Vanhanen, M. 1999]

- Activox leaching: fine grinding and leaching at 100 °C and 10 bar.
- CESL process: chloride leaching in sulphate solution using ferric chloride. The processes have been proven at the pilot stage.
- A hydrometallurgical process has been developed and patented to produce nickel and cobalt compounds from both limonite and saprolite ores for the Eramet Weda Bay Nickel project in Indonesia. The process has been designed to specifically accommodate nickel lateritic ore with a medium to high saprolite ratio. The system is able to process a composite mix of the different lithological horizons that optimise the recovery of the ore body and thus significantly reduce the production of waste material. Over 35 campaigns (more than 86 weeks) of continuous industrial pilot tests (producing good results) have been carried out by R&D incorporating environmental performance into the industrial process since 2005. Optimisation of the integrated environmental performance is the final step before the full industrial scale start-up of the Weda Bay Nickel project. The hydrometallurgical process operates in a sulphuric acid medium at atmospheric pressure and at approximately 100 °C. Heat from the sulphuric acid production units is harnessed to produce steam, which will significantly reduce the use of fossil fuels for energy production. Greenhouse gases produced by the overall process are estimated to be approximately 5.8 t/t of nickel. Iron- and manganese-based solid residues will be generated by the process. Both these residues are classified as safe for the environment. They will be separately stockpiled in dedicated and specifically designed dewatered residue stockpiles. Liquid effluents will be neutralised and passed through on-site sand filters. The precipitates generated from effluent treatment will be entirely recycled in the hydrometallurgical process [139, Riekkola-Vanhanen, M. 1999]
- Three new plants are under construction or are at the commissioning stage for the pressure leaching of laterites using sulphuric acid [139, Riekkola-Vanhanen, M. 1999] The processes are similar to the established Moa Bay process in Cuba but different purification stages are used to remove other metals. An atmospheric chloride leaching process for laterites is also being developed
- A process is being commissioned in Germany to recover nickel and zinc from residues using an oxy-fuel furnace and a solvent extraction refining system from sulphate solutions. No data have been reported.

9.4.1 Thermal decomposition of nickel complexes

Description

Production of nickel powder under an inert atmosphere in an electric furnace from the spent electrolytic bleed from the electrolytic refining of low-purity copper anode.

Technical description

Metallo-Chimique produces nickel using the following process.

Nickel is recovered from the nickel-enriched solution of the electrolysis, by precipitation. Nickel (complex) precipitation is carried out by adding an organic complexing agent to the bleed solution of nickel sulphate in a closed reactor vessel. The solution is obtained from the

electrolytic refining of low-purity copper anodes during copper cathode manufacturing. The insoluble nickel complex is separated by filtration.

The thermal decomposition of nickel complexes into finely divided powders is carried out under an inert atmosphere in an electric furnace. The result is a nickel powder, which is cooled and transferred by a conveyor to a powder press for briquetting. The resulting briquettes are fed into big bags.

To reduce emissions, a two-step NaOH scrubber is installed. It has a capacity of 7500 m³/h. The scrubber treats the air coming from the reactor vessels and the electric furnace.

Achieved environmental benefits

- Recovery of nickel metal.
- Reduction of emissions.

Environmental performances and operational data

The operational data of the scrubber, based on spot sample measurements during 2011–2012 show the flow was 1500–7500 Nm³/h, and the dust emissions were 0.7–2.5 mg/Nm³.

Cross-media effects

- Increase in investment cost (due to additional equipment to be installed).
- Increase in energy consumption.
- Increase in operational cost due to the use of additives.
- Requirement to treat water stream in an appropriate way.

Technical considerations to applicability

No information provided.

Economics

The cost of installing the scrubber is approximately EUR 100 000.

Driving force for implementation

- Reduction of emissions.
- Raw material savings.
- Stringent emissions standards and other regulatory requirements.

Example plant

Metallo-Chimique (BE).

Reference literature

[415, Nickel Institute 2013]

10 PROCESSES TO PRODUCE CARBON AND GRAPHITE ELECTRODES, CATHODES AND SHAPES

10.1 Applied processes and techniques

There are a number of processes that are used to produce a wide range of carbon and graphite products. Carbon or graphite electrodes and furnace linings are produced for a variety of production processes, in particular, primary aluminium smelting, and ferro-alloy and steel production. This chapter covers the production of carbon and graphite electrodes, cathodes and shapes not intended for use in aluminium production.

All of the processes use coke, anthracite, graphite and other raw materials such as pitch to produce pastes, electrodes and shapes.

Traditionally, the sector divides its process steps into:

- supply, storage, preparation, mixing and shaping (the so-called green department);
- baking, impregnation and rebaking (also known as the baking plant);
- graphitisation;
- machining;
- packing and dispatch.

The main product types and process stages are shown in Table 10.1 and Figure 10.1.

Table 10.1: Overview of materials and process steps for carbon and graphite products

Input materials	Process	Products
Anthracite coal Uncalcined coke	Calcining	Calcined anthracite Coal Coke
Calcined anthracite coal Coke Graphite Pitch, additives, resins (solids)	Storage, handling, grinding, sieving	
Pitch, additives, resins (liquids)	Storage, handling	
Calcined anthracite coal Coke Graphite Pitch, additives, resins (solids and liquids)	Mixing	Paste
Paste and green powder	Shaping	Green shapes and green powder
Green shapes	Baking	Baked shapes
Baked shapes Graphite shapes Pitch, additives, resins	Impregnation	Impregnated shapes
Impregnated shapes	Rebaking	Rebaked shapes
Baked or rebaked shapes	Graphitising	Graphite shapes
Baked and graphitised shapes	Machining	Graphite and carbon components
<i>Source: [116, VDI 1998].</i>		

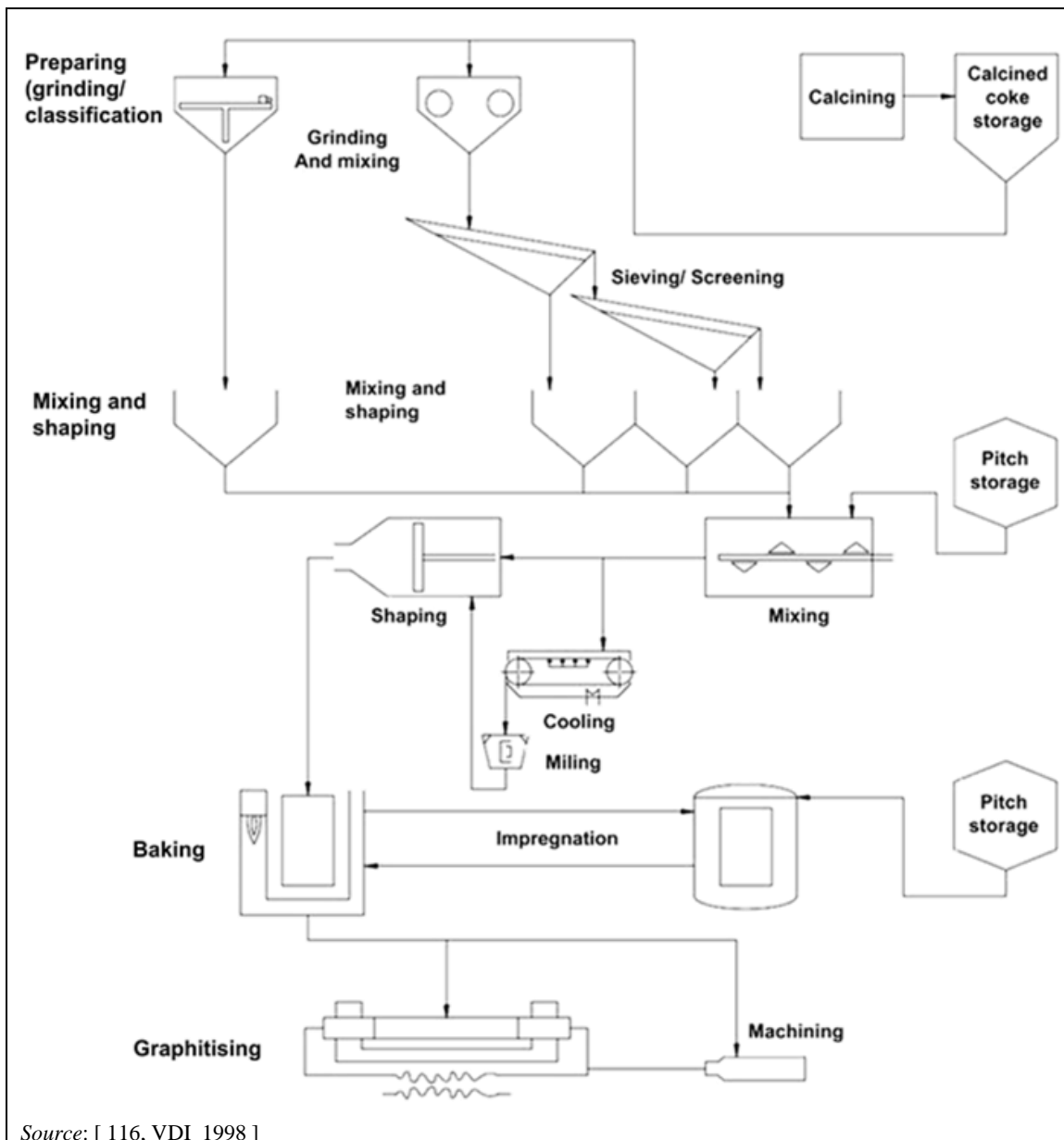

Source: [116, VDI 1998]

Figure 10.1: Overview of carbon and graphite production

10.1.1 Processes to produce calcined materials

Calcining is a heat treatment process used to remove moisture and volatiles from a raw material. Suitable materials for calcining include uncalcined coal (e.g. anthracite) and coke (e.g. pitch coke, metallurgical coke and petroleum coke). These raw materials are supplied at the top of the furnace, with the flow through the furnace controlled by the rate of discharge at the bottom of the furnace. Moisture, sulphur and volatiles are released during this process.

There are two types of calcining process: the electrical calcining furnace process and the gas calciner process.

An electrical calcining furnace applies electrical power for heating. The necessary electrical current is supplied either to the furnace through one carbon electrode positioned in the top of the furnace and one carbon electrode in the bottom, or through two graphite electrodes positioned in the top of the furnace and one carbon furnace lining in the bottom. The material in the furnace will reach temperatures in the range of 1200–3000 °C. Ash components in the carbonaceous material are volatilised in the hottest areas of the furnace and radially transferred outwards,

where they condense on cooler material or the furnace lining. The ash components will finally be withdrawn together with the calcined material at the bottom of the furnace. All gases generated are burnt off from the top of the furnace.

A gas calciner uses all released volatiles from the calcining process as fuel material to reach the required temperature for the heat treatment. The temperature range is 1200–1350 °C.

In both cases, the flaring of the aforementioned off-gases generates emissions of H₂O, CO₂, NO_x and SO_x. The calcined materials are normally used as raw material in green paste. They can also be used as carbon raiser for steel production and cast iron.

10.1.2 Processes to produce paste, green powders and green shapes

Green paste production is the starting point for the production of all carbon and graphite products. All green pastes are manufactured from a mixture of different types of calcined coke and coal, with up to 40 % pitch, which acts as a binder. For speciality graphite products, resins can also be used as a binder. Other additives such as sulphur and metals can be added to the blend of raw materials to give the desired physical properties to speciality graphite products.

Depending on the origin of cokes, they can contain substances such as metals (e.g. nickel) and sulphur compounds. Highly annealed metallurgical and lignite cokes are used as auxiliaries for packing. Calcined and annealed cokes by themselves are free of hydrocarbons and PAH.

Solid raw materials are normally transferred by sealed conveyor or dense phase pneumatic systems and are stored in silos. Liquid pitch is transported in the molten state and is transferred by pumping and is stored in heated tanks. The tank ventilation gases contain hydrocarbon fumes and are usually cleaned. Afterburners, condensers or scrubbers and back-venting of the tank gases are used.

Raw materials are mechanically prepared (grinding, milling, sieving) and are mixed in heated mixers. The ratio of pitch in the mixture is adjusted according to the application and to allow the paste to be handled.

The preparation and mixing stages are important, as there are a wide variety of graphite products and specifications and the characteristics of these products often depend on a particular grain size. The choice of grinding or milling technique is made according to the carbon particle size required for a particular product.

Raw materials are mixed to produce a constant feed and weighing systems are used to prepare a particular recipe depending on the product. A variety of mixers are used depending on the product required, the particle size of the raw material and the throughput required. Heated mixers and screw conveyors (typically at 200 °C) are used to prevent batches from solidifying and to allow the efficient discharge of the contents. Kneading mixers, paddle mixers and continuous action mixers are used. Continuous or batch operation is practised and can depend on the scale of the operation.

The green mixture is passed to a shaping process to produce the shapes required. Moulding, extrusion and vibrating systems are used. During special carbon production, green shapes may be washed with alcohol to remove excess resin. Large shapes may also be cooled in a closed circuit water bath.

In the case of Søderberg paste, the blend is produced in a way that allows it to be added to the electrode shell. Søderberg paste is normally used for electrodes in the primary aluminium industry, but the paste can also be made into electrodes by pressing and forming for use in other applications, for example in electric furnaces for the production of ferro-alloys. Søderberg electrodes are also produced from the paste by a forming process. In this case, the green electrodes are formed into the required size and shape [75, Nordheim, E. 1998]. These

electrodes are commonly used in submerged electric arc furnaces. A number of variants exist, for example hollow electrodes can be made to allow furnace feeding through the electrode, and composite electrodes can be made to overcome production problems.

Raw material storage and handling stages use enclosed delivery and handling systems and integrated dust filters. Liquid pitch delivery and storage systems use tank back-venting and condensers for tank breathing during storage. Solid pitch is delivered in bulk in closed containers or in closed big bags.

Dust from handling and mechanical processes is collected in bag filters. Gases from all of the processing stages are collected and treated by different kinds of abatement systems such as afterburners (TOs or RTOs), wet or dry scrubbers, ESPs or combinations of systems. Solvents from the washing stages of special carbon production are collected, extracted and reused if possible or removed in biofilters.

10.1.3 Processes to produce baked shapes

During the baking process, in which the green shapes are baked, the pitch is converted into pitch coke, making the material electrically conductive. Green shapes are baked at temperatures from 700 °C to 1300 °C in the absence of air. The baking process can take up to 28 days. This thermal process results in the shapes losing up to 20 % of their weight.

Multi-chamber furnaces (like closed or open ring furnaces) and single chamber furnaces (like car bottom or pit furnaces) are used for the baking stage.

Ring furnaces consist of a large number of pits, which contain the green shapes. Refractory brick walls separate the pits, and ducts are created for the flue-gases. Green shapes are stacked in the baking furnace in rows and the heating ducts are created. Layers of packing coke separate the parts and prevent oxidation. This coke is consumed during the heating and cooling cycle at a rate of up to 14 kg per tonne of green material, and the remaining coke is reused. At any one time, pits in separate sections of the furnace are being filled, heated, cooled or emptied. [91, OSPARCOM 1992]

Hot air is passed through the ducts using movable gas-fired burners and the shapes are baked. The ducts are kept under negative pressure to contain the fumes. At the end of the heating cycle, the ducts are connected to blowers to cool the section. Hot air passing from the furnace section being cooled is then recycled through the burners or through other furnace sections to preheat that part of the system. [116, VDI 1998].

Two main types of ring furnace are used for baking: open and closed. Open furnaces use a horizontal duct and closed furnaces use a vertical flue. The horizontal ducts of the open furnace are separate and parallel, which allows the heating cycle to be optimised for each duct and so reduces fuel consumption [91, OSPARCOM 1992]. A typical open furnace layout is shown in Figure 10.2.

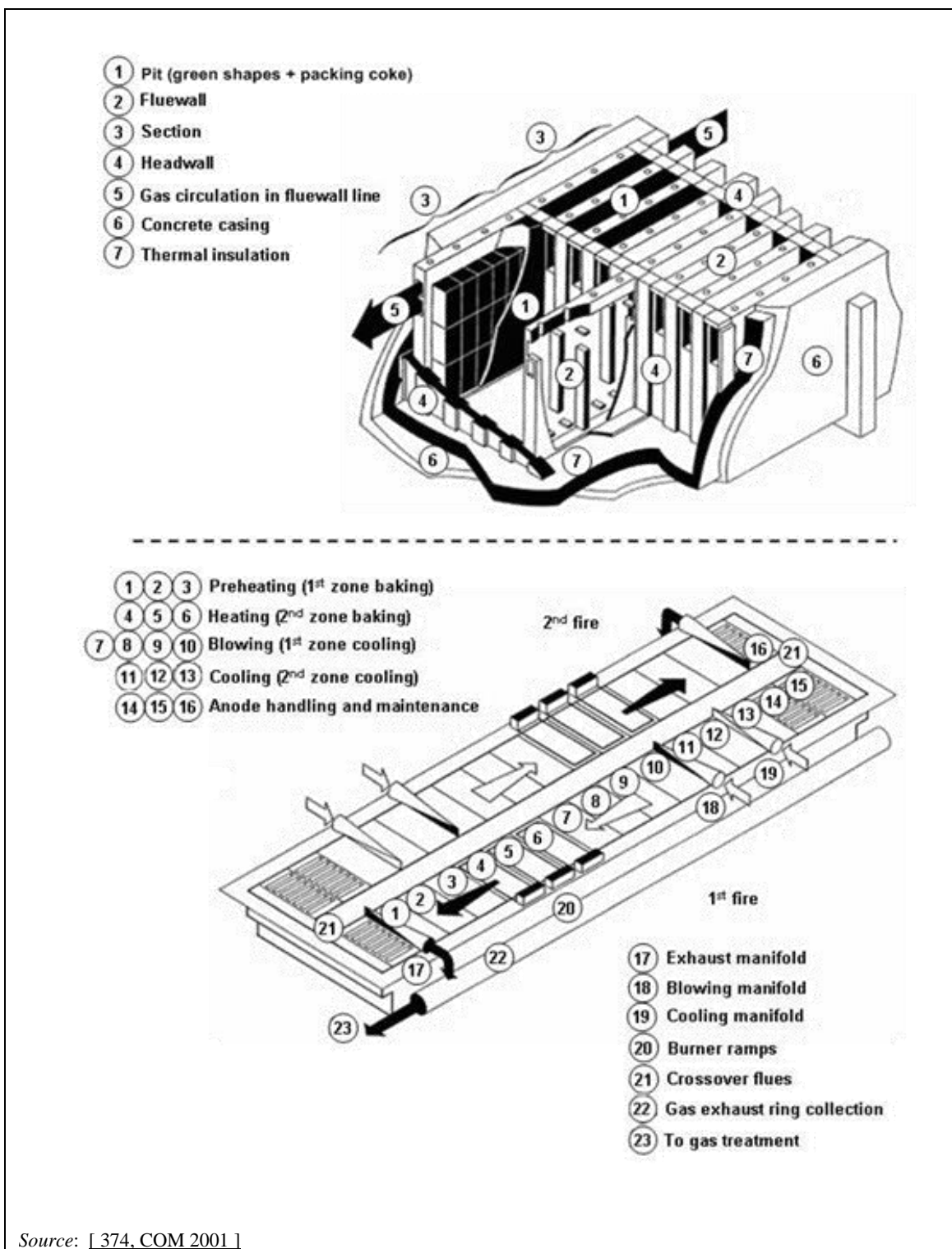

Figure 10.2: General view of a multi-chamber furnace (open ring furnace)

The use of multiple chambers in the furnace allows heat from one section to be used in other sections.

The car bottom furnace is a single chamber furnace. In the car bottom concept, the car (which is the furnace bed or bottom) is constructed as a mobile platform mounted on railroad wheels. It can be removed from the furnace and transferred to loading or unloading areas.

The car bottom furnace consists of a steel shell that is built above ground and lined with refractory thermal insulation. The entrance end of the furnace is closed by means of a vertical

travel door that seals to the two sides and to the roof when in the downward/closed position. The car is sealed to the three walls of the shell and to the door by means of a water trough (on the car) and seal blades (on the shell). Fans mounted in the roof move air from the top of the furnace to the bed, spreading the heat from top to bottom.

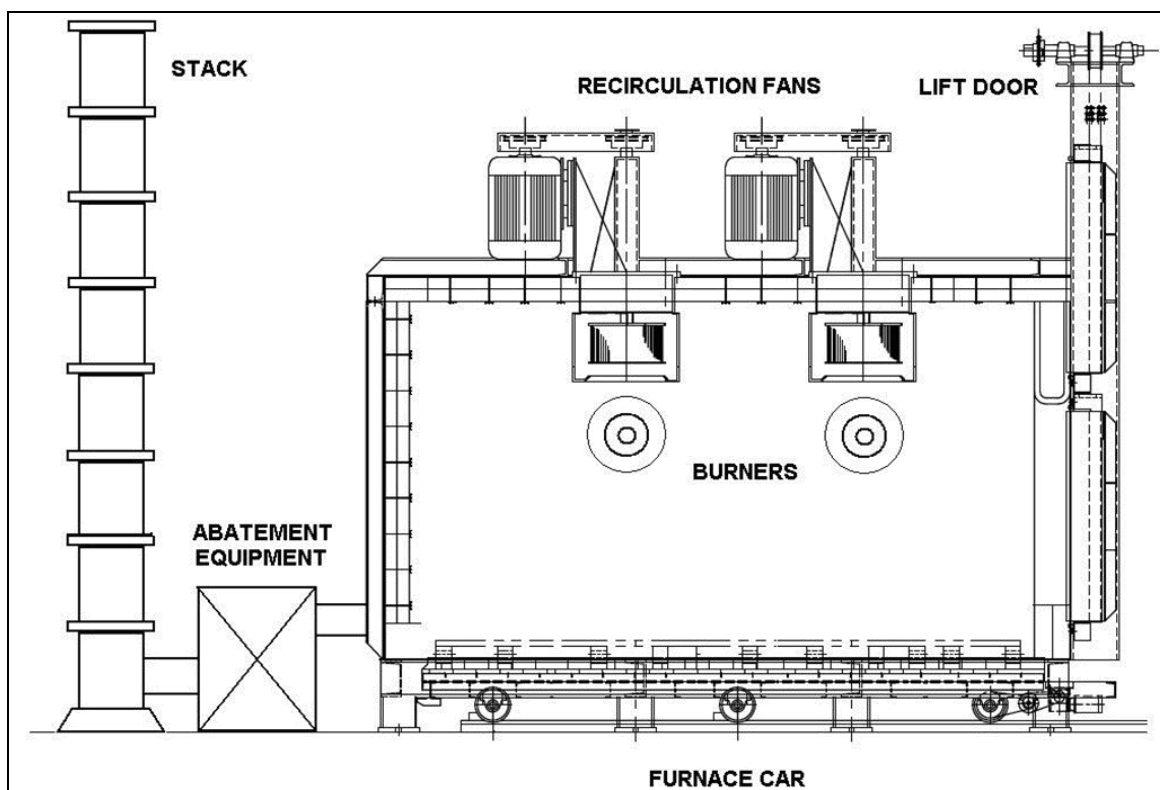

Figure 10.3: General view of a single chamber furnace (car bottom furnace)

In a loading station, the green shapes are introduced into a cylindrical canister called a sagger and filled with packing material to avoid the deformation of the shapes during the heating process. Then, the loaded saggars are placed on the furnace car for transportation to the furnace. Once the car bottom furnace is loaded and the door is closed, the heating cycle starts.

The car bottom furnace can also be used for baking without any packing material. Then the green or impregnated shapes are stacked in either vertical or horizontal frames.

The cycle used for the baking operation consists of different steps and may vary depending on the furnace characteristics, product size and binder content. The hot air coming from the furnace chamber during the baking process is transferred to the stack after treatment. The characteristics of the hot air depend on the heating cycle step in which it is generated.

After the baking cycle is finished, the door is opened and the car is taken out of the furnace and transported to an unloading station, where the shapes are extracted from the canisters. The packing material contained in the saggars is reused.

Tunnel furnaces are used for the small-scale production of speciality carbon. The tunnel furnace is fed with preshaped forms that are carried through the fired zone in a sagger filled with packing material. The furnace is usually gas- or oil-fired and a recuperator is usually incorporated to preheat fuel or combustion air.

10.1.4 Processes to produce impregnated shapes

Impregnation is an optional stage carried out in order to improve the properties of the final product.

Pitches, resins, molten metals and other reagents can be added to the baked shapes (in special applications, graphite shapes can also be impregnated) and are used to fill the voids formed in the carbonised material. Soaking with hot coal tar pitch with or without vacuum and autoclaving are used. Various impregnating techniques are used depending on the product, such as batch or quasi-continuous operations. The impregnation cycle usually involves preheating the shapes, impregnation and cooling. A hardening reactor may also be used. Electrodes that are to be impregnated can be preheated by the waste heat of the thermal oxidiser.

Only speciality carbons are impregnated with various metals.

10.1.5 Processes to produce rebaked shapes from impregnated shapes

Rebaking is only used for impregnated shapes.

Impregnated shapes are rebaked at temperatures of up to 1300 °C using a variety of furnaces such as tunnel, single chamber, multiple chamber, annular and push rod furnaces depending on the size and complexity of the product. Continuous baking is also carried out. The furnace operations are similar to those used for the shapes baking process, but the furnaces are usually smaller.

10.1.6 Processes to produce graphitised shapes

Baked or rebaked shapes may then be subject to graphitisation.

Graphite is manufactured by the conversion of baked carbonaceous material to graphite, in a process called graphitising, which is a heat treatment of the material at temperatures from 2200 °C up to 3300 °C. During the graphitising process, the more or less preordered carbonaceous material is converted into a three-dimensionally ordered graphite structure. There are two types of furnace common in industrial use, depending on the sizes or shapes of the products and the raw material used. Graphitising is carried out in Acheson or Castner furnaces.

Both furnaces are electric resistance furnaces constructed from refractory material. They differ in the way the current is applied to the furnace. In the Acheson furnace, shapes are placed inside the furnace body and the interstices filled with a coke-graphite mixture (resistor packing), and current is passed through the resistor packing and the shapes. In the Castner furnace, the shapes form the entire current path and lead to gains in the current efficiency.

Other specialised furnaces are also used, like tunnel furnaces, induction furnaces or vacuum graphitising furnaces for speciality products.

Castner and Acheson furnaces are shown in Figure 10.4 and Figure 10.5.

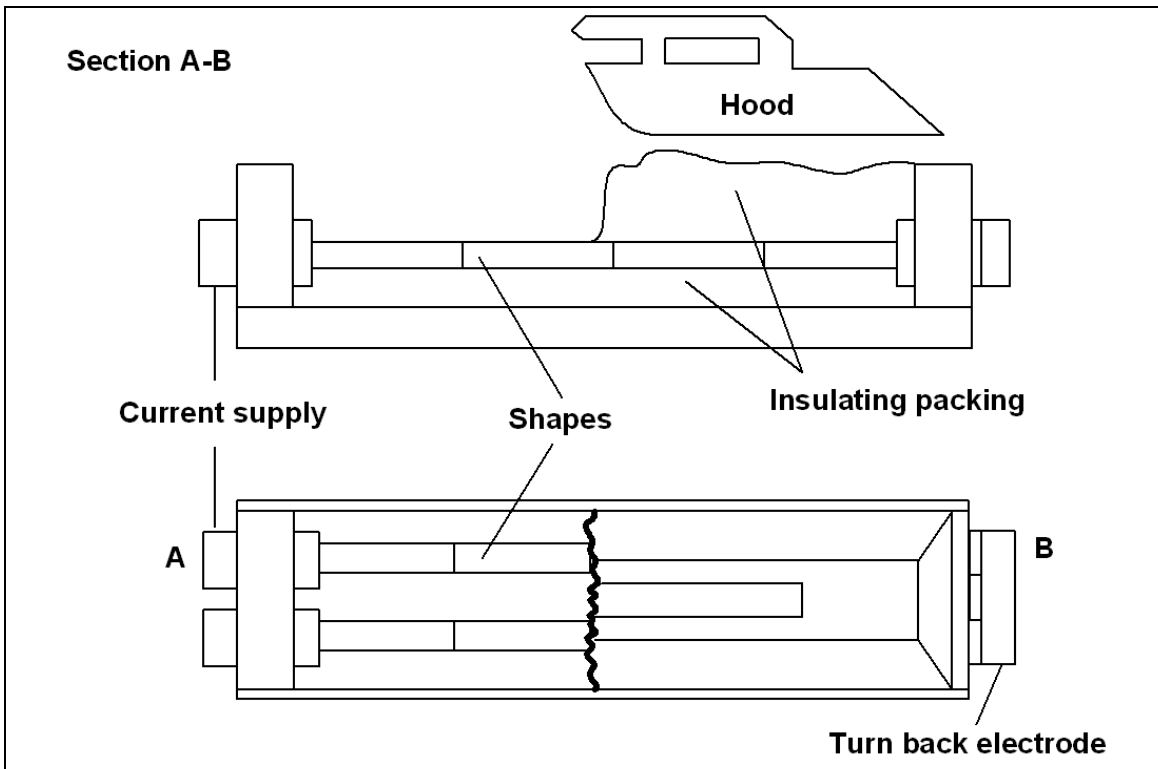

Figure 10.4: Castner graphitising furnace

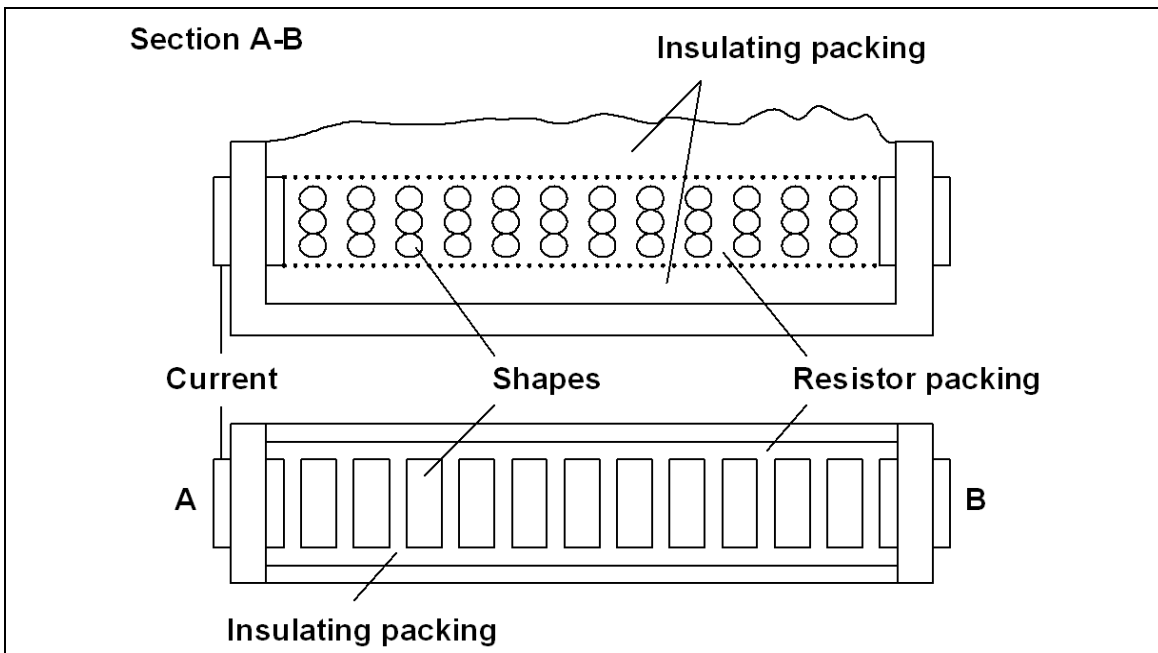

Figure 10.5: Acheson graphitising furnace

In some cases, no hoods are used where there are only minor diffuse dust emissions and the carbon oxides are well dispersed at the roofline.

The Acheson furnace is used for baked or rebaked shapes with irregular dimensions and cross-sections. The furnace charge is arranged in blocks within a horizontal bed, usually perpendicular to the axis of the furnace. The space between these segments is filled with a resistor material consisting of silicon carbide, coke, sawdust and sand mixture. The current is supplied to the firing charge by two water-cooled head electrodes at the narrow sides of the furnace. The

furnace charge is thermally insulated by a mixture of coke, sand, carbon black and/or sawdust, thus protecting the carbonaceous material against oxidation. As the electrical resistance of the furnace decreases with an increasing degree of graphitisation, the power to the head electrodes is controlled and adjusted by transformers. Depending on the size of the furnace and its operation mode, one working cycle including cooling lasts two to six weeks.

The Castner furnace is used for shapes with parallel faces and equal cross-sections. Lengthwise graphitisation (longitudinal array) is characterised by the direct connection of one furnace charge to another in a row without a resistor material in between. The insulation against oxidation and high heat losses is achieved by packing material consisting of coke and graphite. The prebaked carbonaceous electrodes are clamped between the head electrodes of the furnace and heated by passing the current directly through the load. Heating cycles vary from several hours to several days and the cooling cycle takes up to 14 days.

10.1.7 Processes to produce machine baked, rebaked or graphitised products

Sawing, turning, drilling, milling and similar mechanical processes are used to prepare the baked, rebaked and graphitised shapes according to the requirements of the customer. The surfaces of the final shapes are treated according to the final use. After the mechanical completion, surface coating measures to reduce negative burnout effects at the final destination may be applied. Powders, particles or dust produced by these processes are collected, extracted and stored in silos, bags or closed containers, and reused or recycled as far as possible.

10.1.8 Processes to produce speciality carbon and graphite products

Other graphite products such as seals, brushes, crucibles and comparable products are produced in a similar way to graphite electrodes. There are differences in the size and complexity of the products and this affects the processes that are used. Other additives such as sulphur and metals can be added to the blend of raw materials to give the desired physical properties to the product. Sometimes resins are used instead of pitch.

Porous graphite is also produced in the basic process by blending sawdust with the raw materials. During baking, the sawdust is combusted and a porous matrix of carbon or graphite remains.

High-purity graphite is produced in a similar way, but the graphitising process is used to remove impurities such as metals. In this case, chlorine or Freons are used in the gas stream and they decompose to produce chlorine and fluorine, which react with metallic impurities to form volatile salts therefore removing the metals from the graphite. Current practice includes the use of Freons that are recovered from appliances, and the process therefore provides a useful method for dealing with these materials. Excess halogens and metal salts are removed from the off-gas by dry or wet scrubbing.

Speciality products such as carbon fibre-reinforced carbon, carbon fibres and carbon fabrics are also made, and an induction or pit furnace is used. The processes used to produce carbon fibres and associated materials can include acrylonitrile as a precursor in the form of polyacrylonitrile cloth (PAN cloth) or as an impregnating agent [128, Davies, N. 1998]. In these cases, hydrogen and sodium cyanides can be produced during the heating stages in the furnace. Sodium cyanide can be converted at high temperatures in the presence of carbon oxides to sodium carbonate. An afterburner is used to oxidise the gases emitted.

10.2 Current emission and consumption levels

The potential emissions points of the various process stages are shown in Figure 10.6.

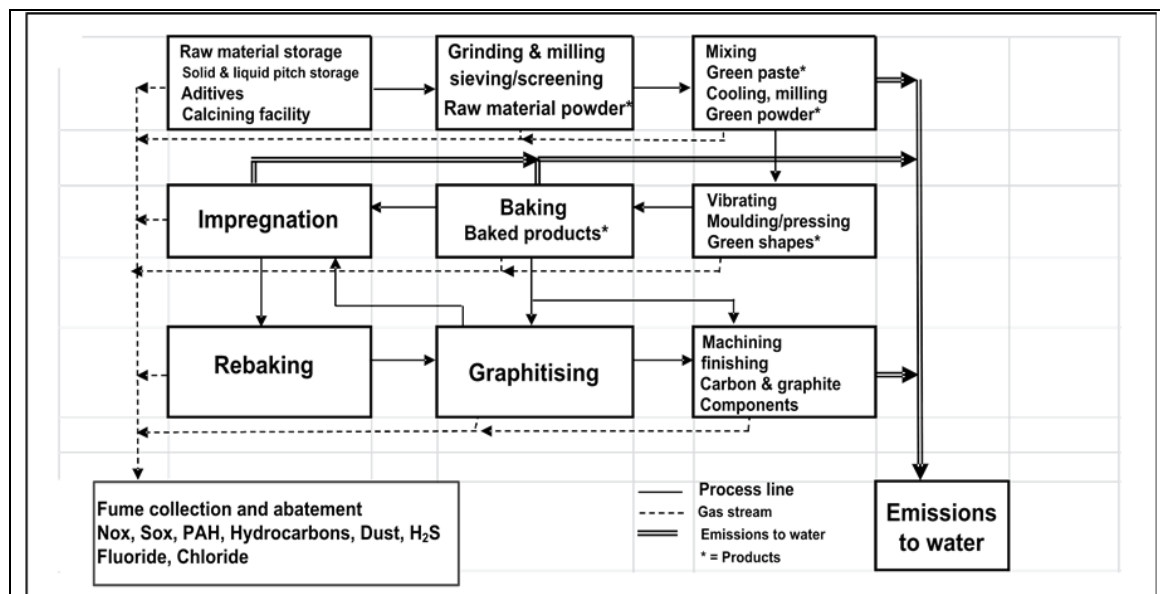

Figure 10.6: Generic emission diagram of the carbon and graphite production processes

Energy use in baking is up to 11 GJ/t (including the abatement equipment's energy consumption; furnaces are usually fired with gas or oil), and in graphitising it is 9–20 GJ/t.

10.2.1 Emissions to air

The emissions can escape the process either as stack emissions or as diffuse emissions depending on the age of the plant and the techniques used. Stack emissions are normally monitored continuously or periodically depending on the component measured and reported by on-site staff or off-site consultants to the competent authorities.

There are potential emissions to air of hydrocarbons (such as PAH), sulphur dioxide, dust, and cyanide (only for fibre production from acrylonitrile). The formation of SO₂ is influenced by the fuel, raw materials and other additives used, whereas the formation of NO_x is determined by the combustion temperature.

In carbon and graphite processes, a combination of techniques such as afterburners, electrostatic precipitators, scrubbers and bag filters is used. Dust from handling and mechanical processes is collected in bag filters. Solvents from the washing stages of special carbon production are collected and reused if possible or removed in biofilters.

The removal of PAH by adsorption onto coke is temperature-dependent. At higher temperatures, the lighter substances will not adsorb. Modern prebake furnaces have a more complete combustion. The old technique of indirect cooling prior to dry scrubbing cannot be used, since the deposit is no longer a free-flowing tar but a sticky powder. Packing coke is consumed at a rate of ~ 12–18 kg per tonne of electrodes [116, VDI 1998].

Coke filters can be used, but it is concluded that the tar fraction that is emitted by the baking process is the light condensable fraction. This may not be fully carbonised during the subsequent early stages.

There is therefore a distinct possibility that not all of the condensable fraction will be collected if only absorption onto coke is used for the baking stages. A significant portion of the tars can be recycled from the coke filter material during the temperature increase of the preheating stage of the baking furnace.

Besides coke filters, the removal of PAH in carbon and graphite processes is also possible by using a combination of techniques such as afterburners, regenerative thermal oxidisers, dry or wet scrubbers, bag filters and electrostatic precipitators.

There are also differences in the emissions characteristics depending on whether open or closed baking furnaces are used. In some cases (depending on the baking process and on the manufactured products), in open furnaces more volatile hydrocarbons are burnt within the furnace.

10.2.1.1 Polycyclic aromatic hydrocarbons

Carbon and graphite paste and shapes are produced from different cokes and pitches. Emissions of hydrocarbons and PAH can occur during storage, handling and transport of pitch, mixing and shaping, baking and impregnation. PAH are potentially hazardous to the environment as well as inside industrial plants and this is an important issue within the carbon and graphite industry. The raw gas characteristics are reported in [318, Hagen et al. 2007].

PAH values are subject to some uncertainty. Several standardised methods exist to measure and report PAH and the following groups have been used for this report: VDI-group I (2 compounds), VDI-group II (7 compounds), VDI-group I+II (9 compounds), OSPAR 11 (11 compounds), EPA (16 compounds) and Norwegian Standard NS 9815 (16 compounds).

The PAH compounds measured and reported for these conventions are shown in Table 10.2.

Table 10.2: Reporting conventions for PAH

PAH compounds	PRTR	VDI-I	VDI-II	VDI-I+II	OSPAR II	EPA	Norw. Std (NS 9815)
Naphthalene	X					X	
Acenaphthylene						X	
Acenaphthene						X	
Fluorene						X	
Phenanthrene					X	X	X
Anthracene	X				X	X	X
Fluoranthene					X	X	X
Pyrene						X	X
Benzo(a)pyrene	X	X		X	X	X	X
Dibenzo(a,h)anthracene		X		X	X	X	X
Benzo(a)anthracene			X	X	X	X	X
Benzo(b)fluoranthene	X		X	X	X	X	X
Benzo(j)fluoranthene			X	X			
Benzo(k)fluoranthene	X		X	X	X	X	X
Chrysene			X	X	X	X	X
Indeno(1,2,3-cd)pyrene	X		X	X	X	X	X
Benzo(ghi)perylene					X	X	X
Benzo(b)naphtho(2,1-d)thiophene			X	X			
Benzo(a)fluorene							X
Benzo(b)fluorene							X
Benzo(e)pyrene							X
Dibenzo(a,e)pyrene							X

NB: In the framework of the European Pollutant Release and Transfer Register (E-PRTR), established in Regulation (EC) No 166/2006, PAH are to be measured for reporting of releases to air as benzo(a)pyrene, benzo(b)fluoranthene, benzo(k)fluoranthene and indeno(1,2,3-cd)pyrene. Anthracene and naphthalene have to be reported separately.

The preferred reporting convention for PAH emissions is the EPA as this is compatible with the PRTR reporting requirements [299, COM 2007]. However, low-molecular-weight PAH are very sensitive to the sampling and testing conditions and procedures, and so there is more uncertainty in EPA data due to the possible incompleteness of their collection. It has also been established as a common practice in some countries to report BaP as an indicator of high-molecular-weight PAH.

10.2.1.2 Dust

During production, dust emissions occur during all process stages (calcining, storage, transfer, grinding, sieving, mixing, shaping, baking, graphitising and machining). The emissions are mainly caused by dust generated during the grinding, screening and shaping processes and from the carbonisation gases. Most of the production stages are enclosed and extracted [116, VDI 1998]. The source of dust and its material characteristics influence the abatement method used to remove it and its effectiveness. Bag filters are generally used.

In some cases of manufacturing special carbon and graphite products, absolute filters are used to remove dust and the cleaned air is then used in the workplace.

10.2.1.3 Combustion gases

Gases produced from the combustion of gas or fuel oil will be emitted from the process. There is potential for emissions of carbon oxides and oxides of sulphur and nitrogen. Optimisation of combustion conditions and the use of low-NO_x burners are commonly practised and the fuel choice is made according to site conditions and availability.

10.2.1.4 Sulphur dioxide

The raw materials from which the products are made contain sulphur and the fuel used for heating (oil) can also contain sulphur. This results in the emission of sulphur dioxide during the baking and calcining of coke and coal [6, McLellan and Partners Ltd 1993]. Furthermore, there are some products that require the addition of sulphur to improve their quality. This can be a significant source of sulphur dioxide and wet scrubbers are sometimes used to remove this.

10.2.1.5 VOCs (from the manufacture of special carbon and graphite products)

VOCs may be emitted during the use of resins as a binder or for impregnation. Afterburning or adsorption techniques are used to control these [116, VDI 1998]. Washing and drying stages in speciality carbon production use solvents such as ethanol. These materials are potential sources of odours and are usually removed at source. Biofilters are used to absorb and decompose the organic compounds and remove odours from the gas stream. The gas is prewetted and usually passes through a number of filters in series. The biofilters operate on a batch basis and the biological substrate (peat, twigs, etc.) is replaced periodically. VOC emissions of less than 20 mg/Nm³ are achieved.

10.2.1.6 Cyanides (polyacrylonitrile (PAN)-based carbon fibre production)

Cyanides are produced during the decomposition of acrylonitrile (in PAN cloth) used in the production of carbon fibres. HCN concentrations of 55 mg/Nm³ have been reported during periods when abatement has not been available [128, Davies, N. 1998]. Afterburners are used to decompose hydrogen cyanide.

Sodium cyanide can also be formed if sodium thiocyanate is used as a solvent for acrylonitrile. In this case, the sodium is driven off the carbon fibre during the high-temperature treatment stage and solid sodium cyanide is formed during cooling. In the presence of CO₂ at high temperatures, this is mainly converted into sodium carbonate. Cyanide emissions of less than 2–5 mg/Nm³ are achieved.

10.2.1.7 PCDD/F

Test results on emission sources and abatement units in this sector indicate that PCDD/F are not relevant for the conventional carbon and graphite manufacturing processes. This will need to be re-examined if chlorine compounds or additives are used.

10.2.1.8 Summary of the main air pollutants

The relative significance of emissions of SO₂, halides, hydrocarbons, cyanide, NO_x and dust from the processes that are used in the production of carbon and graphite are shown in Table 10.3.

Table 10.3: Relative significance of potential emissions to air from carbon and graphite production

Component	Calcining	Storage and handling	Grinding and milling	Mixing and forming	Baking	Impregnation	Graphitising	Machining
Sulphur dioxide	•• (¹)(²)	NR	NR	NR	•• (¹)(²)	NR	•• (²)	NR
Hydrocarbons including PAH	NR	••• (³) • (⁴)	•	••	•••	•••	NR	NR
Cyanide	NR	NR	NR	NR	•• (⁵)	NR	•• (⁵)	NR
Nitrogen oxides	NR	NR	NR	NR	•• (²)	NR	•• (²)	NR
Dust	•	••	•••	••	•	NR	••	•••

(¹) With raw materials that contain sulphur.
(²) Combustion gases.
(³) High concentration during loading. Solid pitch.
(⁴) High concentration during loading. Liquid pitch.
(⁵) With carbon fibres.
NB: ••• More significant – • Less significant.
NR = Not relevant.
Source: [226, Nordic Report 2008], [373, Grådahl et al. 2007]

In carbon and graphite processes, the calcining of coal and coke usually takes place without using any abatement technique. Emission ranges vary depending on the heat source (electrically calcined materials or gas-heated calcined materials), as shown in Table 10.4 and Table 10.5.

Table 10.4: Emissions from electrically calcined coke and coal

Source	Abatement type	Pollutant	Emissions range (kg/t product)
Calcining (electrical)	No abatement technique used	SO ₂	< 5
		NO _x	0.1–0.35

Table 10.5: Emissions from natural gas-calcined coke and coal

Source	Abatement type	Pollutant	Emissions range (mg/Nm ³)
Calcining (natural gas)	No abatement technique used	Dust	< 20
		SO ₂	< 150
		NO _x	< 350
		BaP	0.01

The main air pollutants and emission ranges achieved by various abatement techniques during carbon and graphite electrode production are shown in Table 10.6.

Table 10.6: Examples of emission ranges for a number of carbon and graphite production processes

Source	Abatement type	Pollutant	Concentration range (mg/Nm ³)
Material handling and storage (coke)	Cyclone	Dust	20–150
	Bag filter	Dust	1–20 (up to 30 when using truck loading filters or silo roof filters)
Material handling and storage (pitch)	Bag filter	BaP particulates	< 0.01 (for pitch containing dust)
	Re-venting, condensation	Hydrocarbons	1–75
Grinding, mixing and shaping ⁽¹⁾	Fabric filter	Dust	1–20
		Dust	9–20
		BaP	0.01–0.05
		SO ₂	< 150 (in the event of sulphur addition in the process, a wet scrubber is used)
	Regenerative thermal oxidiser	NO _x	< 100
		Dust	1–20
		BaP	0.002–0.01
	Dry scrubber followed by bag filter	NO _x	< 10
		Dust	1–20
	Baking	Bag filter	Dust
BaP			< 0.1–0.3
ESP		Dust	< 20 (for handling packing materials)
		Dust	1–40
		Hydrocarbons	2–17
		Benzene	0.15–7.5
		BaP	0.01–0.05
		SO ₂	50–330
		NO _x	< 500
Thermal oxidiser		Dust	< 20
		BaP	0.01–0.05
		SO ₂	10–90 (in the event of sulphur addition in the process, a wet scrubber is used)
		NO _x	50–70
Thermal oxidiser and wet or dry scrubber ⁽²⁾		Dust	3–20
		BaP	0.01–0.1
		SO ₂	< 90
		NO _x	< 100
Regenerative thermal oxidiser		Dust	2–20
		BaP	0.003–0.05
		SO ₂	< 100
	NO _x	< 100	
ESP and regenerative thermal oxidiser	Dust	2–20	
	BaP	< 0.05	
	SO ₂	< 200 (in the event of sulphur addition in the process, a dry scrubber is used)	
	NO _x	< 100	
Regenerative thermal oxidiser and dry scrubber	Dust	2–20	
	BaP	< 0.02	
	SO ₂	< 100	
ESP and dry scrubber	Dust	2–20	
	BaP	< 0.02	
Impregnation	Thermal oxidiser	Dust	1–200

		BaP	0.001–0.05
		Hydrocarbons	3.5–7.5
		PAH	0.0002–0.2
		Benzene	0.4–7.5
		SO ₂	100–200
		NO _x	80–200
	Dry scrubber	Dust	2–20
		BaP	0.0005–0.01
Rebaking	Thermal oxidiser	Dust	< 35
		BaP	< 0.003
		SO ₂	5–330
		NO _x	< 500
Graphitising	Bag filter	Dust	1–20
		Hydrocarbons	1–25
Machining and shaping	Bag filter	Dust	1–20
		Hydrocarbons	1–25

(¹) Due to the fact that the flow rates in the grinding, mixing and forming areas are lower than emissions arising from other processes, in many cases these off-gases are treated in the abatement systems available in other stages (e.g. baking process).
(²) Wet or dry scrubbers are used only when using special additives.
Source: [345, UBA (D) 2009], [381, ECGA 2012]

In a RTO, the different PAH are not destroyed to the same extent; higher molecular PAH are more difficult to remove. The 16 substances normally reported belong to different classes of pollutants in terms of toxicity.

Table 10.7 shows the rate of destruction of some PAH in a RTO and the effect of pretreatment.

Table 10.7: Rate of destruction of some PAH in a RTO

Parameter	Unit	Upstream of pretreatment	Downstream of pretreatment	Downstream of RTO
Flow rate	m ³ /h	NA	NA	56 150
Temperature	°C	NA	NA	151
O ₂	vol-%	NA	NA	18.4
Dust	mg/Nm ³	NA	NA	5.6
Benzene	mg/Nm ³	NA	NA	< 0.03
CO	mg/Nm ³	NA	NA	3.8
NO _x (as NO ₂)	mg/Nm ³	NA	NA	62.6
TVOC	mg/Nm ³	NA	NA	8.9
PAH				
Naphthalene	mg/Nm ³	6.1	6.0	0.021
2-Methylnaphthalene	mg/Nm ³	2.8	2.8	0.012
1-Methylnaphthalene	mg/Nm ³	2.0	1.9	0.012
Acenaphthylene	mg/Nm ³	2.3	2.1	0.021
Acenaphthene	mg/Nm ³	2.9	0.5	0.026
Fluorine	mg/Nm ³	2.9	2.6	0.043
Phenanthrene	mg/Nm ³	40.9	39.5	1.104
Anthracene	mg/Nm ³	6.3	5.9	0.154
Fluoranthene	mg/Nm ³	46.3	50.3	3.445
Pyrene	mg/Nm ³	30.6	32.8	2.524
Chrysene	mg/Nm ³	22.9	23.3	3.155
Benzo(a)anthracene	mg/Nm ³	12.3	12.3	1.314
Benzo(b+k)fluoranthene	mg/Nm ³	16.3	17.1	1.739
Benzo(a)pyrene	mg/Nm ³	3.5	4.4	0.386
Dibenzo(a,h)anthracene	mg/Nm ³	0.4	0.4	0.035
Indeno(cd)pyrene	mg/Nm ³	1.8	1.8	0.149
Benzo(g,h,i)perylene	mg/Nm ³	1.8	1.8	0.138

NB: NA=not available
Source: [345, UBA (D) 2009]

Table 10.8 shows emission ranges from RTOs operating in carbon and graphite baking and rebaking processes.

Table 10.8: Example of emissions from RTOs operating in carbon and graphite baking and rebaking processes

Product Furnace type Abatement type	Graphite electrode Open furnace RTO	Special graphite Open furnace ESP + RTO	Cathode Open furnace RTO	Graphite electrode Closed furnace RTO
Component	Range (mg/Nm ³)	Average of 4 measurements in one day (mg/Nm ³)	Average (mg/Nm ³)	Range (mg/Nm ³)
PAH - EPA 16	2.61–19.45	0.989	1.535	2–16
BaP	0.045–0.3	0.015	0.012	0.1–1.0
Benzene	NA	NA	NA	< 1.0
Dust	NA	NA	NA	< 20
NB: NA=not available				

10.2.2 Emissions to water

The production of carbon and graphite shapes is an inherently dry process. Nevertheless, a few water cooling cycles are needed.

The cooling process can be performed using indirect water systems, resulting in a discharge of clean cooling water. Indirect water systems can also be used to cool the flue-gases, to make them suitable for abatement with regular techniques such as bag filters and electrostatic precipitators.

Discharges of process waste water are usually limited to cooling water (e.g. to cool green shapes). Cooling water used to directly cool the green and/or impregnated shapes is treated sufficiently or discharged as waste water. By sedimentation treatment, insoluble materials such as PAH are removed as sludge and discharged according to national regulations.

Considerable amounts of waste water can be discharged when wet systems are used for air pollution control. The waste water produced by wet systems is regarded as a cross-media effect of the abatement techniques. Wet scrubbers and biofilters are sources of contaminated waste water that has to be discharged afterwards.

Rainwater run-off from surfaces and roofs may contain carbon dust and associated material. Open storage of raw materials and deposited solid emissions are other sources of potential contamination. Measures are taken to avoid contaminated rainwater being discharged.

10.2.3 Process residues

The production of carbon and graphite is related to the generation of several by-products, residues and wastes, consisting of solid carbon materials, tar, pitch and mixtures that are comparable to usual trade products.

These materials are generated to a large degree as dust or coarse-grained material, stored in silos or big bags and, if needed after a physical preparation process, commonly reused in the production economic cycle.

Residues obtained from the mechanical preparation and machining stages are usually suitable for reuse within the process as raw materials or are recycled in other processes as fuel or

carburising material, depending on the features. In some cases, carbonised or graphitised material is deliberately produced so that it can be returned as raw material to the production process under controlled conditions.

Refractory bricks from the baking furnaces can be reused in other applications after cleaning or can be disposed of as waste.

Used biological substrate is also disposed of but has some value as a soil conditioner provided that toxic components have been broken down.

Other residues include the material removed during the shaping, cutting and grinding stages together with tar or pitch fractions. Depending on the material, they are usually suitable for recycling within the process as raw materials or in other processes as fuel or carburising material.

10.3 Techniques to consider in the determination of BAT

The sections of this document entitled 'Techniques to consider in the determination of BAT' set out techniques generally considered to have the potential for achieving a high level of environmental protection in the industries within the scope of the document. The background to the way the techniques are described is given in Section 2.12 and Table 2.10.

This section presents a number of techniques for the prevention or reduction of emissions and residues as well as techniques for reducing the overall energy consumption. They are all commercially available. Examples are given in order to demonstrate techniques which illustrate a good environmental performance. The techniques that are given as examples are based on information provided by the industry, European Member States and the evaluation of the European IPPC Bureau. The general techniques described in Chapter 2 on common processes apply to a great extent to the processes in this sector and influence the manner in which the main and associated processes are controlled and operated.

10.3.1 Raw material reception, handling and storage

10.3.1.1 Techniques to reduce emissions from the storage, handling, and transport of solid materials

General techniques applied to reduce diffuse emissions from the storage, handling and transport of raw materials for carbon and graphite production are considered in Chapter 2 (see Section 2.12.4.1) and in the Emissions from Storage BREF [290, COM 2006]. Techniques related to the storage and handling of coke and pitch are considered sector-specific.

Description

The techniques to consider are the use of a bag filter (see Section 2.12.5.1.4) or the use of a cyclone (see Section 2.12.5.1.3) in combination with a bag filter.

Technical description

Raw materials like anthracite, coke, solid pitch, green powder and some powder additives can emit dust during storage, transportation and during mechanical pretreatment processes like grinding. These emissions are usually abated through bag filters (see Section 2.12.5.1.4).

There may be higher emissions during special dust-generating processes, like silo filling and truck loading, due to increased emission loads for very limited periods of time.

Achieved environmental benefits

- Reduction of dust emissions.
- Reduction of PAH particulate emissions.
- Reuse of dust in the process, if possible.

Environmental performance and operational data

Dust emission values after abatement with a bag filter were reported by the ECGA.

Table 10.9: Emissions range based on plant-specific data from handling, storage and transportation

Abatement type	Pollutant	Emissions range (mg/Nm ³)
Bag filter	Dust	< 1–15
	BaP ⁽¹⁾	< 0.01
⁽¹⁾ If solid pitch is processed in special cases, a bag filter can be used to abate BaP particles. <i>Source:</i> [378, Industrial NGOs 2012]		

Values of up to 30 mg/Nm³ can be achieved when using truck loading filters or silo roof filters [345, UBA (D) 2009]

Cross-media effects

- Increase in energy use.
- Generation of waste if dust is not suitable for reuse.

Technical considerations relevant to applicability

Generally applicable.

Economics

Investment costs vary widely depending on the nature and scale of the process. Estimates for a 20 000–50 000 m³/h unit are around EUR 60 000–250 000 and do not include other auxiliary costs like installation, utilities supply, start-up, etc. Upkeep costs are estimated to be around EUR 10 000–50 000/yr.

Driving force for implementation

- Reduction of environmental impacts.
- Material savings. In most cases, and depending on the ingredients, mixture, grain sizes and quality requirements, the collected dust can be reused or sold as a by-product.

Example plants

Almost all European Carbon and Graphite Association (ECGA) member installations.

Reference literature

[381, ECGA 2012]

10.3.1.2 Techniques to reduce emissions from the storage, handling and transport of liquid pitch

Description

The techniques to consider are:

- back-venting of tank gases;
- condensation;
- dry scrubber (see Section 2.12.5.2.3);
- thermal oxidiser (TO) or regenerative thermal oxidiser (RTO) (see Section 2.12.5.2.1) (where required in combination with pretreatment like ESP, see Section 2.12.5.1.1).

Technical description

Due to the fact that flow rates during the use of liquid pitch are relatively small, these handling and storage operations are combined with abatement systems like dry scrubbers (described in Section 2.12.5.2.3) and a TO/RTO (described in Section 2.12.5.2.1) of other steps of the process (for example, the mixing and shaping or the baking process).

10.3.2 Material pretreatment operations

10.3.2.1 Techniques to reduce emissions from calcining of coal and coke

No specific abatement techniques are used. Emission values achieved for both electrically and gas-heated calciners are shown in Section 10.2.

10.3.2.2 Techniques to reduce emissions from mechanical preparation of raw material such as grinding and sieving

The technique to consider is the use of a bag filter. Emissions related to the performance of bag filters after grinding operations are shown in Section 10.3.1.1.

10.3.3 Carbon and graphite production

10.3.3.1 Techniques to reduce dust and PAH emissions from mixing and shaping (production of green paste and green shapes)

Description

The techniques to consider are:

- bag filter (see Section 2.12.5.1.4);
- dry scrubber (see Section 2.12.5.2.3) using dust as an adsorbing agent and followed by a bag filter; it can be preceded by condensation;
- activated coke filter;
- TO or RTO (see Section 2.12.5.2.1).

Technical description

The mixing and shaping of material containing pitch can cause emissions of hydrocarbons, especially at high temperatures. These emissions can be condensed or adsorbed or thermally oxidised.

Bag filter (see Section 2.12.5.1.4)

This is generally not applied for the capture of PAH emissions, only for coke dust.

Condensation

Condensation can be achieved by external and/or internal cooling with air and/or water systems. Condensation is often achieved within conditioning towers. The condensed hydrocarbon particles can be removed from the flue-gas by adsorption scrubbers or ESPs.

Dry scrubber (see Section 2.12.5.2.3) followed by a bag filter

Dust is injected before the off-gas collection, and the dust collection equipment is used downstream for removing the dust with the adsorbed pollutant. Although both bag filters and ESPs can be used as dust collectors, bag filters are typically preferred due to their increased capture efficiency and scrubbing media utilisation. Part of the dust recovered in the bag filter can be recycled several times into the scrubbing network in order to achieve a good mix of fumes and dust. This scrubbing material has to be removed periodically from the system and is often reused within the production process or recycled in other processes, or in rare cases removed for disposal. A typical dry adsorption scrubber with dust injection and dust removal is shown in Figure 10.7.

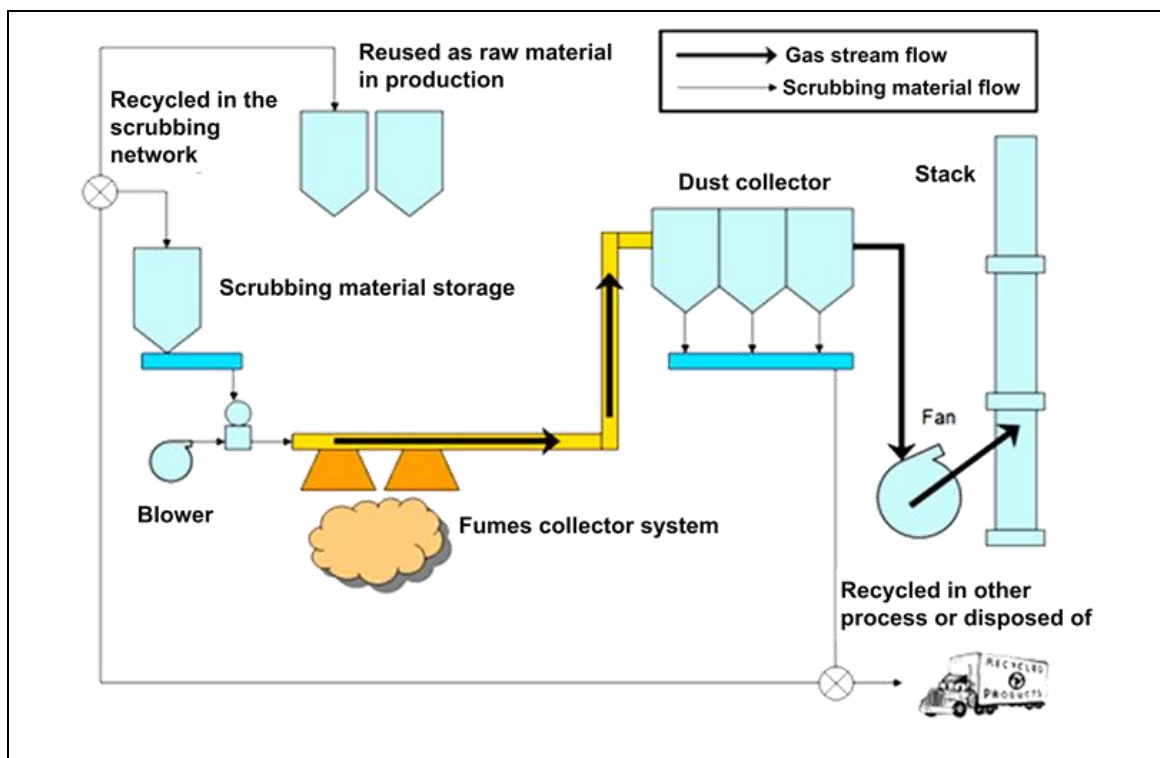

Figure 10.7: Dry adsorption scrubber with dust injection and dust removal

In carbon and graphite electrode production, this is the most commonly used adsorbent technique at this stage of the process.

TO or RTO (see Section 2.12.5.2.1)

Thermal oxidation techniques like TO and RTO systems are also used to reduce emissions from the pastes and green shapes department. Depending on the configuration of the installation, off-gases from mixing and shaping can be treated in a TO/RTO specifically devoted to the mixing and shaping processes (one plant reports using a RTO specifically dedicated to mixing fumes) or in the TO/RTO used in the baking stage (where the RTO is required to be used in combination with a pretreatment such as an ESP), with the latter being the most common option.

Achieved environmental benefits

Bag filter

Reduction of diffuse dust emissions.

Dry scrubber or activated coke filter

- Reduction of dust and hydrocarbon emissions.
- In some cases, dust injection cleans the internal walls of the pipelines.

TO or RTO

- Reduction of hydrocarbon emissions.
- In certain cases like speciality graphite production, the use of a TO (or lime-coated coke) is necessary for H₂S removal.

Environmental performance and operational data

Bag filter

Table 10.10: Emissions range based on plant-specific data for a bag filter in the mixing and shaping stage

Abatement type	Pollutant	Emissions range (mg/Nm ³)
Bag filter	Dust	< 1–10
	BaP	≤ 0.001 (only in the case of low-temperature processes where PAH remain in solid phase)
<i>Source:</i> [378, Industrial NGOs 2012]		

Dry scrubber followed by a bag filter

Table 10.11: Emissions range based on plant-specific data for a dry scrubber followed by bag filter in the mixing and shaping stage

Abatement type	Pollutant	Emissions range (mg/Nm ³)
Dry scrubber followed by bag filter	Dust	< 1–12
	BaP	≤ 0.01
<i>Source:</i> [378, Industrial NGOs 2012]		

Activated coke filter

Table 10.12: Emissions range based on plant-specific data for an activated coke filter in the mixing and shaping stage

Abatement type	Pollutant	Emissions range (mg/Nm ³)
Activated coke filter	Dust	1–8
	BaP	0.001
<i>Source:</i> [378, Industrial NGOs 2012]		

TO

Table 10.13: Emissions range based on plant-specific data for a thermal oxidiser in the mixing and shaping stage

Abatement type	Pollutant	Emissions range (mg/Nm ³)
TO	Dust	1–15
	BaP	No plant-specific data provided
<i>Source:</i> [378, Industrial NGOs 2012]		

RTO

Table 10.14: Emissions range based on plant-specific data for a regenerative thermal oxidiser in the mixing and shaping stage

Abatement type	Pollutant	Emissions range (mg/Nm ³)
RTO	Dust	< 1–10
	BaP	< 0.01
<i>Source:</i> [378, Industrial NGOs 2012]		

Cross-media effects

Bag filter

- Increase in energy consumption.

- Generation of waste if the collected dust is not suitable for reuse.

Dry scrubber or activated coke filter

Generation of waste (although it is rarely sent for disposal as it can usually be reused).

TO or RTO

- Increase in energy use. A RTO can reduce energy consumption by 70 % compared with a TO.
- Increase in CO₂ and NO_x emissions.

Technical considerations relevant to applicability

Bag filter

Generally applicable.

Dry scrubber or activated coke filter

The dust injection technique can only be applied in plants with a sufficient quantity of material for use as scrubbing material. Generally, scrubbing material is recovered from plant dedusting systems.

TO or RTO

Technical considerations relevant to the applicability of TOs and RTOs are reported in Section 10.3.3.2.

Economics

Dry scrubber

The investment cost for a dry scrubbing unit with a flow capacity of 50 000 m³/h is approximately EUR 1.4 million (collection network excluded, installation cost included).

TO or RTO

Economics for TOs and RTOs are reported in Section 10.3.3.2.

Driving force for implementation

Bag filter

Reduction of diffuse dust emissions.

Dry scrubber or activated coke filter

- Reduction of dust and hydrocarbon emissions.
- Recovery of dust and pitch.

TO or RTO

Reduction of hydrocarbon emissions.

Example plants

- Bag filter: Plants 1, 4, 5, 9, 10 and 14.
- Dry scrubber with dust injection followed by a bag filter: Plants 5, 7, 8, 12, 13, 14, 18, 21 and 22.
- Activated coke filter: Plant 7.
- TO: Plant 1.
- RTO: Plants 4, 9, 10, 15 and 16.
- RTO and ESP: Plant 11.

Reference literature

[381, ECGA 2012]

10.3.3.2 Techniques to reduce emissions from baking and rebaking

Description

The techniques to consider are:

- bag filter (see Section 2.12.5.1.4);
- ESP (see Section 2.12.5.1.1);
- TO or RTO (see Section 2.12.5.2.1);
- wet (see Section 2.12.5.2.2) and/or dry scrubber (see Section 2.12.5.2.3).

Technical description

ESPs, TOs and RTOs are the most commonly applied techniques to abate emissions from baking and rebaking furnaces. Wet and dry scrubbers are mainly applied for removing sulphur compounds. With regard to site-specific configurations, usually a combination of the aforementioned techniques is used.

Bag filter

Bag filters are only applied to the handling of the coke packing material.

ESP (see Section 2.12.5.1.1)

ESPs are the most commonly used abatement device for the treatment of tar-containing exhaust gases in the carbon and graphite electrode industry, usually together with a RTO, due especially to the volatile components of the off-gas.

ESP collection plates act as condensation plates. In some cases, depending on the material characteristics, the condensed filter tar can either be used as fuel in a ring furnace or in a RTO. Otherwise, it has to be discharged.

A good gas distribution is guaranteed by specially developed gas distribution elements (discharge wire), which do not even become blocked with viscose tar. In order to attain adequate separation, the optimum diameter of the tar droplets is 200–300 μm . This can be achieved by the injection of a water spray under pressure into the exhaust gas stream flowing countercurrently. The best cleaning results can be achieved with a gas temperature of 50–75 $^{\circ}\text{C}$. If the ESP is used in combination with a RTO, no water injection is normally used. The ESP reduces the low volatile hydrocarbons, with an efficiency of > 95 %. The remaining highly volatile hydrocarbons are destroyed in a RTO or TO at temperatures of > 750 $^{\circ}\text{C}$.

TO (see Section 2.12.5.2.1)

For a high concentration and relatively low flow of fumes, a TO can be used as a good compromise between efficiency, energy consumption and investment cost.

RTO (see Section 2.12.5.2.1)

Depending of the nature of the exhaust gas, a RTO might require pretreatment techniques to be applied. For example, in cases of high raw gas load, a RTO as a stand-alone technique has not been shown to achieve low enough emission values. In these cases, the gases have to be pretreated prior to the RTO to reduce the pitch (especially the long-chained hydrocarbon components).

The most common pretreatment technique applied is an ESP. If it is not possible to use an ESP due to the cooling effects, then a ceramic bed filter can be used (ceramic filters are not applied in the European carbon and graphite industry).

Wet (see Section 2.12.5.2.2) and dry scrubber (see Section 2.12.5.2.3)

In some cases, sulphur must be added to certain materials in order to achieve special properties in the materials and products. Also, some raw materials and combustibles contain sulphur. Wet and/or dry scrubbers are the main abatement technique applied to clean the sulphur compounds from the gases.

Achieved environmental benefits

Bag filter

Reduction of dust emissions.

ESP

Reduction of dust and low volatile hydrocarbon emissions.

TO or RTO

Reduction of hydrocarbon emissions.

Wet and/or dry scrubber

Reduction of sulphur compounds emissions.

Environmental performance and operational data

Emissions reported during the baking process:

Bag filter (handling of the coke packing material)

Table 10.15: Emissions range based on plant-specific data for the handling of the coke packing material

Abatement type	Pollutant	Emissions range (mg/Nm ³)
Bag filter	Dust	0.5–15

Source: [378, Industrial NGOs 2012]

ESP

Table 10.16: Emissions range based on plant-specific data for an ESP in the baking stage

Abatement type	Pollutant	Emissions range (mg/Nm ³)
ESP	Dust	< 1–12
	BaP	< 0.2

Source: [378, Industrial NGOs 2012]

TO

Table 10.17: Emissions range based on plant-specific data for a thermal oxidiser in the baking stage

Abatement type	Pollutant	Emissions range (mg/Nm ³)
TO	Dust	5–20
	SO ₂ ⁽¹⁾	44–220
	NO _x	80–400
	BaP	≤ 0.01

⁽¹⁾ The upper value of the SO₂ range can be explained by a higher sulphur content in the raw materials, the fuel used in furnaces and the packing materials.

Source: [378, Industrial NGOs 2012]

RTO

Table 10.18: Emissions range based on plant-specific data for a regenerative thermal oxidiser in the baking stage

Abatement type	Pollutant	Emissions range (mg/Nm ³)
RTO	Dust	2.5–11
	SO ₂	< 90
	NO _x	35–100
	BaP	< 0.35
<i>Source: [378, Industrial NGOs 2012]</i>		

TO and wet scrubber

Table 10.19: Emissions range based on plant-specific data for a thermal oxidiser and wet scrubber in the baking stage

Abatement type	Pollutant	Emissions range (mg/Nm ³) ⁽¹⁾
TO & wet scrubber	Dust	9–20
	SO ₂	10–90
	NO _x	50–70
	BaP	< 0.01
⁽¹⁾ Emissions range based on just one plant. <i>Source: [378, Industrial NGOs 2012]</i>		

ESP and RTO

Table 10.20: Emissions range based on plant-specific data for an ESP and regenerative thermal oxidiser in the baking stage

Abatement type	Pollutant	Emissions range (mg/Nm ³)
ESP & RTO	Dust	< 5–10
	SO ₂	40–100
	NO _x	32–100
	BaP	< 0.02
	TVOC	1–10
<i>Source: [378, Industrial NGOs 2012]</i>		

RTO and dry scrubber

Table 10.21: Emissions range based on plant-specific data for a RTO and dry scrubber in the baking stage

Abatement type	Pollutant	Emissions range (mg/Nm ³) ⁽¹⁾
RTO & dry scrubber	Dust	< 5
	SO ₂	< 200
	NO _x	16–20
	BaP	< 0.01
⁽¹⁾ Emissions range based on just one plant. <i>Source: [378, Industrial NGOs 2012]</i>		

Table 10.22: Emissions range based on plant-specific data for an ESP and activated coke filter in the baking stage

Abatement type	Pollutant	Emissions range (mg/Nm ³) ⁽¹⁾
ESP & activated coke filter	Dust	1.8–15
	SO ₂	26–65
	NO _x	8–27
	CO	366–892
	BaP	0.01–0.02
	Toluene	0.5–1.1
	Xylene	0.5–1.7
⁽¹⁾ Emissions range based on just one plant. Source: [378, Industrial NGOs 2012]		

Emissions reported during the rebaking process:

Bag filter

Table 10.23: Emissions range based on plant-specific data for a bag filter in the rebaking stage

Abatement type	Pollutant	Emissions range (mg/Nm ³)
Bag filter	Dust	< 5
Source: [378, Industrial NGOs 2012]		

TO

Table 10.24: Emissions range based on plant-specific data for a thermal oxidiser in the rebaking stage

Abatement type	Pollutant	Emissions range (mg/Nm ³)
TO	Dust	5–20
	SO ₂ ⁽¹⁾	4–220
	NO _x	12–400
	BaP	< 0.003
⁽¹⁾ The upper value of the SO ₂ range can be explained by a higher sulphur content in the raw materials, the fuel used in furnaces and the packing materials. Source: [378, Industrial NGOs 2012]		

Cross-media effects

Bag filter

- Increase in energy consumption.
- Generation of waste if the collected dust is not suitable for reuse.

ESP

- Increase in energy consumption.
- Generation of waste the collected dust is not suitable for reuse.

TO or RTO

- Increase in energy use. If no pretreatment is applied, a RTO can reduce energy consumption by 70 % compared with a TO.
- Increase in CO₂ and NO_x emissions.

Wet and/or dry scrubber

- Generation of waste (although it is rarely sent for disposal as it can usually be reused).
- Generation of waste water in the case of a wet scrubber.

Technical considerations relevant to applicability*ESP and RTO*

Generally applicable.

TO

TOs are not applicable to continuous ring furnaces, as these require very high quantities of energy to heat the high volume of fumes to be treated.

Dry scrubber

Dust injection techniques can only be applied in plants with a sufficient quantity of material for use as scrubbing material. Generally, scrubbing material is recovered from plant dedusting systems.

Economics*TO*

The investment cost was EUR 1 million for 30 000 Nm³/h of fume capacity (France).

A TO implies a much lower investment than a RTO.

RTO

In Germany, two new RTOs each with a capacity of approximately 60 000 Nm³/h were built and started up in 2011, generating costs of EUR 2 million each, including auxiliary plants.

A French plant invested EUR 8 million to equip a RTO, which was started up in 2013.

Driving force for implementation*Bag filter*

Reduction of dust emissions.

ESP

Reduction of dust and hydrocarbon emissions.

TO or RTO

Reduction of hydrocarbon emissions.

Wet and/or dry scrubber

- Reduction of sulphur compounds.
- Reduction of hydrocarbon emissions (dry scrubber).

Example plants

- Bag filter: Plants 3, 4, 5, 8, 11, 21 and 22.
- ESP: Plants 1, 4, 5, 6, 8 and 20.
- TO: Plants 1, 2, 3, 4, 5, 6, 7, 11, 18, 19, 21 and 22.
- RTO: Plants 10, 14 and 20.
- TO and wet scrubber: Plant 9.
- ESP and RTO: Plants 2, 4, 5 and 11.
- RTO and dry scrubber: Plant 1.
- ESP and activated coke filter: Plant 7.

Reference literature

[381, ECGA 2012]

10.3.3.3 Techniques to reduce emissions from impregnation

Description

The techniques to consider are the following:

- Dry scrubber (see Section 2.12.5.2.3).
- Activated coke filter.
- TO (see Section 2.12.5.2.1).
- Wet scrubber (see Section 2.12.5.2.2), biofilter or bioscrubber. A biofilter consists of a bed of organic material, where pollutants from waste gas streams are biologically oxidised by naturally occurring microorganisms. Bioscrubbers combine wet gas scrubbing (absorption) and biodegradation; the scrubbing water contains a population of microorganisms suitable to oxidise the noxious gas components.

Technical description

TOs and dry scrubbers are the techniques generally applied during the impregnation stage, while wet scrubbers, biofilters and bioscrubbers are only applied in the production of speciality graphite where special impregnation agents like resins are used. TOs and dry and wet scrubbers are already described in previous sections (10.3.3.1 and 10.3.3.2), so only information related to their environmental performance and example plants is included here.

Activated coke filter

An activated coke filter is placed in a container. Pitch fumes are sucked through the coke bed in either the reverse flow or cross flow technique by the extraction fan and are adsorbed on the coke particles. The filtered gases are then released to the environment by the fan through the exhaust stack. Grates are movable in order to be cleaned.

Only one EU plant reported using an activated coke filter at this stage of the process.

Biofilter and bioscrubber

Air flows through the packed bed of the biofilter, and the pollutant is transferred into a thin biofilm on the surface of the packing material. Microorganisms, including bacteria and fungi, are immobilised in the biofilm and degrade the pollutant.

One of the main challenges to optimise biofilter operation is to maintain sufficient moisture throughout the system. The air is normally humidified before it enters the bed with a watering (spray) system, humidification chamber, bioscrubber or biotrickling filter. Properly maintained, a natural organic media like peat, vegetable mulch, bark or woodchips may last for several years, but engineered, combined natural organic and synthetic component packing materials will generally last up to 10 years.

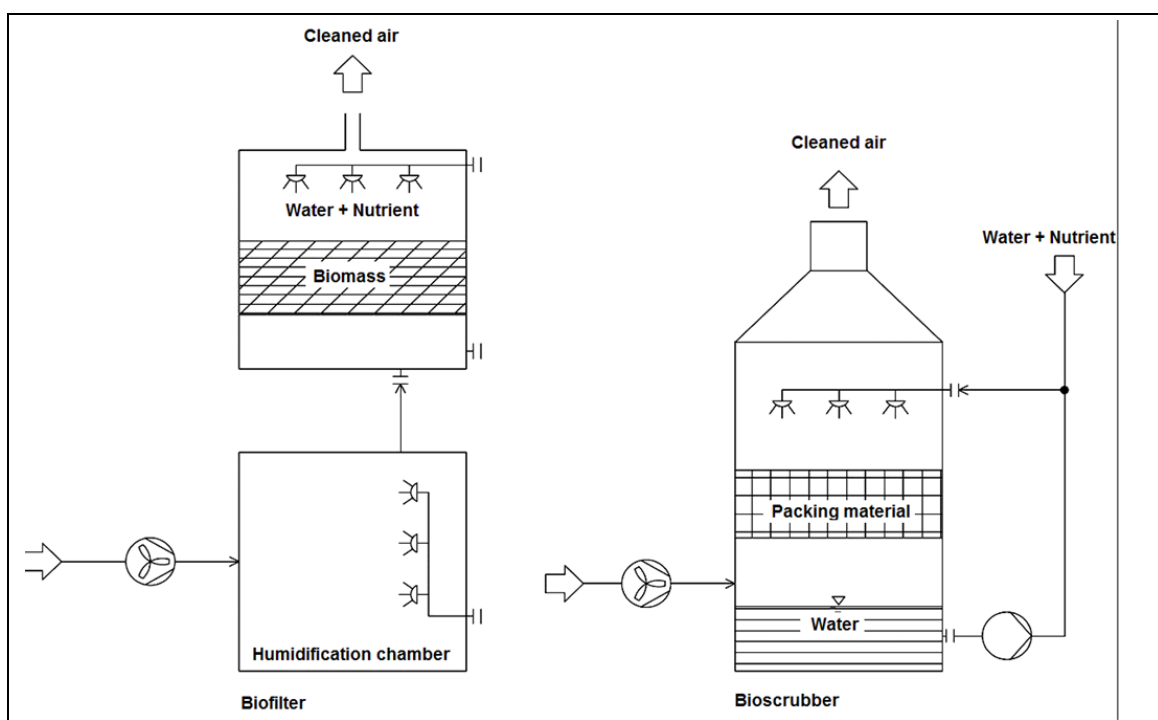

Figure 10.8: Biofilter and bioscrubber

Achieved environmental benefits

Activated coke filter

Reduction of dust and hydrocarbon emissions.

Biofilter and bioscrubber

Reduction of VOC emissions.

Environmental performance and operational data

Dry scrubber (including activated coke filter)

Table 10.25: Emissions range based on plant-specific data for a dry scrubber in the impregnation stage

Abatement type	Pollutant	Emissions range (mg/Nm ³)
Dry scrubber	Dust	< 5–10
	BaP	< 0.01

Source: [378, Industrial NGOs 2012]

TO

Table 10.26: Emissions range based on plant-specific data for a thermal oxidiser in the impregnation stage

Abatement type	Pollutant	Emissions range (mg/Nm ³)
TO	Dust	< 5
	SO ₂	10–200
	NO _x	80–200
	BaP	≤ 0.05

Source: [378, Industrial NGOs 2012]

Biofilter and bioscrubber (only for some speciality production processes)

Table 10.27: Emissions range based on plant-specific data for a biofilter and bioscrubber in the impregnation stage

Abatement type	Pollutant	Emissions range (mg/Nm ³)
Biofilter	TVOC	17–37 *
Bioscrubber	Phenol	0.2–0.9
Bioscrubber	Formaldehyde	< 0.2
* VOC emissions of less than 20 mg/Nm ³ are achieved. Source: [378, Industrial NGOs 2012]		

Other special impregnation processes (only for some speciality production processes)

Table 10.28: Emissions range based on plant-specific data for special impregnation processes

Abatement type	Pollutant	Emissions range (mg/Nm ³)
Bag filter	Dust	< 5
	Cu	0.0001–0.0005
	Sn	0.0003
Activated carbon filter	Tetrachloroethylene	1.8–2.7
Source: [378, Industrial NGOs 2012]		

Cross-media effects

Activated coke filter

Generation of waste (although it is rarely sent for disposal as it can usually be reused).

Technical considerations relevant to applicability

Biofilter and bioscrubber

These techniques are applied primarily during the production of speciality graphite to treat malodorous compounds and water-soluble VOCs that appear when resins and biodegradable solvents are used.

Economics

No information provided.

Driving force for implementation

Activated coke filter

- Reduction of dust and hydrocarbon emissions.
- Recovery of dust and pitch.

Biofilter and bioscrubber

Reduction of VOC emissions.

Example plants

- Dry scrubber: Plants 18, 21 and 22.
- Activated coke filter: Plant 7.
- TO: Plants 2, 4, 5 and 11.
- Biofilter and bioscrubber: Plant 9.

Reference literature

[381, ECGA 2012]

10.3.3.4 Techniques to reduce emissions from graphitising

Description

The techniques to consider are:

- bag filter (in combination with cyclones) (see Section 2.12.5.1.4);
- dry (see Section 2.12.5.2.3) or wet scrubber (see Sections 2.12.5.1.6 and 2.12.5.2.2).

Bag filters and dry and wet scrubbers were already described in previous sections (10.3.3.1 and 10.3.3.2), so only information related to their environmental performance and example plants is included here.

Environmental performance and operational data

Bag filter

Table 10.29: Emissions range based on plant-specific data for a bag filter in the graphitising stage

Abatement type	Pollutant	Emissions range (mg/Nm ³)
Bag filter	Dust	< 1–10
<i>Source: [378, Industrial NGOs 2012]</i>		

Wet scrubber (NaOH)

Table 10.30: Emissions range based on plant-specific data for a wet scrubber in the graphitising stage

Abatement type	Pollutant	Emissions range (mg/Nm ³)
Wet scrubber ⁽¹⁾	Dust	5–10
	SO ₂	20–100
	SO ₂	350
⁽¹⁾ Only in very limited periods of furnace handling (e.g. unloading of hot furnace) is the wet scrubber used. <i>Source: [378, Industrial NGOs 2012]</i>		

Example plants

- Bag filter: Plants 1, 2, 4, 5, 6, 10, 11, 21 and 22.
- Wet scrubber: Plants 2, 7 and 11.

Reference literature

[381, ECGA 2012]

10.3.3.5 Techniques to reduce emissions from machining

Description

The technique to consider is the use of a bag filter.

The bag filter is already described in Section 10.3.1.1, so only information related to its environmental performance and example plants is included here.

Environmental performance and operational data

Table 10.31: Emissions range based on plant-specific data for a bag filter in the machining stage

Abatement type	Pollutant	Emissions range (mg/Nm ³)
Bag filter	Dust	< 1–10
<i>Source:</i> [378, Industrial NGOs 2012]		

Example plants

Plants 1, 2, 3, 4, 5, 6, 7, 8, 11, 14, 15, 21 and 22.

Reference literature

[381, ECGA 2012]

10.3.3.6 Techniques to reduce emissions from special carbon manufacturing processes

During carbon and graphite fibre production using PAN, cyanide emissions occur. A RTO allows the achievement of emission values of < 2–5 mg/Nm³.

10.3.4 Waste water**10.3.4.1 Techniques to prevent and control emissions of waste water**

The techniques to consider are the following:

- Use of indirect water systems for cooling processes, when possible, resulting in a discharge of clean cooling water.
- Reuse of treated water. In a number of installations, cooling water and treated waste water (including rainwater) are reused or recycled within the process.
- Use of spill containment measures for storage equipment to prevent spills reaching sewer systems.
- Procedures for loading/unloading operations and emergency procedures in case of spills.

10.3.4.2 Techniques to reduce emissions of waste water

All waste water (e.g. cooling water used in direct contact with green and/or impregnated shapes, water used during machining operations, waste water from abatement equipment) is treated to remove hydrocarbons and solids. The techniques listed in Section 2.12.6.2 are the techniques to consider and should make it feasible to operate the process on a closed cycle without the generation of waste water.

When it is not possible to avoid the contact of water with contaminated material, the water is sent to a treatment plant (internal or external).

10.3.5 Process residues

The technique to consider is the reuse or recycling of carbon materials, graphite and other residues from the production process within the process or in other external production processes, as far as possible.

10.4 Emerging techniques

No information provided.

11 BEST AVAILABLE TECHNIQUES (BAT) CONCLUSIONS

Scope

These BAT conclusions concern certain activities specified in Sections 2.1, 2.5 and 6.8 of Annex I to Directive 2010/75/EU, namely:

- 2.1: Metal ore (including sulphide ore) roasting or sintering;
- 2.5: Processing of non-ferrous metals:
 - (a) production of non-ferrous crude metals from ore, concentrates or secondary raw materials by metallurgical, chemical or electrolytic processes;
 - (b) melting, including the alloyage, of non-ferrous metals, including recovered products and operation of non-ferrous metal foundries, with a melting capacity exceeding 4 tonnes per day for lead and cadmium or 20 tonnes per day for all other metals;
- 6.8: Production of carbon (hard-burnt coal) or electrographite by means of incineration or graphitisation.

In particular, these BAT conclusions cover the following processes and activities:

- primary and secondary production of non-ferrous metals;
- the production of zinc oxide from fumes during the production of other metals;
- the production of nickel compounds from liquors during the production of a metal;
- the production of silicon-calcium (CaSi) and silicon (Si) in the same furnace as the production of ferro-silicon;
- the production of aluminium oxide from bauxite prior to the production of primary aluminium, where this is an integral part of the production of the metal;
- the recycling of aluminium salt slag;
- the production of carbon and/or graphite electrodes.

These BAT conclusions do not address the following activities or processes:

- Iron ore sintering. This is covered in the BAT conclusions for Iron and Steel production.
- The production of sulphuric acid based on SO₂ gases from non-ferrous metals production. This is covered in the BAT conclusions on Large Volume Inorganic Chemicals – Ammonia, Acids and Fertilisers.
- Foundries covered in the BAT conclusions for the Smitheries and Foundries Industry.

Other reference documents which could be of relevance for the activities covered in these BAT conclusions are the following.

Reference document	Subject
Energy Efficiency (ENE)	General aspects of energy efficiency
Common Waste Water and Waste Gas Treatment/Management Systems in the Chemical Sector (CWW)	Waste water treatment techniques to reduce emissions of metals to water
Large Volume Inorganic Chemicals – Ammonia, Acids and Fertilisers (LVIC-AAF)	Sulphuric acid production
Industrial Cooling Systems (ICS)	Indirect cooling with water and/or air
Emissions from Storage (EFS)	Storage and handling of materials
Economics and Cross-media Effects (ECM)	Economics and cross-media effects of techniques
Monitoring of Emissions to Air and Water from IED installations (ROM)	Monitoring of emissions to air and water
Waste Treatments Industries (WT)	Waste handling and treatment
Large Combustion Plants (LCP)	Combustion plants generating steam and/or electricity
Surface Treatment Using Organic Solvents (STS)	Non-acid pickling
Surface Treatment of Metals and Plastics (STM)	Acid pickling

Definitions

For the purposes of these BAT conclusions, the following definitions apply:

Term used	Definition
New plant	A plant first permitted at the site of the installation following the publication of these BAT conclusions or a complete replacement of a plant on the existing foundations of the installation following the publication of these BAT conclusions
Existing plant	A plant that is not a new plant
Major upgrade	A major change in the design or technology of a plant and with major adjustments or replacements of the process units and associated equipment
Primary emissions	Emissions directly vented from the furnaces that are not spread to the areas surrounding the furnaces
Secondary emissions	Emissions escaping from the furnace lining or during operations such as charging or tapping and which are captured with a hood or enclosure (such as doghouse)
Primary production	Production of metals using ores and concentrates
Secondary production	Production of metals using residues and/or scraps, including remelting and alloying processes
Continuous measurement	Measurement using an 'automated measuring system' permanently installed on site for the continuous monitoring of emissions
Periodic measurement	Determination of a measurand (a particular quantity subject to measurement) at specified time intervals using manual or automated methods

General considerations

Best Available Techniques

The techniques listed and described in these BAT conclusions are neither prescriptive nor exhaustive. Other techniques may be used that ensure at least an equivalent level of environmental protection.

Unless otherwise stated, the BAT conclusions are generally applicable.

Emission levels to air associated with BAT

Emission levels associated with the best available techniques (BAT-AELs) for emissions to air given in these BAT conclusions refer to standard conditions: dry gas at a temperature of 273.15 K, and a pressure of 101.3 kPa.

Averaging periods for emissions to air

For averaging periods for emissions to air, the following definitions apply.

Daily average	Average over a period of 24 hours of valid half-hourly or hourly averages obtained by continuous measurements
Average over the sampling period	Average value of three consecutive measurements of at least 30 minutes each, unless otherwise stated ⁽¹⁾
⁽¹⁾ For batch processes, the average of a representative number of measurements taken over the total batch time or the result of a measurement carried out over the total batch time can be used.	

Averaging periods for emissions to water

For averaging periods for emissions to water, the following definition applies.

Daily average	Average over a sampling period of 24 hours taken as a flow-proportional composite sample (or as a time-proportional composite sample provided that sufficient flow stability is demonstrated) ⁽¹⁾
⁽¹⁾ For discontinuous flows, a different sampling procedure yielding representative results (e.g. spot sampling) can be used.	

Acronyms

Term	Meaning
BaP	Benzo[<i>a</i>]pyrene
ESP	Electrostatic precipitator
I-TEQ	International toxic equivalency derived by applying international toxic equivalence factors, as defined in Annex VI, part 2 of Directive 2010/75/EU
NO _x	The sum of nitrogen monoxide (NO) and nitrogen dioxide (NO ₂), expressed as NO ₂
PCDD/F	Polychlorinated dibenzo- <i>p</i> -dioxins and dibenzofurans (17 congeners)
PAH	Polycyclic aromatic hydrocarbons
TVOC	Total volatile organic carbon; total volatile organic compounds which are measured by a flame ionisation detector (FID) and expressed as total carbon
VOC	Volatile organic compounds as defined in Article 3(45) of Directive 2010/75/EU

11.1 General BAT conclusions

Any relevant process-specific BAT conclusions in Sections 11.2 to 11.9 apply in addition to the general BAT conclusions in this section.

11.1.1 Environmental management systems (EMS)

BAT 1. In order to improve the overall environmental performance, BAT is to implement and adhere to an environmental management system (EMS) that incorporates all of the following features:

- a. commitment of the management, including senior management;
- b. definition of an environmental policy that includes the continuous improvement of the installation by the management;
- c. planning and establishing the necessary procedures, objectives and targets, in conjunction with financial planning and investment;
- d. implementation of procedures paying particular attention to:
 - i. structure and responsibility,
 - ii. recruitment, training, awareness and competence,
 - iii. communication,
 - iv. employee involvement,
 - v. documentation,
 - vi. effective process control,
 - vii. maintenance programmes,
 - viii. emergency preparedness and response,
 - ix. safeguarding compliance with environmental legislation;
- e. checking performance and taking corrective action, paying particular attention to:
 - i. monitoring and measurement (see also the Reference Report on Monitoring of emissions to Air and Water from IED installations – ROM),
 - ii. corrective and preventive action,
 - iii. maintenance of records,
 - iv. independent (where practicable) internal or external auditing in order to determine whether or not the EMS conforms to planned arrangements and has been properly implemented and maintained;
- f. review of the EMS and its continuing suitability, adequacy and effectiveness by senior management;
- g. following the development of cleaner technologies;
- h. consideration for the environmental impacts from the eventual decommissioning of the installation at the stage of designing a new plant, and throughout its operating life;
- i. application of sectoral benchmarking on a regular basis.

The establishment and implementation of an action plan on diffuse dust emissions (see BAT 6) and the application of a maintenance management system which especially addresses the performance of dust abatement systems (see BAT 4) are also a part of the EMS.

Applicability

The scope (e.g. level of detail) and nature of the EMS (e.g. standardised or non-standardised) will generally be related to the nature, scale and complexity of the installation, and the range of environmental impacts it may have.

11.1.2 Energy management

BAT 2. In order to use energy efficiently, BAT is to use a combination of the techniques given below.

	Technique	Applicability
a	Energy efficiency management system (e.g. ISO 50001)	Generally applicable
b	Regenerative or recuperative burners	Generally applicable
c	Heat recovery (e.g. steam, hot water, hot air) from waste process heat	Only applicable for pyrometallurgical processes
d	Regenerative thermal oxidiser	Only applicable when the abatement of a combustible pollutant is required
e	Preheat the furnace charge, combustion air or fuel using the heat recovered from hot gases from the melting stage	Only applicable for roasting or smelting of sulphide ore/concentrate and for other pyrometallurgical processes
f	Raise the temperature of the leaching liquors using steam or hot water from waste heat recovery	Only applicable for alumina or hydrometallurgical processes
g	Use hot gases from the launder as preheated combustion air	Only applicable for pyrometallurgical processes
h	Use oxygen-enriched air or pure oxygen in the burners to reduce energy consumption by allowing autogenous smelting or the complete combustion of carbonaceous material	Only applicable for furnaces that use raw materials containing sulphur or carbon
i	Dry concentrates and wet raw materials at low temperatures	Only applicable when drying is performed
j	Recover the chemical energy content of the carbon monoxide produced in an electric or shaft/blast furnace by using the exhaust gases as a fuel, after the removal of metals, in other production processes or to produce steam/hot water or electricity	Only applicable to exhaust gases with a CO content > 10 vol-%. Applicability is also influenced by the composition of the exhaust gas and the unavailability of a continuous flow (i.e. batch processes)
k	Recirculate the flue-gas back through an oxy-fuel burner to recover the energy contained in the total organic carbon present	Generally applicable
l	Suitable insulation for high temperature equipment such as steam and hot water pipes	Generally applicable
m	Use the heat generated from the production of sulphuric acid from sulphur dioxide to preheat gas directed to the sulphuric acid plant or to generate steam and/or hot water	Only applicable for non-ferrous metals plants including sulphuric acid or liquid SO ₂ production
n	Use high efficiency electric motors equipped with variable-frequency drive, for equipment such as fans	Generally applicable
o	Use control systems that automatically activate the air extraction system or adjust the extraction rate depending on actual emissions	Generally applicable

11.1.3 Process control

BAT 3. In order to improve overall environmental performance, BAT is to ensure stable process operation by using a process control system together with a combination of the techniques given below.

	Technique
a	Inspect and select input materials according to the process and the abatement techniques applied
b	Good mixing of the feed materials to achieve optimum conversion efficiency and reduce emissions and rejects
c	Feed weighing and metering systems
d	Processors to control material feed rate, critical process parameters and conditions including the alarm, combustion conditions and gas additions
e	On-line monitoring of the furnace temperature, furnace pressure and gas flow
f	Monitor the critical process parameters of the air emission abatement plant such as gas temperature, reagent metering, pressure drop, ESP current and voltage, scrubbing liquid flow and pH and gaseous components (e.g. O ₂ , CO, VOC)
g	Control dust and mercury in the exhaust gas before transfer to the sulphuric acid plant for plants including sulphuric acid or liquid SO ₂ production
h	On-line monitoring of vibrations to detect blockages and possible equipment failure
i	On-line monitoring of the current, voltage and electrical contact temperatures in electrolytic processes
j	Temperature monitoring and control at melting and smelting furnaces to prevent the generation of metal and metal oxide fumes through overheating
k	Processor to control the reagents feeding and the performance of the waste water treatment plant, through on-line monitoring of temperature, turbidity, pH, conductivity and flow

BAT 4. In order to reduce channelled dust and metal emissions to air, BAT is to apply a maintenance management system which especially addresses the performance of dust abatement systems as part of the environmental management system (see BAT 1).

11.1.4 Diffuse emissions

11.1.4.1 General approach for the prevention of diffuse emissions

BAT 5. In order to prevent or, where this is not practicable, to reduce diffuse emissions to air and water, BAT is to collect diffuse emissions as much as possible nearest to the source and treat them.

BAT 6. In order to prevent or, where this is not practicable, to reduce diffuse dust emissions to air, BAT is to set up and implement an action plan on diffuse dust emissions, as part of the environmental management system (see BAT 1), that incorporates both of the following measures:

- a. identify the most relevant diffuse dust emission sources (using e.g. EN 15445);
- b. define and implement appropriate actions and techniques to prevent or reduce diffuse emissions over a given time frame.

11.1.4.2 Diffuse emissions from the storage, handling and transport of raw materials

BAT 7. In order to prevent diffuse emissions from the storage of raw materials, BAT is to use a combination of the techniques given below.

	Technique
a	Enclosed buildings or silos/bins for storing dust-forming materials such as concentrates, fluxes and fine materials
b	Covered storage of non-dust-forming materials such as concentrates, fluxes, solid fuels, bulk materials and coke and secondary materials that contain water-soluble organic compounds
c	Sealed packaging of dust-forming materials or secondary materials that contain water-soluble organic compounds
d	Covered bays for storing material which has been pelletised or agglomerated
e	Use water sprays and fog sprays with or without additives such as latex for dust-forming materials
f	Dust/gas extraction devices placed at the transfer and tipping points for dust-forming materials
g	Certified pressure vessels for storing chlorine gas or mixtures that contain chlorine
h	Tank construction materials that are resistant to the contained materials
i	Reliable leak detection systems and display of tank's level, with an alarm to prevent overfills
j	Store reactive materials in double-walled tanks or tanks placed in chemical-resistant bunds of the same capacity and use a storage area that is impermeable and resistant to the material stored
k	Design storage areas so that - any leaks from tanks and delivery systems are intercepted and contained in bunds that have a capacity capable of containing at least the volume of the largest storage tank within the bund; - delivery points are within the bund to collect any spilled material
l	Use inert gas blanketing for the storage of materials that react with air
m	Collect and treat emissions from storage with an abatement system designed to treat the compounds stored. Collect and treat before discharge any water that washes dust away.
n	Regular cleaning of the storage area and, when needed, moistening with water
o	Place the longitudinal axis of the heap parallel to the prevailing wind direction in the case of outdoor storage
p	Protective planting, windbreak fences or upwind mounts to lower the wind velocity in the case of outdoor storage
q	One heap instead of several where feasible in the case of outdoor storage
r	Use oil and solid interceptors for the drainage of open outdoor storage areas. Use of concreted areas that have kerbs or other containment devices for the storage of material that can release oil, such as swarf

Applicability

BAT 7.e is not applicable to processes that require dry materials or ores/concentrates that naturally contain sufficient humidity to prevent dust formation. The applicability may be limited in regions with water shortages or with very low temperatures.

BAT 8. In order to prevent diffuse emissions from the handling and transport of raw materials, BAT is to use a combination of the techniques given below.

	Technique
a	Enclosed conveyors or pneumatic systems to transfer and handle dust-forming concentrates and fluxes and fine-grained material
b	Covered conveyors to handle non-dust-forming solid materials
c	Extraction of dust from delivery points, silo vents, pneumatic transfer systems and conveyor transfer points, and connection to a filtration system (for dust-forming materials)
d	Closed bags or drums to handle materials with dispersible or water-soluble components
e	Suitable containers to handle pelletised materials
f	Sprinkling to moisten the materials at handling points
g	Minimise transport distances
h	Reduce the drop height of conveyor belts, mechanical shovels or grabs
i	Adjust the speed of open belt conveyors (< 3.5 m/s)
j	Minimise the speed of descent or free fall height of the materials
k	Place transfer conveyors and pipelines in safe, open areas above ground so that leaks can be detected quickly and damage from vehicles and other equipment can be prevented. If buried pipelines are used for non-hazardous materials, document and mark their course and adopt safe excavation systems
l	Automatic resealing of delivery connections for handling liquid and liquefied gas
m	Back-vent displaced gases to the delivery vehicle to reduce emissions of VOC
n	Wash wheels and chassis of vehicles used to deliver or handle dusty materials
o	Use planned campaigns for road sweeping
p	Segregate incompatible materials (e.g. oxidising agents and organic materials)
q	Minimise material transfers between processes

Applicability

BAT 8.n. may not be applicable when ice could be formed.

11.1.4.3 Diffuse emissions from metal production

BAT 9. In order to prevent or, where this is not practicable, to reduce diffuse emissions from metal production, BAT is to optimise the efficiency of off-gas collection and treatment by using a combination of the techniques given below.

	Technique	Applicability
a	Thermal or mechanical pretreatment of secondary raw material to minimise organic contamination of the furnace feed	Generally applicable
b	Use a closed furnace with a properly designed dedusting system or seal the furnace and other process units with an adequate vent system	The applicability may be restricted by safety constraints (e.g. type/design of the furnace, risk of explosion)
c	Use a secondary hood for furnace operations such as charging and tapping	The applicability may be restricted by safety constraints (e.g. type/design of the furnace, risk of explosion)
d	Dust or fume collection where dusty material transfers take place (e.g. furnace charging and tapping points, covered launders)	Generally applicable
e	Optimise the design and operation of hooding and ductwork to capture fumes arising from the feed port and from hot metal, matte or slag tapping and transfers in covered launders	For existing plants, the applicability may be limited by space and plant configuration restrictions
f	Furnace/reactor enclosures such as 'house-in-house' or 'doghouse' for tapping and charging operations	For existing plants, the applicability may be limited by space and plant configuration restrictions
g	Optimise the off-gas flow from the furnace through computerised fluid dynamics studies and tracers	Generally applicable
h	Charging systems for semi-closed furnaces to add raw materials in small amounts	Generally applicable
i	Treat the collected emissions in an adequate abatement system	Generally applicable

11.1.5 Monitoring of emissions to air

BAT 10. BAT is to monitor the stack emissions to air with at least the frequency given below and in accordance with EN standards. If EN standards are not available, BAT is to use ISO, national or other international standards that ensure the provision of data of an equivalent scientific quality.

Parameter	Monitoring associated with	Minimum monitoring frequency	Standard(s)
	<p>Copper: BAT 38, BAT 39, BAT 40, BAT 43, BAT 44, BAT 45</p> <p>Aluminium: BAT 56, BAT 58, BAT 59, BAT 60, BAT 61, BAT 67, BAT 81, BAT 88</p> <p>Lead, Tin: BAT 94, BAT 96, BAT 97</p> <p>Zinc, Cadmium: BAT 119, BAT 122</p> <p>Precious metals: BAT 140</p> <p>Ferro-alloys: BAT 155, BAT 156, BAT 157, BAT 158</p> <p>Nickel, Cobalt: BAT 171</p> <p>Other non-ferrous metals: emissions from production stages such as raw material pretreatment, charging, smelting, melting and tapping</p>	Continuous ⁽¹⁾	EN 13284-2
Dust ⁽²⁾	<p>Copper: BAT 37, BAT 38, BAT 40, BAT 41, BAT 42, BAT 43, BAT 44, BAT 45</p> <p>Aluminium: BAT 56, BAT 58, BAT 59, BAT 60, BAT 61, BAT 66, BAT 67, BAT 68, BAT 80, BAT 81, BAT 82, BAT 88</p> <p>Lead, Tin: BAT 94, BAT 95, BAT 96, BAT 97</p> <p>Zinc, Cadmium: BAT 113, BAT 119, BAT 121, BAT 122, BAT 128, BAT 132</p> <p>Precious metals: BAT 140</p> <p>Ferro-alloys: BAT 154, BAT 155, BAT 156, BAT 157, BAT 158</p> <p>Nickel, Cobalt: BAT 171</p> <p>Carbon/graphite: BAT 178, BAT 179, BAT 180, BAT 181</p> <p>Other non-ferrous metals: emissions from production stages such as raw material pretreatment, charging, smelting, melting and tapping</p>	Once per year ⁽¹⁾	EN 13284-1
Antimony and its compounds,	<p>Lead, Tin: BAT 96, BAT 97</p>	Once per year	EN 14385

Parameter	Monitoring associated with	Minimum monitoring frequency	Standard(s)
expressed as Sb			
Arsenic and its compounds, expressed as As	Copper: BAT 37, BAT 38, BAT 39, BAT 40, BAT 42, BAT 43, BAT 44, BAT 45 Lead, Tin: BAT 96, BAT 97 Zinc: BAT 122	Once per year	EN 14385
Cadmium and its compounds, expressed as Cd	Copper: BAT 37, BAT 38, BAT 39, BAT 40, BAT 41, BAT 42, BAT 43, BAT 44, BAT 45 Lead, Tin: BAT 94, BAT 95, BAT 96, BAT 97 Zinc, Cadmium: BAT 122, BAT 132 Ferro-alloys: BAT 156	Once per year	EN 14385
Chromium (VI)	Ferro-alloys: BAT 156	Once per year	No EN standard available
Copper and its compounds, expressed as Cu	Copper: BAT 37, BAT 38, BAT 39, BAT 40, BAT 42, BAT 43, BAT 44, BAT 45 Lead, Tin: BAT 96, BAT 97	Once per year	EN 14385
Nickel and its compounds, expressed as Ni	Nickel, Cobalt: BAT 172, BAT 173	Once per year	EN 14385
Lead and its compounds, expressed as Pb	Copper: BAT 37, BAT 38, BAT 39, BAT 40, BAT 41, BAT 42, BAT 43, BAT 44, BAT 45 Lead, Tin: BAT 94, BAT 95, BAT 96, BAT 97 Ferro-alloys: BAT 156	Once per year	EN 14385
Thallium and its compounds, expressed as Tl	Ferro-alloys: BAT 156	Once per year	EN 14385
Zinc and its compounds, expressed as Zn	Zinc, Cadmium: BAT 113, BAT 114, BAT 119, BAT 121, BAT 122, BAT 128, BAT 132	Once per year	EN 14385
Other metals, if relevant ⁽³⁾	Copper: BAT 37, BAT 38, BAT 39, BAT 40, BAT 41, BAT 42, BAT 43, BAT 44, BAT 45 Lead, Tin: BAT 94, BAT 95, BAT 96, BAT 97 Zinc, Cadmium: BAT 113, BAT 119, BAT 121, BAT 122, BAT 128, BAT 132 Precious metals: BAT 140 Ferro-alloys: BAT 154, BAT 155, BAT 156, BAT 157, BAT 158 Nickel, Cobalt:	Once per year	EN 14385

Parameter	Monitoring associated with	Minimum monitoring frequency	Standard(s)
	BAT 171 Other non-ferrous metals		
Mercury and its compounds, expressed as Hg	Copper, Aluminium, Lead, Tin, Zinc, Cadmium, Ferro-alloys, Nickel, Cobalt, Other non-ferrous metals: BAT 11	Continuous or once per year ⁽¹⁾	EN 14884 EN 13211
SO ₂	Copper: BAT 49 Aluminium: BAT 60, BAT 69 Lead, Tin: BAT 100 Precious metals: BAT 142, BAT 143 Nickel, Cobalt: BAT 174 Other non-ferrous metals ⁽⁶⁾⁽⁷⁾	Continuous or once per year ⁽¹⁾⁽⁴⁾	EN 14791
	Zinc, Cadmium: BAT 120	Continuous	
	Carbon/graphite: BAT 182	Once per year	
NO _x , expressed as NO ₂	Copper, Aluminium, Lead, Tin, FeSi, Si (pyrometallurgical processes): BAT 13 Precious metals: BAT 141 Other non-ferrous metals ⁽⁷⁾	Continuous or once per year ⁽¹⁾	EN 14792
	Carbon/graphite	Once per year	
TVOC	Copper: BAT 46 Aluminium: BAT 83 Lead, Tin: BAT 98 Zinc, Cadmium: BAT 123 Other non-ferrous metals ⁽⁸⁾	Continuous or once per year ⁽¹⁾	EN 12619
	Ferro-alloys: BAT 160 Carbon/graphite: BAT 183	Once per year	
Formaldehyde	Carbon/graphite: BAT 183	Once per year	No EN standard available
Phenol	Carbon/graphite: BAT 183	Once per year	No EN standard available
PCDD/F	Copper: BAT 48 Aluminium: BAT 83 Lead, Tin: BAT 99 Zinc, Cadmium: BAT 123 Precious metals: BAT 146 Ferro-alloys: BAT 159 Other non-ferrous metals ⁽⁵⁾⁽⁷⁾	Once per year	EN 1948 parts 1, 2 and 3
H ₂ SO ₄	Copper: BAT 50 Zinc, Cadmium: BAT 114	Once per year	No EN standard available
NH ₃	Aluminium: BAT 89 Precious metals: BAT 145 Nickel, Cobalt: BAT 175	Once per year	No EN standard available
Benzo-[a]-pyrene	Aluminium: BAT 59, BAT 60, BAT 61 Ferro-alloys: BAT 160 Carbon/graphite: BAT 178, BAT 179, BAT 180, BAT 181	Once per year	ISO 11338-1 ISO 11338-2
Gaseous fluorides, expressed as HF	Aluminium: BAT 60, BAT 61, BAT 67	Continuous ⁽¹⁾	ISO 15713

Parameter	Monitoring associated with	Minimum monitoring frequency	Standard(s)
	Aluminium: BAT 60, BAT 67, BAT 84 Zinc, Cadmium: BAT 124	Once per year ⁽¹⁾	
Total fluorides	Aluminium: BAT 60, BAT 67	Once per year	No EN standard available
Gaseous chlorides, expressed as HCl	Aluminium: BAT 84	Continuous or once per year ⁽¹⁾	EN 1911
	Zinc, Cadmium: BAT 124 Precious metals: BAT 144	Once per year	
Cl ₂	Aluminium: BAT 84 Precious metals: BAT 144 Nickel, Cobalt: BAT 172	Once per year	No EN standard available
H ₂ S	Aluminium: BAT 89	Once per year	No EN standard available
PH ₃	Aluminium: BAT 89	Once per year	No EN standard available
Sum of AsH ₃ and SbH ₃	Zinc, Cadmium: BAT 114	Once per year	No EN standard available

Note: 'other non-ferrous metals' means the production of non-ferrous metals other than those dealt with specifically in Sections 11.2 to 11.8.

⁽¹⁾ For sources of high emissions, BAT is continuous measurement or, where continuous measurement is not applicable, more frequent periodic monitoring.

⁽²⁾ For small sources (< 10 000 Nm³/h) of dust emissions from the storage and handling of raw materials, monitoring could be based on the measurement of surrogate parameters (such as the pressure drop).

⁽³⁾ The metals to be monitored depend on the composition of the raw materials used.

⁽⁴⁾ Related to BAT 69(a), a mass balance can be used to calculate SO₂ emissions, based on the measurement of the sulphur content of each of the anode batches consumed.

⁽⁵⁾ Where relevant in view of factors such as the halogenated organic compounds content of the raw materials used, the temperature profile, etc.

⁽⁶⁾ Monitoring is relevant when the raw materials contain sulphur.

⁽⁷⁾ Monitoring may not be relevant for hydrometallurgical processes.

⁽⁸⁾ Where relevant in view of the organic compounds content of the raw materials used.

11.1.6 Mercury emissions

BAT 11. In order to reduce mercury emissions to air (other than those that are routed to the sulphuric acid plant) from a pyrometallurgical process, BAT is to use one or both of the techniques given below.

Technique	
a	Use raw materials with a low mercury content, including by cooperating with providers in order to remove mercury from secondary materials
b	Use of adsorbents (e.g. activated carbon, selenium) in combination with dust filtration ⁽¹⁾

⁽¹⁾ Descriptions of the techniques are given in Section 11.10.

BAT-associated emission levels: See Table 11.1.

Table 11.1: BAT-associated emission levels for mercury emissions to air (other than those that are routed to the sulphuric acid plant) from a pyrometallurgical process using raw materials containing mercury

Parameter	BAT-AEL (mg/Nm ³) ⁽¹⁾ ⁽²⁾
Mercury and its compounds, expressed as Hg	0.01–0.05
⁽¹⁾ As a daily average or as an average over the sampling period.	
⁽²⁾ The lower end of the range is associated with the use of adsorbents (e.g. activated carbon, selenium) in combination with dust filtration, except for processes using Waelz kilns.	

The associated monitoring is in BAT 10.

11.1.7 Sulphur dioxide emissions

BAT 12. In order to reduce emissions of SO₂ from off-gases with a high SO₂ content and to avoid the generation of waste from the flue-gas cleaning system, BAT is to recover sulphur by producing sulphuric acid or liquid SO₂.

Applicability

Only applicable to plants producing copper, lead, primary zinc, silver, nickel and/or molybdenum.

11.1.8 NO_x emissions

BAT 13. In order to prevent NO_x emissions to air from a pyrometallurgical process, BAT is to use one of the techniques given below.

	Technique ⁽¹⁾
a	Low-NO _x burners
b	Oxy-fuel burners
c	Flue-gas recirculation (back through the burner to reduce the temperature of the flame) in the case of oxy-fuel burners
⁽¹⁾ Descriptions of the techniques are given in Section 11.10.	

The associated monitoring is in BAT 10.

11.1.9 Emissions to water, including their monitoring

BAT 14. In order to prevent or reduce the generation of waste water, BAT is to use one or a combination of the techniques given below.

	Technique	Applicability
a	Measure the amount of fresh water used and the amount of waste water discharged	Generally applicable
b	Reuse waste water from cleaning operations (including anode and cathode rinse water) and spills in the same process	Generally applicable
c	Reuse weak acid streams generated in a wet ESP and wet scrubbers	Applicability may be restricted depending on the metal and solid content of the waste water
d	Reuse waste water from slag granulation	Applicability may be restricted depending on the metal and solid content of the waste water
e	Reuse surface run-off water	Generally applicable
f	Use a closed circuit cooling system	Applicability may be restricted when a low temperature is required for process reasons
g	Reuse treated water from the waste water treatment plant	Applicability may be restricted by the salt content

BAT 15. In order to prevent the contamination of water and to reduce emissions to water, BAT is to segregate uncontaminated waste water streams from waste water streams requiring treatment.

Applicability

The segregation of uncontaminated rainwater may not be applicable in the case of existing waste water collection systems.

BAT 16. BAT is to use ISO 5667 for water sampling and to monitor the emissions to water at the point where the emission leaves the installation at least once per month ⁽¹⁾ and in accordance with EN standards. If EN standards are not available, BAT is to use ISO, national or other international standards that ensure the provision of data of an equivalent scientific quality.

⁽¹⁾ The monitoring frequency may be adapted if the data series clearly demonstrate sufficient stability of the emissions.

Parameter	Applicable for the production of ⁽¹⁾	Standard(s)
Mercury (Hg)	Copper, Lead, Tin, Zinc, Cadmium, Precious metals, Ferro-alloys, Nickel, Cobalt, and other non-ferrous metals	EN ISO 17852, EN ISO 12846
Iron (Fe)	Copper, Lead, Tin, Zinc, Cadmium, Precious metals, Ferro-alloys, Nickel, Cobalt, and other non-ferrous metals	EN ISO 11885 EN ISO 15586 EN ISO 17294-2
Arsenic (As)	Copper, Lead, Tin, Zinc, Cadmium, Precious metals, Ferro-alloys, Nickel, and Cobalt	
Cadmium (Cd)		
Copper (Cu)		
Nickel (Ni)		
Lead (Pb)		
Zinc (Zn)		
Silver (Ag)		
Aluminium (Al)	Aluminium	
Cobalt (Co)	Nickel, and Cobalt	
Chromium total (Cr)	Ferro-alloys	
Chromium(VI) (Cr(VI))	Ferro-alloys	EN ISO 10304-3 EN ISO 23913
Antimony (Sb)	Copper, Lead, and Tin	EN ISO 11885 EN ISO 15586 EN ISO 17294-2
Tin (Sn)	Copper, Lead, and Tin	
Other metals, if relevant ⁽²⁾	Aluminium, Ferro-alloys, and other non-ferrous metals	
Sulphate (SO ₄ ²⁻)	Copper, Lead, Tin, Zinc, Cadmium, Precious metals, Nickel, Cobalt, and other non-ferrous metals	EN ISO 10304-1
Fluoride (F)	Primary aluminium	
Total suspended solids (TSS)	Aluminium	EN 872
⁽¹⁾ Note: 'other non-ferrous metals' means the production of non-ferrous metals other than those dealt with specifically in Sections 11.2 to 11.8. ⁽²⁾ The metals monitored depend on the composition of the raw material used.		

BAT 17. In order to reduce emissions to water, BAT is to treat the leakages from the storage of liquids and the waste water from non-ferrous metals production, including from the washing stage in the Waelz kiln process, and to remove metals and sulphates by using a combination of the techniques given below.

Technique ⁽¹⁾		Applicability
a	Chemical precipitation	Generally applicable
b	Sedimentation	Generally applicable
c	Filtration	Generally applicable
d	Flotation	Generally applicable
e	Ultrafiltration	Only applicable to specific streams in non-ferrous metals production
f	Activated carbon filtration	Generally applicable
g	Reverse osmosis	Only applicable to specific streams in non-ferrous metals production

⁽¹⁾ Descriptions of the techniques are given in Section 11.10.

BAT-associated emission levels

The BAT-associated emission levels (BAT-AELs) for direct emissions to a receiving water body from the production of copper, lead, tin, zinc, cadmium, precious metals, nickel, cobalt and ferro-alloys are given in Table 11.2.

These BAT-AELs apply at the point where the emission leaves the installation.

Table 11.2: BAT-associated emission levels for direct emissions to a receiving water body from the production of copper, lead, tin, zinc (including the waste water from the washing stage in the Waelz kiln process), cadmium, precious metals, nickel, cobalt and ferro-alloys

BAT-AEL (mg/l) (daily average)						
Parameter	Production of					
	Copper	Lead and/or Tin	Zinc and/or Cadmium	Precious metals	Nickel and/or Cobalt	Ferro-alloys
Silver (Ag)	NR		≤ 0.6	NR		
Arsenic (As)	≤ 0.1 ⁽¹⁾	≤ 0.1	≤ 0.1	≤ 0.1	≤ 0.3	≤ 0.1
Cadmium (Cd)	0.02–0.1	≤ 0.1	≤ 0.1	≤ 0.05	≤ 0.1	≤ 0.05
Cobalt (Co)	NR	≤ 0.1	NR		0.1–0.5	NR
Chromium total (Cr)	NR					≤ 0.2
Chromium (VI) (Cr(VI))	NR					≤ 0.05
Copper (Cu)	0.05–0.5	≤ 0.2	≤ 0.1	≤ 0.3	≤ 0.5	≤ 0.5
Mercury (Hg)	0.005–0.02	≤ 0.05	≤ 0.05	≤ 0.05	≤ 0.05	≤ 0.05
Nickel (Ni)	≤ 0.5	≤ 0.5	≤ 0.1	≤ 0.5	≤ 2	≤ 2
Lead (Pb)	≤ 0.5	≤ 0.5	≤ 0.2	≤ 0.5	≤ 0.5	≤ 0.2
Zinc (Zn)	≤ 1	≤ 1	≤ 1	≤ 0.4	≤ 1	≤ 1

NR: Not relevant
⁽¹⁾ In the case of a high arsenic content in the total input of the plant, the BAT-AEL may be up to 0.2 mg/l.

The associated monitoring is in BAT 16.

11.1.10 Noise

BAT 18. In order to reduce noise emissions, BAT is to use one or a combination of the techniques given below.

Technique	
a	Use embankments to screen the source of noise
b	Enclose noisy plants or components in sound-absorbing structures
c	Use anti-vibration supports and interconnections for equipment
d	Orientation of noise-emitting machinery
e	Change the frequency of the sound

11.1.11 Odour

BAT 19. In order to reduce odour emissions, BAT is to use one or a combination of the techniques given below.

Technique		Applicability
a	Appropriate storage and handling of odorous materials	Generally applicable
b	Minimise the use of odorous materials	Generally applicable
c	Careful design, operation and maintenance of any equipment that could generate odour emissions	Generally applicable
d	Afterburner or filtration techniques, including biofilters	Applicable only in limited cases (e.g. in the impregnation stage during speciality production in the carbon and graphite sector)

11.2 BAT conclusions for copper production

11.2.1 Secondary materials

BAT 20. In order to increase the secondary materials' recovery yield from scrap, BAT is to separate non-metallic constituents and metals other than copper by using one or a combination of the techniques given below.

	Technique
a	Manual separation of large visible constituents
b	Magnetic separation of ferrous metals
c	Optical or eddy current separation of aluminium
d	Relative density separation of different metallic and non-metallic constituents (using a fluid with a different density or air)

11.2.2 Energy

BAT 21. In order to use energy efficiently in primary copper production, BAT is to use one or a combination of the techniques given below.

	Technique	Applicability
a	Optimise the use of the energy contained in the concentrate using a flash smelting furnace	Only applicable for new plants and for major upgrades of existing plants
b	Use the hot process gases from the melting stages to heat up the furnace charge	Only applicable to shaft furnaces
c	Cover the concentrates during transport and storage	Generally applicable
d	Use the excess heat produced during the primary smelting or converting stages to melt secondary materials containing copper	Generally applicable
e	Use the heat in the gases from anode furnaces in a cascade for other processes such as drying	Generally applicable

BAT 22. In order to use energy efficiently in secondary copper production, BAT is to use one or a combination of the techniques given below.

	Technique	Applicability
a	Reduce the water content of the feed material	Applicability is limited when the moisture content of the materials is used as a technique to reduce diffuse emissions
b	Produce steam by recovering excess heat from the smelting furnace to heat up the electrolyte in refineries and/or to produce electricity in a co-generation installation	Applicable if an economically viable demand of steam exists
c	Melt scraps using the excess heat that is produced during the smelting or converting process	Generally applicable
d	Holding furnace between processing stages	Only applicable for batch-wise operated smelters where a buffer capacity of molten material is required
e	Preheat the furnace charge using the hot process gases from the melting stages	Only applicable to shaft furnaces

BAT 23. In order to use energy efficiently in electrorefining and electrowinning operations, BAT is to use a combination of the techniques given below.

Technique		Applicability
a	Apply insulation and covers to electrolysis tanks	Generally applicable
b	Addition of surfactants to the electrowinning cells	Generally applicable
c	Improved cell design for lower energy consumption by optimisation of the following parameters: space between anode and cathode, anode geometry, current density, electrolyte composition and temperature	Only applicable for new plants and for major upgrades of existing plants
d	Use of stainless steel cathode blanks	Only applicable for new plants and for major upgrades of existing plants
e	Automatic cathode/anode changes to achieve an accurate placement of the electrodes into the cell	Only applicable for new plants and for major upgrades of existing plants
f	Short circuit detection and quality control to ensure that electrodes are straight and flat and that the anode is exact in weight	Generally applicable

11.2.3 Air emissions

BAT 24. In order to reduce secondary emissions to air from furnaces and auxiliary devices in primary copper production and to optimise the performance of the abatement system, BAT is to collect, mix and treat secondary emissions in a centralised off-gas cleaning system.

Description

Secondary emissions from various sources are collected, mixed, and treated in a single centralised off-gas cleaning system, designed to effectively treat the pollutants present in each of the flows. Care is taken not to mix streams which are not chemically compatible and to avoid undesirable chemical reactions among the different collected flows.

Applicability

The applicability may be limited for existing plants by their design and layout.

11.2.3.1 Diffuse emissions

BAT 25. In order to prevent or reduce diffuse emissions from pretreatment (such as blending, drying, mixing, homogenisation, screening and pelletisation) of primary and secondary materials, BAT is to use one or a combination of the techniques given below.

Technique		Applicability
a	Use enclosed conveyers or pneumatic transfer systems for dusty materials	Generally applicable
b	Carry out activities with dusty materials such as mixing in an enclosed building	For existing plants, application may be difficult due to the space requirements
c	Use dust suppression systems such as water cannons or water sprinklers	Not applicable for mixing operations carried out indoors. Not applicable for processes that require dry materials. The application is also limited in regions with water shortages or with very low temperatures
d	Use enclosed equipment for operations with dusty material (such as drying, mixing, milling, air separation and pelletisation) with an air extraction system connected to an abatement system	Generally applicable
e	Use an extraction system for dusty and gaseous emissions, such as a hood in combination with a dust and gas abatement system	Generally applicable

BAT 26. In order to prevent or reduce diffuse emissions from charging, smelting and tapping operations in primary and secondary copper smelters and from holding and melting furnaces, BAT is to use a combination of the techniques given below.

	Technique	Applicability
a	Briquetting and pelletisation of raw materials	Applicable only when the process and the furnace can use pelletised raw materials
b	Enclosed charging system such as single jet burner, door sealing ⁽¹⁾ , closed conveyers or feeders equipped with an air extraction system in combination with a dust and gas abatement system	The jet burner is applicable only for flash furnaces
c	Operate the furnace and gas route under negative pressure and at a sufficient gas extraction rate to prevent pressurisation	Generally applicable
d	Capture hood/enclosures at charging and tapping points in combination with an off-gas abatement system (e.g. housing/tunnel for ladle operation during tapping, and which is closed with a movable door/barrier equipped with a ventilation and abatement system)	Generally applicable
e	Encapsulate the furnace in vented housing	Generally applicable
f	Maintain furnace sealing	Generally applicable
g	Hold the temperature in the furnace at the lowest required level	Generally applicable
h	Boosted suction systems ⁽¹⁾	Generally applicable
i	Enclosed building in combination with other techniques to collect the diffuse emissions	Generally applicable
j	Double bell charging system for shaft/blast furnaces	Generally applicable
k	Select and feed the raw materials according to the type of furnace and abatement techniques used	Generally applicable
l	Use of lids on throats of rotary anode furnace	Generally applicable

⁽¹⁾ Description of the technique is given in Section 11.10.

BAT 27. In order to reduce diffuse emissions from Peirce-Smith converter (PS) furnace in primary and secondary copper production, BAT is to use a combination of the techniques given below.

	Technique
a	Operate the furnace and gas route under negative pressure and at a sufficient gas extraction rate to prevent pressurisation
b	Oxygen enrichment
c	Primary hood over the converter opening to collect and transfer the primary emissions to an abatement system
d	Addition of materials (e.g. scrap and flux) through the hood
e	System of secondary hoods in addition to the main one to capture emissions during charging and tapping operations
f	Furnace located in enclosed building
g	Apply motor-driven secondary hoods, to move them according to the process stage, to increase the efficiency of the collection of secondary emissions
h	Boosted suction systems ⁽¹⁾ and automatic control to prevent blowing when the converter is 'rolled out' or 'rolled in'

⁽¹⁾ Description of the technique is given in Section 11.10.

BAT 28. In order to reduce diffuse emissions from a Hoboken converter furnace in primary copper production, BAT is to use a combination of the techniques given below.

	Technique
a	Operate furnace and gas route under negative pressure during charging, skimming and tapping operations
b	Oxygen enrichment
c	Mouth with closed lids during operation
d	Boosted suction systems ⁽¹⁾
⁽¹⁾ Description of the technique is given in Section 11.10.	

BAT 29. In order to reduce diffuse emissions from the matte conversion process, BAT is to use a flash converting furnace.

Applicability

Applicable only to new plants or major upgrades of existing plants.

BAT 30. In order to reduce diffuse emissions from a top-blown rotary converter (TBRC) furnace in secondary copper production, BAT is to use a combination of the techniques given below.

	Technique	Applicability
a	Operate the furnace and gas route under negative pressure and at a sufficient gas extraction rate to prevent pressurisation	Generally applicable
b	Oxygen enrichment	Generally applicable
c	Furnace located in enclosed building in combination with techniques to collect and transfer diffuse emissions from charging and tapping to an abatement system	Generally applicable
d	Primary hood over the converter opening to collect and transfer the primary emissions to an abatement system	Generally applicable
e	Hoods or crane integrated hood to collect and transfer the emissions from charging and tapping operations to an abatement system	For existing plants, a crane integrated hood is only applicable to major upgrades of the furnace hall
f	Addition of materials (e.g. scrap and flux) through the hood	Generally applicable
g	Boosted suction system ⁽¹⁾	Generally applicable
⁽¹⁾ Description of the technique is given in Section 11.10.		

BAT 31. In order to reduce diffuse emissions from copper recovery with a slag concentrator, BAT is to use the techniques given below.

	Technique
a	Dust suppression techniques such as a water spray for handling, storage and crushing of slag
b	Grinding and flotation performed with water
c	Delivery of the slag to the final storage area via hydro transport in a closed pipeline
d	Maintain a water layer in the pond or use a dust suppressant such as lime milk in dry areas

BAT 32. In order to reduce diffuse emissions from copper-rich slag furnace treatment, BAT is to use a combination of the techniques given below.

	Technique
a	Dust suppression techniques such as a water spray for handling, storage and crushing of the final slag
b	Operation of the furnace under negative pressure
c	Enclosed furnace
d	Housing, enclosure and hood to collect and transfer the emissions to an abatement system
e	Covered launder

BAT 33. In order to reduce diffuse emissions from anode casting in primary and secondary copper production, BAT is to use one or a combination of the techniques given below.

	Technique
a	Use an enclosed tundish
b	Use a closed intermediate ladle
c	Use a hood, equipped with an extraction system, over the casting ladle and over the casting wheel

BAT 34. In order to reduce diffuse emissions from electrolysis cells, BAT is to use one or a combination of the techniques given below.

	Technique	Applicability
a	Addition of surfactants to the electrowinning cells	Generally applicable
b	Use covers or a hood to collect and transfer the emissions to an abatement system	Only applicable for electrowinning cells or refining cells for low-purity anodes. Not applicable when the cell needs to remain uncovered to maintain the cell temperature at workable levels (approximately 65 °C)
c	Closed and fixed pipelines for transferring the electrolyte solutions	Generally applicable
d	Gas extraction from the washing chambers of the cathode stripping machine and anode scrap washing machine	Generally applicable

BAT 35. In order to reduce diffuse emissions from the casting of copper alloys, BAT is to use one or a combination of the techniques given below.

	Technique
a	Use enclosures or hoods to collect and transfer the emissions to an abatement system
b	Use covering for the melts in holding and casting furnaces
c	Boosted suction system ⁽¹⁾
⁽¹⁾ Description of the technique is given in Section 11.10.	

BAT 36. In order to reduce diffuse emissions from non-acid and acid pickling, BAT is to use one of the techniques given below.

	Technique	Applicability
a	Encapsulate the pickling line with a solution of isopropanol operating in a closed circuit	Only applicable for pickling of copper wire rod in continuous operations
b	Encapsulate the pickling line to collect and transfer the emissions to an abatement system	Only applicable for acid pickling in continuous operations

11.2.3.2 Channelled dust emissions

Descriptions of the techniques mentioned in this Section are given in Section 11.10.

The BAT-associated emission levels are all given in Table 11.3.

BAT 37. In order to reduce dust and metal emissions to air from the reception, storage, handling, transport, metering, mixing, blending, crushing, drying, cutting and screening of raw materials, and the pyrolytic treatment of copper turnings in primary and secondary copper production, BAT is to use a bag filter.

BAT 38. In order to reduce dust and metal emissions to air from concentrate drying in primary copper production, BAT is to use a bag filter.

Applicability

In the event of a high organic carbon content in the concentrates (e.g. around 10 wt-%), bag filters may not be applicable (due to blinding of the bags) and other techniques (e.g. ESP) may be used.

BAT 39. In order to reduce dust and metal emissions to air (other than those that are routed to the sulphuric acid or liquid SO₂ plant or power plant) from the primary copper smelter and converter, BAT is to use a bag filter and/or a wet scrubber.

BAT 40. In order to reduce dust and metal emissions to air (other than those that are routed to the sulphuric acid plant) from the secondary copper smelter and converter and from the processing of secondary copper intermediates, BAT is to use a bag filter.

BAT 41. In order to reduce dust and metal emissions to air from the secondary copper holding furnace, BAT is to use a bag filter.

BAT 42. In order to reduce dust and metal emissions to air from copper-rich slag furnace processing, BAT is to use a bag filter or a scrubber in combination with an ESP.

BAT 43. In order to reduce dust and metal emissions to air from the anode furnace in primary and secondary copper production, BAT is to use a bag filter or a scrubber in combination with an ESP.

BAT 44. In order to reduce dust and metal emissions to air from anode casting in primary and secondary copper production, BAT is to use a bag filter or, in the case of off-gases with a water content close to the dew point, a wet scrubber or a demister.

BAT 45. In order to reduce dust and metal emissions to air from a copper melting furnace, BAT is to select and feed the raw materials according to the furnace type and the abatement system used and to use a bag filter.

Table 11.3: BAT-associated emission levels for dust emissions to air from copper production

Parameter	BAT	Process	BAT-AEL (mg/Nm ³)
Dust	BAT 37	Reception, storage, handling, transport, metering, mixing, blending, crushing, drying, cutting and screening of raw materials, and the pyrolytic treatment of copper turnings in primary and secondary copper production	2–5 ⁽¹⁾ ⁽⁴⁾
	BAT 38	Concentrate drying in primary copper production	3–5 ⁽²⁾ ⁽⁴⁾ ⁽⁵⁾
	BAT 39	Primary copper smelter and converter (emissions other than those that are routed to the sulphuric acid or liquid SO ₂ plant or power plant)	2–5 ⁽³⁾ ⁽⁴⁾
	BAT 40	Secondary copper smelter and converter and processing of secondary copper intermediates (emissions other than those that are routed to the sulphuric acid plant)	2–4 ⁽²⁾ ⁽⁴⁾
	BAT 41	Secondary copper holding furnace	≤ 5 ⁽¹⁾
	BAT 42	Copper-rich slag furnace processing	2–5 ⁽¹⁾ ⁽⁶⁾
	BAT 43	Anode furnace (in primary and secondary copper production)	2–5 ⁽²⁾ ⁽⁴⁾
	BAT 44	Anode casting (in primary and secondary copper production)	≤ 5–15 ⁽²⁾ ⁽⁷⁾
	BAT 45	Copper melting furnace	2–5 ⁽²⁾ ⁽⁸⁾

⁽¹⁾ As an average over the sampling period.
⁽²⁾ As a daily average or as an average over the sampling period.
⁽³⁾ As a daily average.
⁽⁴⁾ Dust emissions are expected to be towards the lower end of the range when emissions of heavy metals are above the following levels: 1 mg/Nm³ for lead, 1 mg/Nm³ for copper, 0.05 mg/Nm³ for arsenic, 0.05 mg/Nm³ for cadmium.
⁽⁵⁾ When the concentrates used have a high organic carbon content (e.g. around 10 wt-%), emissions of up to 10 mg/Nm³ can be expected.
⁽⁶⁾ Dust emissions are expected to be towards the lower end of the range when emissions of lead are above 1 mg/Nm³.
⁽⁷⁾ The lower end of the range is associated with the use of a bag filter.
⁽⁸⁾ Dust emissions are expected to be towards the lower end of the range when emissions of copper are above 1 mg/Nm³.

The associated monitoring is in BAT 10.

11.2.3.3 Organic compound emissions

BAT 46. In order to reduce organic compound emissions to air from the pyrolytic treatment of copper turnings, and the drying, smelting and melting of secondary raw materials, BAT is to use one of the techniques given below.

	Technique ⁽¹⁾	Applicability
a	Afterburner or post-combustion chamber or regenerative thermal oxidiser	The applicability is restricted by the energy content of the off-gases that need to be treated, as off-gases with a lower energy content require a higher fuel use
b	Injection of adsorbent in combination with a bag filter	Generally applicable
c	Design of furnace and the abatement techniques according to the raw materials available	Only applicable to new furnaces or major upgrades of existing furnaces
d	Select and feed the raw materials according to the furnace and the abatement techniques used	Generally applicable
e	Thermal destruction of TVOC at high temperatures in the furnace (> 1000 °C)	Generally applicable

⁽¹⁾ Descriptions of the techniques are given in Section 11.10.

BAT-associated emission levels: See Table 11.4.

Table 11.4: BAT-associated emission levels for emissions to air of TVOC from the pyrolytic treatment of copper turnings, and the drying, smelting and melting of secondary raw materials

Parameter	BAT-AEL (mg/Nm ³) ⁽¹⁾ ⁽²⁾
TVOC	3–30

⁽¹⁾ As a daily average or as an average over the sampling period.
⁽²⁾ The lower end of the range is associated with the use of a regenerative thermal oxidiser.

The associated monitoring is in BAT 10.

BAT 47. In order to reduce organic compound emissions to air from solvent extraction in hydrometallurgical copper production, BAT is to use both of the techniques given below and to determine the VOC emissions annually, e.g. through mass balance.

	Technique
a	Process reagent (solvent) with lower steam pressure
b	Closed equipment such as closed mixing tanks, closed settlers and closed storage tanks

BAT 48. In order to reduce PCDD/F emissions to air from the pyrolytic treatment of copper turnings, smelting, melting, fire refining and converting operations in secondary copper production, BAT is to use one or a combination of the techniques given below.

	Technique
a	Select and feed the raw materials according to the furnace and the abatement techniques used
b	Optimise combustion conditions to reduce the emissions of organic compounds
c	Use charging systems, for a semi-closed furnace, to give small additions of raw material
d	Thermal destruction of PCDD/F in the furnace at high temperatures (> 850 °C)
e	Use oxygen injection in the upper zone of the furnace
f	Internal burner system
g	Post-combustion chamber or afterburner or regenerative thermal oxidiser ⁽¹⁾
h	Avoid exhaust systems with a high dust build-up for temperatures > 250 °C
i	Rapid quenching ⁽¹⁾
j	Injection of adsorption agent in combination with an efficient dust collection system ⁽¹⁾
⁽¹⁾ Descriptions of the techniques are given in Section 11.10.	

BAT-associated emission levels: See Table 11.5.

Table 11.5: BAT-associated emission levels for PCDD/F emissions to air from the pyrolytic treatment of copper turnings, smelting, melting, fire refining and converting operations in secondary copper production

Parameter	BAT-AEL (ng I-TEQ/Nm ³) ⁽¹⁾
PCDD/F	≤ 0.1
⁽¹⁾ As an average over a sampling period of at least six hours.	

The associated monitoring is in BAT 10.

11.2.3.4 Sulphur dioxide emissions

Descriptions of the techniques mentioned in this section are given in Section 11.10.

BAT 49. In order to reduce SO₂ emissions (other than those that are routed to the sulphuric acid or liquid SO₂ plant or power plant) from primary and secondary copper production, BAT is to use one or a combination of the techniques given below.

	Technique	Applicability
a	Dry or semi-dry scrubber	Generally applicable
b	Wet scrubber	Applicability may be limited in the following cases: - very high off-gas flow rates (due to the significant amounts of waste and waste water generated) - in arid areas (due to the large volume of water necessary and the need for waste water treatment)
c	Polyether-based absorption/desorption system	Not applicable in the case of secondary copper production. Not applicable in the absence of a sulphuric acid or liquid SO ₂ plant

BAT-associated emission levels: See Table 11.6.

Table 11.6: BAT-associated emission levels for SO₂ emissions to air (other than those that are routed to the sulphuric acid or liquid SO₂ plant or power plant) from primary and secondary copper production

Parameter	Process	BAT-AEL (mg/Nm ³) ⁽¹⁾
SO ₂	Primary copper production	50–500 ⁽²⁾
	Secondary copper production	50–300
⁽¹⁾ As a daily average or as an average over the sampling period.		
⁽²⁾ In the case of using a wet scrubber or a concentrate with a low sulphur content, the BAT-AEL can be up to 350 mg/Nm ³ .		

The associated monitoring is in BAT 10.

11.2.3.5 Acid emissions

BAT 50. In order to reduce acid gas emissions to air from exhaust gases from the electrowinning cells, the electrorefining cells, the washing chamber of the cathode stripping machine and the anode scrap washing machine, BAT is to use a wet scrubber or a demister.

11.2.4 Soil and groundwater

BAT 51. In order to prevent soil and groundwater contamination from copper recovery in the slag concentrator, BAT is to use a drainage system in cooling areas and a correct design of the final slag storage area to collect overflow water and avoid fluid leakage.

BAT 52. In order to prevent soil and groundwater contamination from the electrolysis in primary and secondary copper production, BAT is to use a combination of the techniques given below.

	Technique
a	Use of a sealed drainage system
b	Use of impermeable and acid-resistant floors
c	Use of double-walled tanks or placement in resistant bunds with impermeable floors

11.2.5 Waste water generation

BAT 53. In order to prevent the generation of waste water from primary and secondary copper production, BAT is to use one or a combination of the techniques given below.

	Technique
a	Use the steam condensate for heating the electrolysis cells, to wash the copper cathodes or send it back to steam boiler
b	Reuse the water collected from the cooling area, flotation process and hydro transportation of final slag in the slag concentration process
c	Recycle the pickling solutions and the rinse water
d	Treat the residues (crude) from the solvent extraction step in hydrometallurgical copper production to recover the organic solution content
e	Centrifuge the slurry from cleaning and settlers from the solvent extraction step in hydrometallurgical copper production
f	Reuse the electrolysis bleed after the metal removal stage in the electrowinning and/or the leaching process

11.2.6 Waste

BAT 54. In order to reduce the quantities of waste sent for disposal from primary and secondary copper production, BAT is to organise operations so as to facilitate process residues reuse or, failing that, process residues recycling, including by using one or a combination of the techniques given below.

	Technique	Applicability
a	Recover metals from the dust and slime coming from the dust abatement system	Generally applicable
b	Reuse or sell the calcium compounds (e.g. gypsum) generated by the abatement of SO ₂	Applicability may be restricted depending on the metal content and on the availability of a market
c	Regenerate or recycle the spent catalysts	Generally applicable
d	Recover metal from the waste water treatment slime	Applicability may be restricted depending on the metal content and on the availability of a market/process
e	Use weak acid in the leaching process or for gypsum production	Generally applicable
f	Recover the copper content from the rich slag in the slag furnace or slag flotation plant	
g	Use the final slag from furnaces as an abrasive or (road) construction material or for another viable application	Applicability may be restricted depending on the metal content and on the availability of a market
h	Use the furnace lining for recovery of metals or reuse as refractory material	
i	Use the slag from the slag flotation as an abrasive or construction material or for another viable application	
j	Use the skimming from the melting furnaces to recover the metal content	Generally applicable
k	Use the spent electrolyte bleed to recover copper and nickel. Reuse the remaining acid to make up the new electrolyte or to produce gypsum	
l	Use the spent anode as a cooling material in pyrometallurgical copper refining or remelting	
m	Use anode slime to recover precious metals	
n	Use the gypsum from the waste water treatment plant in the pyrometallurgical process or for sale	Applicability may be restricted depending on the quality of the generated gypsum
o	Recover metals from sludge	Generally applicable
p	Reuse the depleted electrolyte from the hydrometallurgical copper process as a leaching agent	Applicability may be restricted depending on the metal content and on the availability of a market/process
q	Recycle copper scales from rolling in a copper smelter	Generally applicable
r	Recover metals from the spent acid pickling solution and reuse the cleaned acid solution	

11.3 BAT conclusions for aluminium production including alumina and anode production

11.3.1 Alumina production

11.3.1.1 Energy

BAT 55. In order to use energy efficiently during the production of alumina from bauxite, BAT is to use one or a combination of the techniques given below.

	Technique	Description	Applicability
a	Plate heat exchangers	Plate heat exchangers allow a higher heat recovery from the liquor flowing to the precipitation area in comparison with other techniques such as flash cooling plants	Applicable if the energy from the cooling fluid can be reused in the process and if the condensate balance and the liquor conditions allow it
b	Circulating fluidised bed calciners	Circulating fluidised bed calciners have a much higher energy efficiency than rotary kilns, since the heat recovery from the alumina and the flue-gas is greater	Only applicable to smelter-grade aluminas. Not applicable to speciality/non-smelter-grade aluminas, as these require a higher level of calcination that can currently only be achieved with a rotary kiln
c	Single stream digestion design	The slurry is heated up in one circuit without using live steam and therefore without dilution of the slurry (in contrast to the double-stream digestion design)	Only applicable to new plants
d	Selection of the bauxite	Bauxite with a higher moisture content carries more water into the process, which increases the energy need for evaporation. In addition, bauxites with a high monohydrate content (boehmite and/or diaspore) require a higher pressure and temperature in the digestion process, leading to higher energy consumption	Applicable within the constraints related to the specific design of the plant, since some plants are specifically designed for a certain quality of bauxite, which limits the use of alternative bauxite sources

11.3.1.2 Air emissions

BAT 56. In order to reduce dust and metal emissions from alumina calcination, BAT is to use a bag filter or an ESP.

11.3.1.3 Waste

BAT 57. In order to reduce the quantities of waste sent for disposal and to improve the disposal of bauxite residues from alumina production, BAT is to use one or both of the techniques given below.

Technique	
a	Reduce the volume of bauxite residues by compacting in order to minimise the moisture content, e.g. using vacuum or high-pressure filters to form a semi-dry cake
b	Reduce/minimise the alkalinity remaining in the bauxite residues in order to allow disposal of the residues in a landfill

11.3.2 Anode production

11.3.2.1 Air emissions

11.3.2.1.1 Dust, PAH and fluoride emissions from the paste plant

BAT 58. In order to reduce dust emissions to air from a paste plant (removing coke dust from operations such as coke storage and grinding), BAT is to use a bag filter.

BAT-associated emission levels: See Table 11.7.

BAT 59. In order to reduce dust and PAH emissions to air from a paste plant (hot pitch storage, paste mixing, cooling and forming), BAT is to use one or a combination of the techniques given below.

Technique ⁽¹⁾	
a	Dry scrubber using coke as the adsorbent agent, with or without precooling, followed by a bag filter
b	Regenerative thermal oxidiser
c	Catalytic thermal oxidiser
⁽¹⁾ Descriptions of the techniques are given in Section 11.10.	

BAT-associated emission levels: See Table 11.7.

Table 11.7: BAT-associated emission levels for dust and BaP (as an indicator of PAH) emissions to air from a paste plant

Parameter	Process	BAT-AEL (mg/Nm ³)
Dust	- Hot pitch storage, paste mixing, cooling and forming - Removing coke dust from operations such as coke storage and grinding	2–5 ⁽¹⁾
BaP	Hot pitch storage, paste mixing, cooling and forming	0.001–0.01 ⁽²⁾
⁽¹⁾ As a daily average or as an average over the sampling period.		
⁽²⁾ As an average over the sampling period.		

The associated monitoring is in BAT 10.

11.3.2.1.2 Dust, sulphur dioxide, PAH and fluoride emissions from the baking plant

BAT 60. In order to reduce dust, sulphur dioxide, PAH and fluoride emissions to air from a baking plant in an anode production plant integrated with a primary aluminium smelter, BAT is to use one or a combination of the techniques given below.

	Technique ⁽¹⁾	Applicability
a	Use of raw materials and fuels containing a low amount of sulphur	Generally applicable for reducing SO ₂ emissions
b	Dry scrubber using alumina as the adsorbent agent followed by a bag filter	Generally applicable for reducing dust, PAH and fluoride emissions
c	Wet scrubber	Applicability for reducing dust, SO ₂ , PAH and fluoride emissions may be limited in the following cases: - very high off-gas flow rates (due to the significant amounts of waste and waste water generated) - in arid areas (due to the large volume of water necessary and the need for waste water treatment)
d	Regenerative thermal oxidiser in combination with a dust abatement system	Generally applicable for reducing dust and PAH emissions.
⁽¹⁾ Descriptions of the techniques are given in Section 11.10.		

BAT-associated emission levels: See Table 11.8.

Table 11.8: BAT-associated emission levels for dust, BaP (as an indicator of PAH) and fluoride emissions to air from a baking plant in an anode production plant integrated with a primary aluminium smelter

Parameter	BAT-AEL (mg/Nm ³)
Dust	2–5 ⁽¹⁾
BaP	0.001–0.01 ⁽²⁾
HF	0.3–0.5 ⁽¹⁾
Total fluorides	≤ 0.8 ⁽²⁾
⁽¹⁾ As a daily average or as an average over the sampling period.	
⁽²⁾ As an average over the sampling period.	

The associated monitoring is in BAT 10.

BAT 61. In order to reduce dust, PAH and fluoride emissions to air from a baking plant in a stand-alone anode production plant, BAT is to use a pre-filtration unit and a regenerative thermal oxidiser followed by a dry scrubber (e.g. lime bed).

BAT-associated emission levels: See Table 11.9.

Table 11.9: BAT-associated emission levels for dust, BaP (as an indicator of PAH) and fluoride emissions to air from a baking plant in a stand-alone anode production plant

Parameter	BAT-AEL (mg/Nm ³)
Dust	2–5 ⁽¹⁾
BaP	0.001–0.01 ⁽²⁾
HF	≤ 3 ⁽¹⁾
⁽¹⁾ As a daily average.	
⁽²⁾ As an average over the sampling period.	

The associated monitoring is in BAT 10.

11.3.2.2 Waste water generation

BAT 62. In order to prevent the generation of waste water from anode baking, BAT is to use a closed water cycle.

Applicability

Generally applicable to new plants and major upgrades. The applicability may be limited due to water quality and/or product quality requirements.

11.3.2.3 Waste

BAT 63. In order to reduce the quantities of waste sent for disposal, BAT is to recycle carbon dust from the coke filter as a scrubbing medium.

Applicability

There may be restrictions on applicability depending on the ash content of the carbon dust.

11.3.3 Primary aluminium production

11.3.3.1 Air emissions

BAT 64. In order to prevent or collect diffuse emissions from electrolytic cells in primary aluminium production using the Söderberg technology, BAT is to use a combination of the techniques given below.

	Technique
a	Use of paste with a pitch content between 25 % and 28 % (dry paste)
b	Upgrade the manifold design to allow closed point feeding operations and improved off-gas collection efficiency
c	Alumina point feeding
d	Increased anode height combined with the treatment in BAT 67
e	Anode top hooding when high current density anodes are used, connected to the treatment in BAT 67

Description

BAT 64(c): Point feeding of alumina avoids the regular crust-breaking (such as during manual side feed or bar broken feed), and thus reduces the associated fluoride and dust emissions.

BAT 64(d): An increased anode height helps to achieve lower temperatures in the anode top, resulting in lower emissions to air.

BAT-associated emission levels: See Table 11.12.

BAT 65. In order to prevent or collect diffuse emissions from electrolytic cells in primary aluminium production using prebaked anodes, BAT is to use a combination of the techniques given below.

	Technique
a	Automatic multiple point feeding of alumina
b	Complete hood coverage of the cell and adequate off-gas extraction rates (to lead the off-gas to the treatment in BAT 67) taking into account fluoride generation from bath and carbon anode consumption
c	Boosted suction system connected to the abatement techniques listed in BAT 67
d	Minimisation of the time for changing anodes and other activities that require cell hoods to be removed
e	Efficient process control system avoiding process deviations that might otherwise lead to increased cell evolution and emissions
f	Use of a programmed system for cell operations and maintenance
g	Use of established efficient cleaning methods in the rodding plant to recover fluorides and carbon
h	Storage of removed anodes in a compartment near the cell, connected to the treatment in BAT 67, or storage of the butts in confined boxes

Applicability

BAT 65.c and h are not applicable to existing plants.

BAT-associated emission levels: See Table 11.12.

11.3.3.1.1 Channelled dust and fluoride emissions

BAT 66. In order to reduce dust emissions from the storage, handling and transport of raw materials, BAT is to use a bag filter.

BAT-associated emission levels: See Table 11.10.

Table 11.10: BAT-associated emission levels for dust from the storage, handling and transport of raw materials

Parameter	BAT-AEL (mg/Nm³)⁽¹⁾
Dust	≤ 5–10
⁽¹⁾ As an average over the sampling period.	

The associated monitoring is in BAT 10.

BAT 67. In order to reduce dust, metal and fluoride emissions to air from electrolytic cells, BAT is to use one of the techniques given below.

	Technique ⁽¹⁾	Applicability
a	Dry scrubber using alumina as the adsorbent agent followed by a bag filter	Generally applicable
b	Dry scrubber using alumina as the adsorbent agent followed by a bag filter and a wet scrubber	Applicability may be limited in the following cases: - very high off-gas flow rates (due to the significant amounts of waste and waste water generated) - in arid areas (due to the large volume of water necessary and the need for waste water treatment)
⁽¹⁾ Descriptions of the techniques are given in Section 11.10		

BAT-associated emission levels: See Table 11.11 and Table 11.12.

Table 11.11: BAT-associated emission levels for dust and fluoride emissions to air from electrolytic cells

Parameter	BAT-AEL (mg/Nm ³)
Dust	2–5 ⁽¹⁾
HF	≤ 1.0 ⁽¹⁾
Total fluorides	≤ 1.5 ⁽²⁾
⁽¹⁾ As a daily average or as an average over the sampling period.	
⁽²⁾ As an average over the sampling period.	

The associated monitoring is in BAT 10.

11.3.3.1.2 Total emissions of dust and fluorides

BAT-associated emission levels for the total emissions of dust and fluoride to air from the electrolysis house (collected from the electrolytic cells and roof vents): See Table 11.12.

Table 11.12: BAT-associated emission levels for the total emissions of dust and fluoride to air from the electrolysis house (collected from the electrolytic cells and roof vents)

Parameter	BAT	BAT-AELs for existing plants (kg/t Al) ⁽¹⁾ ⁽²⁾	BAT-AELs for new plants (kg/t Al) ⁽¹⁾
Dust	Combination of BAT 64, BAT 65 and BAT 67	≤ 1.2	≤ 0.6
Total fluorides		≤ 0.6	≤ 0.35
⁽¹⁾ As mass of pollutant emitted during a year from the electrolysis house divided by the mass of liquid aluminium produced in the same year.			
⁽²⁾ These BAT-AELs are not applicable to plants that due to their configuration cannot measure roof emissions.			

The associated monitoring is in BAT 10.

BAT 68. In order to prevent or reduce dust and metal emissions to air from melting and molten metal treatment and casting in primary aluminium production, BAT is to use one or both of the techniques given below.

	Technique
a	Use of liquid metal from electrolysis and uncontaminated aluminium material, i.e. solid material free of substances such as paint, plastic or oil (e.g. the top and the bottom part of the billets that are cut for quality reasons)
b	Bag filter ⁽¹⁾
⁽¹⁾ Description of the technique is given in Section 11.10.	

BAT-associated emission levels: See Table 11.13.

Table 11.13: BAT-associated emission levels for dust emissions to air from melting and molten metal treatment and casting in primary aluminium production

Parameter	BAT-AEL (mg/Nm ³) ⁽¹⁾ ⁽²⁾
Dust	2–25
⁽¹⁾ As an average of the samples obtained over a year.	
⁽²⁾ The lower end of the range is associated with the use of a bag filter.	

The associated monitoring is in BAT 10.

11.3.3.1.3 Sulphur dioxide emissions

BAT 69. In order to reduce emissions to air from electrolytic cells, BAT is to use one or both of the techniques given below.

	Technique	Applicability
a	Use of low-sulphur anodes	Generally applicable
b	Wet scrubber ⁽¹⁾	Applicability may be limited in the following cases: - very high off-gas flow rates (due to the significant amounts of waste and waste water generated) - in arid areas (due to the large volume of water necessary and the need for waste water treatment)
⁽¹⁾ Description of the technique is given in Section 11.10.		

Description

BAT 69(a): Anodes containing less than 1.5 % sulphur as a yearly average can be produced by an appropriate combination of the raw materials used. A minimum sulphur content of 0.9 % as a yearly average is required for the viability of the electrolytic process.

BAT-associated emission levels: See Table 11.14.

Table 11.14: BAT-associated emission levels for SO₂ emissions to air from electrolytic cells

Parameter	BAT-AEL (kg/t Al) ⁽¹⁾ ⁽²⁾
SO ₂	≤ 2.5–15
⁽¹⁾ As mass of pollutant emitted during a year divided by the mass of liquid aluminium produced in the same year.	
⁽²⁾ The lower end of the range is associated with the use of a wet scrubber. The higher end of the range is associated with the use of low-sulphur anodes.	

The associated monitoring is in BAT 10.

11.3.3.1.4 Perfluorocarbon emissions

BAT 70. In order to reduce perfluorocarbon emissions to air from primary aluminium production, BAT is to use all of the techniques given below.

	Technique	Applicability
a	Automatic multiple point feeding of alumina	Generally applicable
b	Computer control of the electrolysis process based on active cell databases and monitoring of cell operating parameters	Generally applicable
c	Automatic anode effect suppression	Not applicable to Söderberg cells because the anode design (one piece only) does not allow the bath flow associated with this technique

Description

BAT 70(c): The anode effect takes place when the alumina content of the electrolyte falls below 1–2 %. During anode effects, instead of decomposing alumina, the cryolite bath is decomposed into metal and fluoride ions, the latter forming gaseous perfluorocarbons, which react with the carbon anode.

11.3.3.1.5 PAH and CO emissions

BAT 71. In order to reduce CO and PAH emissions to air from primary aluminium production using the Söderberg technology, BAT is to combust the CO and the PAH in the cell exhaust gas.

11.3.3.2 Waste water generation

BAT 72. In order to prevent the generation of waste water, BAT is to reuse or recycle cooling water and treated waste water, including rainwater, within the process.

Applicability

Generally applicable to new plants and major upgrades. The applicability may be limited due to water quality and/or product quality requirements. The amount of cooling water, treated waste water and rainwater that is reused or recycled cannot be higher than the amount of water needed for the process.

11.3.3.3 Waste

BAT 73. In order to reduce the disposal of spent pot lining, BAT is to organise operations on site so as to facilitate its external recycling, such as in cement manufacturing in the salt slag recovery process, as a carburiser in the steel or ferro-alloy industry or as a secondary raw material (e.g. rock wool), depending on the end consumer's requirements.

11.3.4 Secondary aluminium production

11.3.4.1 Secondary materials

BAT 74. In order to increase the raw materials' yield, BAT is to separate non-metallic constituents and metals other than aluminium by using one or a combination of the techniques given below depending on the constituents of the treated materials.

	Technique
a	Magnetic separation of ferrous metals
b	Eddy current separation (using moving electromagnetic fields) of aluminium from the other constituents
c	Relative density separation (using a fluid with a different density) of different metals and non-metallic constituents

11.3.4.2 Energy

BAT 75. In order to use energy efficiently, BAT is to use one or a combination of the techniques given below.

	Technique	Applicability
a	Preheating of the furnace charge with the exhaust gas	Only applicable for non-rotating furnaces
b	Recirculation of the gases with unburnt hydrocarbons back into the burner system	Only applicable for reverberatory furnaces and dryers
c	Supply the liquid metal for direct moulding	Applicability is limited by the time needed for the transportation (maximum 4–5 hours)

11.3.4.3 Air emissions

BAT 76. In order to prevent or reduce emissions to air, BAT is to remove oil and organic compounds from the swarf before the smelting stage using centrifugation and/or drying ⁽¹⁾.

⁽¹⁾ Description of the techniques are given in Section 11.10.

Applicability

Centrifugation is only applicable to highly oil-contaminated swarf, when it is applied before the drying. The removal of oil and organic compounds may not be needed if the furnace and the abatement system are designed to handle the organic material.

11.3.4.3.1 Diffuse emissions

BAT 77. In order to prevent or reduce diffuse emissions from the pretreatment of scraps, BAT is to use one or both of the techniques given below.

	Technique
a	Closed or pneumatic conveyor, with an air extraction system
b	Enclosures or hoods for the charging and for the discharge points, with an air extraction system

BAT 78. In order to prevent or reduce diffuse emissions from the charging and discharging/tapping of melting furnaces, BAT is to use one or a combination of the techniques given below.

	Technique	Applicability
a	Placing a hood on top of the furnace door and at the taphole with off-gas extraction connected to a filtration system	Generally applicable
b	Fume collection enclosure that covers both the charging and tapping zones	Only applicable for stationary drum furnaces
c	Sealed furnace door ⁽¹⁾	Generally applicable
d	Sealed charging carriage	Only applicable for non-rotating furnaces
e	Boosted suction system that can be modified according to the process needed ⁽¹⁾	Generally applicable
⁽¹⁾ Description of the technique is given in Section 11.10.		

Description

BAT 78(a) and (b): Consist of applying a covering with extraction to collect and handle the off-gases from the process.

BAT 78(d): The skip seals against the open furnace door during the discharge of scrap and maintains furnace sealing during this stage.

BAT 79. In order to reduce emissions from skimmings/dross treatment, BAT is to use one or a combination of the techniques given below.

	Technique
a	Cooling of skimmings/dross, as soon as they are skimmed from the furnace, in sealed containers under inert gas
b	Prevention of wetting of the skimmings/dross
c	Compaction of skimmings/dross with an air extraction and dust abatement system

11.3.4.3.2 Channelled dust emissions

BAT 80. In order to reduce dust and metal emissions from the swarf drying and the removal of oil and organic compounds from the swarf, from the crushing, milling and dry separation of non-metallic constituents and metals other than aluminium, and from the storage, handling and transport in secondary aluminium production, BAT is to use a bag filter.

BAT-associated emission levels: See Table 11.15.

Table 11.15: BAT-associated emission levels for dust emissions to air from the swarf drying and the removal of oil and organic compounds from the swarf, from the crushing, milling and dry separation of non-metallic constituents and metals other than aluminium, and from the storage, handling and transport in secondary aluminium production

Parameter	BAT-AEL (mg/Nm ³) ⁽¹⁾
Dust	≤ 5
⁽¹⁾ As an average over the sampling period.	

The associated monitoring is in BAT 10.

BAT 81. In order to reduce dust and metal emissions to air from furnace processes such as charging, melting, tapping and molten metal treatment in secondary aluminium production, BAT is to use a bag filter.

BAT-associated emission levels: See Table 11.16.

Table 11.16: BAT-associated emission levels for dust emissions to air from furnace processes such as charging, melting, tapping and molten metal treatment in secondary aluminium production

Parameter	BAT-AEL (mg/Nm ³) ⁽¹⁾
Dust	2–5

⁽¹⁾ As a daily average or as an average over the sampling period.

The associated monitoring is in BAT 10.

BAT 82. In order to reduce dust and metal emissions to air from remelting in secondary aluminium production, BAT is to use one or a combination of the techniques given below.

	Technique
a	Use of uncontaminated aluminium material i.e. solid material free of substances such as paint, plastic or oil (e.g. billets)
b	Optimise combustion conditions to reduce the emissions of dust
c	Bag filter

BAT-associated emission levels: See Table 11.17.

Table 11.17: BAT-associated emission levels for dust from remelting in secondary aluminium production

Parameter	BAT-AEL (mg/Nm ³) ⁽¹⁾ ⁽²⁾
Dust	2–5

⁽¹⁾ As an average over the sampling period.

⁽²⁾ For furnaces designed to use and using only uncontaminated raw material, for which dust emissions are below 1 kg/h, the upper end of the range is 25 mg/Nm³ as an average of the samples obtained over a year.

The associated monitoring is in BAT 10.

11.3.4.3.3 Organic compound emissions

BAT 83. In order to reduce emissions to air of organic compounds and PCDD/F from the thermal treatment of contaminated secondary raw materials (e.g. swarf) and from the melting furnace, BAT is to use a bag filter in combination with at least one of the techniques given below.

	Technique ⁽¹⁾
a	Select and feed the raw materials according to the furnace and the abatement techniques used
b	Internal burner system for melting furnace
c	Afterburner
d	Rapid quenching
e	Activated carbon injection

⁽¹⁾ Descriptions of the techniques are given in Section 11.10.

BAT-associated emission levels: See Table 11.18.

Table 11.18: BAT-associated emission levels for emissions to air of TVOC and PCDD/F from the thermal treatment of contaminated secondary raw materials (e.g. swarf) and from the melting furnace

Parameter	Unit	BAT-AEL
TVOC	mg/Nm ³	≤ 10–30 ⁽¹⁾
PCDD/F	ng I-TEQ/Nm ³	≤ 0.1 ⁽²⁾
⁽¹⁾ As a daily average or as an average over the sampling period.		
⁽²⁾ As an average over a sampling period of at least six hours.		

The associated monitoring is in BAT 10.

11.3.4.3.4 Acid emissions

BAT 84. In order to reduce emissions to air of HCl, Cl₂ and HF from the thermal treatment of contaminated secondary raw materials (e.g. swarf), the melting furnace, and remelting and molten metal treatment, BAT is to use one or a combination of the techniques given below.

	Technique
a	Select and feed the raw materials according to the furnace and the abatement techniques used ⁽¹⁾
b	Ca(OH) ₂ or sodium bicarbonate injection in combination with a bag filter ⁽¹⁾
c	Control of the refining process, adapting the quantity of refining gas used to remove the contaminants present into the molten metals
d	Use of dilute chlorine with inert gas in the refining process
⁽¹⁾ Description of the techniques are given in Section 11.10.	

Description

BAT 84(d): Using chlorine diluted with inert gas instead of only pure chlorine, to reduce the emission of chlorine. Refining can also be performed using only the inert gas.

BAT-associated emission levels: See Table 11.19.

Table 11.19: BAT-associated emission levels for HCl, Cl₂ and HF emissions to air from the thermal treatment of contaminated secondary raw materials (e.g. swarf), the melting furnace, and remelting and molten metal treatment

Parameter	BAT-AEL (mg/Nm ³)
HCl	≤ 5–10 ⁽¹⁾
Cl ₂	≤ 1 ⁽²⁾ ⁽³⁾
HF	≤ 1 ⁽⁴⁾
⁽¹⁾ As a daily average or as an average over the sampling period. For refining carried out with chemicals containing chlorine, the BAT-AEL refers to the average concentration during chlorination.	
⁽²⁾ As an average over the sampling period. For refining carried out with chemicals containing chlorine, the BAT-AEL refers to the average concentration during chlorination.	
⁽³⁾ Only applicable to emissions from refining processes carried out with chemicals containing chlorine.	
⁽⁴⁾ As an average over the sampling period.	

The associated monitoring is in BAT 10.

11.3.4.4 Waste

BAT 85. In order to reduce the quantities of waste sent for disposal from secondary aluminium production, BAT is to organise operations on site so as to facilitate process residues reuse or, failing that, process residues recycling, including by using one or a combination of the techniques given below.

	Technique
a	Reuse collected dust in the process in the case of a melting furnace using salt cover or in the salt slag recovery process
b	Full recycling of the salt slag
c	Apply skimmings/dross treatment to recover aluminium in the case of furnaces that do not use salt cover

BAT 86. In order to reduce the quantities of salt slag produced from secondary aluminium production, BAT is to use one or a combination of the techniques given below.

	Technique	Applicability
a	Increase the quality of raw material used through the separation of the non-metallic constituents and metals other than aluminium for scraps where aluminium is mixed with other constituents	Generally applicable
b	Remove oil and organic constituents from contaminated swarf before melting	Generally applicable
c	Metal pumping or stirring	Not applicable for rotary furnaces
d	Tilting rotary furnace	There may be restrictions on the use of this furnace due to the size of the feed materials

11.3.5 Salt slag recycling process

11.3.5.1 Diffuse emissions

BAT 87. In order to prevent or reduce diffuse emissions from the salt slag recycling process, BAT is to use one or both of the techniques given below.

	Technique
a	Enclose equipment with gas extraction connected to a filtration system
b	Hood with gas extraction connected to a filtration system

11.3.5.2 Channelled dust emissions

BAT 88. In order to reduce dust and metal emissions to air from crushing and dry milling associated with the salt slag recovery process, BAT is to use a bag filter.

BAT-associated emission levels: See Table 11.20

Table 11.20: BAT-associated emission levels for dust emissions to air from crushing and dry milling associated with the salt slag recovery process

Parameter	BAT-AEL (mg/Nm ³) ⁽¹⁾
Dust	2–5

⁽¹⁾ As a daily average or as an average over the sampling period.

The associated monitoring is in BAT 10.

11.3.5.3 Gaseous compounds

BAT 89. In order to reduce gaseous emissions to air from wet milling and leaching from the salt slag recovery process, BAT is to use one or a combination of the techniques given below.

	Technique ⁽¹⁾
a	Activated carbon injection
b	Afterburner
c	Wet scrubber with H ₂ SO ₄ solution
⁽¹⁾ Descriptions of the techniques are given in Section 11.10.	

BAT-associated emission levels: See Table 11.21.

Table 11.21: BAT-associated emission levels for gaseous emissions to air from wet milling and leaching from the salt slag recovery process

Parameter	BAT-AEL (mg/Nm ³) ⁽¹⁾
NH ₃	≤ 10
PH ₃	≤ 0.5
H ₂ S	≤ 2
⁽¹⁾ As an average over the sampling period.	

The associated monitoring is in BAT 10.

11.4 BAT conclusions for lead and/or tin production

11.4.1 Air emissions

11.4.1.1 Diffuse emissions

BAT 90. In order to prevent or reduce diffuse emissions from preparation (such as metering, mixing, blending, crushing, cutting, screening) of primary and secondary materials (excluding batteries), BAT is to use one or a combination of the techniques given below.

	Technique	Applicability
a	Enclosed conveyer or pneumatic transfer system for dusty material	Generally applicable
b	Enclosed equipment. When dusty materials are used the emissions are collected and sent to an abatement system	Only applicable for feed blends prepared with a dosing bin or loss-in-weight system
c	Mixing of raw materials carried out in an enclosed building	Only applicable for dusty materials. For existing plants, application may be difficult due to the space required
d	Dust suppression systems such as water sprays	Only applicable for mixing carried out outdoors
e	Pelletisation of raw materials	Applicable only when the process and the furnace can use pelletised raw materials

BAT 91. In order to prevent or reduce diffuse emissions from material pretreatment (such as drying, dismantling, sintering, briquetting, pelletising and battery crushing, screening and classifying) in primary lead and secondary lead and/or tin production, BAT is to use one or both of the techniques given below.

	Technique
a	Enclosed conveyer or pneumatic transfer system for dusty material
b	Enclosed equipment. When dusty materials are used the emissions are collected and sent to an abatement system

BAT 92. In order to prevent or reduce diffuse emissions from charging, smelting and tapping operations in lead and/or tin production, and from pre-decoppering operations in primary lead production, BAT is to use an appropriate combination of the techniques given below.

	Technique	Applicability
a	Encapsulated charging system with an air extraction system	Generally applicable
b	Sealed or enclosed furnaces with door sealing ⁽¹⁾ for processes with a discontinuous feed and output	Generally applicable
c	Operate furnace and gas routes under negative pressure and at a sufficient gas extraction rate to prevent pressurisation	Generally applicable
d	Capture hood/enclosures at charging and tapping points	Generally applicable
e	Enclosed building	Generally applicable
f	Complete hood coverage with an air extraction system	In existing plants or major upgrades of existing plants, application may be difficult due to the space requirements
g	Maintain furnace sealing	Generally applicable
h	Maintain the temperature in the furnace at the lowest required level	Generally applicable
i	Apply a hood at the tapping point, ladles and drossing area with an air extraction system	Generally applicable
j	Pretreatment of dusty raw material, such as pelletisation	Applicable only when the process and the furnace can use pelletised raw materials
k	Apply a doghouse for ladles during tapping	Generally applicable
l	An air extraction system for charging and tapping area connected to a filtration system	Generally applicable
⁽¹⁾ Descriptions of the techniques are given in Section 11.10.		

BAT 93. In order to prevent or reduce diffuse emissions from remelting, refining and casting in primary and secondary lead and/or tin production, BAT is to use a combination of the techniques given below.

	Technique
a	Hood on the crucible furnace or kettle with an air extraction system
b	Lids to close the kettle during the refining reactions and addition of chemicals
c	Hood with air extraction system at launders and tapping points
d	Temperature control of the melt
e	Closed mechanical skimmers for removal of dusty dross/residues

11.4.1.2 Channelled dust emissions

BAT 94. In order to reduce dust and metal emissions to air from raw material preparation (such as reception, handling, storage, metering, mixing, blending, drying, crushing, cutting and screening) in primary and secondary lead and/or tin production, BAT is to use a bag filter.

BAT-associated emission levels: See Table 11.22.

Table 11.22: BAT-associated emission levels for dust emissions to air from raw material preparation in primary and secondary lead and/or tin production

Parameter	BAT-AEL (mg/Nm ³) ⁽¹⁾
Dust	≤ 5
⁽¹⁾ As a daily average or as an average over the sampling period.	

The associated monitoring is in BAT 10.

BAT 95. In order to reduce dust and metal emissions to air from battery preparation (crushing, screening and classifying), BAT is to use a bag filter or a wet scrubber.

BAT-associated emission levels: See Table 11.23.

Table 11.23: BAT-associated emission levels for dust emissions to air from battery preparation (crushing, screening and classifying)

Parameter	BAT-AEL (mg/Nm ³) ⁽¹⁾
Dust	≤ 5
⁽¹⁾ As an average over the sampling period.	

The associated monitoring is in BAT 10.

BAT 96. In order to reduce dust and metal emissions to air (other than those that are routed to the sulphuric acid or liquid SO₂ plant) from charging, smelting and tapping in primary and secondary lead and/or tin production, BAT is to use a bag filter.

BAT-associated emission levels: See Table 11.24.

Table 11.24: BAT-associated emission levels for dust and lead emissions to air (other than those that are routed to the sulphuric acid or liquid SO₂ plant) from charging, smelting and tapping in primary and secondary lead and/or tin production

Parameter	BAT-AEL (mg/Nm ³)
Dust	2–4 ⁽¹⁾⁽²⁾
Pb	≤ 1 ⁽³⁾
⁽¹⁾ As a daily average or as an average over the sampling period.	
⁽²⁾ Dust emissions are expected to be towards the lower end of the range when emissions are above the following levels: 1 mg/Nm ³ for copper, 0.05 mg/Nm ³ for arsenic, 0.05 mg/Nm ³ for cadmium.	
⁽³⁾ As an average over the sampling period.	

The associated monitoring is in BAT 10.

BAT 97. In order to reduce dust and metal emissions to air from remelting, refining and casting in primary and secondary lead and/or tin production, BAT is to use the techniques given below.

	Technique
a	For pyrometallurgical processes: maintain the temperature of the melt bath at the lowest possible level according to the process stage in combination with a bag filter
b	For hydrometallurgical processes: use a wet scrubber

BAT-associated emission levels: See Table 11.25.

Table 11.25: BAT-associated emission levels for dust and lead emissions to air from remelting, refining and casting in primary and secondary lead and/or tin production

Parameter	BAT-AEL (mg/Nm ³)
Dust	2–4 ⁽¹⁾ ⁽²⁾
Pb	≤ 1 ⁽³⁾
⁽¹⁾ As a daily average or as an average over the sampling period. ⁽²⁾ Dust emissions are expected to be towards the lower end of the range when emissions are above the following levels: 1 mg/Nm ³ for copper, 1 mg/Nm ³ for antimony, 0.05 mg/Nm ³ for arsenic, 0.05 mg/Nm ³ for cadmium. ⁽³⁾ As an average over the sampling period.	

The associated monitoring is in BAT 10.

11.4.1.3 Organic compound emissions

BAT 98. In order to reduce emissions of organic compounds to air from the raw material drying and smelting process in secondary lead and/or tin production, BAT is to use one or a combination of the techniques given below.

	Technique ⁽¹⁾	Applicability
a	Select and feed the raw materials according to the furnace and the abatement techniques used	Generally applicable
b	Optimise combustion conditions to reduce the emissions of organic compounds	Generally applicable
c	Afterburner or regenerative thermal oxidiser	The applicability is restricted by the energy content of the off-gases that need to be treated, as off-gases with a lower energy content lead to a higher use of fuels
⁽¹⁾ Descriptions of the techniques are given in Section 11.10.		

BAT-associated emission levels: See Table 11.26.

Table 11.26: BAT-associated emission levels for TVOC emissions to air from the raw material drying and smelting process in secondary lead and/or tin production

Parameter	BAT-AEL (mg/Nm ³) ⁽¹⁾
TVOC	10–40
⁽¹⁾ As a daily average or as an average over the sampling period.	

The associated monitoring is in BAT 10.

BAT 99. In order to reduce PCDD/F emissions to air from the smelting of secondary lead and/or tin raw materials, BAT is to use one or a combination of the techniques given below.

	Technique
a	Select and feed the raw materials according to the furnace and the abatement techniques used ⁽¹⁾
b	Use charging systems, for a semi-closed furnace, to give small additions of raw material ⁽¹⁾
c	Internal burner system ⁽¹⁾ for melting furnaces
d	Afterburner or regenerative thermal oxidiser ⁽¹⁾
e	Avoid exhaust systems with a high dust build-up at temperatures > 250 °C ⁽¹⁾
f	Rapid quenching ⁽¹⁾
g	Injection of adsorption agent in combination with efficient dust collection system ⁽¹⁾
h	Use of efficient dust collection system
i	Use of oxygen injection in the upper zone of the furnace
j	Optimise combustion conditions to reduce the emissions of organic compounds ⁽¹⁾
⁽¹⁾ Descriptions of the techniques are given in Section 11.10.	

BAT-associated emission levels: See Table 11.27.

Table 11.27: BAT-associated emission levels for PCDD/F emissions to air from the smelting of secondary lead and/or tin raw materials

Parameter	BAT-AEL (ng I-TEQ/Nm ³) ⁽¹⁾
PCDD/F	≤ 0.1
⁽¹⁾ As an average over a sampling period of at least six hours.	

The associated monitoring is in BAT 10.

11.4.1.4 Sulphur dioxide emissions

BAT 100. In order to prevent or reduce SO₂ emissions to air (other than those that are routed to the sulphuric acid or liquid SO₂ plant) from charging, smelting and tapping in primary and secondary lead and/or tin production, BAT is to use one or a combination of the techniques given below.

	Technique	Applicability
a	Alkaline leaching of raw materials that contain sulphur in the form of sulphate	Generally applicable
b	Dry or semi-dry scrubber ⁽¹⁾	Generally applicable
c	Wet scrubber ⁽¹⁾	Applicability may be limited in the following cases: - very high off-gas flow rates (due to the significant amounts of waste and waste water generated) - in arid areas (due to the large volume of water necessary and the need for waste water treatment)
d	Fixation of sulphur in the smelt phase	Only applicable for secondary lead production
⁽¹⁾ Descriptions of the techniques are given in Section 11.10.		

Description

BAT 100(a): Alkali salt solution is used to remove sulphates from secondary materials prior to smelting.

BAT 100(d): The fixation of sulphur in the smelt phase is achieved by adding iron and soda (Na₂CO₃) in the smelters which react with the sulphur contained in the raw materials to form Na₂S-FeS slag.

BAT-associated emission levels: See Table 11.28.

Table 11.28: BAT-associated emission levels for SO₂ emissions to air (other than those that are routed to the sulphuric acid or liquid SO₂ plant) from charging, smelting and tapping in primary and secondary lead and/or tin production

Parameter	BAT-AEL (mg/Nm ³) ⁽¹⁾ ⁽²⁾
SO ₂	50–350
⁽¹⁾ As a daily average or as an average over the sampling period.	
⁽²⁾ When wet scrubbers are not applicable, the upper end of the range is 500 mg/Nm ³ .	

The associated monitoring is in BAT 10.

11.4.2 Soil and groundwater protection

BAT 101. In order to prevent the contamination of soil and groundwater from battery storage, crushing, screening and classifying operations, BAT is to use an acid-resistant floor surface and a system for the collection of acid spillages.

11.4.3 Waste water generation and treatment

BAT 102. In order to prevent the generation of waste water from the alkaline leaching process, BAT is to reuse the water from the sodium sulphate crystallisation of the alkali salt solution.

BAT 103. In order to reduce emissions to water from battery preparation when the acid mist is sent to the waste water treatment plant, BAT is to operate an adequately designed waste water treatment plant to abate the pollutants contained in this stream.

11.4.4 Waste

BAT 104. In order to reduce the quantities of waste sent for disposal from primary lead production, BAT is to organise operations on site so as to facilitate process residues reuse or, failing that, process residues recycling, including by using one or a combination of the techniques given below.

	Technique	Applicability
a	Reuse of the dust from the dust removal system in the lead production process	Generally applicable
b	Se and Te recovery from wet or dry gas cleaning dust/sludge	The applicability can be limited by the quantity of mercury present
c	Ag, Au, Bi, Sb and Cu recovery from the refining dross	Generally applicable
d	Recovery of metals from the waste water treatment sludge	Direct smelting of the waste water treatment plant sludge might be limited by the presence elements such as As, Tl and Cd
e	Addition of flux materials that make the slag more suitable for external use	Generally applicable

BAT 105. In order to allow the recovery of the polypropylene and polyethylene content of the lead battery, BAT is to separate it from the batteries prior to smelting.

Applicability

This may not be applicable for shaft furnaces due to the gas permeability provided by undismantled (whole) batteries, which is required by the furnace operations.

BAT 106. In order to reuse or recover the sulphuric acid collected from the battery recovery process, BAT is to organise operations on site so as to facilitate its internal or external reuse or recycling, including one or a combination of the techniques given below.

	Technique	Applicability
a	Reuse as a pickling agent	Generally applicable depending on the local conditions such as presence of the pickling process and compatibility of the impurities present in the acid with the process
b	Reuse as raw material in a chemical plant	Applicability may be restricted depending on the local availability of a chemical plant
c	Regeneration of the acid by cracking	Only applicable when a sulphuric acid or liquid sulphur dioxide plant is present
d	Production of gypsum	Only applicable if the impurities present in the recovery acid do not affect the gypsum quality or if gypsum of a lower quality can be used for other purposes such as a flux agent
e	Production of sodium sulphate	Only applicable for the alkaline leaching process

BAT 107. In order to reduce the quantities of waste sent for disposal from secondary lead and/or tin production, BAT is to organise operations on site so as to facilitate process residues reuse or, failing that, process residues recycling, including by using one or a combination of the techniques given below.

	Technique
a	Reuse the residues in the smelting process to recover lead and other metals
b	Treat the residues and the wastes in dedicated plants for material recovery
c	Treat the residues and the wastes so that they can be used for other applications

11.5 BAT conclusions for zinc and/or cadmium production

11.5.1 Primary zinc production

11.5.1.1 Hydrometallurgical zinc production

11.5.1.1.1 Energy

BAT 108. In order to use energy efficiently, BAT is to recover heat from the off-gases produced in the roaster using one or a combination of the techniques given below.

Technique		Applicability
a	Use a waste heat boiler and turbines to produce electricity	Applicability may be restricted depending on energy prices and the energy policy of the Member State
b	Use a waste heat boiler and turbines to produce mechanical energy to be used within the process	Generally applicable
c	Use a waste heat boiler to produce heat to be used within the process and/or for office heating	Generally applicable

11.5.1.1.2 Air emissions

11.5.1.1.2.1 Diffuse emissions

BAT 109. In order to reduce diffuse dust emissions to air from the roaster feed preparation and the feeding itself, BAT is to use one or both of the techniques given below.

Technique	
a	Wet feeding
b	Completely enclosed process equipment connected to an abatement system

BAT 110. In order to reduce diffuse dust emissions to air from calcine processing, BAT is to use one or both of the techniques given below.

Technique	
a	Perform operations under negative pressure
b	Completely enclosed process equipment connected to an abatement system

BAT 111. In order to reduce diffuse emissions to air from leaching, solid-liquid separation and purification, BAT is to use one or a combination of the techniques given below.

Technique		Applicability
a	Cover tanks with a lid	Generally applicable
b	Cover process liquid inlet and outlet launders	Generally applicable
c	Connect tanks to a central mechanical draught abatement system or to a single tank abatement system	Generally applicable
d	Cover vacuum filters with hoods and connect them to an abatement system	Only applicable to the filtering of hot liquids in the leaching and solid-liquid separation stages

BAT 112. In order to reduce diffuse emissions to air from electrowinning, BAT is to use additives, especially foaming agents, in the electrowinning cells.

11.5.1.1.2.2 Channelled emissions

BAT 113. In order to reduce dust and metal emissions to air from the handling and storage of raw materials, dry roaster feed preparation, dry roaster feeding and calcine processing, BAT is to use a bag filter.

BAT-associated emission levels: See Table 11.29.

Table 11.29: BAT-associated emission levels for dust emissions to air from the handling and storage of raw materials, dry roaster feed preparation, dry roaster feeding and calcine processing

Parameter	BAT-AEL (mg/Nm ³) ⁽¹⁾
Dust	≤ 5
⁽¹⁾ As an average over the sampling period.	

The associated monitoring is in BAT 10.

BAT 114. In order to reduce zinc and sulphuric acid emissions to air from leaching, purification and electrolysis, and to reduce arsane and stibane emissions from purification, BAT is to use one or a combination of the techniques given below.

	Technique ⁽¹⁾
a	Wet scrubber
b	Demister
c	Centrifugal system
⁽¹⁾ Descriptions of the techniques are given in Section 11.10.	

BAT-associated emission levels: See Table 11.30.

Table 11.30: BAT-associated emission levels for zinc and sulphuric acid emissions to air from leaching, purification and electrolysis and for arsane and stibane emissions from purification

Parameter	BAT-AEL (mg/Nm ³) ⁽¹⁾
Zn	≤ 1
H ₂ SO ₄	< 10
Sum of AsH ₃ and SbH ₃	≤ 0.5
⁽¹⁾ As an average over the sampling period.	

The associated monitoring is in BAT 10.

11.5.1.1.3 Soil and groundwater protection

BAT 115. In order to prevent soil and groundwater contamination, BAT is to use a watertight bunded area for tanks used during leaching or purification and a secondary containment system of the cell houses.

11.5.1.1.4 Waste water generation

BAT 116. In order to reduce fresh water consumption and prevent the generation of waste water, BAT is to use a combination of the techniques given below.

	Technique
a	Return of the bleed from the boiler and the water from the closed cooling circuits of the roaster to the wet gas cleaning or the leaching stage
b	Return of the waste water from the cleaning operations/spills of the roaster, the electrolysis and the casting to the leaching stage
c	Return of the waste water from the cleaning operations/spills of the leaching and purification, the filter cake washing and the wet gas scrubbing to the leaching and/or purification stages

11.5.1.1.5 Waste

BAT 117. In order to reduce the quantities of waste sent for disposal, BAT is to organise operations on site so as to facilitate process residues reuse or, failing that, process residues recycling, including by using one or a combination of the techniques given below.

	Technique	Applicability
a	Reuse of the dust collected in the concentrate storage and handling within the process (together with the concentrate feed)	Generally applicable
b	Reuse of the dust collected in the roasting process via the calcine silo	Generally applicable
c	Recycling of residues containing lead and silver as raw material in an external plant	Applicable depending on the metal content and on the availability of a market/process
d	Recycling of residues containing Cu, Co, Ni, Cd, Mn as raw material in an external plant to obtain a saleable product	Applicable depending on the metal content and on the availability of a market/process

BAT 118. In order to make the leaching waste suitable for final disposal, BAT is to use one of the techniques given below.

	Technique	Applicability
a	Pyrometallurgical treatment in a Waelz kiln	Only applicable to neutral leaching wastes that do not contain too many zinc ferrites and/or do not contain high concentrations of precious metals
b	Jarofix process	Only applicable to jarosite iron residues. Limited applicability due to an existing patent
c	Sulphidation process	Only applicable to jarosite iron residues and direct leach residues
d	Compacting iron residues	Only applicable to goethite residues and gypsum-rich sludge from the waste water treatment plant

Description

BAT 118(b): The Jarofix process consists of mixing jarosite precipitates with Portland cement, lime and water.

BAT 118(c): The sulphidation process consists of the addition of NaOH and Na₂S to the residues in an elutriating tank and in sulphidation reactors.

BAT 118(d): Compacting iron residues consists of reducing the moisture content by means of filters and the addition of lime or other agents.

11.5.1.2 Pyrometallurgical zinc production**11.5.1.2.1 Air emissions**

11.5.1.2.1.1 Channelled dust emissions

BAT 119. In order to reduce dust and metal emissions to air (other than those that are routed to the sulphuric acid plant) from pyrometallurgical zinc production, BAT is to use a bag filter.

Applicability

In the event of a high organic carbon content in the concentrates (e.g. around 10 wt-%), bag filters might not be applicable due to the blinding of the bags and other techniques (e.g. wet scrubber) might be used.

BAT-associated emission levels: See Table 11.31.

Table 11.31: BAT-associated emission levels for dust emissions to air (other than those that are routed to the sulphuric acid plant) from pyrometallurgical zinc production

Parameter	BAT-AEL (mg/Nm ³) ⁽¹⁾ ⁽²⁾
Dust	2–5
⁽¹⁾ As a daily average or as an average over the sampling period.	
⁽²⁾ When a bag filter is not applicable, the upper end of the range is 10 mg/Nm ³ .	

The associated monitoring is in BAT 10.

BAT 120. In order to reduce SO₂ emissions to air (other than those that are routed to the sulphuric acid plant) from pyrometallurgical zinc production, BAT is to use a wet desulphurisation technique.

BAT-associated emission levels: See Table 11.32.

Table 11.32: BAT-associated emission levels for SO₂ emissions to air (other than those that are routed to the sulphuric acid plant) from pyrometallurgical zinc production

Parameter	BAT-AEL (mg/Nm ³) ⁽¹⁾
SO ₂	≤ 500
⁽¹⁾ As a daily average.	

The associated monitoring is in BAT 10.

11.5.2 Secondary zinc production**11.5.2.1 Air emissions**

11.5.2.1.1 Channelled dust emissions

BAT 121. In order to reduce dust and metal emissions to air from pelletising and slag processing, BAT is to use a bag filter.

BAT-associated emission levels: See Table 11.33.

Table 11.33: BAT-associated emission levels for dust emissions to air from pelletising and slag processing

Parameter	BAT-AEL (mg/Nm ³) ⁽¹⁾
Dust	≤ 5
⁽¹⁾ As an average over the sampling period.	

The associated monitoring is in BAT 10.

BAT 122. In order to reduce dust and metal emissions to air from the melting of metallic and mixed metallic/oxidic streams, and from the slag fuming furnace and the Waelz kiln, BAT is to use a bag filter.

Applicability

A bag filter may not be applicable for a clinker operation (where chlorides need to be abated instead of metal oxides).

BAT-associated emission levels: See Table 11.34.

Table 11.34: BAT-associated emission levels for dust emissions to air from the melting of metallic and mixed metallic/oxidic streams, and from the slag fuming furnace and the Waelz kiln

Parameter	BAT-AEL (mg/Nm ³) ⁽¹⁾ ⁽²⁾ ⁽³⁾
Dust	2–5
⁽¹⁾ As a daily average or as an average over the sampling period.	
⁽²⁾ When a bag filter is not applicable, the upper end of the range may be higher, up to 15 mg/Nm ³ .	
⁽³⁾ Dust emissions are expected to be towards the lower end of the range when emissions of arsenic or cadmium are above 0.05 mg/Nm ³ .	

The associated monitoring is in BAT 10.

11.5.2.1.2 Organic compound emissions

BAT 123. In order to reduce emissions of organic compounds to air from the melting of metallic and mixed metallic/oxidic streams, and from the slag fuming furnace and the Waelz kiln, BAT is to use one or a combination of the techniques given below.

	Technique ⁽¹⁾	Applicability
a	Injection of adsorbent (activated carbon or lignite coke) followed by a bag filter and/or ESP	Generally applicable
b	Thermal oxidiser	Generally applicable
c	Regenerative thermal oxidiser	May not be applicable due to safety reasons
⁽¹⁾ Descriptions of the techniques are given in Section 11.10.		

BAT-associated emission levels: See Table 11.35.

Table 11.35: BAT-associated emission levels for emissions to air of TVOC and PCDD/F from the melting of metallic and mixed metallic/oxidic streams, and from the slag fuming furnace and the Waelz kiln

Parameter	Unit	BAT-AEL
TVOC	mg/Nm ³	2–20 ⁽¹⁾
PCDD/F	ng I-TEQ/Nm ³	≤ 0.1 ⁽²⁾
⁽¹⁾ As a daily average or as an average over the sampling period.		
⁽²⁾ As an average over a sampling period of at least six hours.		

The associated monitoring is in BAT 10.

11.5.2.1.3 Acid emissions

BAT 124. In order to reduce emissions of HCl and HF to air from the melting of metallic and mixed metallic/oxidic streams, and from the slag fuming furnace and the Waelz kiln, BAT is to use one of the techniques given below.

	Technique ⁽¹⁾	Process
a	Injection of adsorbent followed by a bag filter	- Melting of metallic and mixed metallic/oxidic streams - Waelz kiln
b	Wet scrubber	Slag fuming furnace

⁽¹⁾ Descriptions of the techniques are given in Section 11.10.

BAT-associated emission levels: See Table 11.36.

Table 11.36: BAT-associated emission levels for emissions of HCl and HF to air from the melting of metallic and mixed metallic/oxidic streams, and from the slag fuming furnace and the Waelz kiln

Parameter	BAT-AEL (mg/Nm ³) ⁽¹⁾
HCl	≤ 1.5
HF	≤ 0.3

⁽¹⁾ As an average over the sampling period.

The associated monitoring is in BAT 10.

11.5.2.2 Waste water generation and treatment

BAT 125. In order to reduce the consumption of fresh water in the Waelz kiln process, BAT is to use multiple-stage countercurrent washing.

Description

Water coming from a previous washing stage is filtered and reused in the following washing stage. Two or three stages can be used, allowing up to three times less water consumption in comparison with single-stage countercurrent washing.

BAT 126. In order to prevent or reduce halide emissions to water from the washing stage in the Waelz kiln process, BAT is to use crystallisation.

11.5.3 Melting, alloying and casting of zinc ingots and zinc powder production

11.5.3.1 Air emissions

11.5.3.1.1 Diffuse dust emissions

BAT 127. In order to reduce diffuse dust emissions to air from the melting, alloying and casting of zinc ingots, BAT is to use equipment under negative pressure.

11.5.3.1.2 Channelled dust emissions

BAT 128. In order to reduce dust and metal emissions to air from the melting, alloying and casting of zinc ingots and zinc powder production, BAT is to use a bag filter.

BAT-associated emission levels: See Table 11.37.

Table 11.37: BAT-associated emission levels for dust emissions to air from the melting, alloying and casting of zinc ingots and zinc powder production

Parameter	BAT-AEL (mg/Nm ³) ⁽¹⁾
Dust	≤ 5
⁽¹⁾ As an average over the sampling period.	

The associated monitoring is in BAT 10.

11.5.3.2 Waste water

BAT 129. In order to prevent the generation of waste water from the melting and casting of zinc ingots, BAT is to reuse the cooling water.

11.5.3.3 Waste

BAT 130. In order to reduce the quantities of waste sent for disposal from the melting of zinc ingots, BAT is to organise operations on site so as to facilitate process residues reuse or, failing that, process residues recycling, including by using one or both of the techniques given below.

	Technique
a	Use of the oxidised fraction of the zinc dross and the zinc-bearing dust from the melting furnaces in the roasting furnace or in the hydrometallurgical zinc production process
b	Use of the metallic fraction of the zinc dross and the metallic dross from cathode casting in the melting furnace or recovery as zinc dust or zinc oxide in a zinc refining plant

11.5.4 Cadmium production

11.5.4.1 Air emissions

11.5.4.1.1 Diffuse emissions

BAT 131. In order to reduce diffuse emissions to air, BAT is to use one or both of the techniques given below.

	Technique
a	Central extraction system connected to an abatement system for leaching and solid-liquid separation in hydrometallurgical production; for briquetting/pelletising and fuming in pyrometallurgical production; and for melting, alloying and casting processes
b	Cover cells for the electrolysis stage in hydrometallurgical production

11.5.4.1.2 Channelled dust emissions

BAT 132. In order to reduce dust and metal emissions to air from pyrometallurgical cadmium production and the melting, alloying and casting of cadmium ingots, BAT is to use one or a combination of the techniques given below.

	Technique ⁽¹⁾	Applicability
a	Bag filter	Generally applicable
b	ESP	Generally applicable
c	Wet scrubber	Applicability may be limited in the following cases: - very high off-gas flow rates (due to the significant amounts of waste and waste water generated) - in arid areas (due to the large volume of water necessary and the need for waste water treatment)
⁽¹⁾ Descriptions of the techniques are given in Section 11.10.		

BAT-associated emission levels: See Table 11.38.

Table 11.38: BAT-associated emission levels for dust and cadmium emissions to air from pyrometallurgical cadmium production and the melting, alloying and casting of cadmium ingots

Parameter	BAT-AEL (mg/Nm ³) ⁽¹⁾
Dust	2–3
Cd	≤ 0.1
⁽¹⁾ As an average over the sampling period.	

The associated monitoring is in BAT 10.

11.5.4.2 Waste

BAT 133. In order to reduce the quantities of waste sent for disposal from hydrometallurgical cadmium production, BAT is to organise operations on site so as to facilitate process residues reuse or, failing that, process residues recycling, including by using one of the techniques given below.

	Technique	Applicability
a	Extract the cadmium from the zinc process as a cadmium-rich cementate in the purification section, further concentrate and refine it (by electrolysis or a pyrometallurgical process) and finally transform it into marketable cadmium metal or cadmium compounds	Only applicable if an economically viable demand exists
b	Extract the cadmium from the zinc process as a cadmium-rich cementate in the purification section, and then apply a set of hydrometallurgical operations in order to obtain a cadmium-rich precipitate (e.g. cement (Cd metal), $\text{Cd}(\text{OH})_2$) that is landfilled, while all other process flows are recycled in the cadmium plant or in the zinc plant flow	Only applicable if suitable landfill is available

11.6 BAT conclusions for precious metals production

11.6.1 Air emissions

11.6.1.1 Diffuse emissions

BAT 134. In order to reduce diffuse emissions to air from a pretreatment operation (such as crushing, sieving and mixing), BAT is to use one or a combination of the techniques given below.

	Technique
a	Enclose pretreatment areas and transfer systems for dusty materials
b	Connect pretreatment and handling operations to dust collectors or extractors via hoods and a ductwork system for dusty materials
c	Electrically interlock pretreatment and handling equipment with their dust collector or extractor, in order to ensure that no equipment may be operated unless the dust collector and filtering system are in operation

BAT 135. In order to reduce diffuse emissions to air from smelting and melting (both Doré and non-Doré operations), BAT is to use all of the techniques given below.

	Technique
a	Enclose buildings and/or smelting furnace areas
b	Perform operations under negative pressure
c	Connect furnace operations to dust collectors or extractors via hoods and a ductwork system
d	Electrically interlock furnace equipment with their dust collector or extractor, in order to ensure that no equipment may be operated unless the dust collector and filtering system are in operation

BAT 136. In order to reduce diffuse emissions to air from leaching and gold electrolysis, BAT is to use one or a combination of the techniques given below.

	Technique
a	Closed tanks/vessels and closed pipes for transfer of solutions
b	Hoods and extraction systems for electrolytic cells
c	Water curtain for gold production, to prevent chlorine gas emissions during the leaching of anode slimes with hydrochloric acid or other solvents

BAT 137. In order to reduce diffuse emissions from a hydrometallurgical operation, BAT is to use all of the techniques given below.

	Technique
a	Containment measures, such as sealed or enclosed reaction vessels, storage tanks, solvent extraction equipment and filters, vessels and tanks fitted with level control, closed pipes, sealed drainage systems, and planned maintenance programmes
b	Reaction vessels and tanks connected to a common ductwork system with off-gas extraction (automatic standby/back-up unit available in case of failure)

BAT 138. In order to reduce diffuse emissions to air from incineration, calcining and drying, BAT is to use all of the techniques given below.

Technique	
a	Connect all calcining furnaces, incinerators and drying ovens to a ductwork system extracting process exhaust gases
b	Scrubber plant on a priority electricity circuit which is served by a back-up generator in the event of power failure
c	Operating start-up and shutdown, spent acid disposal, and fresh acid make-up of scrubbers via an automated control system

BAT 139. In order to reduce diffuse emissions to air from the melting of final metal products during refining, BAT is to use both of the techniques given below.

Technique	
a	Enclosed furnace with negative pressure
b	Appropriate housing, enclosures and capture hoods with efficient extraction/ventilation

11.6.1.2 Channelled dust emissions

BAT 140. In order to reduce dust and metal emissions to air from all dusty operations, such as crushing, sieving, mixing, melting, smelting, incineration, calcining, drying and refining, BAT is to use one of the techniques given below.

Technique ⁽¹⁾		Applicability
a	Bag filter	May not be applicable for off-gases containing a high level of volatilised selenium
b	Wet scrubber in combination with an ESP, allowing the recovery of selenium	Only applicable to off-gases containing volatilised selenium (e.g. Doré metal production)

⁽¹⁾ Descriptions of the techniques are given in Section 11.10.

BAT-associated emission levels: See Table 11.39.

Table 11.39: BAT-associated emission levels for dust emissions to air from all dusty operations, such as crushing, sieving, mixing, melting, smelting, incineration, calcining, drying and refining

Parameter	BAT-AEL (mg/Nm ³) ⁽¹⁾
Dust	2–5

⁽¹⁾ As a daily average or as an average over the sampling period.

The associated monitoring is in BAT 10.

11.6.1.3 NO_x emissions

BAT 141. In order to reduce NO_x emissions to air from a hydrometallurgical operation involving dissolving/leaching with nitric acid, BAT is to use one or both of the techniques given below.

Technique ⁽¹⁾	
a	Alkaline scrubber with caustic soda
b	Scrubber with oxidation agents (e.g. oxygen, hydrogen peroxide) and reducing agents (e.g. nitric acid, urea) for those vessels in hydrometallurgical operations with the potential to generate high concentrations of NO _x . It is often applied in combination with BAT 141(a)
⁽¹⁾ Descriptions of the techniques are given in Section 11.10	

BAT-associated emission levels: See Table 11.40.

Table 11.40: BAT-associated emission levels for NO_x emissions to air from a hydrometallurgical operation involving dissolving/leaching with nitric acid

Parameter	BAT-AEL (mg/Nm ³) ⁽¹⁾
NO _x	70–150
⁽¹⁾ As an hourly average or as an average over the sampling period.	

The associated monitoring is in BAT 10.

11.6.1.4 Sulphur dioxide emissions

BAT 142. In order to reduce SO₂ emissions to air (other than those that are routed to the sulphuric acid plant) from a melting and smelting operation for the production of Doré metal, including the associated incineration, calcining and drying operations, BAT is to use one or a combination of the techniques given below.

Technique ⁽¹⁾		Applicability
a	Lime injection in combination with a bag filter	Generally applicable
b	Wet scrubber	Applicability may be limited in the following cases: - very high off-gas flow rates (due to the significant amounts of waste and waste water generated) - in arid areas (due to the large volume of water necessary and the need for waste water treatment)
⁽¹⁾ Descriptions of the techniques are given in Section 11.10.		

BAT-associated emission levels: See Table 11.41.

Table 11.41: BAT-associated emission levels for SO₂ emissions to air (other than those that are routed to the sulphuric acid plant) from a melting and smelting operation for the production of Doré metal, including the associated incineration, calcining and drying operations

Parameter	BAT-AEL (mg/Nm ³) ⁽¹⁾
SO ₂	50–480
⁽¹⁾ As a daily average or as an average over the sampling period.	

The associated monitoring is in BAT 10.

BAT 143. In order to reduce SO₂ emissions to air from a hydrometallurgical operation, including the associated incineration, calcining and drying operations, BAT is to use a wet scrubber.

BAT-associated emission levels: See Table 11.42.

Table 11.42: BAT-associated emission levels for SO₂ emissions to air from a hydrometallurgical operation, including the associated incineration, calcining and drying operations

Parameter	BAT-AEL (mg/Nm ³) ⁽¹⁾
SO ₂	50–100
⁽¹⁾ As a daily average or as an average over the sampling period.	

The associated monitoring is in BAT 10.

11.6.1.5 HCl and Cl₂ emissions

BAT 144. In order to reduce HCl and Cl₂ emissions to air from a hydrometallurgical operation, including the associated incineration, calcining and drying operations, BAT is to use an alkaline scrubber.

BAT-associated emission levels: See Table 11.43.

Table 11.43: BAT-associated emission levels for HCl and Cl₂ emissions to air from a hydrometallurgical operation, including the associated incineration, calcining and drying operations

Parameter	BAT-AEL (mg/Nm ³) ⁽¹⁾
HCl	≤ 5–10
Cl ₂	0.5–2
⁽¹⁾ As an average over the sampling period.	

The associated monitoring is in BAT 10.

11.6.1.6 NH₃ emissions

BAT 145. In order to reduce NH₃ emissions to air from a hydrometallurgical operation using ammonia or ammonium chloride, BAT is to use a wet scrubber with sulphuric acid.

BAT-associated emission levels: See Table 11.44.

Table 11.44: BAT-associated emission levels for NH₃ emissions to air from a hydrometallurgical operation using ammonia or ammonium chloride

Parameter	BAT-AEL (mg/Nm ³) ⁽¹⁾
NH ₃	1–3
⁽¹⁾ As an average over the sampling period.	

The associated monitoring is in BAT 10.

11.6.1.7 PCDD/F emissions

BAT 146. In order to reduce PCDD/F emissions to air from a drying operation where the raw materials contain organic compounds, halogens or other PCDD/F precursors, from an incineration operation, and from a calcining operation, BAT is to use one or a combination of the techniques given below.

	Technique
a	Afterburner or regenerative thermal oxidiser ⁽¹⁾
b	Injection of adsorption agent in combination with an efficient dust collection system ⁽¹⁾
c	Optimise combustion or process conditions for the abatement of emissions of organic compounds ⁽¹⁾
d	Avoid exhaust systems with a high dust build-up for temperatures > 250 °C ⁽¹⁾
e	Rapid quenching ⁽¹⁾
f	Thermal destruction of PCDD/F in the furnace at high temperatures (> 850 °C)
g	Use of oxygen injection in the upper zone of the furnace
h	Internal burner system ⁽¹⁾
⁽¹⁾ Descriptions of the techniques are given in Section 11.10.	

BAT-associated emission levels: See Table 11.45.

Table 11.45: BAT-associated emission levels for PCDD/F emissions to air from a drying operation where the raw materials contain organic compounds, halogens or other PCDD/F precursors, from an incineration operation, and from a calcining operation

Parameter	BAT-AEL (ng I-TEQ/Nm ³) ⁽¹⁾
PCDD/F	≤ 0.1
⁽¹⁾ As an average over a sampling period of at least six hours.	

The associated monitoring is in BAT 10.

11.6.2 Soil and groundwater protection

BAT 147. In order to prevent soil and groundwater contamination, BAT is to use a combination of the techniques given below.

	Technique
a	Use of sealed drainage systems
b	Use of double-walled tanks or placement in resistant bunds
c	Use of impermeable and acid-resistant floors
d	Automatic level control of reaction vessels

11.6.3 Waste water generation

BAT 148. In order to prevent the generation of waste water, BAT is to use one or both of the techniques given below.

	Technique
a	Recycling of spent/recovered scrubbing liquids and other hydrometallurgical reagents in leaching and other refining operations
b	Recycling of solutions from leaching, extraction and precipitation operations

11.6.4 Waste

BAT 149. In order to reduce the quantities of waste sent for disposal, BAT is to organise operations on site so as to facilitate process residues reuse or, failing that, process residues recycling, including by using one or a combination of the techniques given below.

	Technique	Process
a	Recovery of the metal content from slags, filter dust and residues of the wet dedusting system	Doré production
b	Recovery of the selenium collected in the wet dedusting system's off-gases containing volatilised selenium	
c	Recovery of silver from spent electrolyte and spent slime washing solutions	Silver electrolytic refining
d	Recovery of metals from residues from electrolyte purification (e.g. silver cement, copper carbonate-based residue)	
e	Recovery of gold from electrolyte, slimes and solutions from the gold leaching processes	Gold electrolytic refining
f	Recovery of metals from spent anodes	Silver or gold electrolytic refining
g	Recovery of platinum group metals from platinum group metal-enriched solutions	
h	Recovery of metals from the treatment of process end liquors	All processes

11.7 BAT conclusions for ferro-alloys production

11.7.1 Energy

BAT 150. In order to use energy efficiently, BAT is to recover energy from the CO-rich exhaust gas generated in a closed submerged arc furnace or in a closed plasma dust process using one or a combination of the techniques given below.

	Technique	Applicability
a	Use of a steam boiler and turbines to recover the energy content of the exhaust gas and produce electricity	Applicability may be restricted depending on energy prices and the energy policy of the Member State
b	Direct use of the exhaust gas as fuel within the process (e.g. for drying raw materials, preheating charging materials, sintering, heating of ladles)	Only applicable if a demand for process heat exists
c	Use of the exhaust gas as fuel in neighbouring plants	Only applicable if an economically viable demand for this type of fuel exists

BAT 151. In order to use energy efficiently, BAT is to recover energy from the hot exhaust gas generated in a semi-closed submerged arc furnace using one or both of the techniques given below.

	Technique	Applicability
a	Use of a waste heat boiler and turbines to recover the energy content of the exhaust gas and produce electricity	Applicability may be restricted depending on energy prices and the energy policy of the Member State
b	Use of a waste heat boiler to produce hot water	Only applicable if an economically viable demand exists

BAT 152. In order to use energy efficiently, BAT is to recover energy from the exhaust gas generated in an open submerged arc furnace via the production of hot water.

Applicability

Only applicable if an economically viable demand for hot water exists.

11.7.2 Air emissions

11.7.2.1 Diffuse dust emissions

BAT 153. In order to prevent or reduce and collect diffuse emissions to air from tapping and casting, BAT is to use one or both of the techniques given below.

	Technique	Applicability
a	Use of a hooding system	For existing plants, applicable depending on the configuration of the plant
b	Avoid casting by using ferro-alloys in the liquid state	Only applicable when the consumer (e.g. steel producer) is integrated with the ferro-alloy producer

11.7.2.2 Channelled dust emissions

BAT 154. In order to reduce dust and metal emissions to air from the storage, handling and transport of solid materials, and from pretreatment operations such as metering, mixing, blending and degreasing, and from tapping, casting and packaging, BAT is to use a bag filter.

BAT-associated emission levels: See Table 11.46.

BAT 155. In order to reduce dust and metal emissions to air from crushing, briquetting, pelletising and sintering, BAT is to use a bag filter or a bag filter in combination with other techniques.

Applicability

The applicability of a bag filter may be limited in the case of low ambient temperatures (-20 °C to -40 °C) and high humidity of the off-gases, as well as for the crushing of CaSi due to safety concerns (i.e. explosivity).

BAT-associated emission levels: See Table 11.46.

BAT 156. In order to reduce dust and metal emissions to air from an open or a semi-closed submerged arc furnace, BAT is to use a bag filter.

BAT-associated emission levels: See Table 11.46.

BAT 157. In order to reduce dust and metal emissions to air from a closed submerged arc furnace or a closed plasma dust process, BAT is to use one of the techniques given below.

	Technique ⁽¹⁾	Applicability
a	Wet scrubber in combination with an ESP	Generally applicable
b	Bag filter	Generally applicable unless safety concerns exist related to the CO and H ₂ content in the exhaust gases

⁽¹⁾ Descriptions of the techniques are given in Section 11.10.

BAT-associated emission levels: See Table 11.46.

BAT 158. In order to reduce dust and metal emissions to air from a refractory-lined crucible for the production of ferro-molybdenum and ferro-vanadium, BAT is to use a bag filter.

BAT-associated emission levels: See Table 11.46.

Table 11.46: BAT-associated emission levels for dust emissions to air from ferro-alloys production

Parameter	Process	BAT-AEL (mg/Nm ³)
Dust	- Storage, handling and transport of solid materials - Pretreatment operations such as metering, mixing, blending and degreasing - Tapping, casting and packaging	2–5 ⁽¹⁾
	Crushing, briquetting, pelletising and sintering	2–5 ⁽²⁾ ⁽³⁾
	Open or semi-closed submerged arc furnace	2–5 ⁽²⁾ ⁽⁴⁾ ⁽⁵⁾
	- Closed submerged arc furnace or closed plasma dust process - Refractory-lined crucible for the production of ferro-molybdenum and ferro-vanadium	2–5 ⁽²⁾
⁽¹⁾ As an average over the sampling period. ⁽²⁾ As a daily average or as an average over the sampling period. ⁽³⁾ The upper end of the range can be up to 10 mg/Nm ³ for cases where a bag filter cannot be used. ⁽⁴⁾ The upper end of the range may be up to 15 mg/Nm ³ for the production of FeMn, SiMn, CaSi due to the sticky nature of the dust (caused e.g. by its hygroscopic capacity or chemical characteristics) affecting the efficiency of the bag filter. ⁽⁵⁾ Dust emissions are expected to be towards the lower end of the range when emissions of metals are above the following levels: 1 mg/Nm ³ for lead, 0.05 mg/Nm ³ for cadmium, 0.05 mg/Nm ³ for chromium ^{VI} , 0.05 mg/Nm ³ for thallium.		

The associated monitoring is in BAT 10.

11.7.2.3 PCDD/F emissions

BAT 159. In order to reduce PCDD/F emissions to air from a furnace producing ferro-alloys, BAT is to inject adsorbents and to use an ESP and/or a bag filter.

BAT-associated emission levels: See Table 11.47.

Table 11.47: BAT-associated emission levels for PCDD/F emissions to air from a furnace producing ferro-alloys

Parameter	BAT-AEL (ng I-TEQ/Nm ³)
PCDD/F	≤ 0.05 ⁽¹⁾
⁽¹⁾ As an average over a sampling period of at least six hours.	

The associated monitoring is in BAT 10.

11.7.2.4 PAH and organic compound emissions

BAT 160. In order to reduce PAH and organic compound emissions to air from the degreasing of titanium swarf in rotary kilns, BAT is to use a thermal oxidiser.

11.7.3 Waste

BAT 161. In order to reduce the quantities of slag sent for disposal, BAT is to organise operations on site so as to facilitate slag reuse or, failing that, slag recycling, including by using one or a combination of the techniques given below.

	Technique	Applicability
a	Use of slag in construction applications	Only applicable to slags from high-carbon FeCr and SiMn production, slags from alloy recovery from steel mill residues and standard exhaust slag from FeMn and FeMo production
b	Use of slag as sandblasting grit	Only applicable to slags from high-carbon FeCr production
c	Use of slag for refractory castables	Only applicable to slags from high-carbon FeCr production
d	Use of slag in the smelting process	Only applicable to slags from silico-calcium production
e	Use of slag as raw material for the production of silico-manganese or other metallurgical applications	Only applicable to rich slag (high content of MnO) from FeMn production

BAT 162. In order to reduce the quantities of filter dust and sludge sent for disposal, BAT is to organise operations on site so as to facilitate filter dust and sludge reuse or, failing that, filter dust and sludge recycling, including one or a combination of the techniques given below.

	Technique	Applicability ⁽¹⁾
a	Use of filter dust in the smelting process	Only applicable to filter dust from FeCr and FeMo production
b	Use of filter dust in stainless steel production	Only applicable to filter dust from crushing and screening operations in high-carbon FeCr production
c	Use of filter dust and sludge as a concentrate feed	Only applicable to filter dust and sludge from the off-gas cleaning in Mo roasting
d	Use of filter dust in other industries	Only applicable to FeMn, SiMn, FeNi, FeMo and FeV production
e	Use of micro-silica as an additive in the cement industry	Only applicable to micro-silica from FeSi and Si production
f	Use of filter dust and sludge in the zinc industry	Only applicable to furnace dust and wet scrubber sludge from the alloy recovery from steel mill residues

⁽¹⁾ Highly contaminated dusts and sludges cannot be reused or recycled. Reuse and recycling might also be limited by accumulation problems (e.g. reusing dust from FeCr production might lead to Zn accumulation in the furnace).

11.8 BAT conclusions for nickel and/or cobalt production

11.8.1 Energy

BAT 163. In order to use energy efficiently, BAT is to use one or a combination of the techniques given below.

	Technique
a	Use of oxygen-enriched air in smelting furnaces and oxygen converters
b	Use of heat recovery boilers
c	Use of the flue-gas generated in the furnace within the process (e.g. drying)
d	Use of heat exchangers

11.8.2 Air emissions

11.8.2.1 Diffuse emissions

BAT 164. In order to reduce diffuse dust emissions to air from the charging of a furnace, BAT is to use enclosed conveyor systems.

BAT 165. In order to reduce diffuse dust emissions to air from smelting, BAT is to use covered and hooded launders connected to an abatement system.

BAT 166. In order to reduce diffuse dust emissions from converting processes, BAT is to use operation under negative pressure and capture hoods connected to an abatement system.

BAT 167. In order to reduce diffuse emissions from atmospheric and pressure leaching, BAT is to use both of the techniques given below.

	Technique
a	Sealed or closed reactors, settlers and pressure autoclaves/vessels
b	Use of oxygen or chlorine instead of air in leaching stages

BAT 168. In order to reduce diffuse emissions from solvent extraction refining, BAT is to use one of the techniques given below.

	Technique
a	Use of a low or a high shear mixer for the solvent/aqueous mixture
b	Use of covers for the mixer and separator
c	Use of completely sealed tanks connected to an abatement system

BAT 169. In order to reduce diffuse emissions from electrowinning, BAT is to use a combination of the techniques given below.

	Technique	Applicability
a	Collection and reuse of chlorine gas	Only applicable to chloride-based electrowinning
b	Use of polystyrene beads to cover cells	Generally applicable
c	Use of foaming agents to cover the cells with a stable layer of foam	Only applicable to sulphate-based electrowinning

BAT 170. In order to reduce diffuse emissions from the hydrogen reduction process when producing nickel powder and nickel briquettes (pressure processes), BAT is to use a sealed or closed reactor, a settler and a pressure autoclave/vessel, a powder conveyor and a product silo.

11.8.2.2 Channelled dust emissions

BAT 171. When processing sulphidic ores, in order to reduce dust and metal emissions to air from the handling and storage of raw materials, material pretreatment processes (such as ore preparation and ore/concentrate drying), furnace charging, smelting, converting, thermal refining and nickel powder and briquette production, BAT is to use a bag filter or a combination of an ESP and a bag filter.

BAT-associated emission levels: See Table 11.48.

Table 11.48: BAT-associated emission levels for dust emissions to air from the handling and storage of raw materials, material pretreatment processes (such as ore preparation and ore/concentrate drying), furnace charging, smelting, converting, thermal refining and nickel powder and briquette production when processing sulphidic ores

Parameter	BAT-AEL (mg/Nm ³) ⁽¹⁾
Dust	2–5

⁽¹⁾ As a daily average or as an average over the sampling period.

The associated monitoring is in BAT 10.

11.8.2.3 Nickel and chlorine emissions

BAT 172. In order to reduce nickel and chlorine emissions to air from the atmospheric or pressure leaching processes, BAT is to use a wet scrubber.

BAT-associated emission levels: See Table 11.49.

Table 11.49: BAT-associated emission levels for nickel and chlorine emissions to air from the atmospheric or pressure leaching processes

Parameter	BAT-AEL (mg/Nm ³) ⁽¹⁾
Ni	≤ 1
Cl ₂	≤ 1

⁽¹⁾ As an average over the sampling period.

The associated monitoring is in BAT 10.

BAT 173. In order to reduce nickel emissions to air from the nickel matte refining process using ferric chloride with chlorine, BAT is to use a bag filter.

BAT-associated emission levels: See Table 11.50.

Table 11.50: BAT-associated emission levels for nickel emissions to air from the nickel matte refining process using ferric chloride with chlorine

Parameter	BAT-AEL (mg/Nm ³) ⁽¹⁾
Nickel	≤ 1
⁽¹⁾ As an average over the sampling period.	

The associated monitoring is in BAT 10.

11.8.2.4 Sulphur dioxide emissions

BAT 174. When processing sulphidic ores, in order to reduce SO₂ emissions to air (other than those that are routed to the sulphuric acid plant) from smelting and converting, BAT is to use one of the techniques given below.

	Technique ⁽¹⁾
a	Lime injection followed by a bag filter
b	Wet scrubber
⁽¹⁾ Descriptions of the techniques are given in Section 11.10.	

11.8.2.5 NH₃ emissions

BAT 175. In order to reduce NH₃ emissions to air from nickel powder and briquette production, BAT is to use a wet scrubber.

11.8.3 Waste

BAT 176. In order to reduce the quantities of waste sent for disposal, BAT is to organise operations on site so as to facilitate process residues reuse or, failing that, process residues recycling, including by using one or a combination of the techniques given below.

	Technique	Applicability
a	Use of the granulated slag generated in the electric arc furnace (used in smelting) as an abrasive or construction material	Applicability depends on the metal content of the slag
b	Use of the off-gas dust recovered from the electric arc furnace (used in smelting) as a raw material for zinc production	Generally applicable
c	Use of the matte granulation off-gas dust recovered from the electric arc furnace (used in smelting) as a raw material for the nickel refinery/re-smelting	Generally applicable
d	Use of the sulphur residue obtained after matte filtration in the chlorine-based leaching as a raw material for sulphuric acid production	Generally applicable
e	Use of the iron residue obtained after sulphate-based leaching as a feed to the nickel smelter	Applicability depends on the metal content of the waste
f	Use of the zinc carbonate residue obtained from the solvent extraction refining as a raw material for zinc production	Applicability depends on the metal content of the waste
g	Use of the copper residues obtained after leaching from the sulphate- and chlorine-based leaching as a raw material for copper production	Generally applicable

11.9 BAT conclusions for carbon and/or graphite production

11.9.1 Air emissions

11.9.1.1 Diffuse emissions

BAT 177. In order to reduce diffuse PAH emissions to air from the storage, handling and transport of liquid pitch, BAT is to use one or a combination of the techniques given below.

	Technique
a	Back-venting of the liquid pitch storage tank
b	Condensation by external and/or internal cooling with air and/or water systems (e.g. conditioning towers), followed by filtration techniques (adsorption scrubbers or ESP)
c	Collection and transfer of collected off-gases to abatement techniques (dry scrubber or thermal oxidiser/regenerative thermal oxidiser) available at other stages of the process (e.g. mixing and shaping or baking)

11.9.1.2 Dust and PAH emissions

BAT 178. In order to reduce dust emissions to air from the storage, handling and transportation of coke and pitch, and mechanical processes (such as grinding) and graphitising and machining, BAT is to use a bag filter.

BAT-associated emission levels: See Table 11.51.

Table 11.51: BAT-associated emission levels for dust and BaP (as an indicator of PAH) emissions to air from the storage, handling and transportation of coke and pitch, and mechanical processes (such as grinding) and graphitising and machining

Parameter	BAT-AEL (mg/Nm ³) ⁽¹⁾
Dust	2–5
BaP	≤ 0.01 ⁽²⁾
⁽¹⁾ As an average over the sampling period.	
⁽²⁾ BaP particles are only expected if processing solid pitch.	

The associated monitoring is in BAT 10.

BAT 179. In order to reduce dust and PAH emissions to air from the production of green paste and green shapes, BAT is to use one or a combination of the techniques given below.

	Technique ⁽¹⁾
a	Dry scrubber using coke as the adsorbent agent and with or without precooling, followed by a bag filter
b	Coke filter
c	Regenerative thermal oxidiser
d	Thermal oxidiser
⁽¹⁾ Descriptions of the techniques are given in Section 11.10.	

BAT-associated emission levels: See Table 11.52.

Table 11.52: BAT-associated emission levels for dust and BaP (as an indicator of PAH) emissions to air from the production of green paste and green shapes

Parameter	BAT-AEL (mg/Nm ³) ⁽¹⁾
Dust	2–10 ⁽²⁾
BaP	0.001–0.01

⁽¹⁾ As an average over the sampling period.
⁽²⁾ The lower end of the range is associated with the use of a dry scrubber using coke as the adsorbent agent followed by a bag filter. The upper end of the range is associated with the use of a thermal oxidiser.

The associated monitoring is in BAT 10.

BAT 180. In order to reduce dust and PAH emissions to air from baking, BAT is to use one or a combination of the techniques given below.

	Technique ⁽¹⁾	Applicability
a	ESP, in combination with a thermal oxidation step (e.g. regenerative thermal oxidiser) when highly volatile compounds are expected	Generally applicable
b	Regenerative thermal oxidiser, in combination with a pretreatment (e.g. ESP) in cases of a high dust content in the exhaust gas	Generally applicable
c	Thermal oxidiser	Not applicable to continuous ring furnaces

⁽¹⁾ Descriptions of the techniques are given in Section 11.10.

BAT-associated emission levels: See Table 11.53.

Table 11.53: BAT-associated emission levels for dust and BaP (as an indicator of PAH) emissions to air from baking and rebaking

Parameter	BAT-AEL (mg/Nm ³) ⁽¹⁾
Dust	2–10 ⁽²⁾
BaP	0.005–0.015 ⁽³⁾ ⁽⁴⁾

⁽¹⁾ As an average over the sampling period.
⁽²⁾ The lower end of the range is associated with the use of a combination of an ESP and a regenerative thermal oxidiser. The higher end of the range is associated with the use of a thermal oxidiser.
⁽³⁾ The lower end of the range is associated with the use of a thermal oxidiser. The upper end of the range is associated with the use of a combination of an ESP and a regenerative thermal oxidiser.
⁽⁴⁾ For cathode production, the upper end of the range is 0.05 mg/Nm³.

The associated monitoring is in BAT 10.

BAT 181. In order to reduce dust and PAH emissions to air from impregnation, BAT is to use one or a combination of the techniques given below.

	Technique ⁽¹⁾
a	Dry scrubber followed by a bag filter
b	Coke filter
c	Thermal oxidiser

⁽¹⁾ Descriptions of the techniques are given in Section 11.10.

BAT-associated emission levels: See Table 11.54.

Table 11.54: BAT-associated emission levels for dust and BaP (as an indicator of PAH) emissions to air from impregnation

Parameter	BAT-AEL (mg/Nm ³) ⁽¹⁾
Dust	2–10
BaP	0.001–0.01
⁽¹⁾ As an average over the sampling period.	

The associated monitoring is in BAT 10.

11.9.1.3 Sulphur dioxide emissions

BAT 182. In order to reduce SO₂ emissions to air when there is a sulphur addition in the process, BAT is to use a dry and/or wet scrubber

11.9.1.4 Organic compound emissions

BAT 183. In order to reduce emissions of organic compounds to air, including phenol and the formaldehyde from the impregnation stage where special impregnation agents such as resins and biodegradable solvents are used, BAT is to use one of the techniques given below.

	Technique ⁽¹⁾
a	Regenerative thermal oxidiser in combination with an ESP for mixing, baking and impregnation stages
b	Biofilter and/or bioscrubber for the impregnation stage where special impregnation agents such as resins and biodegradable solvents are used
⁽¹⁾ Descriptions of the techniques are given in Section 11.10.	

BAT-associated emission levels: See Table 11.55.

Table 11.55: BAT-associated emission levels for TVOC emissions to air from mixing, baking and impregnation

Parameter	BAT-AEL (mg/Nm ³) ⁽¹⁾ ⁽²⁾
TVOC	≤ 10–40
⁽¹⁾ As an average over the sampling period.	
⁽²⁾ The lower end of the range is associated with the use of an ESP in combination with a regenerative thermal oxidiser. The upper end of the range is associated with the use of a biofilter and/or a bioscrubber.	

The associated monitoring is in BAT 10.

11.9.2 Waste

BAT 184. In order to reduce the quantities of waste sent for disposal, BAT is to organise operations on site so as to facilitate process residues reuse or, failing that, process residues recycling, including by reuse or recycling of carbon and other residues from the production processes within the process or in other external processes.

11.10 Description of techniques

11.10.1 Air emissions

The techniques described below are listed according to the main pollutant(s) they are aimed to abate.

11.10.1.1 Dust emissions

Technique	Description
Bag filter	Bag filters, often referred to as fabric filters, are constructed from porous woven or felted fabric through which gases flow to remove particles. The use of a bag filter requires a fabric material selection suited to the characteristics of the off-gases and the maximum operating temperature.
Electrostatic precipitator (ESP)	Electrostatic precipitators operate such that particles are charged and separated under the influence of an electrical field. They are capable of operating over a wide range of conditions. In a dry ESP, the collected material is mechanically removed (e.g. by shaking, vibration, compressed air), while in a wet ESP it is flushed with a suitable liquid, usually water.
Wet scrubber	Wet scrubbing entails separating the dust by intensively mixing the incoming gas with water, usually combined with the removal of the coarse particles through the use of centrifugal force. The removed dust is collected at the bottom of the scrubber. Also, substances such as SO ₂ , NH ₃ , some VOC and heavy metals may be removed

11.10.1.2 NO_x emissions

Technique	Description
Low-NO _x burner	Low-NO _x burners reduce the formation of NO _x by reducing peak flame temperatures, delaying but completing the combustion and increasing the heat transfer (increased emissivity of the flame). The ultra-low-NO _x burners includes combustion staging (air/fuel) and flue-gas recirculation
Oxy-fuel burner	The technique involves the replacement of the combustion air with oxygen, with the consequent elimination/reduction of thermal NO _x formation from nitrogen entering the furnace. The residual nitrogen content in the furnace depends on the purity of the oxygen supplied, on the quality of the fuel and on the potential air inlet
Flue-gas recirculation	This implies the reinjection of flue-gas from the furnace into the flame to reduce the oxygen content and therefore the temperature of the flame. The use of special burners is based on internal recirculation of combustion gases which cool the root of the flames and reduce the oxygen content in the hottest part of the flames

11.10.1.3 SO₂, HCl, and HF emissions

Technique	Description
Dry or semi-dry scrubber	Dry powder or a suspension/solution of an alkaline reagent (e.g. lime or sodium bicarbonate) is introduced and dispersed in the off-gas stream. The material reacts with the acidic gaseous species (e.g. SO ₂) to form a solid which is removed by filtration (bag filter or electrostatic precipitator). The use of a reaction tower improves the removal efficiency of the scrubbing system. Adsorption can also be achieved by the use of packed towers (e.g. coke filter). For existing plants, the performance is linked to process parameters such as temperature (min. 60 °C), moisture content, contact time, gas fluctuations and to the capability of the dust filtration system (e.g. bag filter) to cope with the additional dust load
Wet scrubber	In the wet scrubbing process, gaseous compounds are dissolved in a scrubbing solution (e.g. an alkaline solution containing lime, NaOH, or H ₂ O ₂). Downstream of the wet scrubber, the off-gases are saturated with water and a separation of the droplets is carried out before discharging the off-gases. The resulting liquid is further treated by a waste water process and the insoluble matter is collected by sedimentation or filtration. For existing plants, this technique may require significant space availability
Use of low-sulphur fuels	The use of natural gas or low-sulphur fuel oil reduces the amount of SO ₂ and SO ₃ emissions from the oxidation of sulphur contained in the fuel during combustion
Polyether-based absorption/desorption system	A polyether-based solvent is used to selectively absorb the SO ₂ from the exhaust gases. Then the absorbed SO ₂ is stripped in another column and the solvent is fully regenerated. The stripped SO ₂ is used to produce liquid SO ₂ or sulphuric acid

11.10.1.4 Mercury emissions

Technique	Description
Activated carbon adsorption	This process is based on the adsorption of mercury onto the activated carbon. When the surface has adsorbed as much as it can, the adsorbed content is desorbed as part of the regeneration of the adsorbent
Selenium adsorption	This process is based on the use of selenium-coated spheres in a packed bed. The red amorphous selenium reacts with the mercury in the gas to form HgSe. The filter is then treated to regenerate the selenium.

11.10.1.5 VOC, PAH and PCDD/F emissions

Technique	Description
Afterburner or thermal oxidiser	Combustion system in which the pollutant within the exhaust gas stream reacts with oxygen in a temperature-controlled environment to create an oxidation reaction
Regenerative thermal oxidiser	Combustion system that employs a regenerative process to utilise the thermal energy in the gas and carbon compounds by using refractory support beds. A manifold system is needed to change the direction of the gas flow to clean the bed. It is also known as a regenerative afterburner
Catalytic thermal oxidiser	Combustion system where the decomposition is carried out on a metal catalyst surface at lower temperatures, typically from 350 °C to 400 °C. It is also known as a catalytic afterburner
Biofilter	It consists of a bed of organic or inert material, where pollutants from off-gas streams are biologically oxidised by microorganisms
Bioscrubber	It combines wet gas scrubbing (absorption) and biodegradation, the scrubbing water containing a population of microorganisms suitable to oxidise the noxious gas components
Select and feed the raw materials according to the furnace and the abatement techniques used	The raw materials are selected in such a way that the furnace and the abatement system used to achieve the required abatement performance can treat the contaminants contained in the feed properly
Optimise combustion conditions to reduce the emissions of organic compounds	Good mixing of air or oxygen and carbon content, control of the temperature of the gases and residence time at high temperatures to oxidise the organic carbon comprising PCDD/F. It can also include the use of enriched air or pure oxygen
Use charging systems, for a semi-closed furnace, to give small additions of raw material	Add raw material in small portions in semi-closed furnaces to reduce the furnace cooling effect during charging. This maintains a higher gas temperature and prevents the reformation of PCDD/F
Internal burner system	The exhaust gas is directed through the burner flame and the organic carbon is converted with oxygen to CO ₂
Avoid exhaust systems with a high dust build-up for temperatures > 250 °C	The presence of dust at temperatures above 250 °C promotes the formation of PCDD/F by de novo synthesis
Injection of adsorption agent in combination with efficient dust collection system	PCDD/F may be adsorbed onto dust and hence emissions can be reduced using an efficient dust filtration system. The use of a specific adsorption agent promotes this process and reduces the emissions of PCDD/F
Rapid quenching	PCDD/F de novo synthesis is prevented by rapid gas cooling from 400 °C to 200 °C

11.10.2 Water emissions

Techniques	Descriptions
Chemical precipitation	The conversion of dissolved pollutants into an insoluble compound by adding chemical precipitants. The solid precipitates formed are subsequently separated by sedimentation, flotation or filtration. If necessary, this may be followed by ultrafiltration or reverse osmosis. Typical chemicals used for metal precipitation are lime, sodium hydroxide, and sodium sulphide.
Sedimentation	The separation of suspended particles and suspended material by gravitational settling
Flotation	The separation of solid or liquid particles from waste water by attaching them to fine gas bubbles, usually air. The buoyant particles accumulate at the water surface and are collected with skimmers
Filtration	The separation of solids from waste water by passing them through a porous medium. Sand is the most commonly used filtering medium
Ultrafiltration	A filtration process in which membranes with pore sizes of approximately 10 μm are used as the filtering medium
Activated carbon filtration	A filtration process in which activated carbon is used as the filtering medium
Reverse osmosis	A membrane process in which a pressure difference applied between the compartments separated by the membrane causes water to flow from the more concentrated solution to the less concentrated one

11.10.3 Other descriptions

Techniques	Descriptions
Demister	Demisters are filter devices that remove entrained liquid droplets from a gas stream. They consist of a woven structure of metal or plastic wires, with a high specific surface area. Through their momentum, small droplets present in the gas stream impinge against the wires and coalesce into bigger drops
Centrifugal system	Centrifugal systems use inertia to remove droplets from off-gas streams by imparting centrifugal forces
Boosted suction system	Systems designed to modify the extraction fan capacity based on the sources of the fumes which change over the charging, melting and tapping cycles. Automated control of the burner rate during charging is also applied to ensure a minimum gas flow during operations with the door opened
Centrifugation of swarf	Centrifugation is a mechanical method to separate the oil from the swarf. To increase the velocity of the sedimentation process, a centrifugation force is applied to the swarf and the oil is separated
Drying of swarf	The swarf drying process uses an indirectly heated rotary drum. To remove the oil, a pyrolytic process takes place at a temperature between 300 °C and 400 °C
Sealed furnace door or furnace door sealing	The furnace door is designed to provide efficient sealing to prevent diffuse emissions escaping and to maintain the positive pressure inside the furnace during the smelting/melting stage

12 CONCLUDING REMARKS AND RECOMMENDATIONS FOR FUTURE WORK

The key milestones of the review process are summarised in Table 12.1.

Table 12.1: Key milestones of the review process of the BREF for the Non-Ferrous Metals Industries

Key milestone	Date
Reactivation of the TWG	12 December 2006
Call for wishes	23 February 2007
Kick-off meeting	24–26 September 2007
Collection of information	31 March 2008
First draft (D1) of revised NFM BREF	14 November 2008
End of commenting period on first draft (approximately 1800 comments)	26 January 2009
Second draft of revised NFM BREF (D2)	29 July 2009
End of commenting period (approximately 1240 comments)	15 October 2009
New way forward (restructuring of the BREF with subgroups and new data collection)	26 May 2011
Third draft of revised NFM BREF (D3)	28 February 2013
End of commenting period (approximately 2700 comments)	26 April 2013
Final TWG meeting	17–21 March 2014

During the review process, around 40 site visits in nine EU Member States were carried out, comprising primary and secondary copper production, primary and secondary aluminium production and salt slag recycling, primary and secondary lead production, primary and secondary zinc production (Waelz kiln), cobalt production, ferro-alloys production, nickel production and carbon and graphite production.

Sources of information and information gaps

During the review process, several hundred documents were shared by the TWG via the Commission's BAT information system (BATIS). These included approximately 100 questionnaires containing plant-specific data on emissions to air and water. Additional data on these emissions were also submitted in aggregate form without using the agreed questionnaire template. Major contributors of information were EAA, ECI, ILA, IZA, EPMF, Euroalliages, The Nickel Institute, ECGA, several EU Member States (Austria, Finland, France, Germany, Italy, the Netherlands, Portugal, Spain and the United Kingdom) and Norway.

The review of the NFM BREF was started under the IPPC Directive (96/61/EC replaced by 2008/1/EC). In 2011, after the publication of the Industrial Emissions Directive (IED) (2010/75/EU), it was agreed that the information available was generally not sufficient to derive sound BAT conclusions with the level of detail required under the new IED regime, in particular regarding the description and applicability of techniques. Also, given the increased importance of the BAT-associated emission levels under the IED regime, it was considered that the data situation on which they are based needed to be improved.

Also, TWG subgroups were created in order to improve the data situation and to restructure the 'Techniques to consider in the determination of BAT' sections. This was not the case for the production of mercury, refractory metals and alkali and alkaline earth metals, due to the fact that

there are very few plants in operation in the EU-28. The information available for the refractory metals and alkali and alkaline earth metals production is now contained in a self-standing document, which is available on the EIPPCB website. The documents provided by the TWG subgroups and all the other documents submitted during the NFM BREF review process were assessed by the EIPPCB. As a result, approximately 315 documents, including also the references used for the drafting of the original NFM BREF (2001) that are still useful, are referenced in the revised BREF (see the REFERENCES chapter).

The production of sulphuric acid from non-ferrous metals installations is within the scope of the LVIC-AAF BREF. At the NFM kick-off TWG meeting it was decided:

- that techniques applied by NFM industries will cross-reference the LVIC-AAF BREF and build on information already there;
- to gather data from well-performing sulphuric acid production plants in NFM installations that may provide additional information for the review of LVIC-AAF BREF.

The information on the techniques applied by NFM industries to produce sulphuric acid was provided by the TWG members. In order to provide additional information for the review of the LVIC-AAF BREF, the techniques that are not currently described in the LVIC-AAF BREF are described mainly in Chapters 2, 3, 5 and 6 of this document. For the sake of consistency and to avoid overlaps, the NFM TWG decided, during the NFM final TWG meeting, to remove the production of sulphuric acid from the scope of the NFM BREF. The Czech Republic, Denmark, Spain, Finland, Poland, Sweden, Eurometaux and Orgalime would have preferred to keep the production of sulphuric acid within the scope of the NFM BREF because they believe that this would have better taken into account the peculiarity of the sulphuric acid produced by NFM installations.

Correction to the LVIC-AAF BREF adopted in 2007

During the final TWG meeting, it was acknowledged that in Table 4.24 '*Conversion rates and SO₂ emission levels associated with BAT*' in the LVIC-AAF BREF (adopted in 2007), in the 'Other double contact/double absorption plants' row, the upper end of the BAT-AEL range for SO₂ emissions from the production of sulphuric acid from non-ferrous metals production in a double contact/double absorption plant needs to be corrected. This value should be 770 mg/Nm³ (as a daily average) instead of 680 mg/Nm³ (as a daily average).

Degree of consensus reached during the information exchange

A total of 206 BAT conclusions have been set. At the final TWG meeting in March 2014, a high degree of consensus was reached on most of these BAT conclusions. However, 18 dissenting views were expressed (see Table 12.2).

Table 12.2: Split views

BAT conclusion	View expressed by	Split view
BAT 11 Table 11.1	Cefic, Eurometaux	A dissenting view was expressed by Eurometaux, supported by Cefic, proposing to change footnote (2) in Table 11.1, as follows: 'The lower end of the range can be achieved by a combination of techniques except for processes using raw materials with varying Hg content (e.g. Waelz kilns).'
BAT 17 Table 11.2	Austria, Germany, EEB	A dissenting view was expressed by Austria, Germany EEB, proposing to delete footnote (2) from Table 11.2
	Cefic, Eurometaux, Euromines	A dissenting view was expressed by Eurometaux, Euromines and Cefic, who consider that the BAT-AEL for mercury emissions to water from copper production should be ≤ 0.05 mg/l
Horizontal	Austria, Finland, Germany, The Netherlands, Sweden, EEB	A dissenting view was expressed by Austria, Finland, Germany, the Netherlands, Sweden and EEB, who would have preferred to set a BAT-AEL for copper, lead, arsenic and cadmium emissions to air instead of mentioning them with indicative values in footnotes related to the BAT-AEL for dust
BAT 48 Table 11.5	Poland, Spain, Cefic, Euroalliages, Eurometaux, Euromines	Eurometaux, supported by Poland, Spain, Euromines, Euroalliages and Cefic, expressed a dissenting view that the BAT-AEL for emissions of PCDD/F to air for existing shaft furnaces producing secondary copper should be expressed as a range, 0.1–0.4 ng I-TEQ/Nm ³
BAT 50 Table 11.6	Eurometaux, Euromines	Eurometaux, supported by Euromines, expressed a dissenting view that the upper level of the BAT-AEL range for SO ₂ emissions to air from secondary copper production should be set at 450 mg/Nm ³
BAT 60	Germany, EEB	Germany, supported by EEB, expressed a dissenting view that a BAT-AEL for SO ₂ emissions to air from a baking plant in an anode production plant integrated in a primary aluminium smelter should be set and expressed as a range, 35–150 mg/Nm ³
BAT 67 Table 11.11	Spain, Eurometaux, Euromines	Eurometaux, supported by Spain and Euromines, expressed a dissenting view that the levels of the BAT-AEL range for dust emissions to air from Söderberg cells should be 5–10 mg/Nm ³
BAT 68 Table 11.13	Germany, EEB	Germany and EEB expressed a dissenting view that the upper end of the dust BAT-AEL range from melting and molten metal treatment and casting in primary aluminium production should be set at 5 mg/Nm ³
BAT 69, Table 11.14	United Kingdom	The United Kingdom expressed a dissenting view that the description of BAT 69(a) should be amended by adding the following sentence: 'However, it is considered that global trends in the cost and in the availability of low S anodes may lead to a situation where installations applying this technique will have to rely on higher sulphur content anodes up to 2 % as a yearly average.' Consequently, they also expressed a dissenting view that the upper end of the BAT-AEL range for SO ₂ emissions to air from the electrolytic cells should be 20 kg/t Al
	France, Spain, Eurometaux, Euromines	Eurometaux, supported by France, Spain and Euromines, expressed a dissenting view that, in the description of BAT 69(a), the sulphur content in the anode should be 2.5 % and, in the same description, the following sentence should be added: 'A management plan ensures control of the raw materials' S content and allows anticipation of the SO ₂ emissions, to take into account local environmental conditions.' Consequently, they also expressed a dissenting view that the upper end of the BAT-AEL range for SO ₂ emissions to air from the electrolytic cells should be 25 kg/t Al

BAT 82 Table 11.17	Austria, Germany, EEB	Austria, Germany and EEB expressed a dissenting view that footnote ⁽²⁾ on the dust emissions from the remelting of secondary aluminium production should be deleted
BAT 122 Table 11.34	Germany, Netherlands, EEB	Germany, the Netherlands and EEB expressed a dissenting view that the upper level of the dust BAT-AEL range from the melting of metallic and mixed metallic/oxidic streams, and from the slag fuming furnace and the Waelz kiln should be lower than 5 mg/Nm ³
BAT 156 Table 11.46	Germany, Netherlands, EEB	Germany, the Netherlands and EEB expressed a dissenting view that footnote ⁽²⁾ in Table 11.46 should be deleted
BAT 157	Spain, Eurometaux, Euroalliages	Spain and Euroalliages, supported by Eurometaux, expressed a dissenting view that wet scrubbers (as a stand-alone technique) should be considered BAT to reduce dust and metal emissions from closed furnaces in ferro-alloy production for existing plants where the applicability of ESPs or bag filters is limited by safety and configuration constraints
BAT 157 Table 11.46	Spain, Euroalliages	Spain and Euroalliages expressed a dissenting view that a footnote should be added in Table 11.46, stating that for existing plants the upper end of the BAT-AEL range can be up to 20 mg/Nm ³ where, due to safety and space constraints, a bag filter or an ESP cannot be used
BAT 178 Table 11.51	France, ECGA, Eurometaux	France and ECGA, supported by Eurometaux, expressed a dissenting view that a footnote should be added in Table 11.51, stating that the upper end of the range may be up to 10 mg/Nm ³ during temporary operations such as material handling and the loading and unloading of packing materials
BAT 180 Table 11.53	Austria, Germany, EEB	Austria, Germany and the European Environmental Bureau (EEB) expressed a dissenting view that footnote ⁽⁴⁾ in Table 11.53 should be deleted

Consultation of the Forum and subsequent formal adoption procedure of the BAT Conclusions

In accordance with Article 13(3) of the Directive, the Forum gave its opinion on the draft Best Available Techniques (BAT) reference document for the Non-Ferrous Metals Industries at its meeting of 4 December 2014:

1. The Forum welcomed the draft Best Available Techniques (BAT) reference document for the Non-Ferrous Metals Industries as presented by the Commission.
2. The Forum acknowledged the discussions held at its meeting of 4 December 2014 and agreed that the changes to the draft Best Available Techniques (BAT) reference document for the Non-Ferrous Metals Industries, as proposed in Annex A, should be included in the final document.
3. The Forum reaffirmed the comments in Annex B as representing the views of certain members of the forum but on which no consensus existed within the forum to include them in the final document.

Subsequently, the Commission took the opinion of the IED Article 13 Forum into account when preparing the draft Commission Implementing Decision establishing best available techniques (BAT) conclusions for the Non-Ferrous Metals Industries. The IED Article 75 Committee, at its meeting of 3 December 2015, gave a positive opinion on this draft Commission Implementing Decision.

Subsequently, the Commission Implementing Decision (EU) 2016/1032 establishing best available techniques (BAT) conclusions for the Non-Ferrous Metals Industries was adopted on 13 June 2016 and published in the Official Journal of the European Union (OJ L 174, 30.6.2016, p. 32)

Recommendations for future work

The information exchange revealed a number of issues on which further information should be collected during the next review of the NFM BREF. The recommendations for the next review include the following:

- Gather data on the emissions to air and water with the relevant reference conditions including, for the emissions to air, the oxygen content.
- Gather information on the production of other non-ferrous metals in the EU-28 not specifically addressed in this BREF (e.g. tungsten production). In particular, in the next NFM BREF, a new chapter dedicated to the production of refractory metals may be added, including a section on 'Techniques to consider in the determination of BAT'.
- It may be valuable to collect specific data and information including the oxygen content of the emission, the raw materials used, the production and the specific loads and flow rates (mass of pollutant released per mass of product manufactured or mass of raw material used and emission flow rate per mass of product manufactured or mass of raw material used) in order to evaluate the performance of the process-integrated techniques.
- Gather plant-specific information on the process-integrated and end-of-pipe techniques applied to prevent or reduce metal emissions to air from the various NFM sectors and on the emissions of metals achieved with those techniques with a view to revisiting the possibility to set BAT-AELs for metal emissions to air.
- Gather data on NO_x emissions to air in loads and in concentrations and other relevant contextual information, such as the applicability of the techniques in non-ferrous metal production, in order to consider setting, during the next review of the NFM BREF, sound BAT-AELs. The emissions data should be collected with the relevant reference conditions including the oxygen content in the flue-gas.
- Gather information on the arsenic content of the copper-bearing input materials of the copper production plants and the related emissions to water.
- Gather plant-specific information on the emissions arising from the cooling of matte and on the overall energy efficiency in plants using a flash converting furnace, also in comparison with the energy saved by the other type of converters when melting copper scrap.
- Gather data on dust emissions from anode casting in copper production with all the necessary contextual information (e.g. techniques used, monitoring applied, and characteristics of the dust, in particular the metal content).
- Gather data on cross-media effects associated with the use of a regenerative afterburner in copper production.
- Gather information about the chlorine content in the input to primary copper smelters.
- Gather data on channelled H₂SO₄ emissions to air from the electrowinning cell, the electrorefining cell, the washing chamber of the cathode stripping machine and the anode scrap washing machine in primary and secondary copper production.
- Gather plant-specific data on emissions to water from primary and secondary aluminium production.
- Gather plant-specific SO₂ data on emissions to air from baking furnaces in primary aluminium production.
- Gather plant-specific data on collection efficiencies, both in prebake and Söderberg plants in primary aluminium production.
- Gather information on the market availability of low-sulphur coke (less than 1.5 %) and specific data on the percentage of sulphur content in the anodes used by the primary aluminium industry.
- Gather plant-specific information on the costs of installing bag filters in casthouses integrated with primary aluminium smelters.

- Gather information on the cross-media effects associated with the reuse of heat and its influence on PCDD/F emissions, especially in lead and tin production.
- Gather information on the emissions to air of SbH_3 from the purification stage in zinc production.
- Gather additional information and data on the emissions of SO_2 from pyrometallurgical zinc production, including from outside Europe.
- Gather data on PCDD/F emissions from Waelz kilns in zinc production.
- Gather data on the performance of peroxide scrubbers in terms of SO_2 emissions to air in precious metals production.
- Gather information on emissions of Cl_2 to air from the hydrometallurgical operation in precious metals production and on the techniques used to reduce these emissions together with information related to the effects on the abatement of other pollutants (e.g. NO_x , SO_2).
- Gather information on the emissions to air from the predrying and calcination of lateritic ores in ferro-alloys production.
- Gather information on the economic viability of using a bag filter or a wet scrubber in combination with an ESP to reduce the dust emissions from closed furnaces in ferro-alloys production.
- Gather information and data on PAH (BaP) and TVOC emissions from the degreasing of titanium swarf and other relevant sources in ferro-alloy production.
- Gather information on Ni and Cl_2 emissions from atmospheric and pressure leaching in nickel production.
- Gather information and data on NH_3 emissions to air from nickel powder and briquette production.
- Gather data on emissions and relevant contextual information for carbon and graphite production.
- It may be useful to collect specific information on the level of accuracy and representativeness of the lower level of dust emissions measured in NFM installations.
- It may also be useful to collect specific information on the accuracy and representativeness of the PCDD/F emissions measured in NFM installations.

Suggested topics for future R&D work

The Commission is launching and supporting, through its Research and Technological Development programmes, a series of projects dealing with clean technologies, emerging effluent treatment and recycling technologies and management strategies. Potentially, these projects could provide a useful contribution to future BREF reviews. Readers are therefore invited to inform the European IPPC Bureau of any research results which are relevant to the scope of this document (see also the fifth section of the Preface of this document).

13 ANNEXES

13.1 Metal production processes

There are several processes or combinations of processes that are used to produce and melt metals. Pyrometallurgical and hydrometallurgical processes are both described in this section. The order in which they appear is not significant and does not indicate a ranking. The techniques described in the metal-specific chapters (3 to 10) give more details of the pyrometallurgical or hydrometallurgical processes, the metals that they are used for and the specific advantages and disadvantages in those applications.

Furnaces are used for a variety of purposes in this industry such as roasting or calcining raw materials, melting and refining metals and for smelting ores and concentrates.

The same type of furnace or process may be used for a variety of purposes and it is therefore intended to give an overview of the various applications [21, COM 1991], [25, OSPARCOM 1996], [34, UNECE 1995].

An important aspect in the choice of process is the relationship with the collection of fumes and gases; sealed, semi-closed and open processes are encountered. The design of the fume collection system is strongly influenced by geometry, which in some instances can make fume collection difficult. The use of transfer systems that require collection hoods to be removed from a furnace is an illustration of this design aspect.

Computerised fluid dynamics (CFD) studies and tracers have been used to model the flow of furnace gases and also the movement of fused electrolytes [233, COM 2008] so that diffuse emissions can be prevented or minimised. The use of these techniques has resulted in optimised gas collection systems (see Section 2.12.4.3).

The other important factor in the applicability of a particular process type is the type and variability of the raw material used; some processes allow a range of materials to be used but others need a defined type of material. Modifications to furnace' or electrolyte-charging systems to give small, even additions of raw materials have been developed in parallel and also contribute to the prevention of diffuse emissions [233, COM 2008]. These issues are considered further in the individual metal production chapters (3 to 10). The operation and maintenance of these systems are also critical. The types of furnaces likely to be encountered are summarised in Table 13.1.

Table 13.1: Typical furnace applications

Metal	Type of furnace likely to be encountered	Comment
Copper	Flash smelting furnace Bath smelting furnace Electric furnace Rotary furnace or converter Blast and shaft furnaces Induction furnace Reverberatory furnace (also hearth and chamber furnaces)	A variety of applications depending on the raw material and process stage
Aluminium	Molten electrolyte cells Reverberatory (and closed well) furnace Rotary, tilting rotary and shaft furnaces Induction furnace	Molten electrolyte cells only for primary production processes
Lead	Imperial Smelting Furnace (ISF) Doerschel (rotating/rocking) furnace Flash furnace (Kivcet) Bath furnace (QSL, Ausmelt/ISASMELT) Short rotary or tilting rotary furnace Reverberatory furnace Heated kettle Sinter machine Blast furnace Electric furnace TBRC (Kaldo)	A shaking ladle is used to produce tin from lead-tin alloys
Zinc	ISF and New Jersey distillation Fluidised bed roaster and sinter machine Induction and crucible furnaces Slag fuming furnaces and Waelz kiln	Temperature control of melting is vital
Precious metals	Electric furnace Blast furnace TBRC (Kaldo) Crucible furnace Rotary and static incinerator Cupel and BBOC Vacuum distillation	A variety of applications depending on the raw material and process stage
Refractory metals	Pusher furnace Band furnace Batch furnace Rotary furnace Electron beam furnace Vacuum induction furnace Herreshoff furnace	Pusher, band, batch and rotary furnaces are used for powder production. The electron beam furnace is used for ingot smelting. The Herreshoff furnace is only used for Mo concentrate roasting.
Ferro-alloys	Blast furnace Electric and submerged arc furnaces and electric furnace Reaction crucible Metallothermic reactor Induction furnace	The electric arc furnace is used as an open, semi-closed and closed furnace. The induction furnace is also used for remelting.
Alkali metals	Molten electrolyte cells Electric furnace, induction furnace	Induction furnaces are mostly used for remelting
Nickel and cobalt	Flash smelting furnace Bath smelting furnace Electric furnace, reverberatory furnace Converter Fluidised bed roaster Rotary kilns and furnace Induction furnace	A variety of applications depending on the raw material and process stage
Carbon and graphite	Pit furnace and vacuum furnace Electric furnace	

13.1.1 Furnaces for roasting and calcining

13.1.1.1 Rotary kilns

Rotary kilns use the same arrangement as a rotary furnace but operate without melting the charge as shown in Figure 13.1.

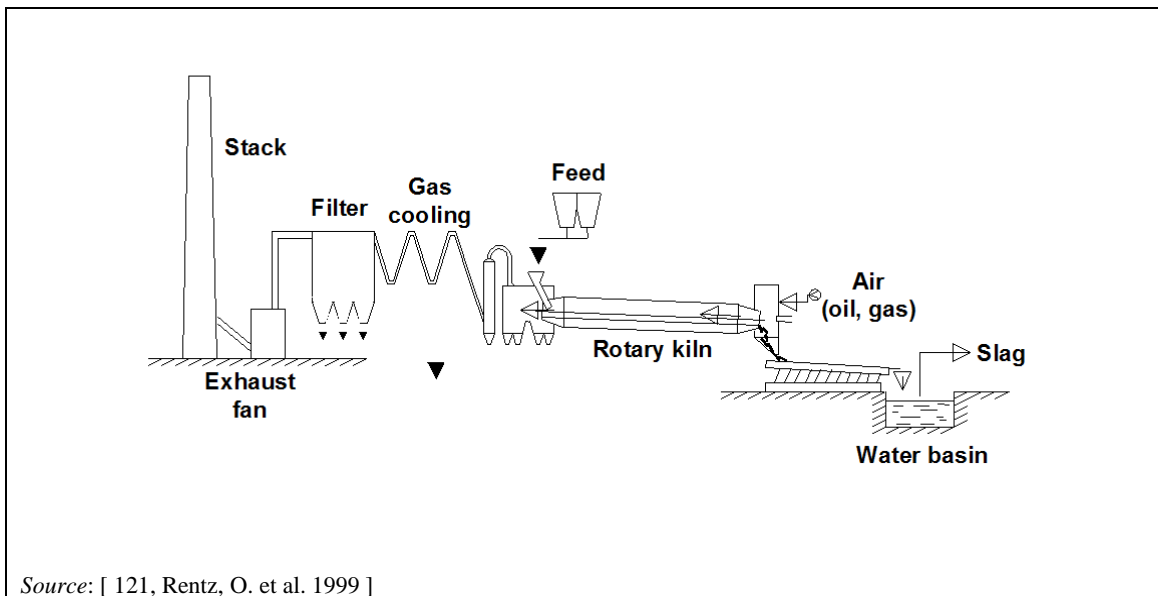

Figure 13.1: Rotary kiln

These kilns are used for a variety of fuming and calcining processes. Principal examples are the production of zinc oxide by fuming in a Waelz kiln; the production of calcine for the ferro-nickel process; the calcination of aluminium hydroxide and the calcination of magnesium hydroxide to a light burnt magnesium oxide for electrolytic magnesium production. Other applications are the pretreatment of a variety of raw materials at high temperatures, the incineration of photographic film and paper and the drying of concentrates and blends of material at lower temperatures.

13.1.1.2 Fluidised bed reactors

These furnaces are especially suitable when good temperature control is required, for example for the roasting of copper, nickel, cobalt and/or zinc sulphidic concentrates and the dead roasting of zinc concentrates and the partial roasting of copper concentrates as well as for Al_2O_3 calcining.

Combustion air is blown through tuyères in a grid at the bottom of the furnace and through the fluidised bed of material being roasted on the grid. (See Figure 13.2.)

The concentrate is fed onto the top of the bed. The oxygen reacts with the sulphides in the bed to produce sulphur dioxide (called the calcine). SO_2 gas is formed at about $900\text{ }^\circ\text{C}$ to $1000\text{ }^\circ\text{C}$.

Part of the calcine is removed mechanically from the furnace but some is carried over in the gas stream and is removed in a waste heat boiler, cyclones or an ESP. The roasting removes some minor impurities like chlorine, fluorine, selenium and mercury into the gas phase.

The heat generated in the roasting is recovered as steam by cooling coils in the bed and in the waste heat boiler. Utilisation of the steam may vary somewhat depending on the needs at the plant site, but part of it is always used for heating in the process.

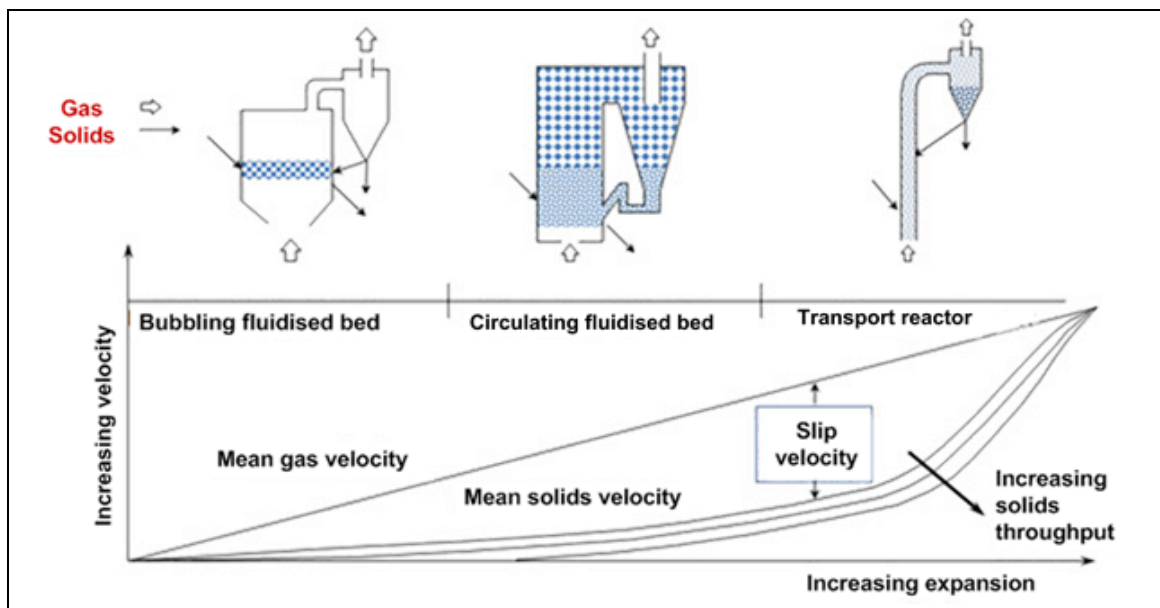

Figure 13.2: Fluidised bed reactors

13.1.1.3 Multiple hearth or Herreshoff furnace

The multiple hearth or Herreshoff furnace consists of a tower that contains 8 to 16 annular-shaped refractory brick hearths arranged vertically and enclosed in a cylindrical, refractory-lined steel shell. Material is usually fed to the outside of the top hearth of the furnace and is moved to the centre of this hearth by rabble arms where it falls to the centre of the second hearth. The material flow in the second hearth is from the centre outwards where it falls to the outside of the third hearth. This zigzag flow is repeated until the roasted material is discharged. The rabble arms are attached to a central, vertical rotating tube which is air-cooled. Gas or oil burners are provided at various points in the furnace depending on the combustion characteristics of the material. The cooling air that is used to cool the central tube is normally used as preheated combustion air for the furnace.

The furnace is shown in Figure 13.3.

This furnace is used to roast sulphidic ores or to produce metal directly or an oxide such as molybdenum oxide. Vaporised rhenium that is liberated in the roasting process of molybdenite can be recovered from the roaster off-gas by using a wet scrubbing system together with a subsequent rhenium recovery plant.

The multiple hearth furnace is also used to regenerate activated carbon. It is also reported to be used to treat steelmaking dust, leaching residues and coating sludges to recover zinc as an alternative to the Waelz process [227, IZA Report 2008]. It is reported to be used to produce steel and other metals from the residues in conjunction with a reduction furnace [257, Paul Wurth 2008].

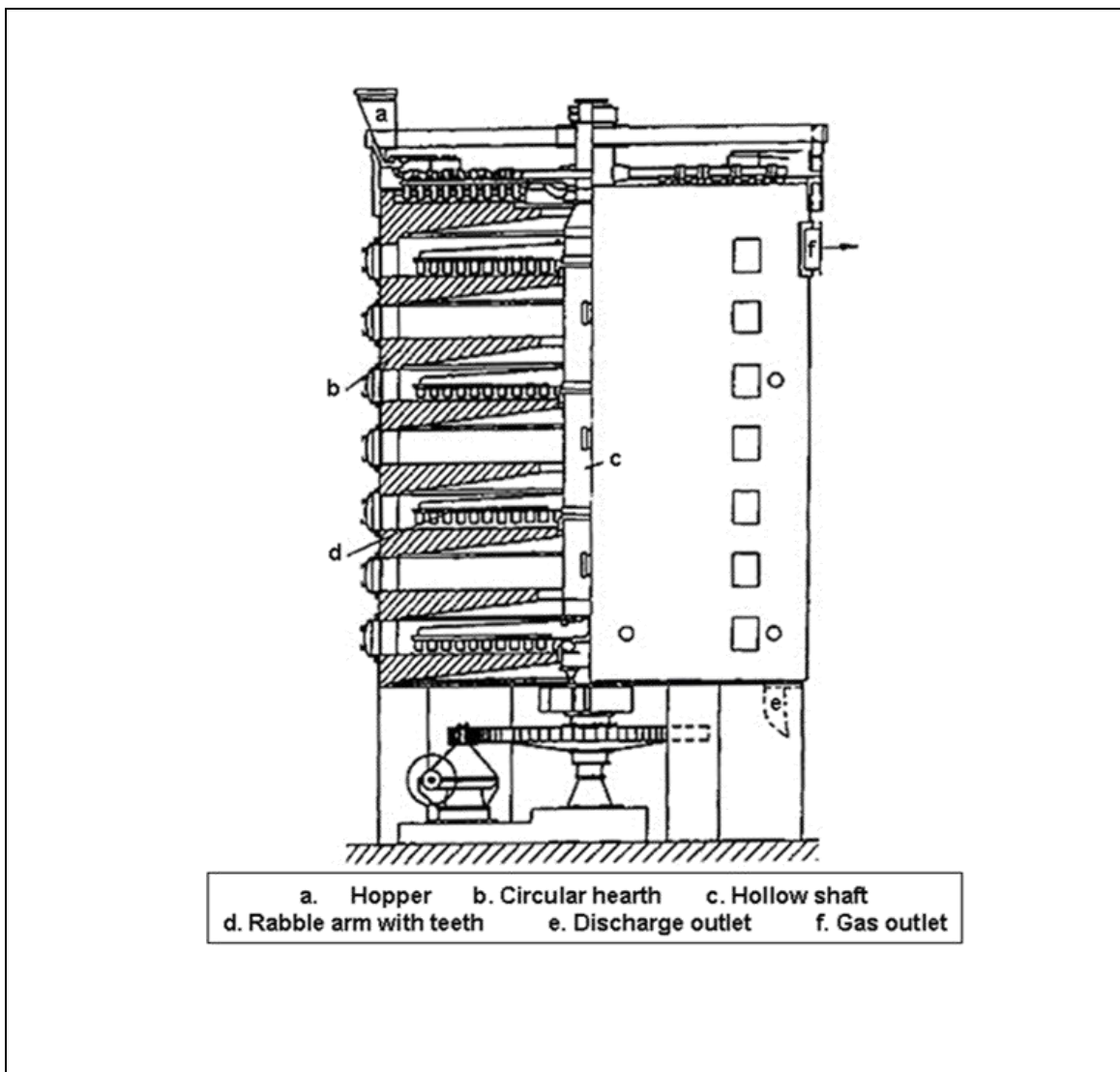

Figure 13.3: The Herreshoff or multiple hearth furnace

13.1.1.4 Sintering furnaces

The raw materials for the sintering plant are concentrates, ore fines, flue-dusts and other secondary material. In the sintering plant, the material is first agglomerated to the required extent and may be pelletised. The agglomerated material is fed to the sintering furnace in a layer or in carriers, heated gases are passed up (updraught) or down (downdraught) through the bed or travelling grate sinter machine.

In the steel belt sintering machine, a multi-compartment oven is used through which the green agglomerate is carried on a perforated steel conveyor belt. The agglomerate is dried in the drying compartment by circulating gas from the last cooling compartment. In the preheating compartment, the temperature of the agglomerate is increased so that the material is calcined and the carbon in the bed is ignited. Heating gas is taken from the second cooling compartment. In the sintering compartment, the sintering temperature is achieved. Heating gas, in addition to the energy from the burning of carbon and oxidation of iron, is taken from the first cooling compartment.

The front-end compartments are downdraught and cooling air is blown through the bed to the three cooling compartments. If additional energy is required to control the temperature profile in the compartments, CO gas from the smelting process or natural gas is burnt in the preheating and sintering compartments. Part of the product sinter or pellets is used as the bottom layer on

the steel belt to protect it from excessively high temperatures. The exhaust gases are cleaned in cascade scrubbers and/or fabric filters. Dusts are recycled back to the agglomeration. The furnace is shown in Figure 13.4.

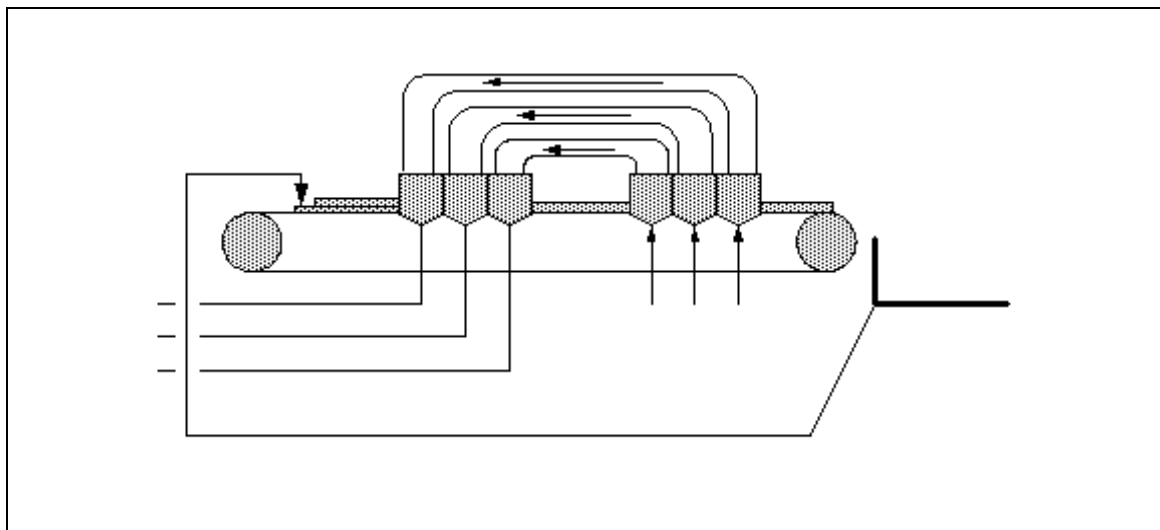

Figure 13.4: Steel belt sintering furnace

Sintering furnaces are applied to the sintering of a variety of ores, dusts and sludges. The steel belt sintering furnace is used for chromite pellets, manganese ore and niobium concentrate but may have other applications.

13.1.2 Smelting furnaces

Smelting involves the use or production of a lot of heat and much of this heat is recovered from the off-gases in waste heat boilers. Heat within a furnace, however, should be controlled to allow effective smelting and, at the same time, to protect the furnace. Cooling systems are used to protect the furnaces and to extend the life of the refractories. Waterfalls can be used to cool the outer shell or dedicated cooling elements can be used to cool the linings. Long campaigns are enjoyed when well-designed furnace cooling is employed.

Cooling is also beneficial at the throat of a furnace to prevent the build-up of slag and other materials that prevent effective sealing of off-gas collection hoods. Developments have provided reliable and safe cooling systems in these sensitive areas.

13.1.2.1 Reverberatory, hearth or closed well furnaces

The reverberatory furnace is also known as the hearth or closed well furnace. It is used for smelting concentrates and secondary material. Two general types exist, a simple bath furnace for the smelting of calcine or concentrates and a reverberatory hearth furnace for melting or refining. Furnaces can sometimes be tilted to pour or blow metal. Tuyères can be used for the injection of treatment gases or for the addition of fine material.

The furnace is constructed in a number of configurations depending on the particular metal and application. Variations include the provision of sloping hearths and side wells for specific melting purposes; and tuyères and lances for the addition of gases.

Slag is usually removed by tapping.

When sulphidic ores are smelted in a reverberatory furnace, the sulphur dioxide concentrations are normally low due to the high volume of combustion gases and the low rate of sulphur elimination in the furnace. The furnace is shown in Figure 13.5.

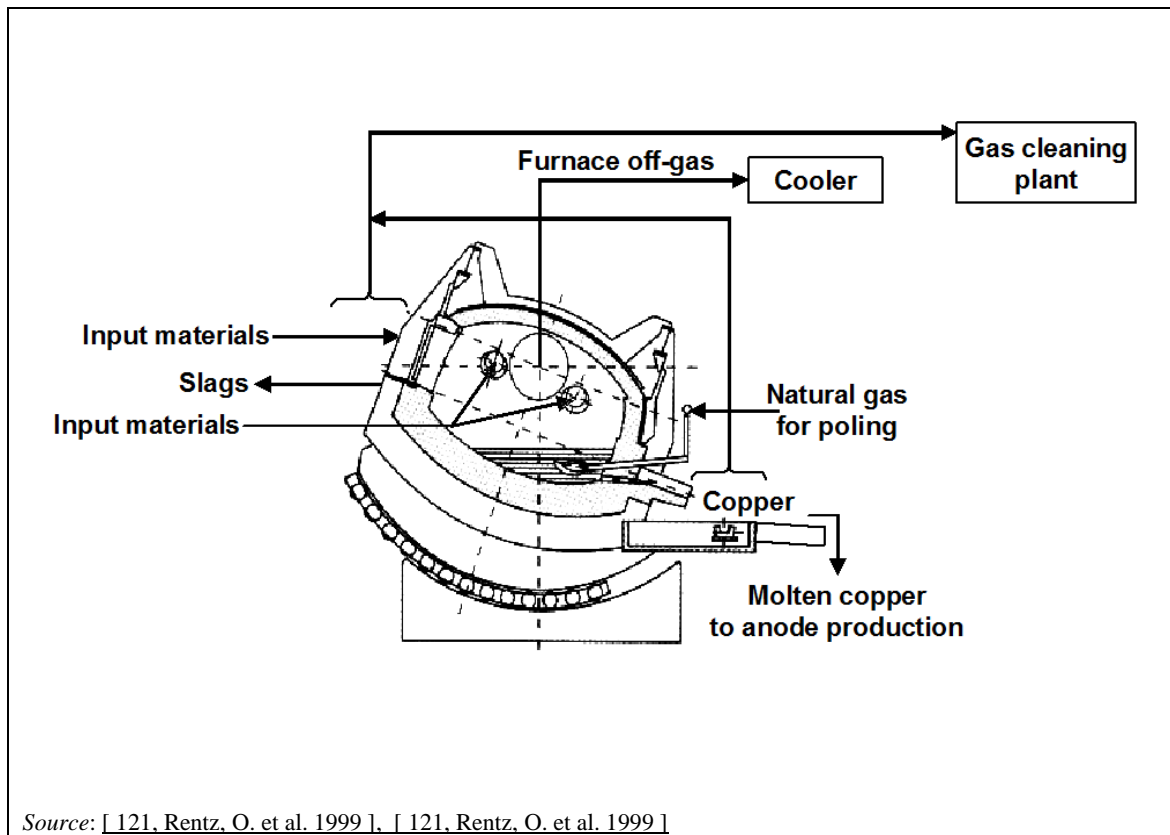

Figure 13.5: An example of a tilting reverberatory hearth furnace used for secondary materials

These furnaces are used for smelting a variety of primary and secondary raw materials and for fire refining. The use of a reverberatory (closed well) furnace for melting and recovering aluminium is described further below.

13.1.2.2 Blast furnaces (and the Imperial Smelting Furnace)

These are shaft furnaces and use a heated air blast from tuyères in the lower part of the furnace to burn coke that is mixed with the furnace charge of metal oxide or secondary material and fluxing agents. Materials are often briquetted before charging. The combustion of a portion of the coke raises the furnace temperature and the remainder produces CO, which, along with hydrogen produced by the water gas reaction, reduces the metal oxides to metal. The reaction produces a gas that is rich in carbon monoxide. This can be collected, cleaned and burnt to preheat the blast air or may be burnt off in a separate afterburner or in an oxygen-rich part of the furnace. In some instances, raw materials such as zinc oxide dusts are fed via the tuyères.

The metal collects on a hearth or crucible at the bottom of the furnace and may be tapped continuously or on a batch basis. When tapped batch-wise, the slag floats on top of the metal and the metal is tapped from a separate taphole. Fume extraction and abatement is used during the tapping process.

The furnace shell is normally water-cooled either over its entire height or in the lower part. The blast furnace can also be called a water jacket furnace. There are two variations of the blast

furnace depending on the feeding method and the operating temperature used to melt the metal. Furnaces can be:

- hot top, where the charge material is fed via a bell or a conveyor via a transfer lock;
- cold top, where the furnace is charged from a hopper and the feedstock provides the top seal itself.

The furnaces are shown in Figure 13.6 and Figure 13.7.

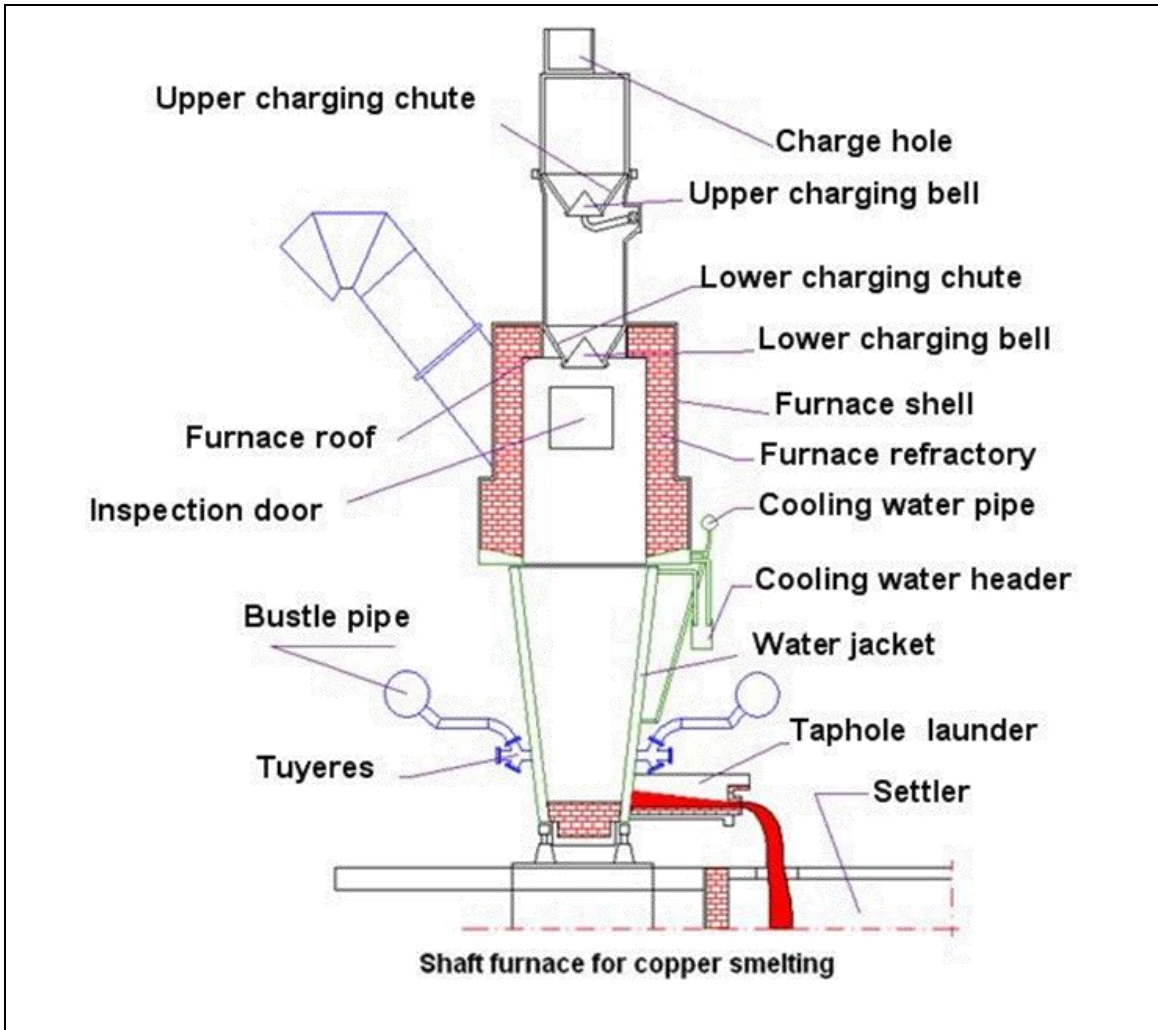

Figure 13.6: Blast furnace for primary copper smelting

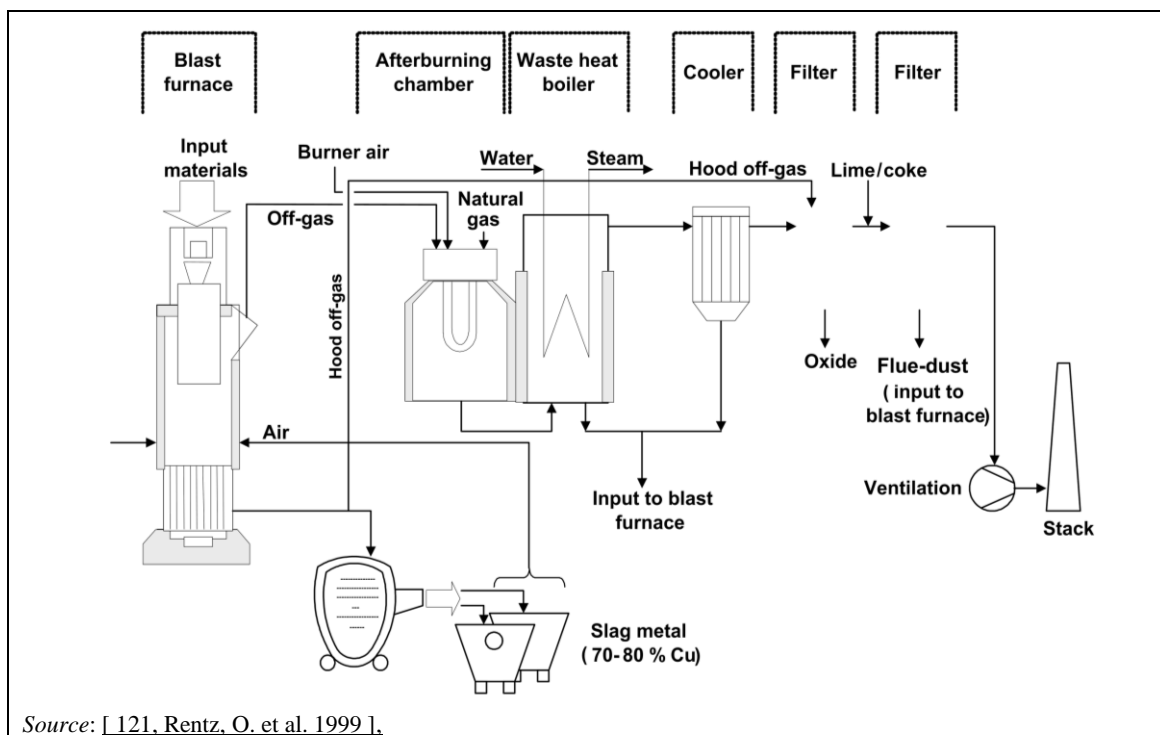

Figure 13.7: Blast furnace for secondary copper production

Blast furnaces are used to smelt and recover a variety of metals including precious metals, copper and lead from primary and secondary raw materials as well as high-carbon ferromanganese. Developments allow the charging of fine materials into the furnace via the tuyères and this can avoid briquetting and reduce the handling of dusty material.

One specific application of the blast furnace is the Imperial Smelting Furnace (ISF) which is used for mixed lead and zinc concentrates. This furnace uses a molten lead splash condenser after the blast furnace section to collect zinc vapour released in the gases while lead collects in the hearth. The zinc and cadmium collected in the condenser is purified in a fractional distillation system (New Jersey distillation column).

13.1.2.3 Electric reduction furnaces

The process in an electric reduction furnace is normally to reduce an element in an oxide state into metallic form. The process normally involves adding the oxide and a reducing agent, often carbon, to the furnace. Metallic components can also be added. To bring the reactants up to the reaction temperature, as well as to support the endothermic reactions, electrical energy is added. This electrical energy is converted to heat energy in a concentrated reaction zone near the electrode in the furnace. The furnaces are shown in Figure 13.8, Figure 13.9 and Figure 13.10.

Some furnaces will use a slag layer to develop the necessary energy. Others are based on resistance in the burden itself or in a coke bed. Some processes keep a plasma arc from the electrode tip to the coke bed or crater. Such electric reduction furnaces are sometimes called submerged arc furnaces. The reason is that the submerged arc is an important part of the conversion from electrical energy to heat energy in the reaction zone of the process. The electrical supply is normally based on a three-phase electrical power supply. The electrical power supply will be transformed from high voltage to low voltage. A DC (direct current) electrical supply can also be used and, in this case, the arc strikes between the electrodes and the carbon furnace lining or the electrodes and the raw materials in the lower part of the furnace. The electric reduction furnace can be divided into the following main components shown below:

- equipment for adding raw materials, such as ores, concentrates and reducing agents, or a mix of raw materials to the furnace;
- equipment to supply electrical energy to the furnace, consisting of an electrical grid, transformers, busbars and electrodes;
- the furnace body or shaft consisting of a shell, the lining and the furnace hood that protects the equipment from the heat;
- equipment for tapping the metal and slag from the furnace; often the metal should be sized afterwards in a crushing process;
- the off-gas system (off-gas ducts connected to a gas treatment system such as a cyclone, scrubber or filter), here with an energy recovery unit as well as the filter for the gas cleaning.

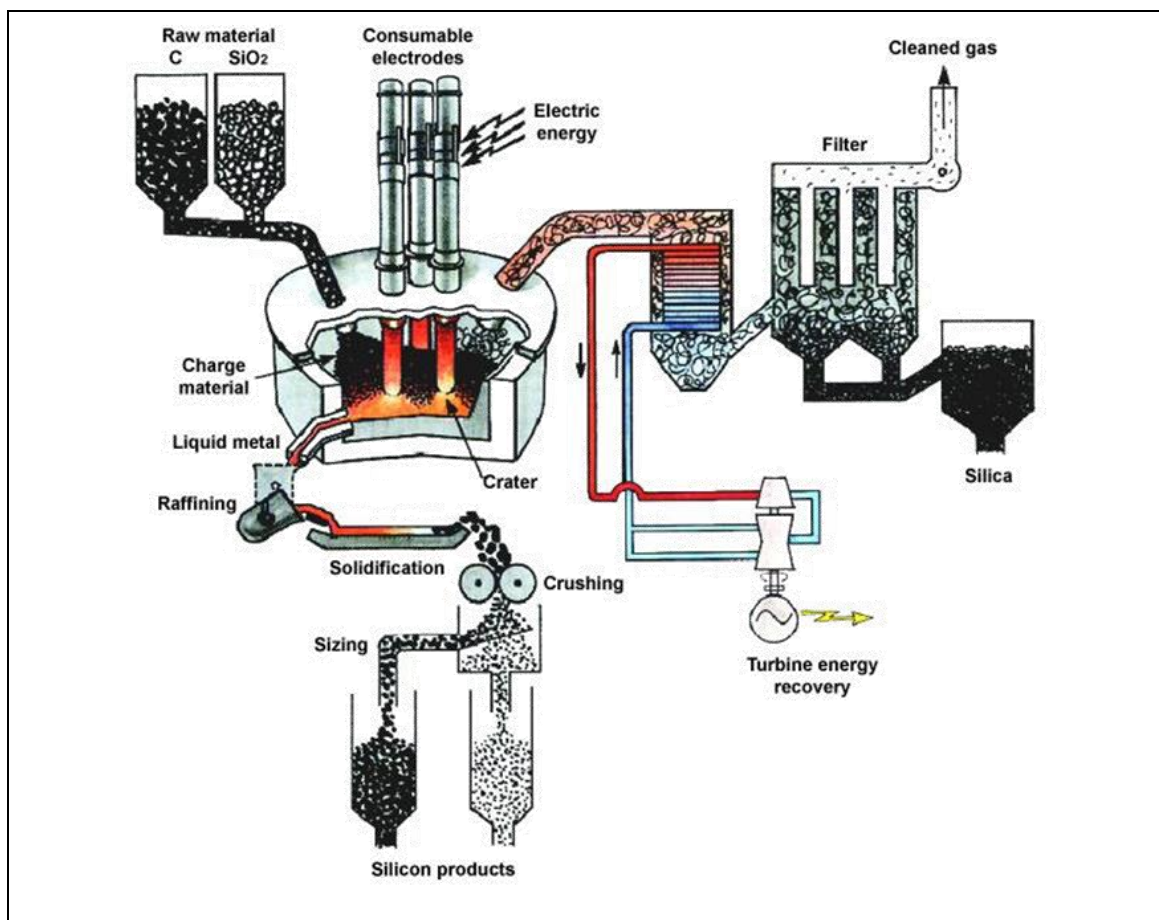

Figure 13.8: Electric reduction furnace process and auxiliary equipment

The raw material may be charged to the furnace in different ways. For smaller furnaces, the raw material can be charged by using a charging car. The charging car may sometimes also be used for the necessary stoking in order to break down crust formation in the upper part of the furnace charge. Large electric arc furnaces are normally charged by charging tubes where the charge flows from the tubes to the furnace charge level.

The electrical supply system will transform the electrical energy that is normally at high voltage down to the low voltage/high current level that is required for the process. The furnace transformers are normally situated symmetrically around the furnace in order to obtain electrical symmetry and short electrical connection lines to avoid unnecessary losses. Smaller, older furnaces sometimes use a single three-phase transformer. The operation of single-phase transformers has some advantages for the furnace control. The electrodes are connected to the electrical supply system through the busbar. The electrodes can be prebaked or of the Söderberg

variety. They are made from graphite or carbon material and are consumed in the process and have to be replaced continuously.

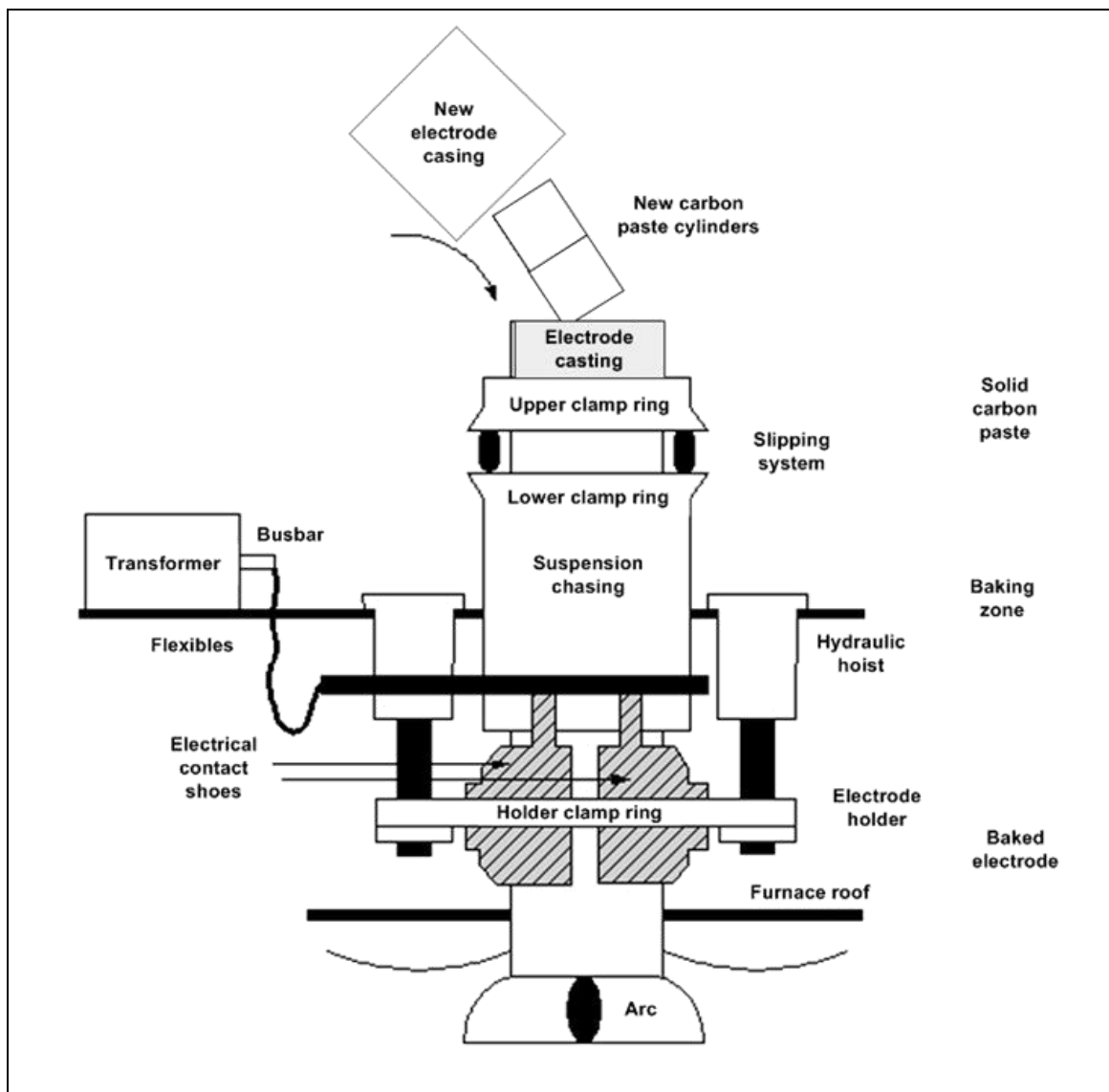

Figure 13.9: Søderberg electrode system in an electric arc furnace

The Søderberg system shown in Figure 13.9 is based on an outer steel electrode casing which acts as a mould for the carbon paste. The carbon paste is baked to a solid electrode inside the steel casing when the electrode is heated, passing the upper contact clamp area. The solid carbon electrode will be consumed in the furnace partly by thermal reaction and partly by oxidation. Significant concentrations of carbon monoxide can be produced. Some installations use hollow electrodes which allow material to be fed into the furnace through the electrode.

The raw material provides part of the resistance in the electrical circuit and promotes the formation of the electric arc, which produces the high temperatures needed. The depth of insertion of the electrodes regulates the resistance. Direct current arc furnaces exist and use anode pins or conducting hearths. The electric arc furnaces can be operated batch-wise or continuously.

The furnaces can be open, semi-closed or totally closed using feed chutes and sealing valves for charging. In the latter case, all of the furnace gases are extracted efficiently, cleaned and can be used as a source of fuel using the high concentrations of CO or to preheat feed materials using

the heat content [112, Outokumpu Oy (SF) 1998]. The hoods and occasionally the furnace body can be water-cooled to control the process and prevent damage.

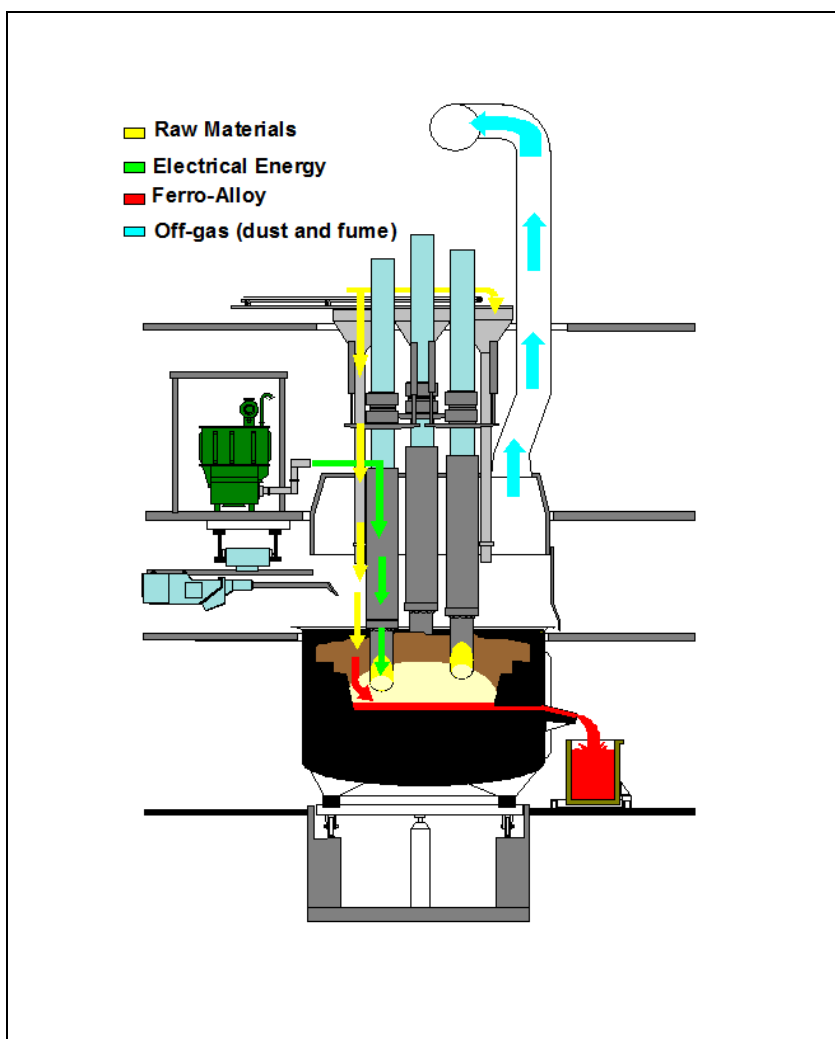

Figure 13.10: Rotary electric reduction furnace

Molten or solid raw materials are fed in a number of ways using launders, feed pipes or through a hollow electrode. Closed or semi-closed conditions are easy to maintain. In smelting processes, the roasted ore concentrates are transferred onto the liquid melt either through the top of the furnace or sideways by individual chargers and the electrodes are immersed in the molten slag layer.

These furnaces are used for smelting a range of ferro-alloys and can be used to preheat or pre-reduce material to exploit the CO content. They are also used for melting and refining refractory metals and high-temperature alloys and, in these cases, they are operated under vacuum.

13.1.2.4 Electric (resistance) furnaces

This type of furnace uses a similar arrangement to the electric reduction furnace. Depending on the size of the furnace, three to six Søderberg or prebaked electrodes are immersed in the liquid layer. The melting temperature is maintained by means of electric resistance heating. The furnace is usually operated continuously. The furnace is shown in Figure 13.11.

Molten or solid raw materials are fed in a number of ways using launders, feed pipes or through a hollow electrode. Sealed or semi-sealed conditions are easy to maintain. In smelting processes, the roasted ore concentrates are transferred onto the liquid melt either through the top of the furnace or sideways by individual chargers and the electrodes are immersed in the molten slag layer.

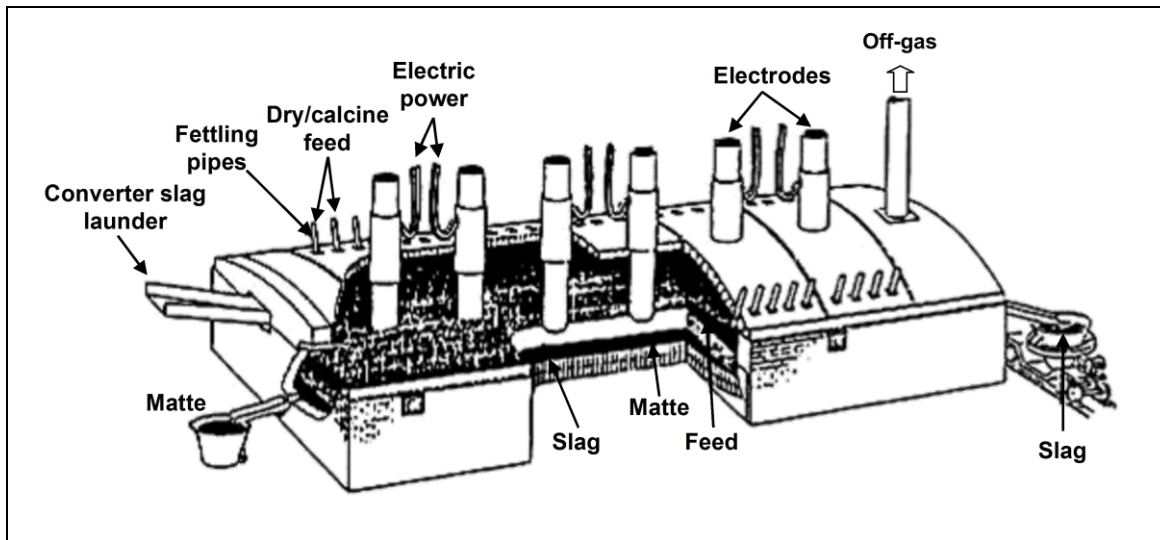

Figure 13.11: Electric furnace for concentrate or calcine smelting

Electric furnaces can be operated in a number of ways using coke (as reducing agents) and slagging agents depending on the application. The carbon electrodes are consumed as oxides and are reduced but the gas volumes produced during operation are kept to a minimum as there are no gases produced by the combustion of a fuel. The heat required for smelting is generated exclusively by electrical energy, which is introduced by electrodes immersed in the molten slag which acts as electrical resistance. These furnaces are usually sealed and the gases are easily collected and treated to remove and, if possible, to reuse dust, CO and sulphur dioxide.

These furnaces are used in the production of a number of metals from primary and secondary raw materials including precious metals, lead and copper and can also be used for slag cleaning [121, Rentz, O. et al. 1999]. Some slags from primary smelting, e.g. copper, are usually cleaned in circular furnaces. They are also used for the recovery of precious metals, particularly silver.

When secondary raw materials are used, the burden is prepared with a composition to suit the specific smelting programme and is fed to the furnace via an enclosed charging system. The molten products are drawn off into buckets or ladles via different tapholes. Reduction smelting results in the volatilisation of mainly zinc, tin and lead which are discharged as oxides with the off-gas and collected in the dust collection system which consists of a dust pot, process gas cooler and a filter.

13.1.2.5 Rotary furnace

The rotary furnace is described in Annex 13.1.1.1.

13.1.2.6 Refractory-lined pits and crucibles

Refractory-lined pits and crucibles are simple pits formed of Al_2O_3 or other refractory material and refractory-lined steel cylinders that are arranged to form crucibles. They are commonly used

for metallothermic reactions. Refractory-lined pits and crucibles are often used in the production of special ferro-alloys such as ferro-vanadium and ferro-molybdenum as well as for refractory metals. Fume collection can be a problem with this type of furnace and well designed and operated gas extraction is needed.

13.1.2.7 Ausmelt/ISASMELT furnaces and the KRS furnace

The Ausmelt/ISASMELT furnaces and the KRS furnace are cylindrical bath furnaces that use a steel lance for the injection of natural gas, oil or coal, and oxygen or air into the melt. The lance is submerged into the molten bath and relies on the formation of a coating of slag to prevent rapid deterioration. The furnace is shown in Figure 13.12.

Other raw materials are fed into the furnace by a sealed conveyor where they react at a high rate and are melted. The submerged combustion lance stirs the bath and produces a slag along with the desired metal or matte. The separation of the molten phases requires a separate settling furnace from where the phases are tapped separately. The furnace can be used on a batch basis when conditions in the furnace, such as the gas blown through the lance, are changed at the end of a batch. Examples of a batch operation are:

- the smelting of copper/lead secondary material to a copper lead matte in a first stage followed by conversion of the matte to blister copper by blowing with oxygen;
- the treatment of zinc leach residues.

Continuous operation is possible using two furnaces in series, e.g. as suggested for the ISASMELT lead production process.

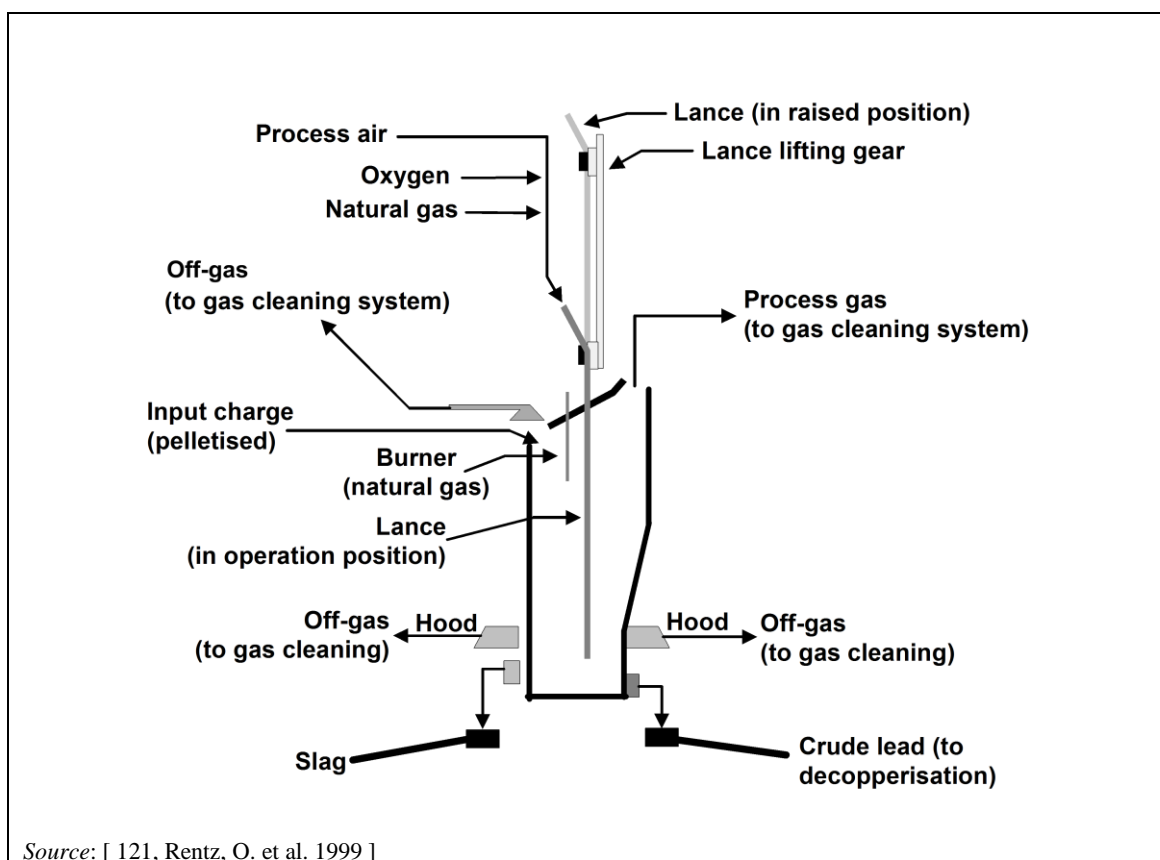

Figure 13.12: The Ausmelt (Sirosmelt)/ISASMELT furnace

The furnace uses a robust hood and an extraction system to collect and treat fumes from the furnace system and tapping operations. When sulphidic concentrates are smelted, the gases are passed to a sulphur removal system.

There are a number of applications for this type of furnace including the production of copper matte from concentrates and converting, production of copper from secondary raw materials (KRS), the production of lead from primary and secondary materials, the treatment of spent pot lining and the fuming of zinc [37, Ausmelt Ltd. 1995].

The Ausmelt/ISASMELT furnace is used as a continuous direct smelting furnace as well as for batch and stepwise operations. When smelting copper concentrate to matte, the process uses moist feed that is fed continuously with fluxes into the furnace.

Unlike the blast and electric furnace technologies, the KRS currently uses an intermittent two-stage process consisting of a smelting step and a conversion step. There are several furnaces operating this way. In the KRS process for example, the first step produces a metallic phase (black copper) and a slag phase which is drawn off via the slag taphole and granulated with water. The iron silicate sand produced is marketed as a building material. The black copper remains in the furnace. In a second step, the black copper is converted to a metal and a converter slag under oxidising conditions by adding alloy scrap. The converter slag is transferred via a launder to the tin-lead alloy furnace (rotary furnace) for further processing. The KRS converter metal flows to a rotating and tilting furnace designed for temperature-holding service from where it is poured into ladles and transferred to the anode furnace for pyrometallurgical refining. Final refining is accomplished in the copper electrolysis unit. The quality of the refined copper (cathode copper) measures up to that of copper won from primary raw materials [234, UBA (D) 2007].

13.1.2.8 Top-blown rotary converter (TBRC) and tilting rotary oxy-fuel furnace (TROF)

The TBRC and TROF are rotary and tilting furnaces that use lances for heating and blowing purposes. The furnaces are small and are housed in an enclosure to contain secondary emissions, which are treated. Rotation of the furnace promotes good mixing of the charge and complete reaction of the components but can lead to abrasion of the refractory lining. The furnace is shown in Figure 13.13.

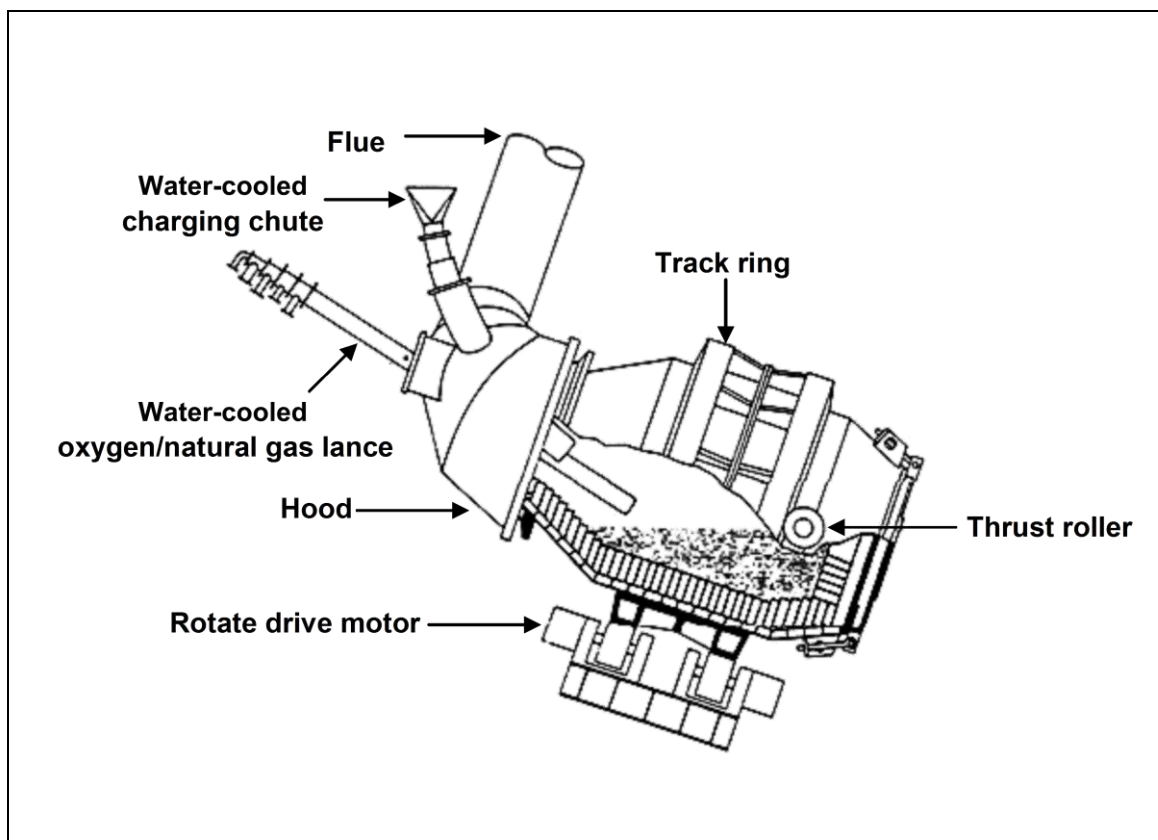

Figure 13.13: TBRC and TROF

Oxygen and fuel are added via the lances, which blow onto the surface of the melt. The use of oxygen results in the production of low off-gas volumes and high sulphur dioxide when sulphides are smelted. The process is normally carried out on a batch basis and it is common to use a number of these furnaces for smelting, converting and slag cleaning. It is used to produce primary and secondary copper and lead, and ferro-nickel and for the recovery of precious metals.

Other commercial designs of tilting rotary furnaces are also used for smelting and examples are the mini smelter.

13.1.2.9 The Noranda, El Teniente, Baiyin and Vanyukov processes

The Noranda reactor uses a cylindrical refractory-lined furnace for smelting. Pelletised concentrate and additives are charged onto the bath of molten slag at the top end of the furnace. Burners fired by natural gas or oil situated at both ends produce the heat necessary for processing. Oxygen-enriched air is blown into the molten bath through tuyères, causing sulphur and iron to oxidise. The Noranda reactor is shown in Figure 13.14.

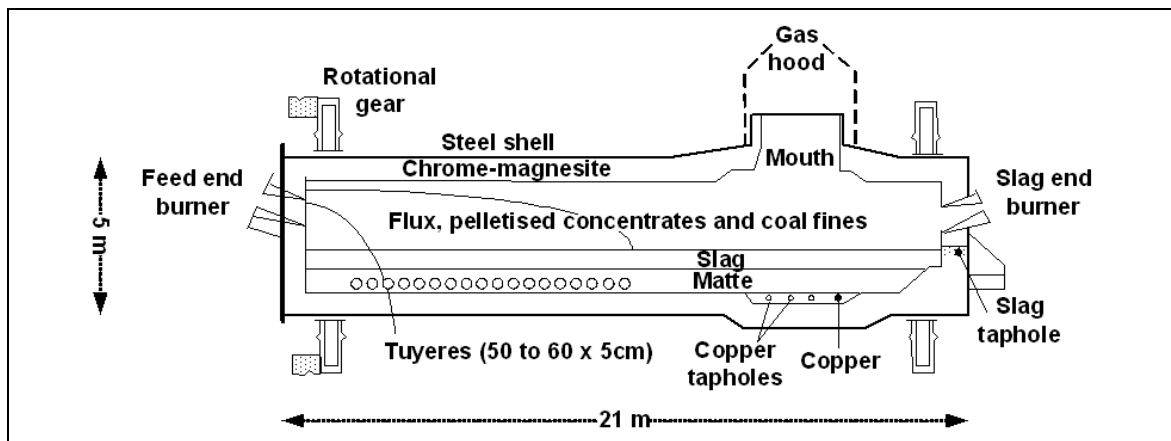

Figure 13.14: The Noranda reactor

During continuous smelting in the furnace, the melt segregates into two liquid phases: slag and matte. Due to their varying densities, they settle to form two layers. Matte is tapped periodically from the bottom of the furnace and the slag flows out continuously opposite the charging end. The furnace is sealed and equipped with an extraction system, and the launders are provided with extraction.

This process is used to smelt copper concentrates and can produce blister copper when using concentrates with low impurity levels or high-grade matte. The normal operating practice is to produce a copper-rich matte to undergo further conversion.

The El Teniente, Baiyin and Vanyukov processes are similar to the Noranda process. In the El Teniente process, wet concentrates are added to the furnace using a Gar gun and dry concentrates are added via the tuyères. Initially matte is seeded into the furnace to help the process and to produce white metal. The El Teniente reactor is shown in Figure 13.15. The Baiyin process uses a rectangular furnace that is divided into smelting and settling zones. In the Vanyukov process, the oxygen-enriched air is blown into the slag layer rather than the matte layer.

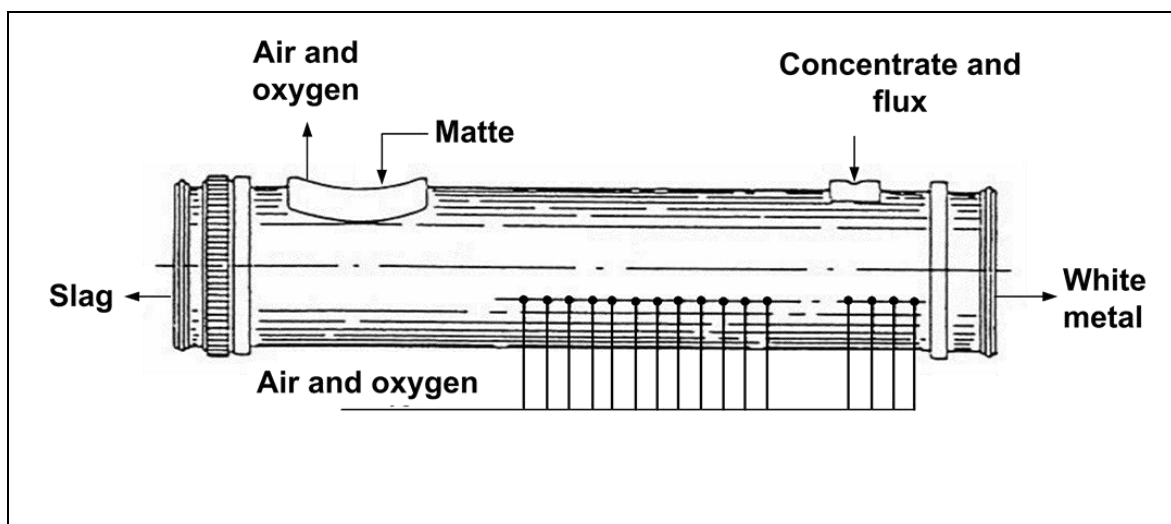

Figure 13.15: The El Teniente reactor

13.1.2.10 The Mitsubishi process

The Mitsubishi process employs three interconnected furnaces; a bath smelting furnace, an electric slag cleaning furnace and a converting furnace. Gravity flow is used between the furnaces and avoids transfer by ladle. All of the furnaces are sealed and equipped with an extraction system, heat from the process gases is recovered and treated to remove dust and sulphur dioxide. The furnace is shown in Figure 13.16.

The dried concentrates, air, oxygen and additives are charged into the bath furnace by means of lances and subsequently melted to form matte (60–65 % copper content) and slag. This mixture flows continuously through a channel into the electric hearth furnace that serves as a settling furnace to separate the slag. Matte is continuously discharged from the settling furnace through a siphon into the converting furnace.

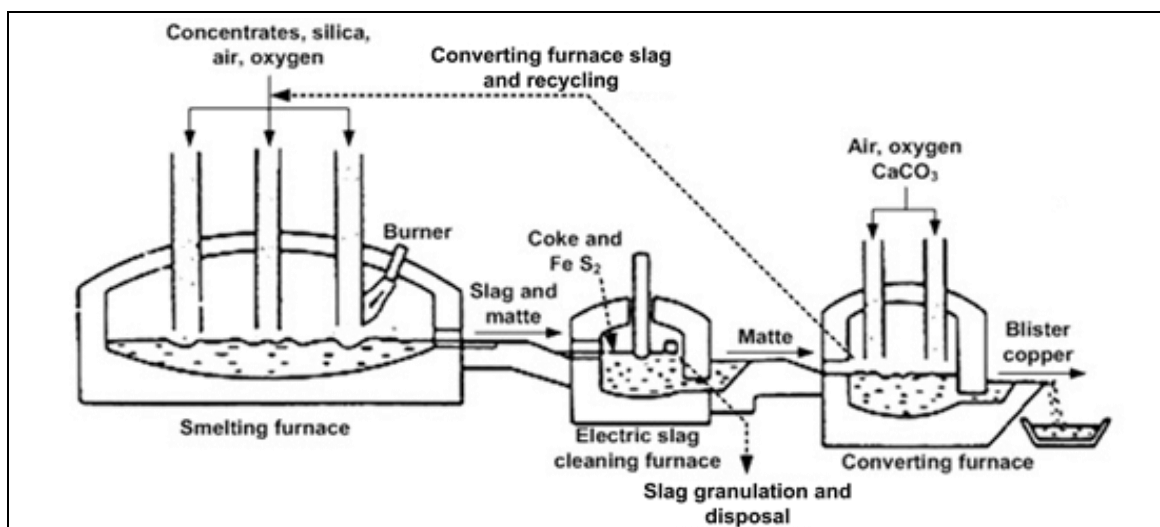

Figure 13.16: The Mitsubishi process

In the converter air, oxygen and additives are blown onto the liquid bath via water-cooled lances to produce blister copper. The converter slags are recycled to the smelting furnace, which can also be fed with anode scrap. It is possible that the converter stage could be used with other smelting furnaces. This process produces blister copper continuously.

13.1.2.11 The QSL furnace

The QSL furnace is a horizontal cylinder divided into an oxidation zone and a reduction zone. The furnace is lined with chrome-magnesite bricks to cope with a temperature of 1250 °C. Tuyères at the furnace bottom supply oxygen to the oxidation zone and a mixture of air and coal dust to the slag reduction zone. Primary and secondary raw materials are used and can be moist and sized from large lumps to fine material. They are fed into the top of the furnace mixed with coal to provide heat and reducing conditions and fluxes to yield a slag with a low melting point which can later be used as a construction material subject to quality control. The furnace is shown in Figure 13.17.

The oxidation zone produces lead bullion, sulphur dioxide and a lead-rich slag. This flows into the reduction zone so that more lead bullion is produced, and this flows in the opposite direction to the lead taphole. Slag is tapped from the reduction end and then granulated. Lead bullion is tapped from the oxidation end and then refined. Hoods and complete enclosures extract gases from the outlets and launders. The exhaust gases contain 10–13 % SO₂ and are used for heat

recovery and then dedusted in an ESP before passing to a sulphuric acid plant. Other process gases are cleaned in fabric filters.

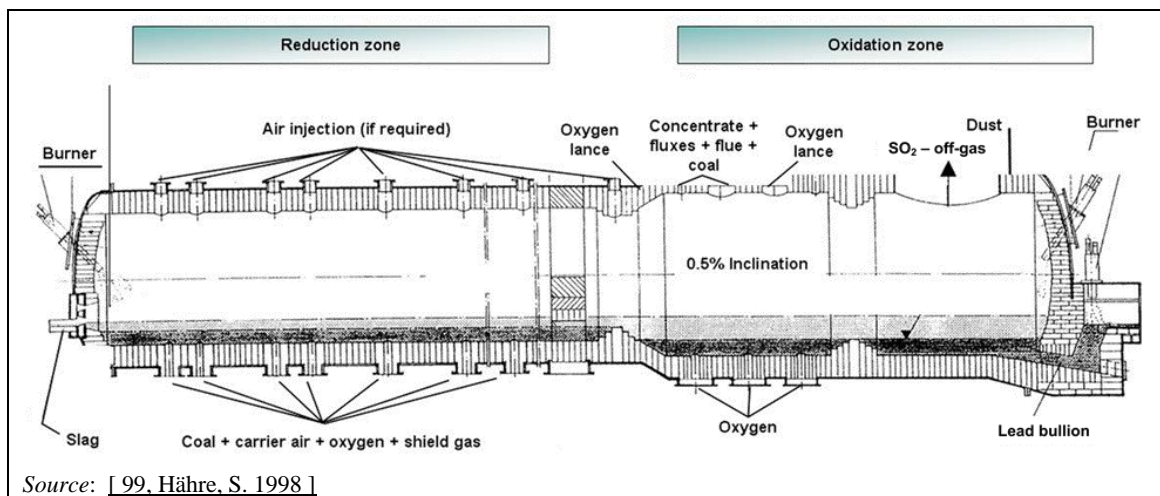

Figure 13.17: The QSL furnace

The QSL furnace was designed to produce lead from concentrates and some secondary materials in a single bath furnace and to maximise energy recovery.

13.1.2.12 Cyclone smelting furnaces

Cyclone smelting furnaces include the flame cyclone reactor (FCR) and the Contop reactor. With these high-intensity flash smelting processes, the copper concentrates and flux are smelted with oxygen in cyclone-type combustion chambers. In the Contop process, the cyclone is positioned vertically and the reacted mixture falls into a settling chamber below the cyclone. In the FCR process, the combustion takes place in a vertical reaction shaft and the separation of the matte and slag occurs in a further horizontal reactor. Slag and white metal or copper-rich matte are separated in the forehearth and tapped off. The white metal or matte is processed in a standard converter. The furnace is shown in Figure 13.18.

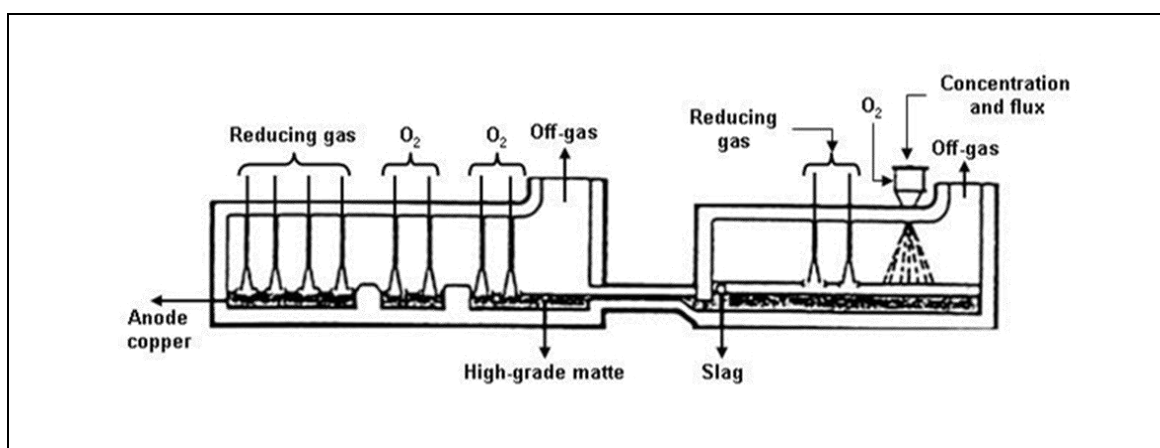

Figure 13.18: The Contop process

These processes are mainly used to smelt copper concentrates.

13.1.2.13 The Outotec flash furnace

The Outotec flash furnace is used for the smelting of dried concentrates by utilising the energy content of the concentrates for the production of the heat needed for the smelting of the concentrates and flux. The concentrate feed mixture is fed continuously with oxygen-enriched air through a concentrate burner into the vertical reaction shaft of a sealed furnace where the reaction between oxygen and concentrate takes place rapidly in suspension. The heat of reaction melts the particles. The fused particles produce matte and slag. Sulphur dioxide is formed at the same time. In older installations, process air preheating to about 200–800 °C was used to achieve autogenous operation, but the majority of installations now achieve autogenous operation by using oxygen enrichment to about 30–90 % oxygen in process air. The degree of oxygen enrichment is determined by the concentrate quality and the heat balance requirements. The continuous off-gas flow leaves the furnace through the uptake shaft for heat recovery and dust removal. It has a high, constant sulphur dioxide concentration and sulphur is recovered from the gas mainly by conversion to sulphuric acid after dust is removed. In some installations, oxygen is added to the uptake shaft for afterburning dusts and sulphatising air is fed into the boiler. It is possible to recycle weak acid into the uptake shaft under certain conditions, to decompose it so that the SO₂ generated can be recovered in the acid plant.

The molten slag and matte particles are settled out of the gas in a horizontal settler part of the furnace, forming a molten bath where the phases separate without an external settler. The matte is tapped out of the furnace to ladles or led via a launder to a granulation stage depending on the method of conversion used. The slag is tapped continuously or semi-continuously out of the furnace and can be further processed in a slag furnace or in a slag flotation circuit for copper recovery. In some installations the low copper content in the slag allows the slag produced in the primary smelter to be discarded or used directly.

The Outotec flash furnace is shown in Figure 13.19.

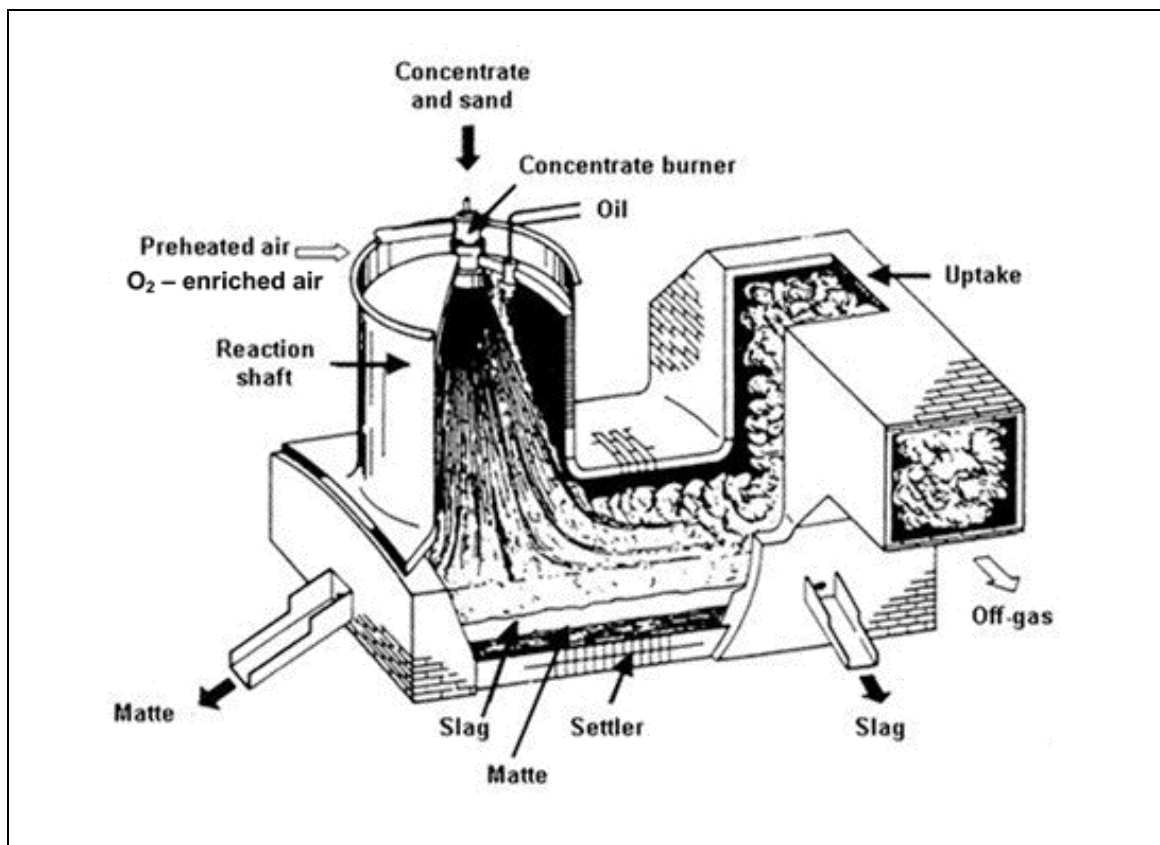

Figure 13.19: The Outotec flash furnace

The flash furnace is established for the production of copper and nickel matte. The furnace produces a high-grade matte and so the main part of the sulphur in the concentrate is released in the smelter gases and enables the conversion process (e.g. the discontinuous Peirce-Smith converter) to eliminate the remaining sulphur more easily.

This process is also used to produce blister copper directly from suitable concentrates which are low in iron, avoiding the need for a conventional converter that would produce additional sulphur dioxide. In this direct-to-blister process, the furnace slag contains a high copper concentration and so slag cleaning to remove this copper is an essential part of the process.

The furnace has been used on a demonstration scale for the production of lead bullion, for pyrite smelting and for fuming jarosite waste.

The same type of furnace is also used in the flash converting process for the conversion of ground, granulated matte into blister copper. The process has similar features to the flash smelting process, i.e. autogenous operation with oxygen-enriched air and a continuous flow of off-gas with a high sulphur dioxide content.

13.1.2.14 The INCO furnace

The INCO is a flash furnace similar to the Outotec flash furnace but it uses pure oxygen to operate autogenously. Copper ore concentrate blended with slagging agents is blown horizontally into the furnace from both ends and the off-gases are collected at the centre of the furnace.

The INCO furnace is shown in Figure 13.20.

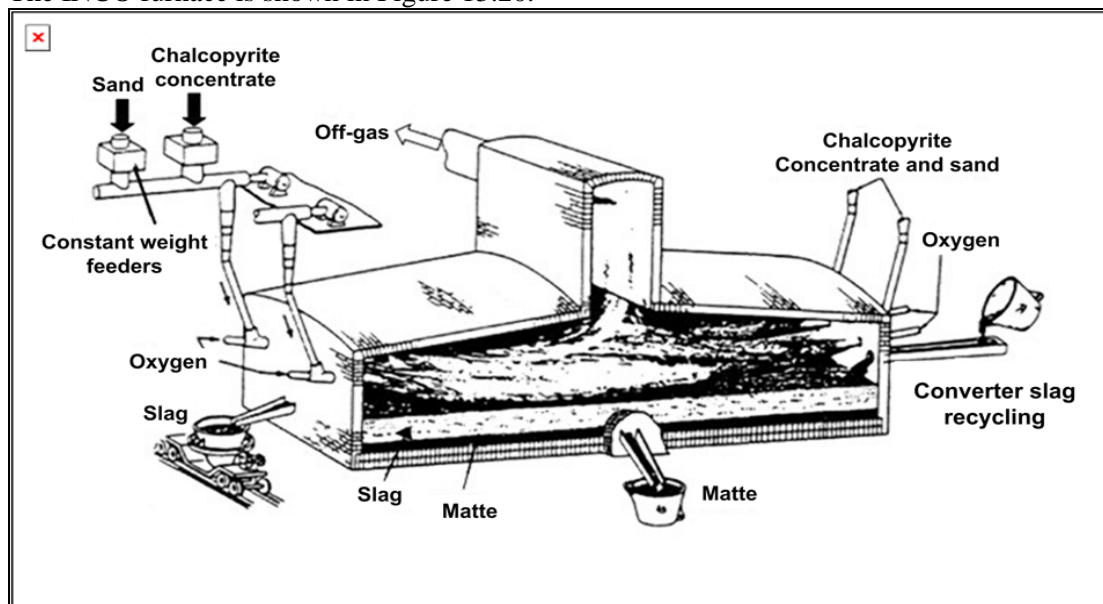

Figure 13.20: The INCO furnace

The concentrates are roasted and melted in suspension in the furnace and fall into the settler in the same manner as in the Outotec flash furnace. The heat produced by roasting is sufficient for an autothermal smelting process. The slag, which has a medium copper content, flows out continuously at one end of the furnace and the matte is tapped periodically at the centre of one side wall. The waste gas contains up to 75 % SO_2 .

13.1.2.15 The Kivcet (KSS) furnace

The Kivcet is a flash furnace similar to the Outotec flash furnace. Dry and blended charge components and oxygen are fed continuously through burners at the top into an oxidation shaft. At the same time, coke breeze is added. The furnace is shown in Figure 13.21.

The charge is ignited as it enters the reaction shaft, temperatures of up to 1400 °C are reached and complete desulphurisation takes place immediately. The coke breeze is only heated as it falls down the shaft. The coke floats on the slag bath and reduces lead oxide. Partly reduced slag and bullion flow under a submerged partition wall into the reduction section of the furnace, which is electrically heated and where additional coke or coal is added for final reduction.

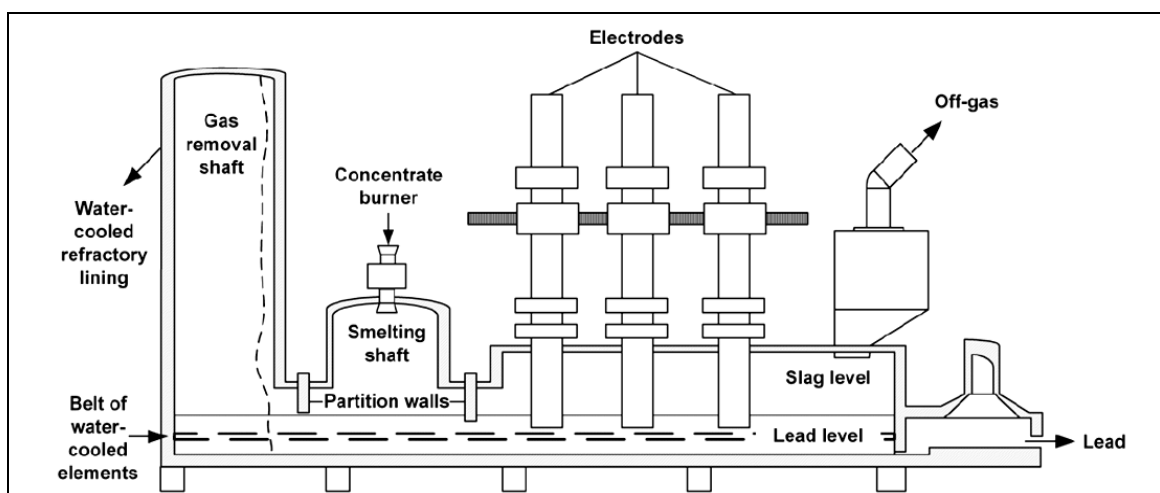

Figure 13.21: The Kivcet furnace

Lead bullion is sent for refining, the slag may be sent to a Waelz kiln, and the flue-dust from the oxidation is sent directly back to the furnace. The process is also used for copper production. The flue-dust from the reduction stage is treated in an ISF.

13.1.3 Converters

13.1.3.1 The Peirce-Smith converter

Peirce-Smith converters (PSC) are run batch-wise and use tuyères to blow air or oxygen into the matte so that it reacts in two stages to produce blister copper or high-grade nickel matte and slag. They are also used for refining ferro-nickel and to produce some metal oxides. Automatic slag quality control can also be used [329, Magnus and Olsson 2007]. This is by far the most common converting vessel and it is shown in Figure 13.22.

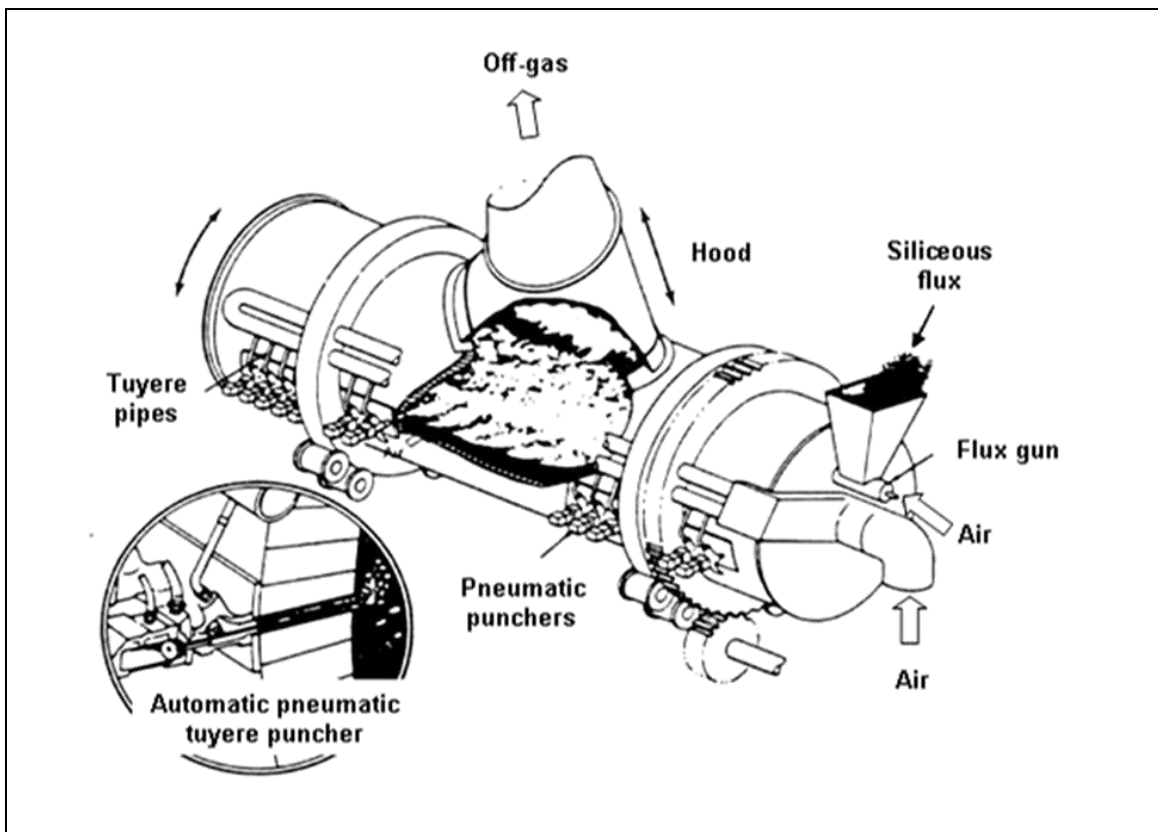

Figure 13.22: The Peirce-Smith converter

The converter can also be used for three different types of converter duties and as an anode furnace:

a) Matte converter

Large volumes of hot gases are produced during the blowing periods and are collected by hoods over the converter opening. The space between the converter housing and the hood allows the access of bypass air, which causes dilution of the SO₂-rich effluent gases. The SO₂ concentration varies depending on the process cycle. During initial blowing, SO₂ concentrations can be considerably higher than 10 %. However, during the subsequent blowing period, and when the converter is turned away from the hood, SO₂ concentrations are much lower and often nil. The varying SO₂ concentration does not provide a satisfactory feed to the acid plant, which requires a relatively steady flow. This is overcome in multi-converter plants by converter scheduling to attain a relatively steady flow. The gases can also be mixed with the much stronger smelter gases. The use of oxygen for enriching the blast air will also increase the SO₂ content; however, the enrichment is limited due to the rapidly increasing refractory wear. Water-cooled hoods are now being used in some plants.

The converter is charged via ladles with liquid matte and the slags produced during the conversion of the matte and the blister copper produced are subsequently poured into ladles from the converter. During these tapping processes, diffuse emissions are released. The use of additional fume extraction facilities (e.g. secondary hoods and air curtains) and the control of converter positioning to prevent blowing during the converter roll-out can reduce these emissions. Through-hood and tuyère charging systems are also used so that it is not always necessary to tilt the converter away from the hood during the charging of metal scrap and fluxes.

b) Scrap converter

In secondary copper melting, (Peirce-Smith) converters are distinguished into scrap converters and matte converters - both operated batch-wise. Scrap converters use coke and iron-rich materials as fuel and reducing agents respectively. In matte converters, the matte-borne sulphur is used as the energy source. Input materials for scrap converters include alloy scrap, suitable Cu-Fe scrap as well as (mostly liquid) black copper. The matte converter processes liquid copper-lead matte and copper-rich return slags, in some cases together with black copper - with the addition of solid copper scrap. Matte converter off-gas contains high SO₂ concentrations and is sent to a contact process unit for sulphuric acid production. This is why matte converters for secondary copper recovery are predominantly installed in primary copper production sites as these are equipped with sulphuric acid production units.

c) Alloy converter

The direct-to-blister flash furnace process produces a slag that is treated in an electric furnace to produce a lead-iron-copper alloy. This alloy is converted using a batch process in which the oxidised iron and lead pass into the slag phase and blister copper is produced.

d) Anode furnace

The PSC is also used as an anode furnace where the blister or black copper produced by the converter are refined. These furnaces use tuyères for further air blowing followed by the addition of a reducing agent (usually natural gas or propane) to remove the final traces of sulphur and then convert copper oxide to copper.

13.1.3.2 The Hoboken converter

The Hoboken converter operates on the same blowing principle as the Peirce-Smith converter but the large escape of gas that usually occurs when the converter is tilted for charging and tapping the slag and crude copper is avoided.

The effluent gas is sucked through the flue at the end of the converter. The siphon minimises gas escape during all phases of operation. The converter is charged through a small opening at the top of the casing and charging is therefore possible during blowing without tilting the converter because of the shorter process duration. Dilution of the effluent gases due to infiltrated air is small, so the steady average concentration of SO₂ is higher than for the Peirce-Smith converter. However, the SO₂ concentration will still vary throughout the cycle. The end result is that there is a smaller loss of SO₂ from the converter. The smaller opening used for charging can create problems due to slag build-up.

The Hoboken converter is shown in Figure 13.23.

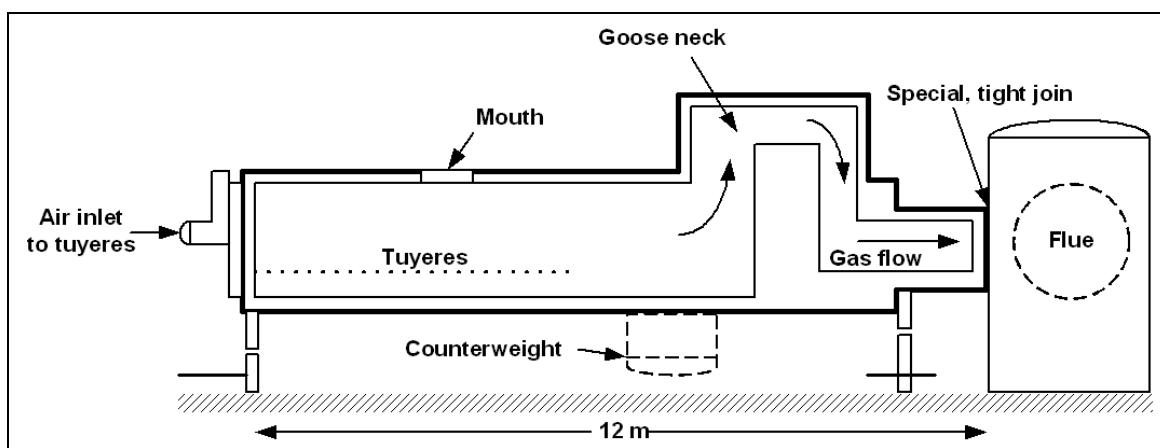

Figure 13.23: The Hoboken converter

13.1.3.3 The Kennecott-Outotec flash converter

The Kennecott-Outotec flash converter is also used and has been developed further since the 2001 NFM BREF was written. One installation is in operation in the USA and two in China (each producing about 400 000 tonnes per year of copper). A fourth installation is under construction in China. In this case, ground matte produced by a flash smelting furnace is used as the feed material. The Mitsubishi converting stage and the flash converter are the only continuous converters in metallurgy.

13.1.3.4 Other converters

The Ausmelt/ISASMELT furnace, the TBRC, the converter stage of the Mitsubishi process and the Noranda reactor are also used as converters. These furnaces use molten matte as the feed material and some may be operated continuously. The OBM converter is used for ferro-nickel.

The AOD converter is used for ferro-manganese production using oxygen for decarburisation and argon for degassing in the same manner as in the steel industry [[243, France 2008](#)]

13.1.4 Melting and refining furnaces

13.1.4.1 Induction furnaces

Induction furnaces are simple crucibles or channels that are heated by an external electrical coil. Channel induction furnaces are mainly used for melting items with large dimensions. In one case, the channel furnace is used to melt aluminium cans.

Two induction furnaces are shown in Figure 13.24.

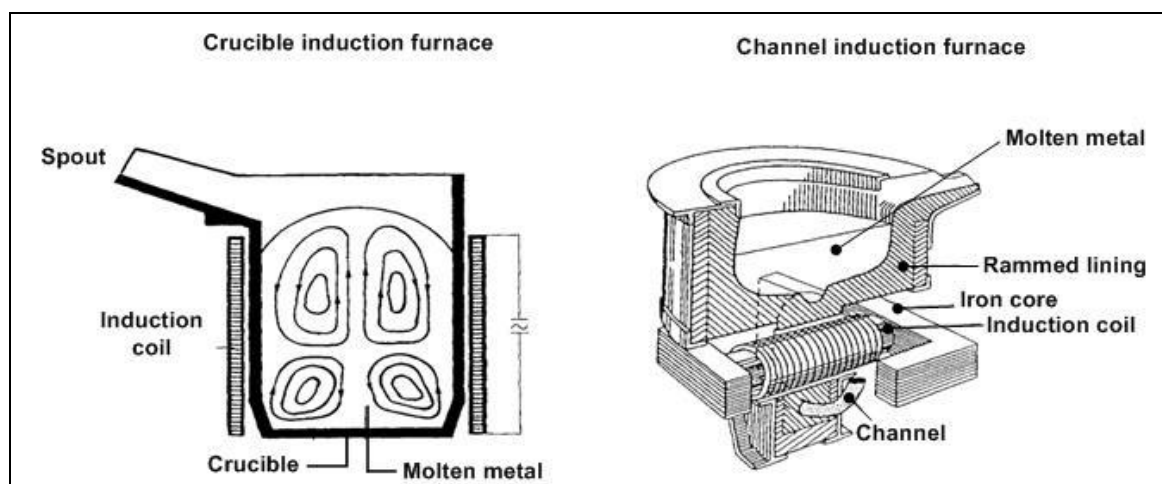

Figure 13.24: Induction furnaces

A current is induced in the metal that has been charged into the furnace and heat is generated. The furnaces are equipped with fume extraction hoods and dust abatement that can be used during drossing and pouring operations. Access to an induction furnace for charging and tapping means that a movable hooding system is often used. The hoods are robust so that they can withstand some mechanical impact. Alternatively, efficient fixed or lip extraction is used.

The efficiency of this furnace can be low for some materials but can be increased, particularly if the feed material is small. Large items can be cut to improve efficiency and also to allow the fume collection hoods to be deployed properly. Some continuous processes also retain a heel of molten metal in the bottom of the furnace between charges if the operation allows it.

These furnaces are used for small melting capacities of up to 30 tonnes, commonly for copper, brass, zinc and aluminium. They may also be operated under vacuum, for example when melting superalloys, high alloyed steel, and pure metals, and, in some cases, for metal distillation. The temperature of the furnace can be automatically controlled to minimise the production of fumes when melting volatile or oxidisable metals such as zinc or alloys that contain zinc.

These furnaces are also used to hold molten metal for alloying and casting. The current induced in these furnaces causes the metal to be stirred electromagnetically, which promotes mixing of the charge and any alloying materials that are added.

13.1.4.2 Indirectly heated kettles

Indirectly heated kettles are simple crucibles that are heated externally by the combustion gases from gas or oil combustion, by electricity or, for lower temperatures, by thermal fluid. Contact with a direct flame is avoided to prevent local hot spots at the base of the crucible and good

temperature control can be maintained in the melt so that oxidation and vaporisation of the metal are prevented.

These kettles are used mainly for melting impure lead and lead alloys and zinc and its alloys which do not contain plastic or other organic materials.

13.1.4.3 Shaft furnaces for melting metal

Shaft furnaces are simple vertical furnaces with a collecting hearth (inside or outside the furnace), and a material charging system at the top. Shaft furnaces can be used both for smelting metals and for producing metals from the reduction of other metallic compounds. If used for metal smelting, a burner system is present at the lower end. The burners are usually gas-fired and are designed to produce either an oxidising or reducing atmosphere. This allows the metal to be melted with or without oxidation. Independent control of the fuel to air ratio is usually provided for each burner. Continuous CO or hydrogen monitoring is also provided for each row of burners and monitors the combustion gases from each burner in turn. Combustion gases are usually extracted and cleaned.

If oily metal is fed into the furnace it passes through the temperature gradient that exists between the charging area and the burners. The low temperature can produce a mist of partially burnt organic material.

If used for the production of metals from the reduction of metallic compounds, the input material will often include materials such as scrap lead-acid batteries. These raw materials are then mixed with coke, fluxes, other metallic scraps and intermediates before being fed to the top of the furnace. At the bottom of the furnace, oxygen-enriched air is blown inside to ignite the coke, and to smelt and reduce the metals in the input material. Off-gases from the furnace are extracted and treated in an afterburner to decompose any carbon monoxide, oil, VOCs or PCDD/F left. The shaft furnace is energy-efficient since it preheats the charge material before reaching the hot smelting/reduction zone.

13.1.4.4 The Contimelt process

The Contimelt process comprises two interconnected furnaces, a hearth shaft furnace and a drum (or poling) furnace. The first is a vertical rectangular furnace with a horizontal collecting chamber which is fed with blister or black copper and other raw materials. Oxy-gas burners supply heat and the feed is melted to produce a fire-refined copper and a small amount of slag which is separated.

The Contimelt process is shown in Figure 13.25.

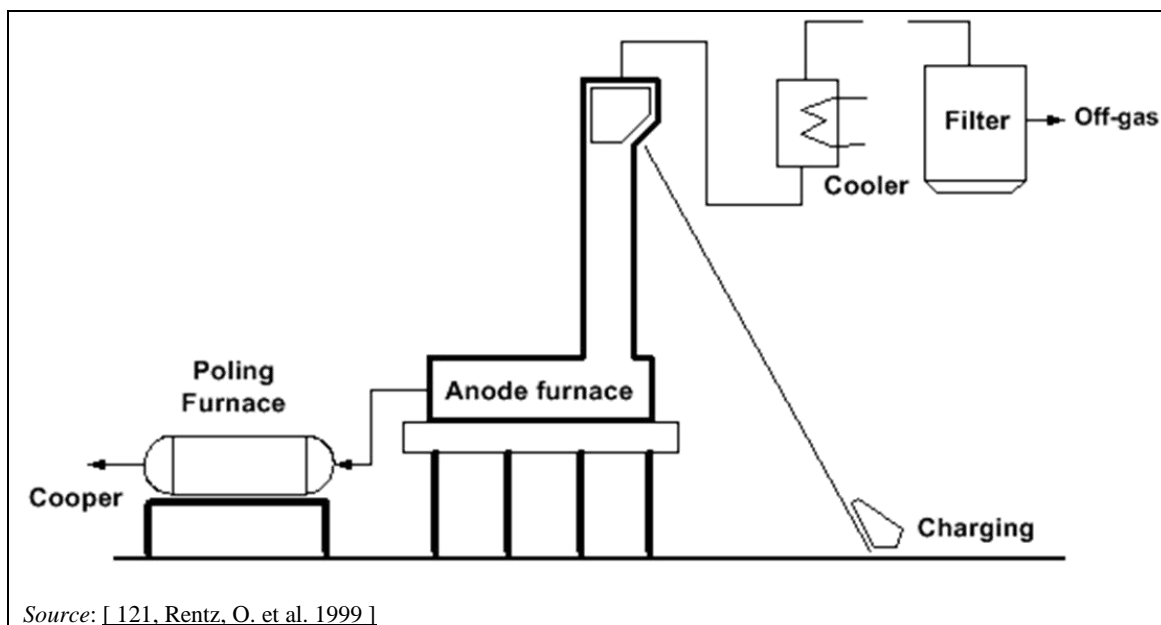

Figure 13.25: The Continelt Process

Molten copper flows via a siphon and a launder to a horizontal cylindrical furnace where it is deoxidised using natural gas. Refined copper is then cast as anodes. Gases from the second furnace are passed to an afterburner. They are then combined with gases extracted from the first furnace and pass to a waste heat boiler, burner air preheater, cooling stage and finally a fabric filter.

The furnace operating conditions can be controlled to minimise oxidation of the metal. The arrangement allows heat recovery by steam generation or charge preheating.

This is a continuous two-stage process to melt and treat black and blister copper, high-grade copper scrap and anode scrap to produce copper anodes. A similar development in the aluminium industry is the Meltower process [113, ALFED 1998]. This process uses a vertical melting tower and incorporates charge preheating using the hot exhaust gases.

13.1.4.5 Electron beam furnaces

The very high melting temperatures of refractory metals like tungsten and molybdenum, tantalum or niobium do not allow melting in a normal melting furnace. For high melting point metals, the electron beam furnace has been developed using accelerated electrons as an energy source to impart their energy into the furnace charge. The electron beam melting furnace is used to produce high-purity metals. The ability to melt high-purity metals is due to the perfectly clean high-temperature heat source (electrons) and the water-cooled copper hearth. The melted metal freezes against the copper so that the melt is only in contact with its own solid. Electron beam melting and refining is a well-established process for the production of ultraclean refractory metals.

13.1.4.6 Rotary furnace

The rotary furnace is a refractory-lined rotating cylinder fitted with a burner at one end. A charging door is provided at one end and the burner can sometimes be housed in this. Oxy-fuel firing can be used. The furnaces can be either long or short and several variants exist:

- short rotary furnace for the smelting of secondary lead, precious metals, etc.;
- long rotary furnace for the melting and recovery of aluminium scrap, etc.;

- Thomas furnace for the melting and refining of copper scrap, etc.;
- rotary furnace with submerged tuyères for the refining of blister or black copper, slag cleaning, etc.;
- tilting rotary furnace: for the melting and recovery of aluminium scrap, lead, dross, etc.;
- rotary/rocking furnace also called the Doerschel furnace used for the smelting of secondary lead.

Furnace rotation can be varied to give a complete reaction of the charged material and high efficiency. Raw materials are usually charged via an end door; this is usually enclosed and extracted to prevent fume emissions. The furnaces use oil or gas fuel and oxy-burners are commonly used. Heat from the burner is transferred to the refractory wall and the charge is heated by the refractory during rotation.

Slags and metal produced during the process can be tapped from a taphole at the door end or at the mid-point of the furnace. The taphole is orientated by partial rotation of the furnace to maintain the separation of the metal and slag. Tapping from the door end allows fumes to be collected from a single enclosure and extraction system. Tilting rotary furnaces are also used, they show improved recovery rates for some feedstocks and are less reliant on fluxes. A variety of metals can be smelted or melted in these furnaces.

13.1.4.7 Reverberatory (closed well) furnaces

The reverberatory furnaces are used for batch melting, refining and holding a variety of metals, particularly aluminium. They are refractory-lined, rectangular or circular bath furnaces fired by wall- or roof-mounted burners. They are often operated in a variety of configurations, sometimes with a sloping hearth where mixed metal objects can be placed and aluminium is separated from other metal components such as iron to prevent the contamination of the batch of aluminium. They can also vary in the number of wells or chambers that are used [[234, UBA \(D\) 2007](#)].

A variety of fuels are used and oxy-fuel burners can be used to increase the melting rate. Extraction and treatment of the combustion gases is used and the furnaces are partially sealed. Hoods and covered launders provide extraction during tapping and charging. Slag or dross can be removed by raking or by tapping.

Many designs have large access doors that allow large objects to be charged. This introduces the problem of sealing and extraction during charging. Water cooling of the doors can reduce this problem by reducing warping of the doors. Sealed charging carriages are used and charging pipes can be used for concentrates. In a similar manner, door sealing can be affected by material being incorrectly charged to the furnace. In some cases, spilt metal or slag can solidify in the opening or in other cases, wire or cable can prevent the doors from closing properly.

The melting efficiency of a reverberatory furnace is not usually high because of the poor heat transfer from the burner. Efficiency has been improved in practice by using oxygen enrichment or by using combinations of gas and solid fuel to extend the flame length. The use of regenerative burners reduces energy consumption significantly. Stirring of the contents using electromagnetic systems or pumps can also improve efficiency. The pumped systems can be operated with a side well to allow the melting of fine metal particles with minimum oxidation. The use of a reverberatory (bath) furnace for smelting is described in Annex 13.1.2.1

13.1.5 Summary of furnaces in common use

The furnaces used in these industries are summarised in Table 13.2, Table 13.3 and Table 13.4

Table 13.2: Drying, roasting, sintering and calcining furnaces

Furnace	Metals used	Material used	Comment
Steam coil dryer Fluidised bed dryer Flash dryer	Copper and some others	Concentrates	
Rotary kiln	Most metals for drying; Fuming ZnO; Calcining alumina, nickel and ferro-alloys; Burning film in precious metals; De-oiling copper and aluminium scrap Mercury removed from gas-cleaning precipitates.	Ores, concentrates and various scrap and residues	Drying, calcining and fuming applications
Shaft	Ferro-alloys (FeCr)	Lumpy furnace charge	Drying, devolatilising and preheating the furnace charge
Fluidised bed reactor	Copper, nickel, cobalt, precious metals, zinc and Al ₂ O ₃	Concentrates and Al(OH) ₃	Calcining and roasting
Updraught sintering machine	Zinc and lead	Concentrates and secondary raw materials	Sintering
Downdraught sintering machine	Zinc and lead	Concentrates and secondary raw materials	Sintering
Steel belt sintering machine	Ferro-alloys, manganese, chromium and niobium	Concentrates and fines	Other applications possible
Travelling grate Sintering machine	Ferro-alloys	Manganese fines	Sintering
Herreshoff	Refractory metals and molybdenum	Ores and concentrates	Roasting, calcining

Table 13.3: Smelting and converting furnaces

Furnace	Metals used	Material used	Comment
Enclosed refractory-lined crucibles	Refractory metals and special ferro-alloys	Metal oxides	
Open pit	Refractory metals and special ferro-alloys	Metal oxides	
Pusher	Refractory metals	Oxides	
Batch	Refractory metals	Metals	
Vacuum	Lead, tin and refractory metals	Secondary raw materials, carbon	
Baiyin	Copper	Concentrates	
Electric arc	Ferro-alloys	Concentrates, ores, secondary materials	
Contop/cyclone	Copper	Concentrates, ores	
Submerged electric arc	Precious metals, copper and ferro-alloys	Slag, secondary materials, concentrates, ores	For the production of ferro-alloys, the open, semi-closed and closed types are used
Rotary	Aluminium, lead and precious metals	Scrap and other secondary raw materials	Oxidation and reaction with substrate
Tilting rotary	Aluminium Lead	Scrap and other secondary raw materials. Flue-dusts that contain lead and secondary material	Minimises salt flux use Flue-dust from primary copper production. Battery recovery
Rotary/rocking	Lead	Smelting of secondary lead	Also called the Doerschel furnace
Reverberatory and hearth/closed well	Aluminium, copper, lead and others	Scrap and other secondary raw materials	Smelting of oxidic copper material, refining
Vanyukov	Copper	Concentrates	
Ausmelt/ISASMELT/KRS	Copper and lead	Intermediates, concentrates and secondary raw materials	
QSL	Lead	Concentrates and secondary raw materials	
Kivcet	Lead and copper	Concentrates and secondary raw materials	
Noranda	Copper	Concentrates	
El Teniente	Copper	Concentrates	
TBRC (KALDO) and TROF	Copper, lead, tin and precious metals	Most secondary raw materials including slimes	
Mini smelter	Copper/lead/tin	Scrap	
Blast and ISF	Lead, lead-zinc, copper, precious metals, HC FeMn	Concentrates, most secondary	
INCO flash	Copper and nickel	Concentrates	
Outotec flash furnace	Copper and nickel	Concentrates	
Mitsubishi process	Copper	Concentrates and anode scrap	
Peirce-Smith	Copper (converter), ferro-alloys, metal oxide production	Matte and anode scrap	
Hoboken	Copper (converter)	Matte and anode scrap	

Outotec flash converter	Copper (converter)	Matte	
Noranda	Copper (converter)	Matte	
Mitsubishi	Copper (converter)	Matte	

Table 13.4: Melting furnaces

Furnace	Metals used	Material used	Comment
Induction	Most	Clean metal and scrap	Induced stirring assists alloying. Vacuum can be applied for some metals
Electron beam	Refractory metals	Clean metal and scrap	
Rotary	Aluminium and lead	Various scrap grades	Fluxes and salts used for complex matrices
Reverberatory (also known as hearth or closed well)	Aluminium (primary and secondary)	Various scrap grades. (An additional side-well can be used for fine metal particles)	Bath or hearth configurations can vary. Melting or holding metal
Contimelt	Copper		Integrated furnace system
Shaft	Copper	Copper cathode and clean scrap	Reducing conditions
Drum (Thomas)	Copper	Clean copper scrap	Melting and fire refining
Heated crucibles (indirectly heated kettles)	Lead and zinc	Clean scrap and raw metal	Melting, refining and alloying
Directly heated crucibles	Precious metals	Clean metal	Melting and alloying
Submerged electric arc	Ferro-alloys (FeCr, FeMn, SiMn)	Lumpy ore, pellets, sinter, slag and secondary materials	

13.1.6 Electrochemical processes

13.1.6.1 Electrowinning

In electrowinning, an electrolytic cell is used consisting of an inert anode of lead or titanium and a cathode, placed in an aqueous electrolyte comprising the metal solution. The cathode is either a thin blank of pure metal (starter sheet) or a former sheet made from stainless steel or aluminium (permanent cathode plate). Metal ions pass from the solution and are deposited onto the cathode, and gases such as chlorine or oxygen are generated at the anode. Chlorine is collected in a sealed anode compartment but oxygen is usually released and may entrain some of the electrolyte and produce an acid mist, which may need to be collected and returned to the process. Cell hoods and gas-cleaning equipment or the use of beads or a foaming agent are needed to prevent mist from entering the workplace or environment. Depleted electrolyte is normally returned to the process.

Copper, cobalt, nickel, tin, zinc and precious metals are produced in this manner. When using permanent cathode plates, the pure metal deposits can be stripped or scraped off, melted and cast into the required shapes.

13.1.6.2 Electrorefining

In electrorefining, an electrolytic cell is used consisting of a cast anode of the metal to be refined and a cathode, placed in an electrolyte comprising the metal solution. The cathode is either a thin blank of pure metal (starter sheet) or a former sheet made from stainless steel (permanent cathode plate). Metal ions are dissolved from the impure anode and pass into the solution from where they are deposited onto the cathode.

Copper, precious metals, lead and tin are refined in this manner. When using permanent cathode plates, the pure metal deposits can be stripped or scraped off, melted and cast into the required shapes.

During electrorefining, other metals contained in the anodes are separated, less noble metals are dissolved in the electrolyte and more noble metals like the precious metals, selenium and tellurium form an anode slime that settles in the electrolytic cells. Anode slimes are periodically removed from the cells and the valuable metals are recovered. In some cases, anode bags are used to contain the slimes.

A portion of the electrolyte is bled from the system and other metals recovered from it.

13.1.6.3 Molten salt electrolysis

In molten salt electrolysis, an electrolytic cell is constructed using inert cathodes and anodes (steel or carbon) so that the high electrolyte temperatures can be withstood. Molten metal is deposited on the cathode and is removed periodically by vacuum or displacement. Gases such as chlorine or oxygen are evolved at the anode; chlorine is collected and recycled or sold. For aluminium, oxygen reacts with the carbon anode, which is continuously consumed.

Molten salt electrolysis can be used to produce aluminium, lithium, sodium and magnesium.

13.1.7 Hydrometallurgical processes

Acids and NaOH, sometimes also Na_2CO_3 , are used to dissolve the metal content of a variety of ores and concentrates before refining and electrowinning. The material to be leached is usually in the form of the oxide, either as an oxidic ore or an oxide produced by roasting [134, Metallurgical Consulting Traulsen GmbH 1998]. Direct leaching of zinc concentrate is also done at both elevated and atmospheric pressure.

Some copper sulphide ores can be leached with sulphuric acid or other media sometimes using natural bacteria to promote oxidation and dissolution, but very long residence times are used. Air or oxygen or chlorine can be added to leaching systems to provide the appropriate conditions, and solutions that contain ferric chloride are also used. The HydroCopper® process and similar processes have been developed to extend the range of ores and concentrates that can be treated by hydrometallurgy [308, Haavanlammi 2007].

The solutions that are produced are treated in a number of ways to refine and win the metals. Common practice is to return the depleted solutions to the leaching stage, where appropriate, to conserve acids and alkaline solutions.

13.1.7.1 Heap leaching

Open heap leaching is usually carried out at the mine. Material is crushed and ground to allow intimate particle-acid contact and is then formed into natural heaps on an impervious liner. Acid is sprayed onto the heaps and percolates through the mass [127, Chadwick, J. 1994]. It is collected on the liner and is recirculated to allow the metal content to build up. The leaching time of a single heap can vary from 100 days for copper oxide ore to 500 days for copper sulphide ore.

Bacteria can be used to enhance the leaching process and improve efficiency and this technique is used for some nickel ores where zinc, cobalt and copper are leached simultaneously and then separated prior to metal recovery [284, Riekkola et al. 2008].

The advantages of bio-heap leaching are that:

- it is based on a naturally occurring process, the bacteria promote leaching of metals from ore to solution;
- irrigation and aeration are the only additional processes;
- the capital and operating costs can be substantially lower than in traditional smelting and refining processes.

13.1.7.2 Atmospheric leaching (open tank)

Atmospheric leaching of oxides and concentrates is carried out in open or partially enclosed tanks by recirculating the mixture to maintain the temperature and acid concentration. The system is usually operated in a number of tanks in series. This is followed by sedimentation to separate the residue and purification and winning of the metal solution. Some leach residues can be leached further when the acid strength and temperature are increased. The use of a number of leaching stages can improve the leaching efficiency but can result in the dissolution of more impurities, particularly iron, which subsequently should be removed. The addition of oxygen and mixing it with the leachate by agitation can enhance the process.

13.1.7.3 Pressure leaching (autoclaving)

Pressure leaching or autoclaving can be carried out as a complete leaching process or as part of a series of leaching stages. Acid- or alkaline-resistant pressure vessels are used and liquor is recirculated to allow the reactions to proceed. Pressure leaching is also used to leach black copper to separate copper from other metals including precious metals.

Oxygen, air or chlorine can be added to increase oxidation. Pressure reduction stages can result in the production of acid mists and they are designed to contain them.

13.1.7.4 Solvent extraction

In solvent extraction, metals can be extracted from aqueous solutions with certain organic solvents that are insoluble in water. The aqueous and organic phases are mixed and by controlling the pH of the mix and the complexing agent used, the target metal is selectively extracted into the organic phase. After phase separation, a pure metal solution is obtained by re-extracting the metal from the organic phase into a secondary aqueous phase (stripping), from which the metal can be won in different ways [309, Pekkala 2007], Figure 13.26 shows the principle for such a process to produce copper. Other metals such as cobalt and zinc can also be produced in this way.

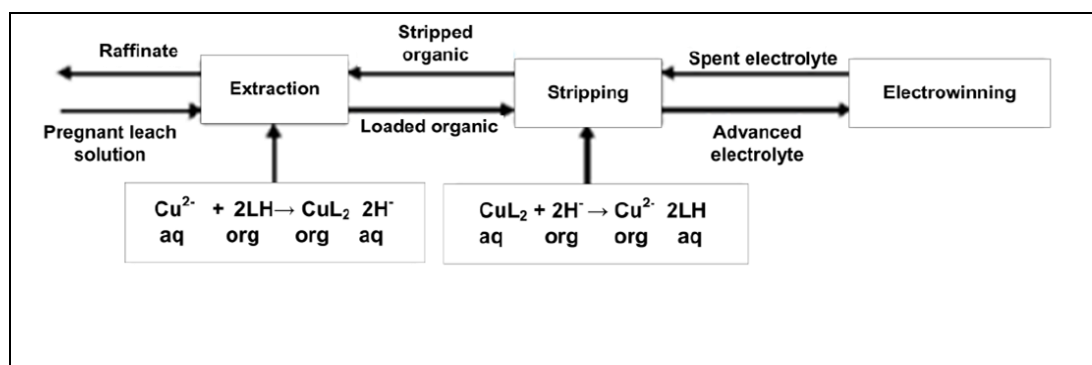

Figure 13.26: Solvent extraction (SX) processing stages

Solvent extraction can be used to selectively concentrate and purify solutions that contain zinc from either primary or secondary raw materials. The result is a pure zinc solution that can be used to produce SHG zinc after electrolysis or pure zinc sulphate, zinc oxide or other zinc chemicals.

The Zincex process originally used two different solvent extraction circuits, the first uses an anionic extractant, a secondary amine (Amberlite LA-2), and the second uses a cationic extractant, di-2-ethylhexyl-phosphoric acid (D2EHPA), to separate zinc from impurities and also increase the zinc concentration to produce a pure zinc sulphate electrolyte. The process has been simplified and enhanced to use only one solvent extraction cycle with D2EHPA and is integrated in the three main stages of leaching, solvent extraction and electrowinning [327, Gnoinski et al. 2008].

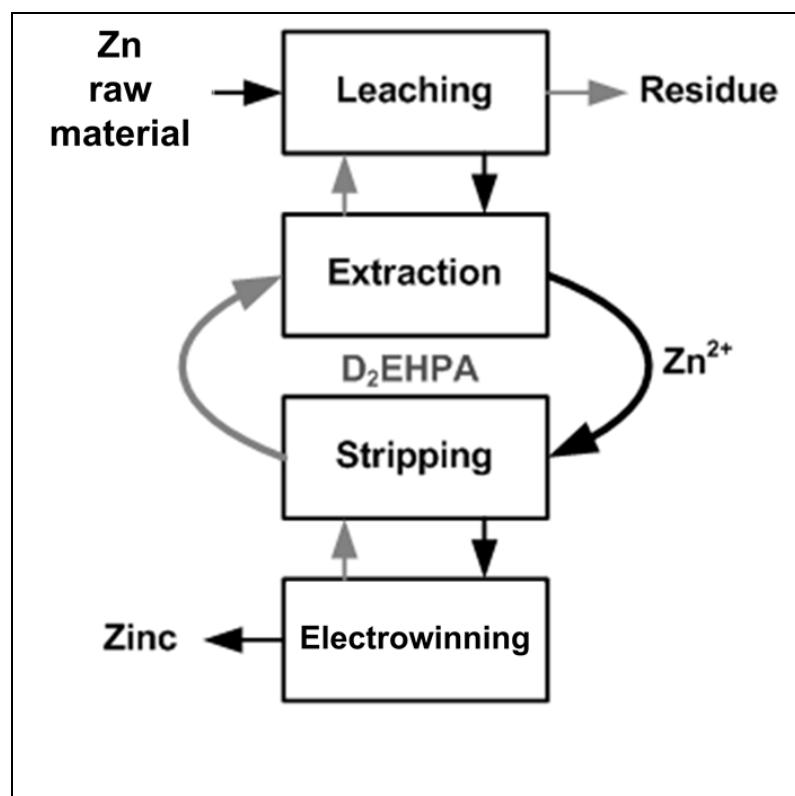

Figure 13.27: Process diagram of the modified Zincex process

When applied to primary zinc ores and concentrates, the process involves atmospheric leaching of the raw material, upgrading and purification of the pregnant leach solution by solvent extraction (SX), and zinc recovery by electrowinning (EW). The SX stage is also used to recover zinc from dirty secondary raw materials such as batteries.

13.2 Environmental monitoring practices

In several countries, production sites have mandatory measurement programmes covering the environmental impact on the surroundings of the production unit [226, Nordic Report 2008] [226, Nordic Report 2008]. In other cases, measurements are carried out by local authorities or by industry as part of larger research studies financed by parties other than the production site [237, UBA (A) 2004]. As discussed in Sections 2.3.5 and 2.4 on diffuse emissions, studies of the environment such as air dispersion modelling, reverse air dispersion modelling, air transportation models or studies of the water flows are commonly used to help identify potential sources of components in the environment from captured or diffuse emissions and differentiate between them [269, Broom 2005]. The fourth Air Quality Daughter Directive requires environmental monitoring of air for certain substances by local authorities and if the location of the monitors is suitable then these results can be used in the assessment of emissions provided that the substances are specific to the industry concerned. A comprehensive monitoring programme is also required to monitor the quality of the receiving waters in response to the EU Water Framework Directive (2000/60/EC).

The aims may be to measure certain components such as metals in the surrounding air, water or land or the deposition of dust. Biological or health effect surveys or accident warning systems can also be applicable.

13.2.1 Examples of environmental monitoring practices

13.2.1.1 Examples from the Nordic countries

Air monitoring

The example below [226, Nordic Report 2008] shows a brief summary of some aspects concerning air quality in the surroundings of a zinc smelter. In Table 13.5 the yearly average concentrations of some metals are shown.

Table 13.5: Yearly average metal concentrations in ambient air from a complex industrial area which includes a primary zinc smelter

Substance	Location relative to emission point	2003	2004	2005	2006
PM ₁₀ (µg/Nm ³)	2 km from complex	12	11	12	14
Zinc (ng/Nm ³)	2 km from complex	NA	13.3	NA	NA
Cadmium (ng/Nm ³)	2 km from complex	NA	0.14	NA	NA
Nickel (ng/Nm ³)	2 km from complex	NA	2.2	NA	NA
Arsenic (ng/Nm ³)	2 km from complex	NA	0.57	NA	NA

NB: NA = Not available.
 Source: [226, Nordic Report 2008]

In this case, the local authorities maintain an ambient air quality monitoring system and a cooperation contract exists between the different parties taking part in the air quality monitoring programme. The system includes four measuring stations at distances of 2–4 km from the plant. A TEOM 1400a is used as the PM₁₀ collector and analyser and is working on a fully automatic continuous basis. It is based on a filter-based direct mass measurement method. Every five years, particles for metal analysis are collected with an accessory ACCU system over a two-week period.

At the measurement stations, several other parameters are also measured such as SO₂ and NO_x. All analysers work automatically and continuously. The analysers are calibrated four times a

year by an external expert. Results from monitoring stations are transferred automatically to a computer located in the office of the municipal environmental authority. The authority collects the data, reports to participants and communicates with different interested parties.

The land-sea wind effect may influence the results in spring and autumn significantly. Emissions in spring and autumn from the land and sea are deposited near the site and the measured concentrations here are usually higher than in normal situations.

In some plants, a broad bio-indicator study is performed regularly to assess the effects of emissions on the surroundings. This study also includes a survey of metals in dust and a survey of airborne metal concentrations in the soil. Sample points (about 100) in the bio-indicator and metal study are located at distances of 0.1 km to 30 km from the zinc smelter.

Water monitoring

A comprehensive monitoring programme is also set up for the quality of the receiving waters in response to the EU Water Framework Directive (2000/60/EC). The monitoring is based on an authority-approved and cooperative monitoring programme. In one example there are 18 sample points in the sea area. Samples for water quality analyses are taken eight times a year so that samples will be taken both in summer and winter (ice-covered season). The seawater monitoring programme includes many different environmental parameters, e.g. quality of seawater (salinity, pH, O₂, temperature, colour, P-total, N-total), biological survey (phytoplankton, bottom macrofauna, macroalgae, periphyton, fish) and metal survey (metal concentrations in fish, sediment and bottom fauna). The monitoring programme (sample collection, analysis and reporting) is carried out entirely by external experts.

Trends in environmental concentrations over time show the effect that improvements in standards have achieved. Figure 13.28 shows zinc concentrations in seawater near a zinc smelter over a 30-year period. This allows the competent authority to ensure that measures taken result in the reduction of emissions.

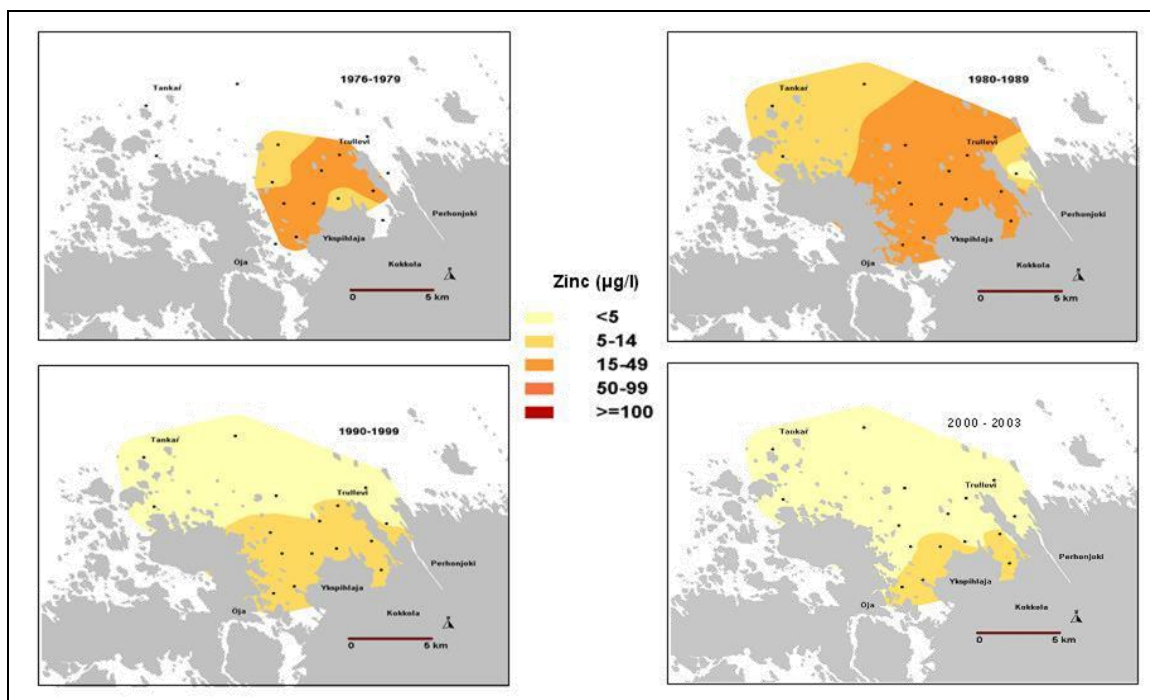

Figure 13.28: Trend of zinc concentrations in seawater over time near a zinc smelter

13.2.1.2 Examples from other countries

Similar practices are used in the UK where environmental samples are taken regularly, depending on the scale of the installation and the substances emitted, to establish the impact. Monitoring sites can be chosen based on the points of maximum environmental impact derived from air dispersion modelling. Samples of air, material deposited from air and from rain, soil and herbage are used to establish environmental levels and trends. Core samples of soil indicate the long-term deposition of pollutants while the analysis of grasses or crops indicate deposition during the growing season.

Potential sources of PM₁₀ near a steelworks were investigated and it was possible to examine the sampled particles microscopically or to use cusum sequential trend analysis to identify possible sources [269, Broom 2005]. In this case, it was possible to show that iron deposits came from ships offloading rather than from the furnaces.

There are a number of metals in air monitors around the emission sources of nickel in the upper Swansea Valley. In general, there is an upwind and a downwind pairing around each major source of nickel. The monitors have been operating for a number of years to give weekly ambient metal concentrations, which can then be used to calculate the annual mean levels of metals in the air around the sites. This work has shown ambient levels of nickel in the air to have dropped as a result of improvements in point source and diffuse controls. Analysis of the weekly data using pollution roses showed two sources of nickel in the area: one from the primary nickel producer and the second, a previously unidentified source of nickel, from a small metal production facility that uses nickel and other metals to produce a range of metal alloys and alloyed products [416, UK 2013].

In Germany, the local authority's air quality data and results from a monitoring point downwind of a smelter where the maximum ground levels of pollutants were predicted are being used to demonstrate the effect of process improvements [274, COM 2008]. Some results derived from environmental monitoring are shown in Figure 13.29 and show the reduction in environmental levels from 1989 to 2007.

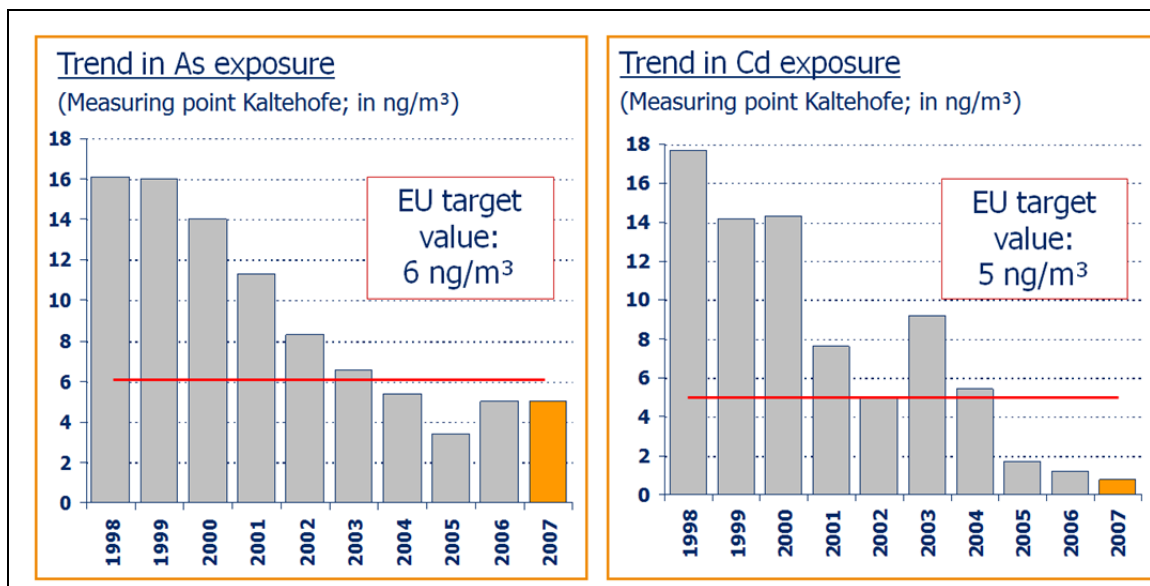

Figure 13.29: Trends of the concentration of As and Cd in the air measured at Elbe island in Hamburg (DE)

13.2.1.3 Studies in Austria

In Austria, emissions and deposition data from the town of Arnoldstein, including the testing of mosses near a smelter, have been analysed and the results show the reduction in impact as the site has been improved and cleaner processes have been adopted. Analyses of vegetables grown in gardens between 320 metres and 4700 metres from a secondary lead smelter have been performed as well as oil samples from cores to a depth of 10 mm [237, UBA (A) 2004], [328, Winter B., et al. 2009].

13.2.1.4 Studies in Belgium

In Flanders, the air quality in the area around the industrial sites near Hoboken has been determined for several years using a network of sampling stations. This allows the trends in emissions to be studied and the results from monitoring stations have also been used to perform reverse air dispersion modelling. The environmental concentrations of some metals are shown in Table 13.6, and the trends for lead in Figure 13.30 [335, VMM 2011].

Table 13.6: Environmental concentrations of some metals in PM₁₀ at sampling stations in Flanders

	Municipality/ district	Station code	Yearly average 2007 (ng/m ³)	Yearly average 2011 (ng/m ³)
Cd - target	Beerse	00BE01	28.5	12
	Beerse	00BE07	14.4	7.2
	Hoboken	00HB17	6.8	4.0
	Genk	00GK04	5.3	-
As - target	Beerse	00BE01	22.6	8.5
	Beerse	00BE07	12.4	5.8
	Hoboken	00HB01	31.1	14
	Hoboken	00HB17	25.3	23
	Hoboken	00HB23	49.0	41
	Hoboken	00HB18	15.2	8.8
	Hoboken	00HB19	12.2	NR
Ni - target	Genk	00GK02	34.9	21
	Genk	00GK03	32.9	17
	Genk	00GK04	81.4	NR
NB: NR=not reported Source: [335, VMM 2011]				

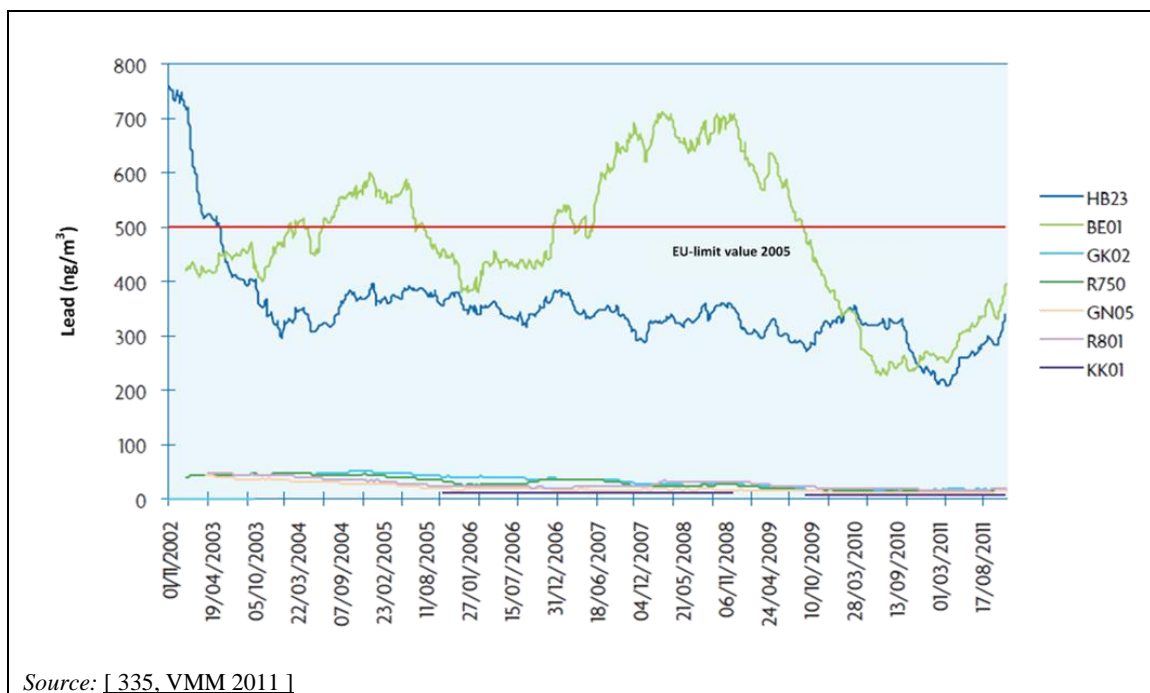

Figure 13.30: The trend in lead concentrations in PM₁₀ from 2002 to 2011 for some sampling stations in Flanders

13.2.2 Ecotoxicity and bioavailability

Since the original BREF was finalised, a lot of research and regulatory developments have taken place relating to assessing metals' toxicity and risks to the environment. These concepts and methodologies have been assessed and endorsed by EU competent authorities in the metals risk assessments carried out under the Existing Substances Regulation 793/93/EEC and have also been approved for use in the EU REACH Regulation 1907/2006/EC.

The concepts and methodologies are useful when assessing various site-specific environmental conditions and the effect metal concentrations may have on the environment (i.e. aquatic, sediment and soil). In terms of environmental monitoring, such a metal-specific risk assessment is particularly relevant as it gives details on how to carry out a bioavailability assessment of the various metals, recognising that the toxicity of metals is dependent on a number of parameters and abiotic factors (such as hardness).

The waste water of the non-ferrous metals industries is well characterised by measuring the concentrations of its constituents. The list of metals is relatively short, compared to the organic constituents which can occur in the chemical or other industry sectors. Several research projects have looked into the link between waste water composition and its ecotoxicity for algae. Models and methodologies for evaluating hazards, setting priorities, establishing environmental quality criteria, and monitoring and assessing the risks of chemicals are being developed and used in several jurisdictions. The majority of the compounds assessed are organic substances rather than inorganic metals and so the various methodologies and guidance documents provided for performing these assessments are lacking in detail on how to account for metal-specific attributes.

Questions related to the specific impact of metals on the environment and on human health have been raised. The need to establish ready and accessible metal-specific tools and data sets in order to make informed, science-based decisions has also been raised by representatives of local, regional, national and international administrations, as well as by members of non-governmental organisations, private companies and associations.

The Metals Environmental Risk Assessment Guidance (MERAG) was created by a consortium of researchers, metals associations, scientific panel reviewers and governmental reviewers (UK Government, Department for Environment, Food and Rural Affairs (DEFRA)). MERAG was further adapted into an annex for the specific needs of the EU REACH Regulation 1907/2007 (Technical guidance document, Annex 4 VIII 'Environmental risk assessment and risk characterisation for metals and metal compounds'). This metals annex has been reviewed and legally accepted by the European Chemicals Agency (ECHA) [301, MERAG 2007].

The guidance is divided into different fact sheets that provide the risk assessors/regulators with methodologies to be used in chemicals management and environmental quality standard setting for metals and to allow consideration of site-specific conditions by the assessor through the introduction of metal-specific concepts described in points 1 to 3 below.

1) Exposure assessment

The main objective of the exposure assessment is the derivation and evaluation of metal concentrations for each environmental medium (water, air, soil, sediment) that is potentially affected by human activities.

Metal concentrations in the environment are the result of the natural composition, historical contamination and the emissions associated with the use pattern and the complete life cycle of the metal (i.e. from mining to maximum separation and recycling of metals and disposal of the remaining waste). Due to the inherent variation of metal concentrations in the natural environment (e.g. different natural concentrations) and the variations of anthropogenic input, large differences in observed metal levels can be found in different locations.

Speciation is of paramount importance; metals can occur in different valences, associated with different anions or cations, and can be associated with adsorptive agents, such as dissolved organic matter (DOM) in water, or bound to minerals in sediment or soil. Therefore, speciation is highly dependent on the environmental conditions and chemistry of the site. The absorption/desorption behaviour of a metal depends greatly on the prevailing environmental conditions. The exposure assessment therefore goes beyond what is achieved by a simple direct toxicity assessment.

2) Effects assessment

The main goal is the long-term protection of the environment. Typical ecosystems that are considered for the inland environment are the aquatic (including the sediments), sewage treatment plants and terrestrial ones. For each of these, a predicted no-effect concentration (PNEC) should be derived. This PNEC is considered the concentration below which an unacceptable effect will most likely not occur.

MERAG provides guidance on the effects data selected for PNEC derivation to comply with the requirements (criteria) for data quality and data relevance. It takes into account the metal-specific considerations in permit setting (methodologies are provided on data quality selection, aggregation, interpretation, and on derivation of the PNEC value) [301, MERAG 2007]

The derivation of the PNEC value can take into consideration the (bio)available fraction of organisms for the specific environmental conditions of the site (toxicity models were developed to predict the bioavailability of metals for conducting risk assessments in the terrestrial, sediment and aquatic ecosystems). This possibility of taking into account the bioavailability of the metals is also provided for in Directive 2008/105/EC on environmental quality standards in the field of water policy and amending Directives 82/176/EEC, 83/513/EEC, 84/156/EEC, 84/491/EEC, 86/280/EEC and 2000/60/EC.

3) Risk characterisation

The guidance sets out a ‘building block’ approach to allow compliance with the permit conditions, and ensures, at the same time, that the best option for managing the potential risks presented by metals/metal compounds is considered. To this end, a tiered approach is advocated since data availability will depend to a large extent on the type of metal/metal compound under investigation, allowing for further refinement of the assessment.

In 2008, the refinement tools presented in the MERAG document were only applicable for metals that had sufficient data (e.g. nickel, copper, zinc). Tools are being explored for additional metals as the science is evolving (e.g. for silver, cobalt, aluminium).

The methodologies developed under MERAG are being implemented at the field level in various EU countries. Bioavailability models are also being further developed for a wider range of environmental conditions (e.g. marine and estuarine conditions).

13.3 Specific cost data for metal production and abatement

The data given in this annex focus on the process plant and main consumption figures. Site-specific cost factors have been eliminated as far as possible. The information gives an order of magnitude of the cost range and allows a limited comparison of costs between techniques.

Data are not available for all of the metal groups and so these data are presented as an annex so that some costs, e.g. for furnaces or abatement, can be referred to for these groups. Costs are mainly presented on the basis of cost per tonne of metal produced per year. Reference is made where possible to the size of the process or of the abatement plant so that the data can be used to provide rough estimates for sectors that may not be represented.

Several sources presented data and all give the specific investment cost per tonne of metal produced per year. The data were supplied in a variety of currencies effective at the time of purchase. For the sake of direct comparisons, these currencies have been converted into euros, using the exchange rate that was effective on 16 June 1999: USD 1.06 = EUR 1. The various exchange rates that operated since 1950 are given below so that the original costs can be derived if required.

Table 13.7: Some currency exchange rates

Year	DEM/GBP	DEM/USD	USD/GBP	DEM/EUR ⁽¹⁾	USD/EUR ⁽¹⁾
1950	11.76	4.20	2.80	-	-
1960	11.71	4.17	2.81	-	-
1970	8.74	3.65	2.40	-	-
1980	4.23	1.82	2.33	2.48	1.36
1990	2.88	1.62	1.79	2.07	1.26
1993	2.48	1.65	1.50	1.90	1.15
1996	2.35	1.50	1.56	1.90	1.27
1998	2.91	1.76	1.66	1.97	1.12
2008	NA	NA	1.992	NA	1.487

⁽¹⁾ Since 1979 only.

The cost data shown in this annex are an order of magnitude indication only.

Some sources also reported financing and operating costs for a particular installation. These may not be applicable to other sites because the costs of individual operations would include a substantial percentage of site- and corporate-specific cost components.

13.3.1 Influences on cost data

Some of the site-specific influences on costs referred to above are as follows:

- transport:
 - o feed material transport costs (effect on treatment and refining charge), transport costs for product(s);
- direct operating costs:
 - o labour legislation, climatic conditions, arrangement of unit operations (in-plant transport costs), energy availability, available infrastructure, special environmental protection requirements;
- sales costs:

- o market access, infrastructure, climatic conditions;
- capital costs:
 - o feed material shipment options, market access and market conditions/product sale, corporate structure;
- investment costs:
 - o climatic conditions, available infrastructure, energy and consumables, specific local environmental protection requirements.

The above factors indicate that it is very difficult to give reliable cost data which could be used in a more general sense without the danger of misleading results. A complete and reliable economic calculation/evaluation can only be done for a site-specific investment. Only on such a basis are definite cost data available. For example, the following factors have an overwhelming influence on the economics of a project and cannot always be estimated in this annex:

- treatment and refining charges for concentrates;
- costs for concentrates, flux, etc. and other purchases;
- purchase price (after deductions) of secondary materials;
- purchase price for refined metal;
- sale of by-products like sulphuric acid or similar;
- the selected country (taxes, labour, disposal and energy costs, inflation);
- the specific site (transport of pure materials and products);
- the infrastructure (availability of energy, water, oxygen, maintenance);
- the plant capacity;
- type and composition of feed;
- time schedule and time of investment;
- financing of the investment;
- costs for construction and erection (inland execution).

Where accurate costs are known for specific installations they have been included but they are provided separately so that site variation can be taken into account. Comments have also been made where possible to illustrate how cost variations, e.g. waste disposal costs, can account for a significant variation in the costs.

The capital cost of emission control measures and equipment varies with the type of plant. While in existing plants retrofit costs can be very high, integrated pollution control measures in new plants may be more cost-effective [234, UBA (D) 2007]. Factors governing the capital cost of a fabric filter system include:

- the off-gas volume to cleaned;
- the off-gas characteristics (dust and moisture content, temperature, presence of aggressive constituents);
- the need for additive dosing or flue-dust recirculation (additional piping, silos, conveying systems);
- available floor area for construction; type of construction (arrangement options, shallow or pile foundation, overall height, filter area, number of compartments, duct routing, etc.);
- the necessary stack height or need for stack lining (depending on off-gas composition);
- the necessary measuring equipment (platform, continuous monitoring equipment, access);
- extended scope of supplies (off-gas cooler, compressors, etc.).

Off-gases with low dust loads (e.g. secondary hood off-gases with fine dust loads $< 50 \text{ mg/m}^3$) normally require the addition of an additive (e.g. lime) to improve the dust collection efficiency. This not only drastically increases the raw gas dust load, but also the volume of collected dust

that should be disposed of. For moist and/or aggressive off-gases, the filter may have to be heated or provided with a corrosion protection coating.

The capital cost of a fabric filter designed for an off-gas flow rate of approximately 100 000 m³/h, including fan and filter media, was of the order of approximately EUR 650 000 (secondary hood off-gas with low dust load) or approximately EUR 950 000 (process off-gas with an elevated dust load). The total cost of a filter system including steel and concrete structures, ducting, stack and other equipment (see above) may amount to three or four times the capital cost of the filter.

Electricity consumption is the largest single contributor to the operating costs. Depending on the filter area, filter resistance, dust composition and concentration, the specific power consumption of a bag filter ranges from 2 kWh to 3 kWh per 1000 m³ of off-gas. If, due to the specific additive used, the dust collected in the filter system cannot be further processed for metal recovery and should be landfilled, the additional cost will be substantial.

13.3.2 Specific investment costs for copper process plants

As explained above, the investment costs for copper plants are also influenced by a number of site-specific factors and not only by the process technology and abatement techniques selected. Table 13.8 to

Table 13.12 give some technology-related data.

The tables indicate for greenfield plants:

- the year of investment or cost determination;
- the key plant sections covered;
- the production capacity related to the cost indication.

The normal plant-related abatement techniques are included in the cost indication. The investment costs are indicated as specific cost per tonne of copper. The cost data shown are to be understood as an order of magnitude indication. Costs for land, finance, inside and outside plant infrastructure, owner's costs during construction and all other investments which are not directly connected with the plant sections mentioned are not included.

Table 13.8: Primary copper smelter/acid plant complexes

Year	Installation cost (EUR/t production capacity/yr)	Product made and design capacity	Plant sections included
1977	2250–2450	Anode copper 70 000 t/yr	Material handling/storage, <u>partial roasting & electric furnace smelting</u> , PS converter, anode plant, EF slag cleaning, double catalysis acid plant
1980	2450–2650	Anode copper, 150 000–160 000 t/yr	Material handling/storage, <u>Outotec flash smelter</u> , PS converter, anode plant, EF slag cleaning, double catalysis acid plant
1981	1700–1850	Anode copper, 280 000 t/yr	Material handling/storage, <u>Outotec flash smelter</u> , PS converter, anode plant, EF slag cleaning, double catalysis acid plant
1981	2850–3000	Anode copper 100 000 t/yr	Material handling storage, <u>Mitsubishi continuous smelting</u> , anode plant, double contact/double absorption acid plant
1981	2250–2550	Anode copper 120 000 t/yr	Material handling/storage, <u>INCO furnace</u> , PS converter, anode plant, double catalysis acid plant
1992	2150–2250	Anode copper 150 000 t/yr	Material handling/storage, <u>ISASMELT furnace</u> , PS converter, anode plant, EF slag cleaning, double catalysis acid plant
1994	2250–2350	Anode copper 285 000 t/yr	Material handling/storage, <u>Outotec flash smelter</u> , <u>flash converter</u> , anode plant, double catalysis acid plant. Slag flotation not included
1995	2350–2750	Anode copper 120 000 t/yr	Material handling/storage, <u>Outotec flash smelter</u> , PS converter, anode plant, EF slag cleaning, double catalysis acid plant
1997	1950–2150	Anode copper 160 000 t/yr	Material handling storage, <u>Mitsubishi continuous smelting</u> , anode plant, double contact/double absorption acid plant
1998	2550–2650	Anode copper 303 000 t/yr	<u>Outotec flash smelter</u> , <u>flash converter</u> , anode plant, double catalysis acid plant
1998	2950–3150	Anode copper 200 000 t/yr	Material handling storage, <u>Mitsubishi continuous smelting</u> , anode plant, double contact/double absorption acid plant

NB: Original costs were in USD and have been converted using EUR 1 = USD 1.06.
Source: [90, Traulsen, H. 1998], [206, Traulsen, H. 1999]

Table 13.9: Rönnskär Project

Year	Installation cost	Product made and design capacity	Plant sections included
1999	SEK 2 billion (EUR 224 million)	Copper 100 000 t/yr	Extension to quay for raw material unloading; Enclosed conveyors for raw material handling; Mixing plant and conveyors; Outotec flash furnace; Converter aisle with three Peirce-Smith converters with a capacity of 250 tonnes; Ventilation air extraction system and bag filter; Fire refining and anode casting plant - 45 t/h extra capacity; 33 % increase in copper electrorefinery, evaporator to produce copper sulphate; Refurbishment of sulphuric acid plants to handle 280 000 Nm ³ /h; Mercury removal stage; Process instrumentation; Civil engineering costs.
NB: The plant was upgraded in 1999 to allow the production of an additional 100 000 t/yr of copper. The anticipated payback period was 6.5 years.			

Table 13.10: Secondary copper smelters

Year	Installation cost (EUR/t production capacity/yr)	Product made and design capacity	Plant sections included
1990	1300–1500	Anode copper 50 000 t/yr	Material handling/storage, <u>shaft furnace</u> , converter, anode plant
1990	1100–1300	Anode copper 80 000–100 000 t/yr	Material handling/storage, <u>electric furnace</u> , converter, anode plant
1991	1250–1400	Anode copper, 60 000 t/yr	Material handling/storage, <u>TBR furnace</u> , anode plant ⁽¹⁾
⁽¹⁾ The technical concept is different from the process now used at Metallo-Chimique and Elmet. NB: Original costs were in USD and have been converted using EUR 1 = USD 1.06. Source: Boliden [90, Traulsen, H. 1998].			

Table 13.11: Electrolytic copper refineries

Year	Installation cost (EUR/t production capacity/yr)	Product made and design capacity	Plant sections included
1976	470	Cathode copper 380 000 t/yr	Conventional process concept with starter sheets and mechanisation
1987	550–600	Cathode copper 40 000 t/yr	ISASMELT process concept with permanent cathodes
1990	400–450	Cathode copper 180 000 t/yr	ISASMELT process concept with permanent cathodes
1993	450–480	Cathode copper 150 000 t/yr	ISASMELT process concept with permanent cathodes
1994	650	Cathode copper 280 000 t/yr	Retrofit/expansion of an existing refinery based on the Kidd Creek concept with permanent cathodes
1996	400–450	Cathode copper 200 000 t/yr	ISASMELT process concept with permanent cathodes

NB: Original costs were in USD and have been converted using EUR 1 = USD 1.06.
Source: [90, Traulsen, H. 1998]

Table 13.12: Copper wire rod plants

Year	Installation cost (EUR/t production capacity/yr)	Product made and design capacity	Plant sections included
1992	180–200	Copper wire rod 220 000 t/yr	Continuous <u>Southwire</u> type rod line with shaft furnace for melting
1995	280–320	Copper wire rod 80 000 t/yr	Continuous <u>Southwire</u> type rod line with shaft furnace for melting
1995	290–330	Copper wire rod 80 000 t/yr	Continuous <u>Contirod</u> type rod line with shaft furnace for melting

NB: Original costs were in USD and have been converted using EUR 1 = USD 1.06.
Source: [90, Traulsen, H. 1998]

13.3.3 Specific investment costs for primary and secondary aluminium processes

Primary aluminium smelters

The following ranges are given as investment costs for conversions that are identified as possible options for a new plant or for upgrading existing plants [421, EAA, 2014]:

Side-worked prebaked (SWPB) to point feed prebaked (PFPB): EUR 400–1000 per tonne yearly of production capacity.

Centre-worked prebaked to point feed prebaked: EUR 100–200 per tonne of yearly production capacity.

Vertical stud Söderberg (VSS) to point feed prebaked: EUR 2300–3100 per tonne of yearly production capacity.

Conventional VSS to modernised VSS: EUR 270–400 per tonne of yearly production capacity.

New point feed prebaked (greenfield site): EUR 4500–5500 per tonne of yearly production capacity.

The conversion of SWPB or VSS to point feed prebaked can, in most cases, never be achieved to a standard comparable to a completely new PFPB plant.

The operating cost for a primary smelter depends entirely on the factors given above and will, according to reports from various consultants, be in the range of EUR 1200–1600 per tonne, excluding capital costs.

Investment costs for abatement equipment will again depend on site-specific conditions, since this will determine the extent of the additional equipment and work necessary in addition to the actual equipment installation. The following ranges can be given:

Dry scrubbing unit:	EUR 200–300 per tonne produced per year.
SO ₂ wet scrubber with seawater for pot gases:	EUR 100–200 per tonne produced per year.
SO ₂ alkali scrubber for pot gases:	EUR 150–250 per tonne produced per year.

Secondary aluminium melters

Process equipment costs:

- Rotary furnace: EUR 15–60 per tonne produced per year.

Abatement equipment costs:

- Bag filter system: EUR 30–75 per tonne produced per year.
- Ceramic filter system: EUR < 30 per tonne produced per year.

13.3.4 Specific investment costs for lead-zinc processes

Table 13.13 to Table 13.16 give some data for primary and secondary lead smelters, for electrolytic zinc plants as well as lead-zinc shaft furnaces, for a Waelz kiln, a fuming plant and H₂SO₄ plants. Costs are given in USD per tonne of metal produced per year. Again, the exchange rate USD to local currency is very important, as it is time-dependent.

The data presented include:

1. the year for which the cost figures have been evaluated;
2. the volume of delivery;
3. the size of the smelter;
4. the specific investment costs per tonne of metal.

In the case of lead-zinc shaft furnaces, the investment costs are related to zinc production alone as well as to total Zn + Pb production. The costs only show the order of magnitude for such investments.

Table 13.13: Lead processes

Year	Installation cost (EUR/t production capacity/yr)	Product made and design capacity	Plant sections included
1980	660	Pb, 100 000 t/yr	Sinter machine, shaft furnace, H ₂ SO ₄ plant, lead refining
1990	400	Pb, 60 000 t/yr	Secondary, plastics separation, smelting, lead refining
1990	635	Pb, 30 000 t/yr	Secondary, plastics separation, smelting, lead refining (same order of magnitude for CX system)
1997	625	Pb, 100 000 t/yr	QSL plant, H ₂ SO ₄ plant, without lead refining (Kivcet and TBRC plant should show similar investment costs)
1997	330	Pb, 30 000 t/yr	Secondary shaft furnace, lead refining
1997	145	Pb, 100 000 t/yr	Lead refining
2009	1080 ⁽¹⁾	Pb, 65 000 t/yr	Ausmelt plant with installation and abatement and acid plant
⁽¹⁾ Total installation cost was EUR 70 million for 65 000 t/yr Source: [117, Krüger, J. 1999]			

Table 13.14: Zinc processes

Year	Installation cost (EUR/t production capacity/yr)	Product made and design capacity	Plant sections included
1980	1580	Zn, 100 000 t/yr	Roasting, leaching, purification, electrolysis, H ₂ SO ₄ plant, foundry
1996	1530	Zn, 100 000 t/yr	Roasting, leaching, purification, electrolysis, H ₂ SO ₄ plant, foundry
1997	1450	Zn, 100 000 t/yr	Roasting, leaching, purification, electrolysis, H ₂ SO ₄ plant, foundry
2002	533 ⁽¹⁾	Zn, 75 000 t/yr	Roaster, WHB and water treatment, gas cleaning, H ₂ SO ₄ plant, cooling water installation, weak acid treatment
⁽¹⁾ Total installation cost was EUR 40 million for 75 000 t/yr Source: [117, Krüger, J. 1999]			

Table 13.15: Zinc and lead processes

Year	Installation cost (EUR/t production capacity/yr)	Product made and design capacity	Plant sections included
1980	1550	Zn, 100 000 t/yr; Pb, 40 000 t/yr	Sinter-roasting, ISF, H ₂ SO ₄ plant, Zn refining
1996	1380	Zn, 100 000 t/yr; Pb, 40 000 t/yr	Sinter-roasting, ISF, H ₂ SO ₄ plant, Zn refining
1996	2080	Zn, 100 000 t/yr	Sinter-roasting, ISF, H ₂ SO ₄ plant, Zn refining
1997	1790	Zn, 100 000 t/yr; Pb, 40 000 t/yr	Sinter-roasting, ISF, H ₂ SO ₄ plant, Zn refining
1997	2580	Zn, 100 000 t/yr	Sinter-roasting, ISF, H ₂ SO ₄ plant, Zn refining
1994	2800	Zn, 85 000 t/yr; Pb, 35 000 t/yr	Sinter-roasting, ISF, H ₂ SO ₄ plant, Zn refining
Source: [117, Krüger, J. 1999]			

Table 13.16: Zinc residues

Year	Installation cost (EUR/t production capacity/yr)	Product made and design capacity	Plant sections included
1980	480	Waelz oxide, 21 000 t/yr	Waelz kiln, cooler, filter
1997	415	Slag, 20 000 t/yr	Drying, fuming, waste heat boiler, PSA, filter

Source: [117, Krüger, J. 1999]

13.3.5 Cost data for abatement techniques

13.3.5.1 Air emissions abatement in the copper industry

The techniques applied for cleaning the off-gases and ventilation gases from copper operations are focused on the elimination of dust and gaseous matter including SO₂ and SO₃. Examples of widely applied gas cleaning systems/equipment are electrostatic precipitators (ESPs), bag filters, ceramic filters, etc.

The following data are given for a waste heat boiler, hot and wet ESPs, gas cooling and cleaning.

The data for complete sulphuric acid plants are given later.

Table 13.17: Indirect gas cooling - energy recovery

Application: Smelting furnace waste heat boiler	
Design basis:	
Gas temperature:	
Inlet	1300–1350 °C
Outlet	300–400 °C
Gas flow	100 000 Nm ³ /h
Steam production	35 t/h
Total installation cost	EUR 7.0–8.0 million

Table 13.18: Dry ESP

Smelter SO ₂ gas cleaning		
Application	Flash furnace ESP	Flash furnace ESP
Design basis:		
Operating temperature	300–400 °C	300–400 °C
Gas flow	43 000 Nm ³ /h	61 000 Nm ³ /h
Dust inlet	10–20 g/Nm ³	10–15 g/Nm ³
Dust outlet	150–200 mg/Nm ³	200–300 mg/Nm ³
Efficiency	99.9 %	99.8 %
ESP characteristics:	4 fields, 3000 m ² collection area, single unit	3 fields, 4800 m ² collection area, single unit
Total equipment supply cost	EUR 1.0 million ⁽¹⁾	EUR 2.0 million ⁽¹⁾
Electricity consumption	250 kW installed	400 kW installed

⁽¹⁾ Civil work, erection, etc. excluded; for installation costs, approximately 80–100 % will have to be added.

Source: [195, Lurgi, A.G. et al. 1991]

Table 13.19: Bag filter

Application	Shaft furnace, converter & anode furnace	TBRC	Cooler & bag filter
Design basis:			
Operating temperature	~ 100 °C	~ 100 °C	~ 100 °C
Gas flow	750 000 Nm ³ /h	730 000 Nm ³ /h	70 000 Nm ³ /h
Dust outlet	< 10 mg/Nm ³	< 10 mg/Nm ³	< 10 mg/Nm ³
Total installation cost	EUR 20 million ⁽¹⁾	EUR 14 million ⁽²⁾	EUR 2–2.5 million ⁽³⁾
Main consumption:			
Electricity	2.5–3 kWh/1000 Nm ³	2–3 kWh/1000 Nm ³	1.5–4 kWh/1000 Nm ³
Others	1 g/Nm ³ lime ⁽⁴⁾		
⁽¹⁾ Including ductwork and stack. ⁽²⁾ Excluding ductwork and stack. ⁽³⁾ Total installation cost including gas cooler and stack. ⁽⁴⁾ For anode furnace gas stream Source: [90, Traulsen, H. 1998]			

Table 13.20: Wet ESP

SO ₂ gas treatment	
Type	Two wet ESPs in line
Application	Final SO ₂ gas cleaning for further treatment
Design basis:	
Operating temperature	27 °C inlet
Gas flow	88.00 Nm ³ /h
Precipitation efficiency for	
Dust	99 %
Arsenic	99 %
H ₂ SO ₄	99 %
Total equipment supply costs	EUR 2.0 million ⁽¹⁾
Electricity consumption	112 kW
⁽¹⁾ Civil work, erection, etc. excluded; for installation costs, approximately 60–80 % will have to be added. Source: [195, Lurgi, A.G. et al. 1991]	

Table 13.21: Wet ESP

Wet gas cooling and cleaning system for smelter SO ₂ gases		
System	Wet gas cleaning for furnace SO ₂ gas	Wet gas cooling and cleaning section for combined SO ₂ in furnace and converter gases
System equipment	1 radial flow scrubber, 1 fan, 2 in-line wet ESPs with a 2000 m ² total collection area, acid cooler and acid circulation pumps, 1 cooling tower, 900 m ³ /h cooling media circulation	2 radial flow scrubbers, 3 lines with 2 in-line wet ESPs with a 7000 m ² total collection area, acid cooler and acid circulation pumps, 2 cooling towers, 2200 m ³ /h cooling media circulation
Design basis:		
Operating temperature	390 °C inlet, 35 °C outlet	370 °C inlet, 27 °C outlet
Gas flow	96 000 Nm ³ /h	250 000 Nm ³ /h
Precipitation efficiency for:		
Dust	96–97 %	96–97 %
Arsenic	99.0 %	99.0 %
Mist	> 99.5 %	> 99.5 %
Equipment supply costs	EUR 7.5–8 million ⁽¹⁾	EUR 16–17 million ⁽²⁾
Electricity consumption	828 kW	1250 kW
⁽¹⁾ Civil work, erection, etc. excluded; for installation costs, approximately 60–80 % will have to be added. ⁽²⁾ Civil work, erection, etc. excluded; for installation costs, approximately 70–100 % will have to be added. Source: [195, Lurgi, A.G. et al. 1991]		

The following cost data are given for abatement systems used in secondary copper processes and were provided by Austria. The costs are given in Austrian schillings (ATS) and euros (EUR); site-specific investment, operating and disposal costs are given [157, Winter, B. et al. 1999]

Table 13.22: Afterburner, reactor and bag filter

Regenerative afterburner installation with reactor and fabric filter treating off-gases from a shaft furnace		
Input data: Volume of exhaust gas of 20 000 Nm ³ /h	Quantity of metal produced: 18 000 t/yr black copper. Operating hours 6300 h/yr	
Output data: < 0.1 ng I-TEQ/Nm ³ PCDD/F		
Description: Regenerative afterburner installed after a fabric filter treating 20 000 Nm ³ /h of dedusted gas with a reduction of 98 % for PCDD/F		Costs ATS/t metal (EUR/t metal)
Input factors for annual expenditure:		
Investment costs (million ATS)	12 +/-20 %	
Number of years	15	
Interest rate (%)	6	
Annual repayment including interest (million ATS/yr)	1.24	
Proportional investment costs including interest		68.64 (4.99)
Maintenance + wear and tear (% of investment costs = ATS 0.24 million/yr)	2	13.33 (0.97)
Proportional costs:		
Support fuel (MJ/t)	1342	80.52
Electrical energy consumption (kWh/t) at ATS 0.9/kWh	13.5	12.15
Total costs		~ 175 (12.72)
<i>Source:</i> Austrian cost data in [157, Winter, B. et al. 1999]		

Table 13.23: Afterburner

Afterburner placed between a shaft furnace and waste heat boiler		
Input data: Volume of exhaust gas of 20 000 Nm ³ /h	Quantity of metal produced: 18 000 t/yr black copper. Operating hours 6300 h/yr	
Description: 98 % removal of PCDD/F		Costs ATS/t metal (EUR/t metal)
Input factors for annual expenditure:		
Investment costs (million ATS)		
Number of years	8 +/-20 %	
Interest rate (%)	15	
Annual repayment including interest (million ATS/yr)	6	
Proportional investment costs including interest	0.82	45.76 (3.33)
Maintenance + wear and tear (% of investment costs)	2	8.89 (0.65)
Proportional costs:		
Support fuel (MJ/t)	1304	78.24
Electrical energy consumption (kWh/t)	16.0	5.4
Total costs		~ 138 (10.03)
<i>Source: Austrian cost data in [157, Winter, B. et al. 1999]</i>		

Table 13.24: Wet desulphurisation

Wet desulphurisation process to remove sulphur dioxide from scrap converter off-gases		
Input data: Volume of exhaust gas of 35 000 Nm ³ /h. Average input SO ₂ ~ 2300 mg/Nm ³ , peak 4000 mg/Nm ³	Quantity of metal produced: 12 000 t/yr raw copper. Operating hours 1200 h/yr	
Output data: Yearly average SO ₂ < 50 mg/Nm ³ , peak < 200 mg/Nm ³		
Description		Costs ATS/t metal (EUR/t metal)
Input factors for annual expenditure:		
Investment costs (million ATS)	25	
Number of years	15	
Interest rate (%)	6	
Annual repayment including interest (million ATS/yr)	2.54	
Proportional investment costs including interest		214.51 (15.59)
Maintenance + wear and tear (% of investment costs)	2	41.67 (3.03)
Proportional costs:		
Cost of CaO (kg/t Cu) at ATS 1/kg	6.74	6.74
Disposal cost of gypsum (kg/t Cu) at ATS 0.2/kg	22.99	4.6
Electrical energy consumption (kWh/t) at ATS 0.9/kWh	16.39	14.75
Total costs		~ 282 (20.49)
<i>Source: Austrian cost data in [157, Winter, B. et al. 1999]</i>		

Table 13.25: Semi-dry scrubber

Semi-dry desulphurisation process to reduce sulphur dioxide from an anode furnace		
Input data: Volume of exhaust gas of 80 000 Nm ³ /h. Pressure drop 20 mbar. SO ₂ ~ 500 mg/Nm ³	Quantity of metal produced: 60 000 t/yr anode copper. Operating hours 7000 h/yr	
Output data: SO ₂ ~ 50 mg/Nm ³ , 95 % reduction of PCDD/F		
Description		Costs ATS/t metal (EUR/t metal)
Input factors for annual expenditure:		
Investment costs (million ATS)	30 +/- 20 %	
Number of years	15	
Interest rate (%)	6	
Annual repayment including interest (million ATS/yr)	3.09	51.48 (3.74)
Proportional investment costs including interest		
Maintenance + wear and tear (% of investment costs)	3	15 (1.09)
Proportional costs:		
CaO (kg/t Cu)	7.35	7.35
Carbon (kg/t Cu)	1.87	6.53
Combustion air	23.33	3.97
Disposal (kg/t Cu)	13.42	26.83
Electrical energy consumption (kWh/t)	14.08	12.67
Total costs		~ 124 (9.01)
<i>Source: Austrian cost data in [157, Winter, B. et al. 1999]</i>		

Table 13.26: Activated carbon filter

Activated carbon filter for black copper production		
Input data: Volume of exhaust gas 20 000 Nm ³ /h. Pressure drop 25 mbar	Quantity of metal produced: 18 000 t/yr black copper. Operating hours 6300 h/yr	
Output data: PCDD/F < 0.1 ng I-TEQ/Nm ³		
Description		Costs ATS/t metal (EUR/t metal)
Input factors for annual expenditure:		
Investment costs (million ATS)	12	
Number of years	15	
Interest rate (%)	6	
Annual repayment including interest (million ATS/yr)	1.24	68.64 (4.99)
Proportional investment costs including interest		
Maintenance + wear and tear (% of investment costs)	2	13.33 (0.97)
Proportional costs:		
Consumption and disposal of activated carbon (kg/t Cu) at ATS 6.5 /kg	1.4	9.1
Electrical energy consumption (kWh/t) at ATS 0.9/kWh	17.51	15.76
Total costs		~ 107 (7.78)
<i>Source: Austrian cost data in [157, Winter, B. et al. 1999]</i>		

Table 13.27: SCR

Selective catalytic reduction to reduce oxides of nitrogen		
Input data: Volume of exhaust gas of 20 000 Nm ³ /h	Quantity of metal produced: 18 000 t/yr black copper. Operating hours 6300 h/yr	
Output data: NO _x < 100 mg/Nm ³ , 98 % reduction of PCDD/F		
Description		Costs ATS/t metal (EUR/t metal)
Input factors for annual expenditure:		
Investment costs (million ATS)	10	
Number of years	15	
Interest rate (%)	6	
Annual repayment including interest (million ATS/yr)	1.03	
Proportional investment costs including interest		57.2 (4.16)
Maintenance + wear and tear (% of investment costs)	2	11.11 (0.81)
Proportional costs:		
Cost of ammonia (kg/t Cu) at ATS 1.8/kg	2.07	3.73
Replacement catalyst (m ³ /yr) at ATS 200 000 /m ³	0.5	5.56
Energy for reheat (MJ/t) at ATS 60/GJ	284	17.01
Electrical energy consumption (kWh/t) at ATS 0.9/kWh	19.03	17.13
Total costs		~ 112 (8.14)
<i>Source:</i> Austrian cost data in [157, Winter, B. et al. 1999]		

The following data were supplied in 2007 by Germany for the review of the NFM BREF.

The capital cost of emission control measures and equipment varies with the type of plant. While in existing plants, retrofit costs can be very high, integrated pollution control measures in new plants may be more cost-effective. Factors governing the capital cost of a fabric filter system include:

- the off-gas volume to cleaned;
- the off-gas characteristics (dust and moisture content, temperature, presence of aggressive constituents);
- the need for additive dosing or flue-dust recirculation (additional piping, silos, conveying systems);
- available floor area for construction; type of construction (arrangement options, shallow or pile foundation, overall height, filter area, number of compartments, duct routing, etc.);
- the necessary stack height or need for stack lining (depending on off-gas composition);
- the necessary measuring equipment (platform, continuous monitoring equipment, access);
- extended scope of supplies (off-gas cooler, compressors etc.).

Off-gases with low dust loads (e.g. secondary hood off-gases with fine dust loads $< 50 \text{ mg/Nm}^3$) normally require the addition of an additive (e.g. lime) to improve the dust collection efficiency. This not only drastically increases the raw gas dust load, but also the volume of collected dust that has to be disposed of. For moist and/or aggressive off-gases, the filter may have to be heated or provided with a corrosion protection coating.

At the time of publication of the VDI guidelines (2007), the capital cost of a bag filter designed for an off-gas flow rate of approximately $100\,000 \text{ m}^3/\text{h}$, including fan and filter media, was of the order of approximately EUR 650 000 (secondary hood off-gas with low dust load) or approximately EUR 950 000 (process off-gas with elevated dust load). The total cost of a filter system including steel and concrete structures, ducting, stack and other equipment (see above) may amount to three or four times the capital cost of the filter [219, VDI 2007].

Electricity consumption is the largest single contributor to the operating costs. Depending on the filter area, filter resistance, dust composition and concentration, the specific power consumption of a fabric filter ranges between 2 kWh and 3 kWh per 1000 Nm^3 of off-gas. If, due to the specific additive used, the dust collected in the filter system cannot be further processed for metal recovery and has to be landfilled, the additional cost will be substantial.

13.3.5.2 Air emissions abatement - aluminium industry

The following cost data are given for abatement systems used in secondary aluminium processes and were provided by Austria. The costs are given in Austrian schillings (ATS) and euros (EUR); site-specific investment, operating and disposal costs are given [142, Boin, U. et al. 1998].

Table 13.28: Dry scrubber and bag filter

Lime injection with a bag filter		
Input data: Volume of exhaust gas of 40 000 Nm ³ /h that contains ~ 600 mg dust/Nm ³ , 500 mg SO ₂ /Nm ³ , 300 mg HCl/Nm ³ and 50 mg HF/Nm ³	Quantity of metal produced: 40 000 t/yr Al. Operating hours 5500 h/yr	
Output data: < 5 mg dust/Nm ³ , < 300 mg SO ₂ /Nm ³ , < 30 mg HCl/Nm ³ and < 5 mg HF/Nm ³		
Description		Costs ATS/t metal (EUR/t metal)
Input factors for annual expenditure:		
Investment costs (million ATS)	15	
Number of years	15	
Interest rate (%)	6	
Annual repayment including interest (million ATS/yr)	1.54	
Proportional investment costs including interest		38.61 (2.81)
Maintenance + wear and tear (% of investment costs)	3	11.25 (0.82)
Proportional costs:		
Consumption of CaO (kg/t Al)	22	22
Electrical energy consumption (kWh/h)	102	14.03
Technology costs		86 (6.25)
Disposal of filter dust (kg/t Al)	35–60	70–240 (5.09–17.44)
Total costs		~ 156–326 (11.34–23.69)
NB: The range of the total costs is influenced by the variability of the disposal cost for filter dust. This factor varies a lot across the EU. Source: [142, Boin, U. et al. 1998]		

Table 13.29: Semi-dry scrubber and bag filter

Semi-dry lime injection with a bag filter and absorbent recirculation		
Input data: Volume of exhaust gas of 40 000 Nm ³ /h that contains ~ 600 mg dust/Nm ³ , 1000 mg SO ₂ /Nm ³ , 300 mg HCl/Nm ³ and 50 mg HF/Nm ³	Quantity of metal produced: 40 000 t/yr Al. Operating hours 5500 h/yr	
Output data: < 5 mg dust/Nm ³ , < 200 mg SO ₂ /Nm ³ , < 10 mg HCl/Nm ³ , < 1 mg HF/Nm ³ and < 0.1 ng PCDD/F/Nm ³		
Description		Costs ATS/t metal (EUR/t metal)
Input factors for annual expenditure:		
Investment costs (million ATS)	20	
Number of years	15	
Interest rate (%)	6	
Annual repayment including interest (million ATS/yr)	2.06	51.48 (3.74)
Proportional investment costs including interest		15 (1.09)
Maintenance + wear and tear (% of investment costs)	3	
Proportional costs:		
Consumption of CaO (kg/t Al)	22	22
Consumption of activated carbon (kg/t Al)	1	3.5
Electrical energy consumption (kWh/h)	110	15.13
Technology costs		107.11 (7.78)
Disposal of filter dust (kg/t Al)	35–60	70–240 (5.09–17.44)
Total costs		~ 180–350 (13.08–25.44)
NB: The range of the total costs is influenced by the variability of the disposal cost for filter dust. This factor varies a lot across the EU. Source: [142, Boin, U. et al. 1998]		

Table 13.30: Semi-dry scrubber and bag filter

Semi-dry sodium bicarbonate injection with bag filter and absorbent recirculation for sulphur-dioxide-free gas		
Input data: Volume of exhaust gas of 40 000 Nm ³ /h that contains ~ 600 mg/Nm ³ dust	Quantity of metal produced: 40 000 t/yr Al. Operating hours 5500 h/yr	
Output data: < 5 mg dust/Nm ³ , < 0.1 ng PCDD/F/Nm ³		
Description		Costs ATS/t metal (EUR/t metal)
Input factors for annual expenditure:		
Investment costs (million ATS)	14	
Number of years	15	
Interest rate (%)	6	
Annual repayment including interest (million ATS/yr)	1.44	36.04 (2.62)
Proportional investment costs including interest		10.5 (0.76)
Maintenance + wear and tear (% of investment costs)	3	
Proportional costs:		
Consumption of NaHCO ₃ (kg/t Al) at ATS 3/kg	12	36
Electrical energy consumption (kWh/h) at ATS 1/kWh	110	15.13
Technology costs		97.67 (7.1)
Disposal of filter dust (kg/t Al)	15–30	15–30 (1.09–2.18)
Total costs		~ 110–130 (7.99–9.45)
NB: The range of the total costs is influenced by the variability of the disposal cost for filter dust. This factor varies a lot across the EU. In this particular example, the filter dust is based on sodium bicarbonate and sodium chloride and is suitable for processing in a salt recovery process. Source: [142, Boin, U. et al. 1998]		

Table 13.31: Wet scrubber and ESP

Wet scrubber with an electrostatic precipitator		
Input data: Volume of exhaust gas of 40 000 Nm ³ /h that contains ~ 600 mg dust/Nm ³ , 1000 mg SO ₂ /Nm ³ , 300 mg HCl/Nm ³ and 50 mg HF/Nm ³	Volume of metal produced: 40 000 t/yr Al. Operating hours 5500 h/yr	
Output data: ~ 5–15 mg dust/Nm ³ , < 50 mg SO ₂ /Nm ³ , < 5 mg HCl/Nm ³ and < 1 mg HF/Nm ³		
Description		Costs ATS/t metal (EUR/t metal)
Input factors for annual expenditure:		
Investment costs (million ATS)	17	
Number of years	15	
Interest rate (%)	6	
Annual repayment including interest (million ATS/yr)	1.75	43.76 (3.18)
Proportional investment costs including interest		8.5 (0.62)
Maintenance + wear and tear (% of investment costs)	2	
Proportional costs:		
Water consumption (m ³ /t Al) and waste water disposal	0.3	1.5–9
Consumption of CaO (kg/t Al)	11	11
Electrical energy consumption (kWh/h)	90	12.38
Technology costs		77.14–84.64 (5.61–6.15)
Disposal of filter dust (kg/t Al)	10–35	20–140 (1.45–10.17)
Disposal of neutralisation sludge (kg/t Al)	15	22.5–45 (1.64–3.28)
Total costs		~ 120–270 (8.72–19.62)
NB: The range of the total costs is influenced by the variability of the disposal cost for filter dust. This factor varies a lot across the EU. Source: [142, Boin, U. et al. 1998]		

Table 13.32: Semi-dry scrubber, activated carbon injection and bag filter

Combination of semi-dry lime and activated carbon injection with a bag filter		
Input data: Volume of exhaust gas of 40 000 Nm ³ /h that contains 600 mg dust/Nm ³ , 1000 SO ₂ /Nm ³ , 300 mg HCl/Nm ³ and 50 mg HF/Nm ³	Quantity of metal produced: 40 000 t/yr Al. Operating hours 5500 h/yr	
Output data: < 5 mg dust/Nm ³ , < 50 mg SO ₂ /Nm ³ , < 5 mg HCl/Nm ³ , < 1 mg HF/Nm ³ and the reduction of PCDD/F to under 0.1 ng I-TEQ/Nm ³		
Description		Costs ATS/t metal (EUR/t metal)
Input factors for annual expenditure:		
Investment costs (million ATS)	22	
Number of years	15	
Interest rate (%)	6	
Annual repayment including interest (million ATS/yr)	2.27	
Proportional investment costs including interest		56.63 (4.16)
Maintenance + wear and tear (% of investment costs)	3	16.5 (1.2)
Proportional costs:		
Consumption of CaO (kg/t Al)	11	11
Consumption of activated carbon (kg/t Al)	1	3.5
Electrical energy consumption (kWh/h)	160	22
Technology costs		109.63 (7.97)
Disposal of filter dust (kg/t Al)	25–50	50–200 (3.63–14.53)
Total costs		~ 160–310 (11.63–22.53)
NB: The range of the total costs is influenced by the variability of the disposal cost for filter dust. This factor varies a lot across the EU. Source: [142, Boin, U. et al. 1998]		

13.3.5.2.1 Costs associated with deSO_x

Cost data have been compiled for a variety of process variations and abatement systems. Some costs are included where available with the examples given earlier in this chapter. The cost data are very site-specific and depend on a number of factors but the ranges given may enable some comparisons to be made.

The Netherlands have made a comparison between the cost-effectiveness of deSO_x abatement techniques of two smelters. The cost-effectiveness method that is used is the method described in Section 4.13 of the Netherlands Emission Guidelines for Air (NeR) and in the BREF cross-media effects and economics as shown in Table 13.33 [241, Infomil 2008]

Table 13.33: Cost-effectiveness according to NeR methodology

Costs, effects and cost-effectiveness	Plant A	Plant B
Costs:		
Total investments (million EUR)	32.4	23.5
Capital costs (thousand EUR)	4975	3839
Fixed operating costs (thousand EUR)	1002	680
Variable operating costs (thousand EUR)	7571	1624
Total gross (or net) yearly costs (thousand EUR)	13548 (A)	6143
Effects:		
Yearly unabated load (thousand tonnes)	2.67	2.0
Yearly remaining emission (thousand tonnes)	0.45	0.3
Avoided SO ₂ (thousand tonnes)	2.2 (B)	1.7
Cost-effectiveness (EUR per kg):		
- with gas reheating (A/(B1000)) (to prevent occurrence of blue mist)	6.2	
- without gas reheating	3.7	3.6
<i>Source: Data from [303, ENVIRONNEMENT CANADA 2008.]</i>		

Other cost data are provided below so that costs for processes and abatement systems over the whole of the non-ferrous metals industry can be compared:

- Wet scrubber with seawater: EUR 1600–2800/t SO₂ (annual basis) [421, EAA, 2014];
- NaOH or soda ash scrubber: EUR 1367–3000/t SO₂ (annual basis); one reference plant in Norway, four in the US;
- double alkali scrubber: EUR 1183–1270/t SO₂ (annual basis);
- calcium (carbonate): EUR 3300–3700/t SO₂ (annual basis) [421, EAA, 2014];
- calcium (lime): EUR 1954/t SO₂ (annual basis).

13.3.5.3 Sulphuric acid plants

Table 13.34: Copper smelter sulphuric acid plants

Gas cooling and cleaning section, double contact/double absorption sulphuric acid plant. Applied to copper smelter		
Gas cooling and cleaning system	Wet gas cooling and cleaning section for combined SO ₂ gas of furnace and converter gases	Wet gas cooling and cleaning section for combined SO ₂ gas of furnace and converter gases
Equipment supplied	2 radial flow scrubbers, 3 lines with 2 in-line wet ESPs, acid cooler and acid circulation pumps, 2 cooling towers, 2200 m ³ /h cooling media circulation	1 reverse jet scrubber, 1 cooling tower, 3-lines first-stage wet ESPs, 2-lines second-stage wet ESPs, acid cooler, SO ₂ stripper, acid circulation pumps, 2 cooling towers, 6–24 m ³ /h weak acid effluent
Contact acid plant	Double catalysis sulphuric acid plant	Double catalysis sulphuric acid plant
Equipment supplied	Single strand, 4-pass converter with inter-pass absorption after the second pass	Single strand, 5-pass converter with inter-pass absorption after the third pass
Design basis gas cleaning: Operating temperature Gas flow Precipitation efficiency for dust	370 °C inlet, 27 °C outlet 91 000–123 000 Nm ³ /h 96.7 %	370 °C inlet, 27 °C outlet 45 000–115 000 Nm ³ /h 96.7 %
Design basis contact plant: Gas flow SO ₂ Conversion SO ₂ /SO ₃ H ₂ SO ₄ production	91 000–123 000 Nm ³ /h 10–15.1 % (avg. 13 %) > 99.5 % 1700 t/d	45 000–115 000 Nm ³ /h 6–11.3 % > 99.5 % 1350 t/d
Installation costs	EUR 44–45 million	EUR 51–52 million
Main consumption:	(¹)	(¹)
Electricity	75–80 kWh/t acid	55–60 kWh/t acid
Fuel oil		2–3 kg/t acid
Natural gas	3–4 Nm ³ /t acid	
Catalyst	0.02–0.04 l/t acid	0.02–0.04 l/t acid
Labour	0.1 h/t acid (¹)	0.1 h/t acid (¹)
(¹) t acid = tonnes of nominal design of sulphuric acid production plant. Source: [90, Traulsen, H. 1998.]		

Table 13.35: Sulphuric acid plants

Sulphuric acid plants. Applied to lead/zinc smelters			
Year	Components	Cost (EUR per t/yr of acid)	Acid production
1995	Double contact/double absorption plant	40	800 000 t/yr acid
1996	Double contact/double absorption plant + Hg removal	155 120	100 000 t/yr acid 200 000 t acid
1997	Double contact/double absorption plant + Hg removal	130 100	100 000 t/yr acid 200 000 t acid
2009	Addition of 5 th bed with blower capacity increase	Total cost EUR 8 million	Updated costs provided by Lurgi (Outotec)
2009	Change of catalyst in 4 th bed to incorporate caesium-promoted catalyst	Total cost EUR 700 000	Updated costs provided by Lurgi (Outotec)
2009	H ₂ O ₂ scrubber for 100 000 t/yr acid plant	Total cost EUR 25 million	Updated costs provided by Lurgi (Outotec)

Source: [117, Krüger, J. 1999]

13.3.5.4 Effluent treatment systems

Table 13.36: Weak acid neutralisation

Neutralisation of weak acid from a sulphuric acid plant and other acidic process water	
System equipment	Thickeners, tanks, pumps, filter press
Application	Weak acid resulting from a SO ₂ gas flow of 200 000 Nm ³ /h
Design basis:	
Flow	32 m ³ /h weak acid
Installation cost	EUR 2.5 million ⁽¹⁾
Main consumption:	
Electricity	200 kW
Lime milk (10 %)	15 m ³ /h
H ₂ SO ₄ (10 %)	0.8 m ³ /h
FeSO ₄ ·7 H ₂ O	80 kg/h
⁽¹⁾ Civil work, erection, etc. excluded; for installation costs, approximately 90–110 % will have to be added.	
Source: [195, Lurgi, A.G. et al. 1991]	

The cost of a waste water treatment plant of 350–400 m³/h for a zinc/lead plant producing 140 000 t/yr metal with lime and FeCl₃ treatment, settlement tanks and sludge filter press was EUR 3 million (in 2005). Local treatment for weak acid is undertaken at an additional cost.

14 GLOSSARY

This glossary is meant to facilitate the understanding of the information contained in this document. The definitions of terms in this glossary are not legal definitions (even if some of them may coincide with definitions given in European legislation), they are meant to help the reader understand some key terms in the context of their use in the specific sector covered by this document.

This glossary is divided into the following sections:

- I. ISO country codes
- II. Monetary units
- III. Unit prefixes, number separators and notations
- IV. Units and measures
- V. Chemical elements
- VI. Chemical formulae commonly used in this document
- VII. Acronyms and definitions

I. ISO country codes

ISO code	Country
<i>Member States (*)</i>	
AT	Austria
BE	Belgium
BG	Bulgaria
CZ	Czech Republic
DE	Germany
ES	Spain
FI	Finland
FR	France
IT	Italy
NL	Netherlands
PL	Poland
PT	Portugal
SE	Sweden
UK	United Kingdom
<i>Non-member countries</i>	
CH	Switzerland
NO	Norway
US	United States
(*) The protocol order of the Member States is based on the alphabetical order of their geographical names in the original language(s).	

II. Monetary units

Code ⁽¹⁾	Country/territory	Currency
<i>Member State currencies</i>		
EUR	Euro area ⁽²⁾	euro (pl. euros)
ATS	Austria	Austrian schilling
DEM	Germany	German mark
GBP	United Kingdom	pound sterling (inv.)
PLN	Poland	zloty (pl. zlotys)
SEK	Sweden	krona (pl. kronor)
<i>Other currencies</i>		
USD	United States	US dollar
⁽¹⁾ ISO 4217 codes. ⁽²⁾ Includes Austria, Belgium, Cyprus, Estonia, Finland, France, Germany, Greece, Ireland, Italy, Latvia, Lithuania, Luxembourg, Malta, the Netherlands, Portugal, Slovakia, Slovenia and Spain.		

III. Unit prefixes, number separators and notations

Numbers in this document are written using the '.' character as the decimal separator and the space as the separator for thousands.

The symbol ~ (around; about) is the notation used to indicate approximation.

The symbol Δ (delta) is the notation used to indicate a difference.

The following table contains the frequently used prefixes:

Symbol	Prefix	10 ⁿ	Word	Decimal Number
T	tera	10 ¹²	Trillion	1 000 000 000 000
G	giga	10 ⁹	Billion	1 000 000 000
M	mega	10 ⁶	Million	1 000 000
k	kilo	10 ³	Thousand	1 000
h	hecto	10 ²	Hundred	100
da	deca	10 ¹	Ten	10
-----	-----	1	One	1
d	deci	10 ⁻¹	Tenth	0.1
c	centi	10 ⁻²	Hundredth	0.01
m	milli	10 ⁻³	Thousandth	0.001
μ	micro	10 ⁻⁶	Millionth	0.000 001
n	nano	10 ⁻⁹	Billionth	0.000 000 001

IV. Units and measures

Unit symbol	Unit name	Measure name (measure symbol)	Conversion and comment
bar	bar	Pressure (P)	1.013 bar = 100 kPa = 1 atm
°C	degree Celsius	Temperature (T) temperature difference (ΔT)	
d	day	Time	
g	gram	Weight	
h	hour	Time	
J	joule	Energy	
K	Kelvin	Temperature (T) temperature difference (ΔT)	0 °C = 273.15 K
kg	kilogram	Weight	
kJ	kilojoule	Energy	
kPa	kilopascal	Pressure	
kWh	kilowatt-hour	Energy	1 kWh = 3 600 kJ
l	litre	Volume	
lb	pound	Weight	
m	metre	Length	
m ²	square metre	Area	
m ³	cubic metre	Volume	
mg	milligram	Weight	1 mg = 10 ⁻³ g
mm	millimetre		1 mm = 10 ⁻³ m
min	minute		
MW _e	megawatts electric (energy)	Electric energy	
MW _{th}	megawatts thermal (energy)	Thermal energy Heat	
Nm ³	normal cubic metre	Volume	at 101.325 kPa, 273.15 K
Pa	pascal		1 Pa = 1 N/m ²
ppb	parts per billion	Composition of mixtures	1 ppb = 10 ⁻⁹
ppm	parts per million	Composition of mixtures	1 ppm = 10 ⁻⁶
ppmv	parts per million by volume	Composition of mixtures	
rpm	revolutions per minute	Rotational speed, frequency	
t	metric tonne	Weight	1 t = 1 000 kg or 10 ⁶ g
t/d	tonnes per day	Mass flow Materials consumption	
t/yr	tonnes per year	Mass flow Materials consumption	
vol-%	percentage by volume	Composition of mixtures	
wt-%	percentage by weight	Composition of mixtures	
W	watt	Power	1 W = 1 J/s
yr	year	Time	
µm	micrometre	Length	1 µm = 10 ⁻⁶ m

V. Chemical elements

Symbol	Name	Symbol	Name
Ag	Silver	Mg	Magnesium
Al	Aluminium	Mn	Manganese
As	Arsenic	Mo	Molybdenum
Au	Gold	N	Nitrogen
B	Boron	Na	Sodium
Ba	Barium	Nb	Niobium
Be	Beryllium	Ni	Nickel
Bi	Bismuth	O	Oxygen
C	Carbon	Os	Osmium
Ca	Calcium	P	Phosphorus
Cd	Cadmium	Pb	Lead
Cl	Chlorine	Pd	Palladium
Co	Cobalt	Pt	Platinum
Cr	Chromium	Re	Rhenium
Cs	Caesium	Rh	Rhodium
Cu	Copper	Ru	Ruthenium
F	Fluorine	S	Sulphur
Fe	Iron	Sb	Antimony
Ga	Gallium	Se	Selenium
Ge	Germanium	Si	Silicon
H	Hydrogen	Sn	Tin
He	Helium	Ta	Tantalum
Hg	Mercury	Te	Tellurium
I	Iodine	Ti	Titanium
In	Indium	Tl	Thallium
Ir	Iridium	V	Vanadium
K	Potassium	W	Tungsten
Li	Lithium	Zn	Zinc

VI. Chemical formulae commonly used in this document

Chemical formula	Name (explanation)
Al ₂ O ₃	Aluminium oxide
CaO	Calcium oxide, lime
D2EHPA	Di(2-ethylhexyl) phosphoric acid
FeO	Iron oxide
H ₂ O ₂	Hydrogen peroxide
H ₂ S	Hydrogen sulphide
H ₂ SO ₄	Sulphuric acid
HCl	Hydrochloric acid
HF	Hydrogen fluoride
HNO ₃	Nitric acid
K ₂ O	Potassium oxide
MgO	Magnesium oxide, Magnesia
MnO	Manganese oxide
NaOH	Sodium hydroxide. Also called caustic soda
NO ₂	Nitrogen dioxide
NO _x	The sum of nitrogen oxide (NO) and nitrogen dioxide (NO ₂) expressed as NO ₂
PbO	Lead oxide
SiO ₂	Silica, silicon oxide
SO ₂	Sulphur dioxide
SO ₃	Sulphur trioxide
SO _x	Sulphur oxides - SO ₂ and SO ₃
ZnO	Zinc oxide

VII. Acronyms and definitions

Terms used	Definition
Accuracy	Associated with measured values. It is an assessment of how close a measurement is to the accepted or true value. Chemical preparations of known purity and/or concentration are used to assess accuracy. These preparations, known as 'standards', are analysed using the same method by which the samples are measured. Accuracy should never be confused with precision: precision measures how closely the analytical results can be duplicated.
Achieved environmental benefits	Main environmental impact(s) to be addressed by the technique (process or abatement), including emission values achieved and efficiency performance. Environmental benefits of the technique in comparison with others.
Acid	Proton donor - a substance that, more or less readily, gives off hydrogen ions in a water solution.
Acid generation	Production of acidity irrespective of its effect on the adjacent pore water or whether the material is net acid producing or neutralising.
Acidification	Adding acid to a substance to achieve acidic properties.
Acidity	Measure of the capacity of a solution to neutralise a strong base.
Acute toxicity	An adverse effect that results from a single dose or single exposure of a chemical; any poisonous effect produced within a short period of time, usually less than 96 hours. This term is normally used to describe effects in experimental animals. Acute toxicity is measured by determining the LD ₅₀ value.
Acute pollution	Pollution arising from infrequent events, unplanned events or accidents (see also: chronic pollution).
Adsorption	A surface process. The accumulation of molecules of a gas or liquid to form a thin film on the surface of a solid (surface assimilation).
Advantages	See: Benefits.
AEL	Associated emission level.
Afterburner	A specifically designed additional combustion unit with a burner system (not necessarily used all of the time) that provides time, temperature and turbulence with sufficient oxygen to oxidise organic compounds to carbon dioxide. Units can be designed to use the energy content of the raw gas to provide most of the heat input required and are more energy-efficient.
Agglomerate	A network of aggregates loosely connected at discrete points.
Aggregate	A collection of primary particles that have fused to form a face-to-face sintered structure.
Air classifier or ACCU	Machine equipment to separate dust (< 0.05 mm) and fine particles from the dry input material (< 10 mm) or equipment to remove fine and coarse fractions from an airstream.
Alkali	Proton acceptor - a substance that, more or less readily, takes up hydrogen ions in a water solution.
Alkalinity	Measure of the capacity of a solution to neutralise a strong acid.
Alloy	A metal that is a combination, either in solution or compound, of two or more elements, at least one of which is a metal, and where the resulting material has metallic properties.
Analysis	Characterisation of the nature of a sample. Analysis versus assessment: a formal, usually quantitative determination of the effects of an action (as in risk analysis and impact analysis).
Angle of repose	The maximum slope at which a heap of any loose or fragmented solid material will stand without sliding or coming to rest when poured or dumped in a pile or on a slope.
Anion	A negatively charged ion - an ion that is attracted to the anode in electrochemical reactions.
Annual capital cost	An equal, or uniform, payment made each year over the useful life of the proposed technique. The sum of all the payments has the same 'present value' as the initial investment expenditure. The annual capital cost of an asset reflects the opportunity cost to the investor of owning the asset.

Terms used	Definition
Annealing	A heat treatment process that softens the alloy by slowly cooling the metal through its critical temperature range.
Anode	A positive electrode.
Anodising	Anodic oxidation - an electrolytic process in which the surface layer of a metal, such as aluminium, magnesium or zinc is converted to a coating, usually an oxide, having protective, decorative or functional properties.
Applicability	Consideration of the factors involved in applying and retrofitting the technique, e.g. space availability, process specificities.
Approval (of a product, process or service)	Permission for a product, process or service to be marketed or used for stated purposes or under stated conditions.
Approval (of a testing laboratory)	Authorisation given by the competent authority to a testing laboratory to perform regulatory measurements, controls or inspection in a specified field.
AOD converter	A converter using argon oxygen decarburisation.
Assessment	Examination of the level of adequacy of a set of observations and a commensurate set of criteria sufficient for fixed objectives in order to make a decision. Also, the combination of analysis with policy-related activities such as identification of issues and comparison of risks and benefits (such as risk assessment and impact assessment).
Assessment method of emissions	Set of relations between measured data, physical properties, meteorological data, and design data related to equipment or process parameters, and intended to calculate or to assess an emission or an emission factor.
Associated emissions to air	In this document, these are given as daily averages based on continuous monitoring with standard conditions of 273 K, 101.3 kPa, measured oxygen content and dry gas without dilution of the gases with air. In cases where continuous monitoring is not practicable, these are given as the average over the sampling period.
Associated emissions to water	These are based on a qualified random sample or a 24-hour composite sample.
Automatic measuring system	System for measuring the material under investigation, returning an output signal proportional to the physical unit of the parameter to be measured and capable of producing measurement results without human intervention.
BaP	Benzo[<i>a</i>]pyrene (used as an indicator of PAH content).
BAT	Best Available Technique(s), as defined in Article 3(10) of the IED.
BAT-AEL	Best Available Techniques - associated emission level, as defined in Article 3(13) of the IED.
Bath	A solution of chemicals for a specific surface treatment activity, e.g. pickling bath. This also refers to the relevant vat or workstation in a process sequence.
BBOC	Bottom-blown oxygen cupel.
Benefits	Used in this document synonymously with 'advantages' to mean the positive environmental effects considered to be due to the implementation of a technique or other environmental measure.
BF	Blast furnace, a vertical furnace using tuyères to blast heated or cold air into the furnace burden to smelt the contents. (Also known as a hearth shaft furnace, a water jacket furnace and a lead shaft furnace).
Bioavailability	Property of a substance which makes it accessible and potentially able to affect an organism's health. Depends on site-specific conditions.
Biodiversity	The number and variety of different organisms in the ecological complexes in which they naturally occur. Organisms are organised at many levels, ranging from complete ecosystems to the biochemical structures that are the molecular basis of heredity. Thus, the term encompasses different ecosystems, species and genes that must be present for a healthy environment. A large number of species must characterise the food chain, representing multiple predator-prey relationships.
Bioleaching	Process in which minerals are dissolved with the aid of bacteria.

Terms used	Definition
BOD	Biochemical oxygen demand - the quantity of dissolved oxygen required by microorganisms in order to decompose organic matter. The unit of measurement is mg O ₂ /l. In Europe, BOD is usually measured after three (BOD ₃), five (BOD ₅) or seven (BOD ₇) days.
Breathing	Gaseous emission due to ambient temperature change, usually daytime heating of contents of storage tanks.
BREF	Best available techniques reference document.
BSS	Boosted suction system.
Bund	A tank farm bund (or dike) is designed to contain large spills, such as that caused by a shell rupture or a large overflow. The bund consists of a wall around the outside of the tank (or tanks) to contain any product in the unlikely event of a spill. The bund is typically constructed of well-compacted earth or reinforced concrete. The volume is normally sized to accommodate the contents of the largest tank within the bund.
Calibration	Set of operations that establishes, under specific conditions, the systematic difference that may exist between the values of a parameter to be measured and those indicated by a measuring system (with the corresponding values given in reference to a specific 'reference' system, including reference materials and their accepted values). NB: The result of a calibration allows either the assignment of values of the parameters to be measured to the indication or the determination of corrections with respect to indications.
Carcinogenic material	A material that is known to cause cancer in man.
Casting (noun)	General term used for products at or near their finished shape, formed by solidification of a metal or alloy in a mould (ISO 3134-4: 1985).
Cathode	A negative electrode.
Cation	A positively charged ion - an ion that is attracted towards the cathode in electrochemical reactions.
Caustic soda	Sodium hydroxide.
CEFIC	European Chemical Industry Council (from its French name Conseil Européen des Fédérations de l'Industrie Chimique)
CEN	Comité Européen de Normalisation (European Committee for standardisation).
CFD	Computerised fluid dynamics - a modelling technique used to predict gas flow and temperature in incinerators and other systems.
COD	Chemical oxygen demand indicating the amount of chemically oxidisable organic matter in waste waters (normally referring to analysis with dichromate oxidation) according to ISO 15705:2002.
Combustible material	A material that will continue to show a combustive reaction with air of normal composition and pressure even after the source of ignition is removed.
Compliance assessment	Process to compare actual emissions of pollutants from an installation (manufacturing unit) with the permitted emission limit values within a defined degree of confidence.
Component	Substance imbedded in a mixture, e.g. in waste water, waste gas or air.
Composite sample	Sample prepared by an operator or by an automatic device and that has been obtained by mixing several spot samples.
Concentrate	Marketable product after separation in a mineral processing plant with increased grade of the valuable mineral.
Content	Matter contained in a medium.
Cooling water	Water used for energy transfer (cooling, heating), which is kept in a network separated from industrial water and which can be released back to receiving waters without further treatment.
Cross-media effects	Possible shift of environmental pressure from one environmental compartment to another. Any side-effects and disadvantages caused by the implementation of the technique.
Crushing	This is accomplished by the compression of ore against rigid surfaces, or by impact against surfaces in a rigidly constrained motion path.
CTO	Catalytic thermal oxidiser.
CV	Calorific value, e.g. in MJ/kg.
CWPB	A centre-worked prebaked anode cell.

Terms used	Definition
Daily production capacity	The weight of products (air dry mass) an installation can produce during one day.
DC	Direct current (electrical supply).
DCS	The distributed control system is used to control the material feed rate, critical process and combustion conditions and the addition of gases.
Decommissioning	The shutdown of an installation including decontamination and/or dismantling.
Defrosting	The removal of frost from raw materials.
Degreasing	Eliminating, as far as possible, oil or grease from a component.
De novo synthesis	The mechanism via which fine carbon particles react with inorganic chlorides or organically bound chlorine in the temperature range of 250 °C to 500 °C to produce PCDD/F. This process is catalysed by the presence of metals such as copper or iron.
DeSO _x	A desulphurisation technique.
Destruction	For example, destruction of waste - this refers to the process of chemical conversion of mainly molecular organic species contained in the waste. Carbohydrates, for example, are converted into oxides of carbon and hydrogen.
Dewatering	Process of removing water from an underground mine or open pit, or from the surrounding rock or non-lithified area. The term is also commonly used from the reduction of water content in concentrates, tailings and treatment sludges.
Diffuse emission	Emissions arising from direct contact of volatile or light dusty substances with the environment (atmosphere, under normal operating conditions). These can result from: <ul style="list-style-type: none"> • inherent design of the equipment (e.g. filters, dryers); • operating conditions (e.g. during transfer of material between containers); • type of operation; • a gradual release to other media (e.g. to cooling water or waste water).
DIN	Deutsches Institut für Normung (German national organisation for standardisation).
Dioxins (PCDD/F)	Polychlorinated dibenzo-dioxins (PCDD) and polychlorinated dibenzofurans (PCDF).
Direct measurements	Specific quantitative determination of the emitted compounds at the source.
Discharge	Physical release of a pollutant through a defined outlet, i.e. channelled system, e.g. sewer, stack, vent, curbing area, outfall.
Disposal	Defined by the EC Waste Framework Directive.
Dolomite	Type of limestone, the carbonate fraction of which is dominated by the mineral dolomite, calcium magnesium carbonate (CaMg(CO ₃)).
DON process	Direct Outotec Nickel process.
Drainage	Natural or artificial removal of surface and subsurface water from an area, including surface streams and groundwater pathways.
Driving force for implementation	Reasons for implementation of the technique, e.g. other legislation, improvement in production quality.
Dross	The scum or refuse matter which is thrown off, or falls from, metals in smelting the ore, or in the process of melting. In the chapter for aluminium, the term skimmings/dross is used.
Drum	A cylindrical closed container rotating on an axis.
DSA	Dimensionally stable anodes - metal anodes that are not consumed during use as graphite anodes are hence dimensionally stable.
Dust	Solid particles with a size ranging from submicroscopic to macroscopic of any shape, structure or density, dispersed in the gas phase.
EAA	European Aluminium Association
EAF	Electric arc furnace.
EB	Electron beam.
ECGA	European Carbon and Graphite Association

Terms used	Definition
ECI	European copper institute.
Economics	Information on costs (investment and operation) and any possible savings, e.g. reduced raw material consumption, waste charges, also as related to the capacity of the technique.
EEA	European Environment Agency.
EEB	European Environmental Bureau
Efficiency	A measure of the effectiveness of a technique to achieve a particular result. In some cases, it may be expressed as a ratio of input to output.
Effluent	A physical fluid (air or water together with contaminants) forming an emission.
Electrode	A conductor by which an electric current enters or leaves an electrolyte in an electrochemical reaction (or an electric arc or a vacuum tube) (see also: anode and cathode).
Electrolysis	A process that decomposes a chemical compound or produces a new compound by the action of an electrical current. The electrical current is passed through an electrolytic cell and oxidation/reduction reactions occur at the electrodes; for example, water can be decomposed into hydrogen and oxygen by electrolysis.
Electrolyte	A substance that is capable of conducting an electric current in a solution or fused state.
Electrorefining	An electrolytic refining stage where a metal anode is dissolved and the metal is deposited at the cathode. Impurities called anode slime are deposited in the cell.
Electrowinning (EW)	An electrolytic production stage where an inert metal anode is used and the desired metal in the electrolyte deposited at the cathode.
EMAS	European Eco-Management and Audit Scheme (Council Regulation 761/2001).
Emerging techniques	Techniques with potential for environmental performance improvement but that have not yet been commercially applied or which are still in the research and development phase. Potential future BAT.
Emission factor	The estimated average emission rate of a given pollutant for a given source, relative to units of activity.
Emission pattern	Type of variation of emission over time, for example, emissions can be stable, cyclic, random peaking, random variable, erratic.
Emission to air	Mass of emitted substances expressed in: a) Concentration: mass of emitted substance related to the volume of waste gas under standard conditions (273 K, 101.3 kPa), after deduction of water vapour content, expressed in the units g/Nm ³ , mg/Nm ³ , µg/Nm ³ or ng/Nm ³ . b) Mass flow: mass of emitted substances related to time, expressed in the units kg/h, g/h or mg/h. c) Specific emission: ratio of mass of emitted substances to the mass of products generated or processed (consumption or emission factors), expressed in the units kg/t, g/t or mg/t or µg/t.
Emission to water	Mass of emitted substances related to the volume of waste water, expressed in the units (g/m ³), (g/l), (mg/l) or (µg/l).
EMS	Environmental management system.
EN	European Norming or European Norming standard.
End-of-pipe technique	A technique that reduces final emissions or consumption by some additional process but does not change the fundamental operation of the core process.
Environment	Interrelated physical, chemical, biological, social, spiritual and cultural components that affect the growth and development of living organisms.
Environmentally harmful material	A material that can cause acute or chronic effects in ecosystems - the classification of environmentally harmful materials takes place in accordance with the agreements included in the 67/548/EEC Directive.
EPA	Environmental Protection Agency.
EPMF	European Precious Metals Federation
Equivalent parameter	Parameter related to an emission, which provides the same (similar) level of information with the same (similar) level of confidence.

Terms used	Definition
Erosion	Detachment and subsequent removal of either rock or surface material by wind, rain, wave action, freezing, thawing and other processes.
Error	Measurement error - the amount by which an observed or approximate result differs from the true or exact one. These typically result from an inaccuracy or imprecision in the measurement of parameter values.
ESP	Electrostatic precipitator.
EU	European Union.
EU-15	Member States of the European Union before 1 May 2004.
EU-25	Member States of the European Union from 1 May 2004 until 31 December 2006.
EU-27	Member States of the European Union from 1 January 2007 until 30 June 2013.
EU-28	Member States of the European Union from 1 July 2013.
EU ETS	European Union Emissions Trading Scheme.
Euroalliages	Association of European ferro-alloy producers.
Eurometaux	European non-ferrous metals association.
Euromines	European association of mining industries, metal ores and industrial minerals.
Evaporation	Physical process by which a liquid is changed into a gas.
Example plants	Reference to a plant where the technique is reported to be used.
Exhaust gas (or exhaust air)	Gas/air stream coming off a combustion or extraction processes, it may contain gaseous or particulate components. There is no link with exhausting through a stack. (See also flue-gas, off-gas, waste gas).
FGD	Flue-gas desulphurisation.
Fines	Small particle-sized material.
Flue-gas	Mixture of combustion products and air leaving a combustion chamber and which is directed up a stack to be emitted.
Flux	A substance that, even in small quantities, lowers the fusion point of the material in which it is naturally present, e.g. alkalis in clay, or of the material to which it has been added, e.g. borax added to glazes.
FSF	Flash smelting furnace
Fugitive emissions	Emissions which leave a process as a result of lack of containment, or failure of containment.
Furnace	The part of an installation where combustion commences or is carried out. Annex 13.1 of this document reports on the furnaces that are used and gives the definition of abbreviations.
Global warming	Greenhouse effect - the shortwave solar radiation passes through the Earth's atmosphere but after being reradiated by its surface as infrared radiation, some of it is absorbed by gases in the atmosphere causing a rise in temperature (known as global warming). It is calculated that 55 % of global warming is caused by absorption of energy by CO ₂ . The remaining 45 % is caused mainly by energy absorption by methane and damage to the ozone layer as a result of the use of various ozone-depleting-substances (ODS).
Good practice	Approach which provides a good framework to the given activity. It does not preclude other approaches which may be more appropriate for a given requirement.
Grade	Dimensionless proportion of any constituent in an ore, expressed often as a percentage, grams per tonne (g/t) or parts per million (ppm).
Grinding	Comminution process yielding a fine product (< 1 mm), where size reduction is accomplished by abrasion and impact and sometimes supported by the free motion of unconnected media such as rods, balls and pebbles.
Groundwater	Part of subsurface water in the zone of saturation. Distinct from surface water.
Harmful material	A material that, by inhalation or entry via the mouth or skin, can cause disorder of a limited nature.

Terms used	Definition
Hazardous substances	Substances or groups of substances that have one or several dangerous properties such as toxicity, persistence and bioaccumulability, or are classified as dangerous to humans or the environment according to Regulation 1272/2008/EC - Classification, labelling and packaging of substances and mixtures.
HAZOP	Hazard and operability study.
HCN	hydrogen cyanide.
Hearth	Part of a furnace.
HMIP	Her Majesty's Inspectorate of Pollution (UK).
HT	High-tension electricity.
IF	Induction furnace.
ILA	International Lead Association.
Immission	Occurrence and level of polluting substance, odour or noise in the environment.
Impact crusher	In impact crushers, material comminution is accomplished primarily through the impact action of beaters, which hit the pieces of rock free-falling through the crusher chamber and throw them against stationary surfaces at high speed.
IMPEL	European Union Network for the Implementation and Enforcement of Environmental Law.
Inert gas	A gas which is not toxic, which does not support human breathing or combustion and which reacts scarcely or not at all with other substances. Inert gases are mainly nitrogen and the rare gases like helium, argon, neon, xenon, krypton.
IPPC	Integrated pollution prevention and control.
IR	Infrared.
Irony material	Is material that includes discrete iron components as well as the desired metal (Al, Cu).
ISF ISP	Imperial Smelting Furnace or Imperial Smelting Process.
Isokinetic sampling	Sampling technique where the velocity at which the sample enters the sampling nozzle is the same as the flow velocity in the duct.
I-TEQ	International toxicity equivalent.
IZA	International Zinc Association.
Jaw crusher	A machine for reducing the size of materials by impact or crushing between a fixed plate and an oscillating plate.
JRC	Joint Research Centre.
Launder	A channel used to convey molten metal or slag.
LCV	Low calorific value.
Leachate	Solution obtained by leaching, e.g. water that has percolated through soil containing soluble substances and that contains certain amounts of these substances in solution.
Leaching	Passage of a solvent through a porous or crushed material in order to extract components from the liquid phase. For example, gold can be extracted by heap leaching of a porous ore or pulverised tailings. Other methods are tank leaching of ore, concentrates or tailings and in situ leaching.
Leakage	Gaseous or liquid spills out of system/equipment due to system/equipment failure.
L-SX-EW	Leaching-Solvent extraction-Electrowinning.
Liquation	A refining technique that involves heating a molten metal to a temperature at which the solubility of impurities decreases so that they can be separated.
Make-up water	Water added to a process to start or maintain a reaction, prepare a solution, mix reactants, dilute reactants.

Terms used	Definition
Mass balance	Approach to monitoring, consisting of accounting for inputs, accumulation, outputs and the generation or destruction of the substance of interest, and accounting for the difference by classifying it as a release to the environment. The result of a mass balance is usually a small difference between a large input and a large output, also taking into account the uncertainties involved. Therefore, mass balances are only applicable in practice when accurate input, output and uncertainties quantities can be measured.
Matte	A mixture of sulphides that forms when sulphide metal ores containing nickel, copper, cobalt, etc. are smelted.
Measurement	Set of operations for determining the value of a quantity.
Measuring system	Complete set of measuring instruments and other equipment, including all operating procedures used for carrying out specified measurements.
Melting capacity	The aggregate 'plated' capacity of the furnaces at an installation where the hourly rate multiplied by 24 should be used if appropriate.
Metals Environmental Risk Assessment Guidance (MERAG)	Metals Environmental Risk Assessment Guidance (MERAG) was created by a consortium of researchers, metals associations, scientific panel reviewers and governmental reviewers (UK Government, Department for Environment, Food and Rural Affairs (Defra)) for use in chemicals management and environmental quality standard setting for metals and to allow consideration of site-specific conditions by the assessor through the introduction of metal-specific concepts.
Mineral processing (benefaction, ore dressing, mineral dressing, milling)	Processes to produce marketable mineral products (concentrates) from ore. This is usually carried out at the mine site, the plant being referred to as the mineral processing plant (mill or concentrator). The essential purpose is to reduce the bulk of the ore which must be transported to, and processed by subsequent processes, e.g. smelting, by using methods to separate the valuable (desired) minerals from the gangue. The marketable product of this is called 'concentrate'; the remaining material is called 'tailings'. Mineral processing includes various procedures that rely on the mineral's physical characteristics, i.e. particle size, density, magnetic properties, colour, or physico-chemical properties, i.e. surface tension, hydrophobicity, wettability.
Mineral processing plant (mill or concentrator)	Facility where mineral processing is carried out.
Mineral resource	Concentration or occurrence of natural, solid, inorganic or fossilised organic material in or on the Earth's crust in such a form and quantity and of such a grade or quality that it has reasonable prospects for economic extraction. The location, quantity, grade, geological characteristics and continuity of a mineral resource are known, estimated or interpreted from specific geological evidence and knowledge.
Mining	Methods and techniques to extract ore from the ground, including support facilities, e.g. stockpiles, workshops, transport, ventilation, and supporting activities in the mine itself or in the vicinity.
Mining operation	Any extraction of ore from which mineral substances are taken, where the corporate intent is to make an operating profit or build continuously towards a profitable enterprise.
Monitoring	Systematic surveillance of the variations of a certain chemical or physical characteristic of emissions, discharges, consumption, equivalent parameters or technical measures, etc.
Mother liquor	Waste water stream directly arising from a synthesis or chemical reaction, generally highly concentrated in products, starting material or by-products, especially the initial aqueous discharges.
MS	Member State of the European Union.
N	Normal - refers to volume of gases under normal conditions with a temperature of 273.15 K and pressure of 101.325 kPa.
NA	Not applicable (depending on the context).
Nominal capacity	Quantity of production that a unit is able to produce by design at normal operating conditions.
ND	No data.
NFM	Non-ferrous metals (BREF).

Terms used	Definition
NGO(s)	Non-governmental organisation(s).
NJ	New Jersey - a type of distillation column
Non-ferrous material	All materials that are not ferrous.
NMVOC	Non-methane volatile organic compounds.
OBM converter	A bottom-blown converter used for ferro-nickel production.
Off-gas	General term for gas/air resulting from a process or operation (see exhaust gas, flue-gas, waste gas).
Operational	Emissions occurring due to normal operational activities. Frequency, volumes and loads are usually known upfront or can be estimated or scheduled. The above can be used for determining the best ratio of investment vs efficiency when prioritising investments and determining the best applicable emission reduction techniques. Fugitive emissions and pressure relief are considered to be operational since they occur under normal operational circumstances.
Operational data	Performance data on emissions/wastes and consumption, e.g. raw materials, water and energy. Any other useful information on how to operate, maintain and control, including safety aspects, operability constraints of the technique, output quality, etc.
Ore	Mineral or variety of accumulated minerals (including coal) of sufficient value in terms of quality and quantity that it/they may be mined at a profit. Most ores are mixtures of extractable minerals and extraneous rocky material described as 'gangue'.
Osmosis	The passage of a liquid from a weak solution to a more concentrated solution across a semipermeable membrane that allows passage of the solvent (water) but not the dissolved solids.
OSPAR	Oslo and Paris convention for the protection of the marine environment of the North East Atlantic.
Output	Includes the 'waste out' (main output) and the other types of solid residues, emissions, waste water, etc. produced during a waste treatment.
Oxidant	A material that can react highly exothermically when brought into contact with other materials, flammables in particular.
PAH	Polycyclic aromatic hydrocarbons.
PAN	Polyacrylonitrile.
Parameter	Measurable magnitude representing the main features of a statistical group.
Particulate matter (PM)	Total particulate matter refers to all inorganic and organic solid and liquid materials (droplets and aerosols) that may be present in the flue-gas (see also: dust).
PB	Prebaked type of anode.
PCC	Post-combustion chamber - a term applied to the zone after the initial combustion chamber where gas burnout occurs. Also referred to as the secondary combustion chamber or SCC.
PCDD/F	See dioxins
PFPB	Point feed prebaked cells used for primary aluminium electrolysis.
PFC	Polyfluorocarbon: Organo-compound where most of the hydrogens are replaced by fluorine in the aliphatic chain structure. Some of these organic fluorine compounds are known as perfluorinated, which means that all hydrogens have been replaced with fluorine.
pH	Acidity or alkalinity of a solution. It is a number equivalent to the logarithm, to the base of 10, of the reciprocal of the concentration of hydrogen ions in an aqueous solution.
PGMs	Platinum group metals: Ir, Os, Pd, Pt, Rh, Ru.
PLC	Programmable logic control: digital computer used for the automation of industrial processes.
PLS	Pregnant leach solution produced by leaching minerals from a substrate.
PM	See: particulate matter. Precious metals: Ag, Au and PGMs.
PM _x	Particulate matter with an aerodynamic diameter less than or equal to a nominal x micrometres.
PNEC	Predicted no effect concentrations - the concentration at which no toxic effect is observed.

Terms used	Definition
Pollutant	Individual substance or group of substances which can harm or affect the environment.
Pollution (from the IED)	The direct or indirect introduction, as a result of human activity, of substances, vibrations, heat or noise into the air, water or land which may be harmful to human health or the quality of the environment, result in damage to material property, or impair or interfere with amenities and other legitimate uses of the environment.
Pollution source	The emission source. Pollution sources can be categorised as: <ul style="list-style-type: none"> • point, or concentrated sources; • dispersed sources; • line sources, including mobile (transport) and stationary sources; • area sources.
Post-combustion	Ignition and burning of exhaust gas through the injection of air or the use of a burner (e.g. in order to reduce the amount of CO and (volatile) organic compounds).
Primary measure/technique	A measure/technique that in some way changes the way in which the core process operates thereby reducing raw emissions or consumption (see also: end-of-pipe technique).
Production capacity	Production of 'good castings' and capacity based on the theoretical capacity of the foundry if it was operated for 24 hours, provided that it is technically able to operate that way.
PRTR	Pollutant release and transfer register.
Recovery	Defined by the EC Waste Framework Directive. Also used in this document as the treatment for the recovery of, or part of, material from the waste.
Recuperation	The recovery of heat. In this sector, it can be the use of process heat to preheat raw material, fuel or combustion air.
Recuperative burners	These are designed to circulate hot gases within the burner system to recover the heat. See also: regenerative burners.
Recycle	Used in this document with two meanings: <ul style="list-style-type: none"> • the recycling of some part of the waste to another industrial sector; • recycling within the WT installation. <p>The latter is the most commonly used in this document.</p>
Reference conditions	Conditions that are specified, e.g. in connection with operating a process, collecting samples.
Release	Actual discharge (routine, usual or accidental) of an emission into the environment.
Regenerative burners	These are designed to recover heat from hot gases using two or more refractory masses which are alternatively heated and then used to preheat combustion air, see also recuperative burner.
Residue	A material that is not deliberately produced in a production process and may or may not be waste.
RF	Rotary furnace.
RLE	Roast-leach-electrowin.
Reverse osmosis (RO)	See osmosis.
Roll crusher	A type of secondary crusher consisting of a heavy frame on which two rolls are mounted. These are driven so that they rotate towards one another. Rock fed in from above is nipped between the moving rolls, crushed and discharged at the bottom.
RTO	Regenerative thermal oxidiser, a type of afterburner.
Run-off	Part of the precipitation and snowmelt that does not infiltrate but moves as overland flow.
Sampling	Process by which a portion of substance, material or product is removed to form a representative sample of the whole, for the purpose of examination of the substance, material or product under consideration. The sampling plan, the sampling and the analytical considerations should always be taken into account simultaneously.
SCR	Selective catalytic reduction.
Screening	Separating material into size fractions.

Terms used	Definition
Semis	Semi-finished products such as rod, wire, extrusions, ingots, etc. that are used as an input for the production of other finished products.
Separation	Processing methods to separate ore into concentrate and tailings.
Site	Geographical area which may contain more than one installation, plant or facility.
Slag	A vitrified or partially vitrified residue of smelting, containing mostly silicates, the substances not sought to be produced as matte or metal, and having a lower specific gravity than the latter.
Sludge	A suspension with a high solids content such as the type precipitated by sewage treatment.
SNCR	Selective non-catalytic reduction - a process for reducing NO _x emissions whereby nitrogen oxide is converted to nitrogen and water by a reaction with an ammonia reagent at high temperature.
Solubility	Quantity of solute that dissolves in a given volume and type of solvent, at a given temperature and pressure, to form a saturated solution. The degree to which compounds are soluble depends on their ability, and that of other dissolved species, to form ions and aqueous complexes in a particular drainage chemistry.
Specific emission	Emission related to a reference basis, such as production capacity, or actual production.
Specific water consumption	The amount of fresh water consumed during production (surface water, groundwater), which is taken out from external resources. This fresh water demand is related to air dry net production and is expressed as m ³ /t. Fresh water that is only used for cooling purposes, i.e. water that has no contact with fibres and additives, and that is directly discharged into the recipient is not included. Also waste water generated in steam and power plants on site is not included.
Specification	Physico-chemical values given in legislation to certain compounds, e.g. lubricant oils.
SPL	Spent pot lining, the residues of the cathode system in primary aluminium production.
Start-up, shutdown operations	Operation whilst bringing an activity, an equipment item or a tank into or out of service or into or out of an idling state. Regularly oscillating activity phases are not to be considered as start-ups or shutdowns.
SWPB	Side-worked prebaked anode cell.
SX	Solvent extraction.
Tapping	The act of opening of a furnace outlet to remove molten metal or slag.
TBRC	Top-blown rotary converter used for primary smelting of Cu, precious metals and Pb concentrates as well as smelting of waste electronic equipment.
TO	Thermal oxidiser.
TVOC	Total volatile organic compounds, expressed as C.
TROF	Tilting rotary oxy-fuel furnace (has similar uses to the TBRC).
TWG	Technical working group.
Technical oxygen	Oxygen from air that has been separated from nitrogen to give more than 97 % O ₂ ; it is also referred to as tonnage oxygen.
VDI	Verein Deutscher Ingenieure, the association of German engineers.
Vitreous	This term meaning 'glassy' is applied to ceramic ware that, as a result of a high degree of vitrification (as distinct from sintering), has an extremely low porosity.
Vitrification	The transformation of a substance or a mixture of substances into glass or an amorphous glassy matrix.
Volatile organic compound (VOC)	Any organic compound having at 293.15 K a vapour pressure of 0.01 kPa or more, or having a corresponding volatility under the particular conditions of use.
VSS	Vertical stud Søderberg anode cell.
Waste gas	Final gaseous discharge containing volatile organic compounds (VOC) or other pollutants from a stack or abatement equipment into air.
Waste treatment	Any of the installations that perform a waste treatment covered by the scope of this document.

Terms used	Definition
Waste water	Aqueous effluent from chemical processes, product make-up, raw material preparation, equipment cleaning, storage facilities, loading activities. Rainwater and indirect cooling water are not included because of the different definitions in the Member States for waste water. Instead rainwater and its need for treatment is dealt with separately. Cooling water is dealt with in the respective horizontal BREF on Industrial Cooling Systems.
Wet ESP	Wet electrostatic precipitator.
WT	Waste treatment.
WWT	Waste water treatment.
WWTP	Waste water treatment plant.
Yield	Mass ratio of concentrate to feed, calculated on a dry basis and expressed as a percentage.

REFERENCES

- [1] CEN, *EN 1179:2003 Zinc and zinc alloys - Primary zinc*, 2003.
- [2] McLellan et al., *Pollution Control in the Secondary Aluminium Industry*, HMIP (UK), Surrey, 1993.
- [4] Hatch Associates Ltd, *Pollution Control for Secondary Lead Production*, HMIP (UK), 1993.
- [5] B R Lerwill et al., *Pollution Control in the Precious Metals Industry*, HMIP (UK), 1993.
- [6] McLellan and Partners Ltd, *Pollution Control in the Primary Aluminium Industry*, HMIP (UK), Surrey, 1993.
- [7] Metallo-Chimique, *Metallo-Chimique - Operational data of material storage and drying*, 2012.
- [8] Hatch Associates Ltd, *Pollution Control for the Tin, Bismuth and Silicon Industries*, HMIP (UK), 1993.
- [11] Hatch Associates Ltd, *Pollution Control for Primary Zinc Production*, HMIP (UK), 1993.
- [12] HMIP (UK), *Process for the Production of Zinc and Zinc Alloys*, 1994.
- [13] HMIP (UK), *Processes for the Production of Lead and Lead Alloys*, 1994.
- [16] HMIP (UK), *Processes for the Production of Aluminium*, 1994.
- [18] HMIP (UK), *Processes for the Production of Precious Metals and Platinum Group Metals*, 1994.
- [19] HMIP (UK), *The Extraction of Nickel by the Carbonyl Process and the Production of Cobalt and Nickel Alloys*, 1994.
- [21] COM, *Technical BAT Note Heavy Metal Emissions from Non-Ferrous Industrial Plants*, 1991.
- [23] DFIU-University Karlsruhe, *Emission control at stationary sources in Germany; part I - sulphur and nitrogen oxides*, 1996.
- [25] OSPARCOM, *Description of BAT for the Primary Production of Non-Ferrous Metals (Zinc, Copper, Lead and Nickel)*, OSPAR Convention for the Protection of the Marine Environment of the North-East Atlantic, 1996.
- [26] McLellan and Partners Ltd, *Pollution Control in the Copper Industry*, HMIP (UK), Surrey, 1993.
- [27] M. Barry et al., *Study on the Technical and Economic Aspects of Measures to reduce (on the Basis of Best Available Technology) the Pollution of Water and Other Environmental Areas from the Non-Ferrous Metal Industry (Contract B6612-90-006931)*, European Commission (DG XI), 1993.
- [28] OSPARCOM, *Description of Existing Techniques and Best Available Techniques in the Aluminium Electrolysis Industry*, 1997.
- [32] Mantle et al., *Potential for Air Pollution Emissions from the Aluminium Industry and the Best Available Technology for Abatement (final report)*, 1998.
- [34] UNECE, *Heavy Metals Emissions - Long-range Transboundary Air Pollution*, 1995.
- [35] COM, *Panorama of EU Industry 1997 - An extensive review of the situation and outlook of the manufacturing and service industries in the EU*, European Commission - DG III, 1997.
- [37] Ausmelt Ltd., *EAF Dust Processing with Ausmelt Technology*, 1995.
- [40] Ausmelt Ltd., *Treatment of Lead and Zinc Residues using the Ausmelt Process*, 1996.
- [41] Ausmelt Ltd., *Application of Ausmelt Technology to the Recycling of Spent Pot Liner for the Aluminum Industry*, 1996.
- [46] Guindy, M , 'Precious Metals 1996 - Proceedings of the Twentieth International Precious Metals Conference', *International Precious Metals Institute*, 1996, Newport Beach, California.

References

- [47] Järvinen, O, *Wenmec/Outokumpu Technology Update of Current Developments for Anode Slime*, Wenmec Systems Oy, 1995.
- [48] Järvinen, O, *Current Developments for Anode Slime Precious Metals Treatment*, Wenmec Systems Oy, 1994.
- [49] Hyvärinen, O. et al., 'Recovering Selenium from Copper Refinery Slimes', *Journal of Metals*, 1989.
- [52] Newman, C.J. et al., *Kennecott Utah Copper Smelter Modernization*, Kennecott Utah Copper Corporation, Magna, Utah, 1998.
- [54] Biswas, A.K. et al., 'Extractive Metallurgy of Copper', *Pergamon Press*, 1976.
- [55] Kojo, I.V. et al., *Copper Production by Leaching - Solvent Extraction - Electrowinning*, 1994.
- [56] Knuutila, K., *Nickel electrolysis process*, Outokumpu Harjavalta Metals Oy, Finland, 1997.
- [57] Knuutila, K. et al., 'New Nickel Process Increasing Production', *Outokumpu Harjavalta Metals Oy*, Finland, 1996.
- [58] Kojo, I.V. et al., 'Direct Outokumpu Nickel Flash Smelting Process (DON)', *Outokumpu Engineering Contractors Oy*, Finland, 1997.
- [62] Helle, L. et al., 'Copper production by flash-converting technology: process and equipment', *Outokumpu Engineering Contractors Oy*, Finland, 1994.
- [66] George, D.B. et al., 'Modernization of Kennecott Utah copper smelter', *Copper 95 - International Conference*, 1995.
- [72] Shibasaki, T. et al., *Recent Operation at Naoshima with a larger Mitsubishi Furnace Line*, Mitsubishi Materials Corp., Japan, 1993.
- [73] Theodore, L. et al., *Air Pollution Control Equipment*, ETS International, Inc (USA), 1992.
- [74] Startin, A., *Solve your gas filtration problems*, Cerafil (Ceramic Filter Elements), UK, English, 1998.
- [75] Nordheim, E., '(EEA) Minutes from IPPC BREF Notes - Aluminium Expert Group Meeting - Brussels 27 April 1998', *Aluminium Expert Group Meeting*, 1998, Brussels.
- [76] Soud, H.N., *Particulate control handbook for coal-fired plants*, IEA Coal Research, 1993.
- [77] Soud, H.N., 'Developments in particulate control for coal combustion', *IEA Coal Research (UK)*, 1995.
- [81] NRW (D), *NE-Metallindustrie - Betreiberleitfaden für Anlagen zum Gießen in verlorenen Formen - Sandgußverfahren*, 1997.
- [82] NRW (D), *NE-Metallindustrie - Betreiberleitfaden für Anlagen zum Gießen in Dauerformen - Druckgußverfahren*, Ministerium NRW (D), 1997.
- [83] NRW (D), *NE-Metallindustrie - Betreiberleitfaden für Anlagen zum Schmelzen von Schwermetallen*, Ministerium Umwelt, Raumordnung u. Landwirtschaft, 1997.
- [88] Nordheim, E., *Aluminium Expert Group Site Visits*, EEA, 1998.
- [90] Traulsen, H., 'Plant Information - Copper Industry (Draft)', *Copper Expert Group 1998*, 1998.
- [91] OSPARCOM, *BAT for the Preparation of Anodes in the Primary Aluminium Industry*, OSPAR Convention for the Protection of the Marine Environment of the North-East Atlantic, 1992.
- [92] Laine et al., 'The Support of the Nickel and Cobalt Section of the BREF Note', *Ni Expert Group 1998*, 1998.
- [93] García-Agocheaga, B., *Zinc Recovery Processes*, ASER (E), 1998.
- [94] Laine, L., *NI Production*, Outokumpu (SF), 1998.
- [96] Bontoux, L. et al., *The Legal Definition of Waste and its Impact on Waste Management in Europe*, IPTS, European Commission, 1997.

- [97] Lijftogt, J.A. et al, *Dutch Notes on BAT for the Production of Primary Aluminium*, V.R.O.M. (NL), 1998.
- [98] Lijftogt, J.A. et al, *Dutch Notes on BAT for the Production of Primary Zinc*, V.R.O.M. (NL), 1998.
- [99] Hähre, S., *Report on BAT in German Zinc and Lead Production (Draft)*, University Karlsruhe DFIU (D), 1998.
- [102] Hasenpusch, W., 'Precious Metals', *PM Expert Group - Degussa (D)*, 1998.
- [103] COM, 'Personal Discussions', Personal Communication, 1998.
- [104] Ullmann's Encyclopedia, 'Ullmann's Encyclopedia of industrial chemistry', , 1996.
- [106] Raffinot, P., *Environmental Management of Nickel Production*, United Nations Environment Programme, 1993.
- [110] Anthony, T., *Nickel Processing Technology: A Review*, Minerals Industry International, 1997.
- [111] Shunan Denko, Japan, *High-Carbon Ferrochrome Smelting Process Cuts Electric Power Consumption*, 1998.
- [112] Outokumpu Oy (SF), *Outokumpu oy Ferrochrome Process Results in Energy Savings*, Outokumpu Oy, 1998.
- [113] ALFED, *Secondary Aluminium Refining and Remelting*, 1998.
- [114] Eurometaux, *Fabrication of Semi-Finished Products from Copper and Copper Alloys*, Eurometaux, 1998.
- [115] ETSU (UK), *Waste heat recovery from high temperature gas streams*, ETSU (UK), 1996.
- [116] VDI , *VDI (D) 3467 Emission Control - Production of Carbon and Electrographite Materials*, 1998.
- [117] Krüger, J., *Proposal for a BREF-note for Pb, Zn, Cd, Sb*, University of Aachen for Eurometaux, 1999.
- [118] Laheye, R. et al., *Greenmelt: An Environmentally Sound Remelting Concept*, Hoogovens (NL), 1998.
- [119] McLellan, *Electromagnetic Pumping Improves the Efficiency of Melting Aluminium*, ETSU, 1998.
- [120] McLellan, *Electromagnetic Pumping of Aluminium; Audit of Fluxless Melting Technology at Calder Aluminium Ltd., Wellington*, ETSU, 1998.
- [121] Rentz, O. et al., *Report on BAT in German Copper Production (Final Draft)*, University Karlsruhe (DFIU), 1999.
- [122] ETSU, *Oxy-Fuel Melting of Secondary Aluminium*, ETSU, 1994.
- [123] Robson, T.G. et al., *A Review of the Industrial Uses of Continuous Monitoring Systems: Metals Industry Processes*, UK Environment Agency, 1998.
- [125] Euroalliages (B), *Ferromolybdenum Notes*, Euro Alliages (B), 1998.
- [126] Madelin, B. et al., 'Lead blast-furnace evolution: a new approach', *EMC '91: Non-Ferrous Metallurgy*, 1991.
- [127] Chadwick, J., 'Zaldivar Copper Mine', *Mining Magazine*, 1994.
- [128] Davies, N., *Emissions from Carbon Fibre Production*, UK Environment Agency, 1998.
- [130] Eurometaux , 'Eurometaux Copper Industry - Draft Report from IPPC BAT Copper Experts Group Meeting, Hamburg July 1998', *IPPC BAT Copper Expert Group Meeting*, 1998, Hamburg.
- [131] Nordheim, *Aluminium BREF Note - Primary Aluminium Section on Spent Potlinings*, European Aluminium Association, 1998.
- [134] Metallurgical Consulting Traulsen GmbH, 'Technologies Applied Outside the EU and New Technologies (draft 2nd version)', *Eurometaux, Copper Expert Group*, 1998.
- [135] Gershel, T., *Copper and its Alloys*, EMCI, 1998.
- [136] Fugleberg, S., *Finnish Expert Report on BAT in Zinc Production*, Finnish EPA, 1999.

References

- [137] Riekkola-Vanhanen, M., *Finnish Expert Report on BAT in Copper Production and By-Production of Precious Metals*, Finnish EPA, 1999.
- [138] Niemelä, P., *Finnish Expert Report on BAT in Ferrochromium Production*, Finnish EPA, 1999.
- [139] Riekkola-Vanhanen, M., *Finnish Expert Report on BAT in Nickel Production*, Finnish EPA, 1999.
- [140] Ferro-Alloy Expert Group, *BAT for Ferro-Alloy-Production*, Euroalliages (B), 1998.
- [141] Elkem Asa, 'Company Profile Including Development in Stack Emission Filtration Technology', *8th International Ferroalloys Congress*, 1998, Beijing; China.
- [142] Boin, U. et al., *Stand der Technik in der Sekundäraluminiumerzeugung im Hinblick auf die IPPC-Richtlinie*, UBA (A), 1998.
- [145] Dalrymple, I., *Setting New Standards of Performance and Economy for Effluent Treatment and Heavy an Precious Metal Recovery*, EA Technology Ltd. Chester (UK), 1999.
- [146] Kemmer, *The Nalco Water Handbook (2nd edition)*, McGraw-Hill, 1988.
- [148] Kolbeinsen, L. et al., *Energy Recovery in the Norwegian Ferro Alloy Industry*, INFACON (N), 1995.
- [149] Schei, A. et al., *Production of High Silicon Alloys*, Tapir Forlag, Trondheim (N), 1998.
- [150] J.A. Davis, W.R. Hopkins, 'Recent developments in electrometallurgical tank house environmental control', 1994, pp. 86-94.
- [154] Lindstad, T. et al., '10th International Ferro-Alloys Conference', *10th International Ferro-Alloys Conference*, 1994, SINTEF, Trondheim (N).
- [156] VDI , (D) *3478 Part1 and Part2 (Draft 2008-04) Biological Waste Gas Purification - 1 Bioscrubbers and 2 Trickle Bed Reactors*, 2008.
- [157] Winter, B. et al., *Stand der Technik in der Sekundärkupfererzeugung im Hinblick auf die IPPC-Richtlinie*, UBA (A), 1999.
- [158] Petersen, K., *Determination of specific emission values (BAT)*, Umweltbehörde, Hamburg (D), 1999.
- [159] Coulton, G., *IPPC BREF Notes- Refractory Metals (Chromium) and Ferro Alloys (Ferro Titanium)*, London & Scandinavian Metallurgical Co. ltd., 1999.
- [160] Steudtner, *Bericht über die Durchführung von Emissionsmessungen im Rahmen des Projektes RWO an den Dachreitern der Konverterhalle sowie des Nebenhaubenfilters (Esse 48) in der Rohhütte Werk Ost bei der Firma Norddeutsche Affinerie Hamburg*, TÜV Ecoplan, Umwelt GmbH, Mönchengladbach (D), 1998.
- [161] Bobeth, A., 'Precious Metals', *Sächsisches Landesamt für Umwelt und Geologie*, 1999.
- [165] Neuhaus, W., 'Enforcement Programme Concerning Avoidance and Recycling of Waste at non-ferrous Metal Smelting Plants and Foundries in North-Rhine Westphalia', *Global Symposium on Recycling, Waste Treatment, etc.*, 1999.
- [166] Clark, J.H., *Chemistry of Waste Minimization*, Blackie Academic & Professional, 1995.
- [168] Steil, H.U. et al., 'Personal Communication', Personal Communication, 1999.
- [178] UBA (A), *Emissionserklärung Treibacher Chemische Werke*, UBA (A), 1998.
- [183] ABB, *Information on Systems for Pollution Control*, ABB (S), 1999.
- [184] Elkem, *Energy recovery from hot gas in ferroalloy and silicon industry*, Elkem (N), 1999.
- [189] VDI , *VDI 3478 Part 2 Electrostatic Precipitators - Process and Waste Gas Treatment*, Lurgi GmbH, 1998.
- [194] Mezger, G., *German Aluminium Expert Group*, Ministerium für Umwelt und Verkehr Baden-Württemb, 1999.
- [195] Lurgi, A.G. et al., *Cleaning of Process and Waste Gases*, Lurgi AG, 1991.
- [196] Finkeldei, L., 'Personal Discussions', Personal Communication, 1999.

- [197] Kantola, E., *Dust emissions from closed electric arc furnaces for ferro-chrome production*, Lapin Ympäristökeskus, 1999.
- [198] Velten, *Primary Smelter, Converter Secondary Hood System*, Norddeutsche Affinerie, 1999.
- [199] EnviroSense, 'Closed Ferro-Alloy Furnace with Dry Removal', *EnviroSense*, 1995.
- [202] Fundación Entorno, Empresa y Medio Ambiente, *Metalurgia no Férrea*, Tecnología y Gestión de la Innovación S.A., 1999, p. Epígrafes 2.5.a, 2.5b.
- [206] Traulsen, H., *Information on the Copper Industry Section 6 and 7*, Eurometaux Copper Industry Expert Group, 1999.
- [210] Greek State, *Olympias Project*, TVX-Hellas: Greek Directorate for the Environment, 1999.
- [211] VDI, *VDI 2442 Waste gas cleaning - methods of Thermal Waste Gas Cleaning*, VDI (D), 2003.
- [212] VDI, *VDI 2443 Waste-gas purification by oxidative scrubbing*, VDI (D), 1995.
- [213] VDI, *VDI 3674 Waste gas cleaning by adsorption - Process gas and waste gas cleaning*, VDI (D), 1998.
- [214] VDI, *VDI 3476 Part 1 Waste gas cleaning Methods of Catalytic Waste Gas Cleaning - Fundamentals*, VDI (D), 2005.
- [215] VDI, *VDI (D) 3677 Part 1 Filtering separators - Surface filters*, VDI (D), 1997.
- [216] VDI, *VDI (D) 1 3679 part Wet separators for particle collection*, VDI (D), 1998.
- [217] VDI, *VDI (D) 3927 Part 1 and Part 2 Waste gas cleaning 1) Removal of sulphur oxides, nitrogen oxides and halide from combustion flue gases 2) Removal of inorganic and organic trace species from combustion flue gases*, VDI (D), 2004.
- [218] VDI, *VDI (D) 3460 Emission Control - Thermal treatment of waste*, VDI (D), 2002.
- [219] VDI, *VDI (D) 2102 Emission Control 1) Secondary copper smelting and refining plants 2) Copper and copper alloy melting plants*, VDI (D), 2007.
- [226] Nordic Report, *A Nordic contribution concerning the revision of the IPPC Reference Document on Best Available Techniques in the Non Ferrous Metals Industries*, 2008.
- [227] IZA Report, *BREF ChI for zinc*, 2008.
- [228] COM, *F Farrell Mission in BE - Visits to Belgium*, 2007.
- [229] IZA plant data, *Q/A - Aggregated data on local emissions & exposure*, 2008.
- [230] COM, *FF Mission report 2007 for Poland*, 2007.
- [231] COM, *Mission of Frank Farrell to Belgium and Germany 27 to 31 August*, 2007.
- [232] COM, *Spanish Mission - Mission to Aluminium, Copper and Zinc installations in Spain, 4 to 8 February*, 2008.
- [233] COM, *Farrell Nordic Mission - Mission to Norway, Sweden and Finland June*, 2008.
- [234] UBA (D), *UBA Copper, lead, zinc and aluminium. Abschlussbericht. Teil 1, 2, 3 and 4. Kupfer, etc.*, 2007.
- [237] UBA (A), *Austria M168 Medienübergreifende Umweltkontrolle in ausgewählten Gebieten Monographien, M-168, Wien*, 2004.
- [238] ECI, *ECI Copper Installations - Copper Smelters and Refineries in the EU*, 2012.
- [239] ENIA, *ENIA Input*, 2008.
- [240] Nyrstar Budel, *Nl Input on Zn production Installation for the production of Zinc by hydrometallurgical route*, 2008.
- [241] Infomil, *Netherlands SOX paper. Comparison of Cost effectiveness of SO2 reduction emissions measures of aluminium smelters*, 2008.
- [242] Infomil, *Nl Anode Input - Regenerative thermal oxidation (RTO) for a standalone installation for the production of anodes*, 2008.
- [243] France, *French comments on MnFe alloys*, 2008.
- [244] France, *French comments on SiMn*, 2008.

- [245] France, *French Report on De-commissioning*, 2008.
- [246] France, *French Report on SDHL process*, 2008.
- [247] France, *New possible uses of Red Mud, French Report*, 2008.
- [248] UBA (A), *UBA Austria report Rep-0223. Medienübergreifende Umweltkontrolle in ausgewählten Gebieten. Reutte/Breitenwang, 2009"*, 2009.
- [249] Austria, Brixlegg, *Montanwerke_Brixlegg AG_UBA_0208*, 2007.
- [253] Eurometaux, *Sulphuric Acid Plants in the European NFM Industry*, 2008.
- [254] VDI , *VDI (D) 2597 Emission control - Plants for the production of lead and lead alloys*, 2004.
- [255] VDI, *VDI (D) 2576: 2010-01 Emission Control - Carbothermic and Metallothermic Production of Ferro-Alloys and Silicon Metal*, 2010.
- [256] Winter, *Plant visit report AMAG 20071114.doc*, 2007.
- [257] Paul Wurth, 'Primus process', 2008.
- [258] Finland input, *Weak Acid Treatment*, 2007.
- [260] Nyberg et al., *Recent process improvements in the Kokkola Zn-Roaster - Outokumpu*, 2000.
- [261] Nyman et al., *Outokumpu ref - The OutoCompact SX Approach to Copper Solvent Extraction*, 2002.
- [264] Seyer, Chen, *Jarofix - Iron Residues in the Zinc Industry*, 1999.
- [265] AJ Rigby et al, *Porous Plugues in Molten Copper Production and Refining*, 1999.
- [266] Italy , *Italy Report on Desulphurisation*, 2008.
- [267] BEFESA, *BEFESA Comments on Salt Slag*, 2008.
- [268] Belgium, *Conditions Relating to Composition for Use in or as a Building Material*, 2008.
- [269] Broom, *Port Talbot pm10s : A Study into Industrial Source identification, Reduction and Improvement. David Mark Perryman Broom*, 2005.
- [272] Al input, *European Aluminium Association Input to Revision* , 2008.
- [274] COM, *Farrell Mission in Germany and Netherlands, September 2008*, 2008.
- [276] Schmitt G. , *French PCDD/F Report, G. Schmitt*, 2008.
- [277] Heino, *Heino - Industrial Ecology - Finland Paper on Industrial ecology*, 2004.
- [278] Hunsiger et al, *Reduction of Dioxin Formation by the Sulphur Cycle in MSW Incinerator*, 2007.
- [282] KGHM, *Example PM Plant Precious Metals Plant in KGHM Polska Miedz S.A.*, 2008.
- [283] Lahtinen et al, *Zinc Concentrate Leaching*, 2004.
- [284] Riekkola et al., *Talvivaara bioheapleaching June*, 2008.
- [286] OSPAR, *OSPAR Rec 98/2, OSPAR Convention for the Protection of the Marine Environment of the North-East Atlantic*, 1998.
- [288] UK, *Decommissioning Guide*, 2002.
- [289] USEPA , *USEPA Method 1311 and 1312*, 2008.
- [290] COM, *Best Available Techniques (BAT) Reference Document on Emissions from Storage (EFS BREF)*, European Commission, JRC IPTS EIPPCB, 2006.
- [291] COM, *Competitive Report - Competitive Study Non-Ferrous Metals Final report.doc*, 2001.
- [292] Kojo et al., *Copper production with FSF and FCF*, TMS, 2006.
- [293] COM, *JRC Reference Report on Monitoring of Emissions to Air and Water from IED installations (ROM REF)*, European Commission, JRC IPTS EIPPCB, 2017.
- [294] ITRI , *Tin for tomorrow New sources for new applications*, 2012.
- [295] Gaver C. Jr , 'TIN AND TIN ALLOYS - Kirk-Othmer Encyclopedia of Chemical Technology', 2013.
- [296] EAA, OEA, *EAA and OEA proposal for the review of Chapter 4*, 2012.

- [297] Schlesinger. et al., 'Extractive metallurgy of Copper, Fifth Edition', , 2011, pp. 435 - 438.
- [298] Mensink , *RDM paper 2005 - Source Analysis and Emission Abatement Measures for PM10 Hot Spot Regions in Flanders*, 2005.
- [299] COM, *TWG KOM Report*, 2007.
- [301] MERAG, *MERAG Guidance - Metals Environmental Risk Assessment Guidance*, 2007.
- [303] ENVIRONNEMENT CANADA, *Canadian Al Rapport final in French.pdf - Aperçu des émissions de particules et évaluation de la performance et de la faisabilité des technologies de prévention et de contrôle des émissions de dioxyde de soufre pour l'industrie primaire de l'aluminium*, 2008.
- [304] KGHM, *KGHM Lead Report*, 2009.
- [305] Ausmelt, *Ausmelt Lead and Copper Processes and plant list*, 2009.
- [306] COM, *Environment Dioxins Report - Preparatory work for new dioxin measurement requirements for the European metal industry Final Report*, 2007.
- [307] Austria, *Austria BE277, Austrian Report on Dust*, 2006.
- [308] Haavanlammi, *Hydrocopper for treating variable concentrates*, 2007.
- [309] Pekkala, *Performance Highlights of a Modern VSF SX Plant*, 2007.
- [310] Makinen T., Taskinen P., *The State of the Art in Nickel Smelting: Direct Outokumpu Nickel Technology*, 2006.
- [311] Mauschitz, *Emissionen aus Anlagen der österreichischen Zementindustrie*, 2007.
- [312] VDI, *VDI 2286 Part 1 and 2 Emission control in Aluminium Smelting Plants*, VDI, 2008.
- [313] UBA (D) , *UBA DE Sulphur dioxide conversion*, 2009.
- [314] UBA (D), *UBA DE Sulphur dioxide volume reduction data*, 2009.
- [315] Okopol , *Okopol Report - Assessment of the application and possible development of community legislation for the control of waste incineration and co-incineration*, 2007.
- [316] Wedde et al., 'Experiences with High performance Dry and Wet Scrubbing Systems for Potlines (Dry and Wet Scrubbing)', 2004.
- [317] UBA (D), *Requirements on the measurement of air pollutants with relevance within the scope of the BREF NFM*, 2009.
- [318] Hagen et al., 'Results of operating an RTO based Fume treatment system from Baking Furnaces (Fume treatment from Baking Furnaces).', 2007.
- [319] Boonstra, 'Biotechnology for Sustainable Hydrometallurgy', 2003.
- [320] Huisman, 'Biologically produced Sulphide for Purification of Process streams, effluent treatment and recovery of metals', 2004.
- [321] Weijma, 'Solutions in Practice for Removal of Selenium and Molybdenum', 2007.
- [322] CEN , *Fugitive Dust emission rate estimates by Reverse Dispersion Modelling (15445)*, 2008.
- [323] VDI , *4285 part 1 and 2 - Determination of Diffuse Emissions by Measurements Part 1 - Basic Concepts Part 2 - Industrial Halls*, 2008.
- [324] VDI 3790 part 3, *Emission of gases, odours and dusts from diffuse sources - Storage, transshipment and transport of Bulk Materials*, 2008.
- [325] Austria, *Austrian RTO for secondary lead smelter*, 2009.
- [326] Daum et al., 'High Concentrated SO₂ - How to process these gases', *EMC 2005*, 2005.
- [327] Gnoinski et al., 'Highlights and hurdles in Zinc production by solvent extraction', *ISEC 2008*, 2008.
- [328] Winter B., et al., *Cross-Media - Environmental Control In Selected Area. Emissions from Refractory Metal Production*, 2009.
- [329] Magnus and Olsson, *Recent Developments on the Peirce-Smith Converting Process at the Rönnskär Smelter*, 2007.
- [330] Petola H. et al., Patent for mercury removal , 1985.
- [331] Chmielarz A. et al., *FGD process for NFM and Site Visits by FF*, 2009.

- [332] COM, *Best Available Techniques (BAT) Reference Document for the Management of Tailings and Waste Rock in Mining Activities (MTWR BREF)*, European Commission, JRC IPTS EIPPCB, 2009.
- [333] COM, *Best Available Techniques (BAT) Reference Document for Energy Efficiency (ENE BREF)*, European Commission, JRC IPTS EIPPCB, 2009.
- [335] VMM, *Luchtkwaliteit in het Vlaamse Gewest*, 2011.
- [336] COM, *Reference Document on Economics and Cross-Media Effects (ECM REF)*, European Commission, JRC IPTS EIPPCB, 2006.
- [337] K. Aasly, *Properties and behaviour of quartz for the silicon process*, Norwegian University of Science and Technology, 2008.
- [339] COM, *Best Available Techniques (BAT) Reference Document for the Manufacture of Large Volume Inorganic Chemicals - Ammonia, Acids, Fertilisers (LVIC-AAF BREF)*, European Commission, JRC IPTS EIPPCB, 2007.
- [340] ILA, ILA comments on D3, 2013.
- [341] COM, *Best Available Techniques (BAT) Reference Document for the Waste Treatments Industries (WT BREF)*, European Commission, JRC IPTS EIPPCB, 2006.
- [342] COM, *Best Available Techniques (BAT) Reference Document for Industrial Cooling Systems (ICS BREF)*, European Commission, JRC IPTS EIPPCB, 2001.
- [344] Outotec, 'Outotec cost estimation for acid plant retrofitting', Personal Communication, 2010.
- [345] UBA (D), *Data from UBA DE from the comments on the first and second drafts (Additional Data from UBA DE)*, 2009.
- [346] Eurometaux, *Techniques and emission data from treating low-strength SO₂ gases (SO₂ low strength treatment - emission data)*, 2010.
- [347] Alcoa, *SO₂ Emissions ALCOA Europe*, 2010.
- [348] Solios, 'Correspondence from Fives Solios to the French Ministry (French input for Aluminium)', Personal Communication, 2010.
- [350] Heegaard, *Arc Fume process - The plasma arc fuming process for external recovery of EAF dust*, 2009.
- [351] COM, *Mission to Poland 2009*, 2009.
- [355] NERC, 'Ocean Acidification', 2010.
- [356] ENIA, *ENIA emission data for the nickel industry*, 2008.
- [357] VDI, *VDI 2286 Part 1 - Emission control in Aluminium Reduction Plants*, VDI/DIN, 1998.
- [358] CLC, *Solvent extraction in Cobre las Cruces hydrometallurgical process*, 2012.
- [359] Tsakiridis, 'Aluminium salt slag characterization and utilization – A review', 2012.
- [360] Germany, Germany comments on D3, 2013.
- [361] Spain, Spain comments on D3, 2013.
- [363] Brown et al., *European Mineral Statistics 2007-11*, 2013.
- [364] Metallo-Chimique, *Comparison between lead and tin vapour pressures*, 2014.
- [365] Karuppanan et al., 'Analyzing of Soderberg Cell Technology Performance and Possibilities', 2002.
- [366] International Aluminium Institute, *Results of the 2012 Anode Effect Survey*, 2013.
- [367] Authier-Martin et al., 'The Mineralogy of Bauxite for Producing Smelter-Grade Alumina', 2001.
- [368] Haberl A. et al., 'Dry and wet Scrubbers for High-Amperage Pots: Some recent developments', 2002.
- [369] Treibacher Industries AG, *Reporting data for Non Ferrous Metals Industries BREF Ferro-alloy Plant and premelt plant*, 2008.
- [370] France, French comments on NFM D2, 2009.

- [371] Pekka et al., 'Formation, characteristics and utilisation of CO-gas formed in ferro-chromium smelting', 2014.
- [372] BMG Metall und Recycling GmbH, *Aktualisierte Umwelterklärung 2010/9/7*, 2010.
- [373] Grådahl et al., 'Reduction of emissions from ferro-alloy furnaces', *Infacon XI*, 2007, pp. 479-488.
- [374] COM, *Best Available Techniques (BAT) Reference Document in the Non-ferrous Metals Industries (NFM BREF)*, European Commission, JRC IPTS EIPPCB, 2001.
- [375] Mannweiler et al., 'An anode plant in urban areas: Fiction or reality?', *ARABAL*, 2006, Sharm El-Sheikh, April 2006.
- [376] Regain, *Aluminium Smelters as a Source of Fuel & Mineralizing Materials*, 2011.
- [377] ILA, ILA comments on D3, 2013.
- [378] Industrial NGOs, *NFM data collection*, 2012.
- [379] Sweden, Sweden comments on D3, 2013.
- [380] European Aluminium Association, *EAA sustainability report*, 2012.
- [381] ECGA, ECGA proposal for the review of NFM BREF, 2012.
- [382] Holding, 'Copper worldwide July/August 2012, Metallic Media Ltd ISSN 2046-9438', 2012.
- [383] Copper subgroup, Copper subgroup proposal for techniques to consider in the determination of BAT section, 2012.
- [384] Italy, Italian comments on D3, 2013.
- [385] Germany, German plants emissions data, 2012.
- [386] EAA, EAA proposal based on B. E. Raahaughe, F L Smidth Metal Bulletin, Alumina and Bauxite Conference, March 2011, 2012.
- [387] EAA, *Bauxite Residue Management: Best Practice*, 2013.
- [388] Finland, Finland Comments on D3 - based on Klett C, Missalla M, Bligh R, Improvement of product quality in circulating fluidized bed calcination, Light Metals 2010 TMS , 2013.
- [389] EAA, EAA proposal based on D. Thomas "Heat transfer in the Bayer process", Light Metals 2010, TMS, pg 161 - 166, 2012.
- [390] France, France plants emissions data, 2012.
- [391] The Netherlands, The Netherlands plants emissions data , 2012.
- [392] UK, The United Kingdom plants emissions data, 2013.
- [393] Austria, Austria plants emissions data, 2012.
- [394] Schmitz, *Handbook of aluminium recycling*, 2006.
- [395] France, France comments on D3, 2013.
- [396] Italy, Italy plants emissions data, 2012.
- [397] ILA, ILA proposal for the revision of Chapter 5, 2012.
- [399] IZA, IZA proposal for the revision of Chapter 6, 2012.
- [400] IZA, IZA comment on D3, 2013.
- [401] Houten et al., 'Long-term performance and microbial community analysis of a full-scale synthesis gas fed reactor treating sulfate- and zinc-rich wastewater', 2009.
- [402] Buisman et al., 'BIOLOGICAL SULFIDE PRODUCTION FOR METALRECOVERY', , 1999.
- [403] EPMF, EPMF plants emissions data, 2008.
- [404] EPMF, EPMF proposal for the revision of Chapter 7, 2012.
- [405] Euroalliages, Euroalliages proposal for the revision of Chapter 9 , 2012.
- [406] Greece, Greece comments on D3, 2013.
- [407] Euroalliages, Euroalliages comments on D3 , 2013.
- [408] Kadkhodabeigi M., *Modelling of Tapping Processes in Submerged Arc Furnaces - Norwegian University of Technology NTNU*, 2011.

References

- [409] Finland, Finland comments on D3, 2013.
- [410] Mäkinen et al., 'Outokumpu's technologies for efficient and environmentally sound nickel production, COM 2005 Canada', 2005.
- [411] Taskinen et al., 'Oxygen pressure in the Outokumpu flash smelting furnace- Part 2: the DON process, Transactions of the Institution of Mining and Metallurgy, Section C 110 (May-August 2001) C101-C108', 2001.
- [412] Norwegian Environment Agency , <http://www.norskeutslipp.no> open database maintained by Norwegian Environmental Authorities that contains all emission data reported to authorities for Xstrata Nikkelverk AS from 2002 and onwards , 2012.
- [413] Warner et al., 'JOM World Nonferrous Smelter Survey Part IV: Nickel: Sulphide, JOM April 2007', 2007.
- [414] Peek et al., 'Technical and Business Considerations of Cobalt Hydrometallurgy, Journal of Metals, Vol 61, No. 10, 2009, pp. 43-52', , 2009.
- [415] Nickel Institute, Nickel Institute comments on D3 , 2013.
- [416] UK, The United Kingdom comments on D3 , 2013.
- [417] IAF, International Accreditation Forum website , 2010.
- [420] EC, 'Regulation (EC) No 1221/2009 of the European Parliament and of the Council of 25 November 2009 on the voluntary participation by organisations in a Community eco-management and audit scheme (EMAS), repealing Regulation (EC) No 761/2001 and Commission Decisions 2001/681/EC and 2006/193/EC', *Official Journal of the European Union*, Vol. L 342, 22.12.2009, 2009, pp. 1-45.
- [424] Asturiana de Zinc, *Photo of landscape restoration ongoing with Jarofix*, 2014.
- [426] GFMS, *World Silver Survey 2012 A Summary*, 2012.
- [428] COM, *Best Available Techniques in the Smitheries and Foundries Industry*, 2005.
- [429] Eurometaux, 'Updated figure of the NFM sector', Personal Communication, 2016.
- [430] CEN, *EN ISO 14001:2015 Environmental management systems – Requirements with guidance for use*, 2015.

***Europe Direct is a service to help you find answers
to your questions about the European Union.***

**Freephone number (*):
00 800 6 7 8 9 10 11**

(*) The information given is free, as are most calls (though some operators, phone boxes or hotels may charge you).

More information on the European Union is available on the internet (<http://europa.eu>).

HOW TO OBTAIN EU PUBLICATIONS

Free publications:

- one copy:
via EU Bookshop (<http://bookshop.europa.eu>);
- more than one copy or posters/maps:
from the European Union's representations (http://ec.europa.eu/represent_en.htm);
from the delegations in non-EU countries (http://eeas.europa.eu/delegations/index_en.htm);
by contacting the Europe Direct service (http://europa.eu/europedirect/index_en.htm) or
calling 00 800 6 7 8 9 10 11 (freephone number from anywhere in the EU) (*).

(*) The information given is free, as are most calls (though some operators, phone boxes or hotels may charge you).

Priced publications:

- via EU Bookshop (<http://bookshop.europa.eu>).

JRC Mission

As the science and knowledge service of the European Commission, the Joint Research Centre's mission is to support EU policies with independent evidence throughout the whole policy cycle.



EU Science Hub
ec.europa.eu/jrc



@EU_ScienceHub



EU Science Hub - Joint Research Centre



Joint Research Centre



EU Science Hub

